



AIRCHARGER™

HIGH-FLOW INTAKE KITS

INSTALLATION INSTRUCTIONS

63-9031-1

TOYOTA

2007-11 Tundra

2008-11 Sequoia

V8-5.7L

NOTE: This kit was not designed to fit vehicles with a body lift.

TOOLS NEEDED:

- 10mm Wrench
- 13mm Wrench
- 10mm Socket
- 3mm Allen Wrench
- 4mm Allen Wrench
- Flat Blade Screwdriver
- Phillips Screwdriver
- 5/8" Wrench
- Extension
- Ratchet

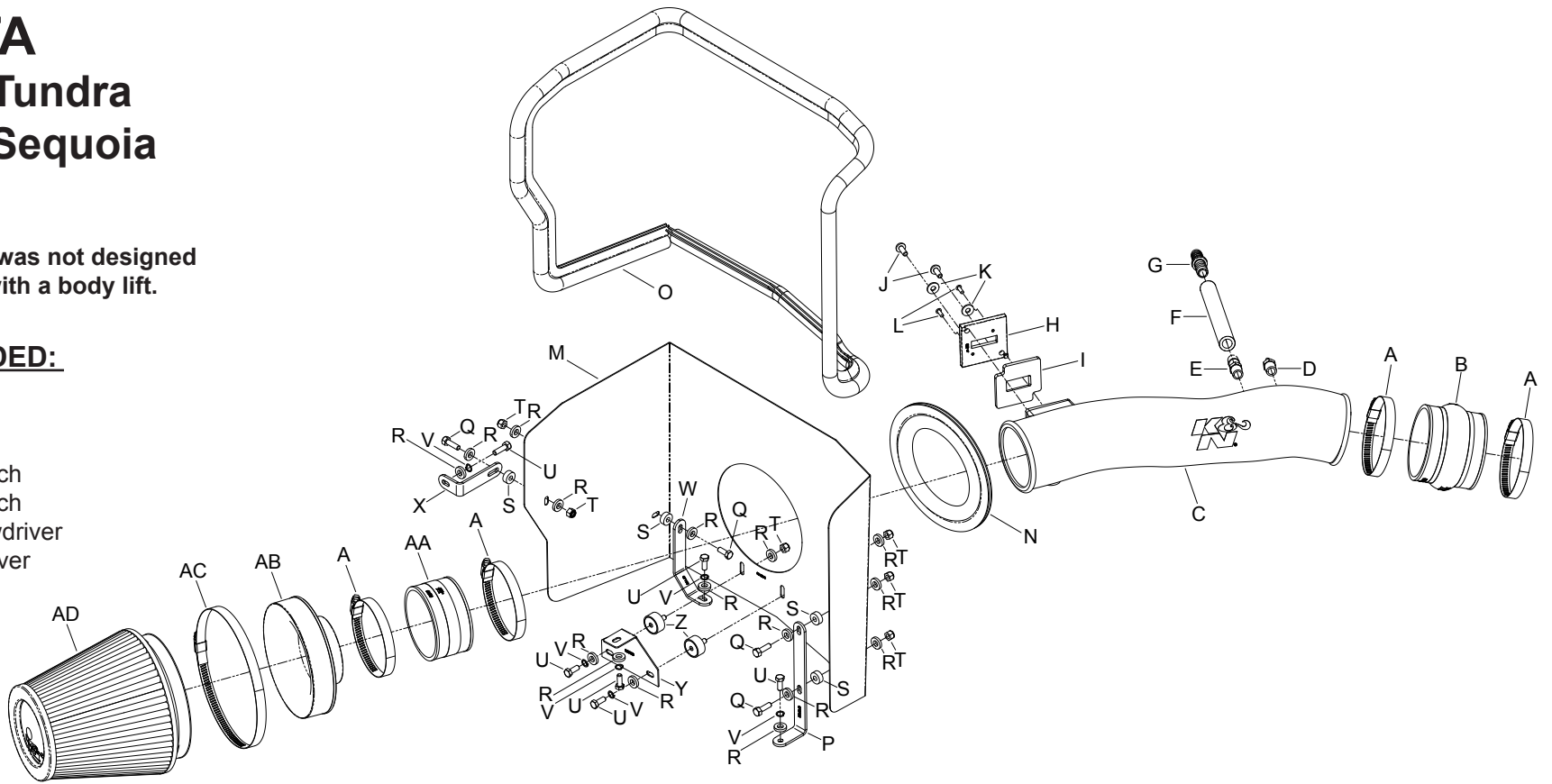

PARTS LIST:

Description	Qty.	Part #	Description	Qty.	Part #	Description	Qty.	Part #
A Hose Clamp #56	4	08620	K Washer; 6MM Flat, SS	2	08269	U Bolt; 6MM-1.00 X 16MM, SS	6	07812
B Hose; 3-1/2"ID X 3" L HUMP	1	084057	L Screw; M4- .7 X 12, Bttn Hd	2	07726	V Washer; 1/4" Lock, ZN	6	08198
C Intake Tube	1	087214-1	M Heat Shield	1	07653-1	W Bracket; Mild STL, FB/PC	1	07190
D Vent; 3/16 Barbed 1/4"NPT	1	080021	N Edge Trim (20")	1	102494	X Bracket; "L"	1	070742
E Vent; 1/2" Hose, 1/4"NPT	1	080022	O Edge Trim (75")	1	102460	Y Bracket; "L", STL, TK/PC	1	083128
F Hose; 1/2"ID X 7"L, Black	1	08159	P Bracket; L-Bend	1	070902	Z Stud; mnt, m/f, 1/2"L X 1"W	2	070228
G Hose; Mender, 1/2" Barbed	1	08686	Q Bolt; M6 X 1.00 X 20MM Hex	4	07795	AA Hose; 3.5"ID X 2"L, Black	1	08630
H Adaptor; Nylon 6/6 GF, Black	1	21515	R Washer; 1/4"ID X 5/8"OD	16	08275	AB Adapter; #380	1	21512 -1
I Gasket; 3/16 Poron	1	09069	S Spacer; .625" OD X .250"ID	4	06555	AC Hose Clamp #104	1	08697
J Bolt; M6 X 1.00 X 16MM	2	07730	T Nut; 6MM Nylock, Hexhead	6	07512	AD Air Filter	1	RF-1042

NOTE: FAILURE TO FOLLOW INSTALLATION INSTRUCTIONS AND NOT USING THE PROVIDED HARDWARE MAY DAMAGE THE INTAKE TUBE, THROTTLE BODY AND ENGINE.

TO START:

1. Turn the ignition off and disconnect the vehicle's negative battery cable.

NOTE: Disconnecting the negative battery cable erases pre-programmed electronic memories. Write down all memory settings before disconnecting the negative battery cable. Some radios will require an anti-theft code to be entered after the battery is reconnected. The anti-theft code is typically supplied with your owner's manual. In the event your vehicles' anti-theft code cannot be recovered, contact an authorized dealership to obtain your vehicles anti-theft code.



2. Lift the front of the engine cover up, then un-hook it from the rear. Remove it from the vehicle.

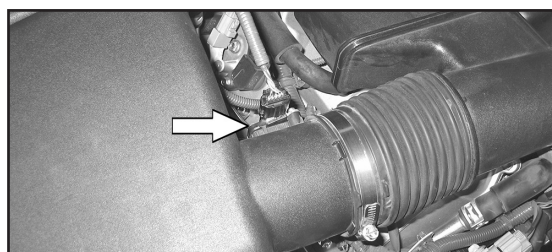

3. Disconnect the mass air sensor electrical connection. Un-hook the wiring harness from the air box.



4. Disconnect the crank case vent hose from the factory intake tube as shown.



5. Disconnect the fuel pressure regulator vent hose from the factory intake tube as shown.



6. Loosen the hose clamp that secures the factory intake tube to the throttle body.

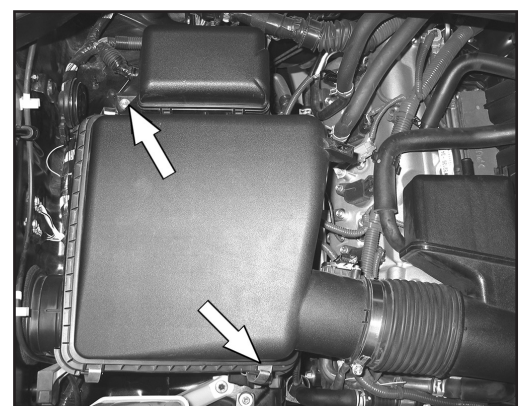

7. Loosen the two bolts that secure the air box to the inner fender.



8. Remove the complete factory intake system from the vehicle.
Note: K&N Engineering, Inc., recommends that customers do not discard factory air intake.

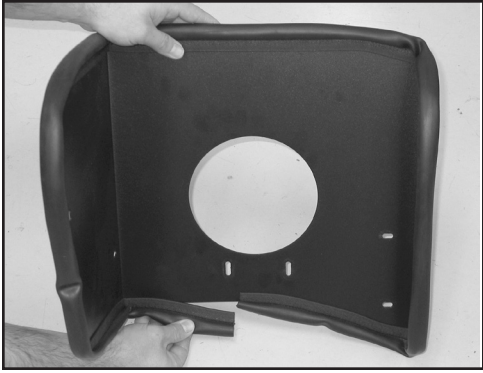

9. Install the large edge trim onto the heat shield as shown.
Note: Some trimming of the edge trim may be necessary.

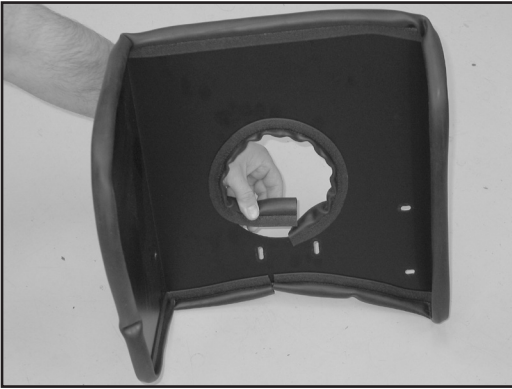

10. Install the small edge trim into the hole of the heat shield as shown.
Note: Some trimming of the edge trim may be necessary.

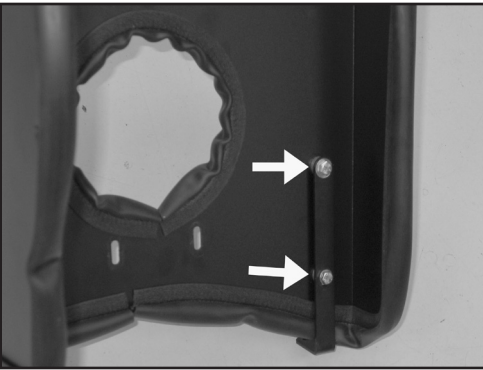

11. Install the large "L" bracket (#070902) onto the heat shield using the provided hardware and spacers as shown.
Note: The two spacers are to be installed between the bracket and heat shield. Do not completely tighten at this time.

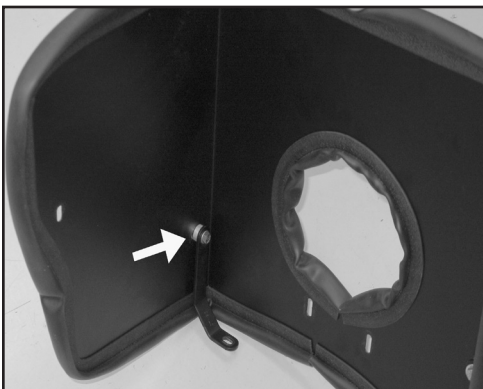

12. Install the small "L" bracket (#07190) onto the heat shield with the provided hardware and spacers as shown.
Note: The spacer is to be installed between the bracket and heat shield. Do not completely tighten at this time.



12a. Install the tube mounting bracket onto the heat shield as shown using the provided hardware.

NOTE: Be sure to place the provided rubber mounted studs between the heat shield and bracket. Do not completely tighten at this time.

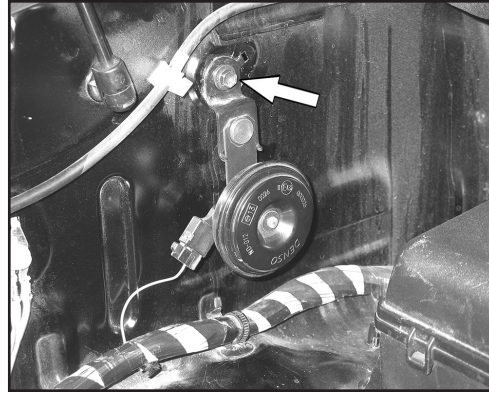

13. On vehicles equipped with a security system horn, remove the bolt that secures the horn to the inner fender.

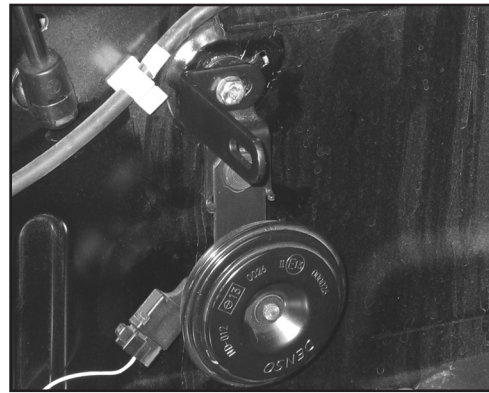

14. Install the small "L" bracket (#070742) onto the inner fender using the provided hardware as shown.
Note: On vehicles equipped with the security system horn, the "L" bracket is to be installed over the horn bracket.

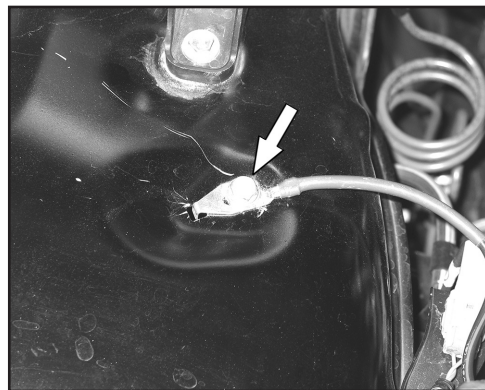

15. Remove the bolt that secures the ground strap to the inner fender.

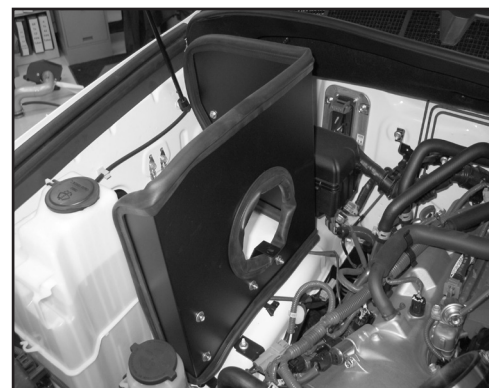

16. Set the heat shield into position on the inner fender. Then, secure the front mounting bracket to the front air box mounting location with the provided hardware.

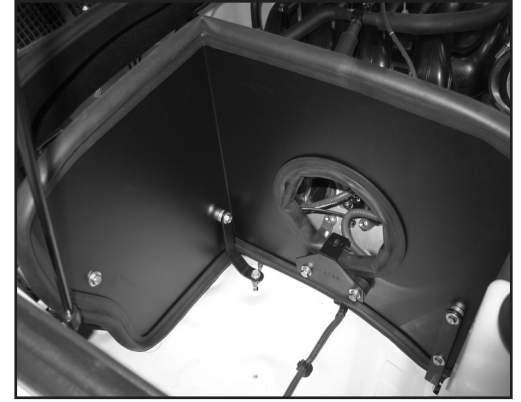

17. Secure the rear lower mounting bracket to the ground strap location with the provided hardware.

Note: The ground strap is to be placed between the bracket and inner fender.

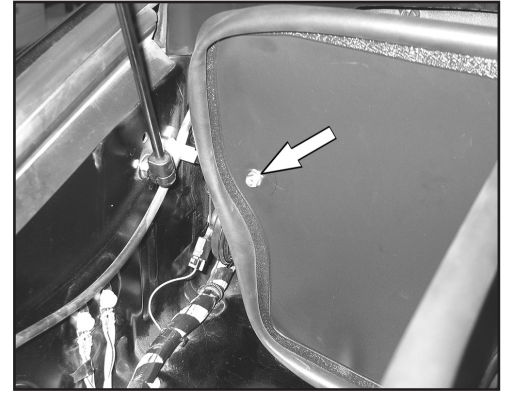

18. Secure the rear heat shield bracket (installed in step #14) to the heat shield with the provided spacer and hardware.
Note: The spacer is to be placed between the heat shield and bracket.

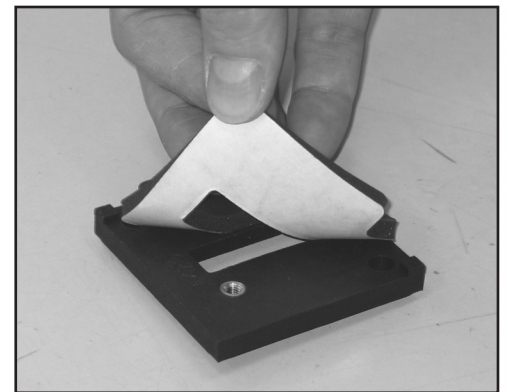

19. Install the provided gasket onto the mass air sensor adapter as shown.

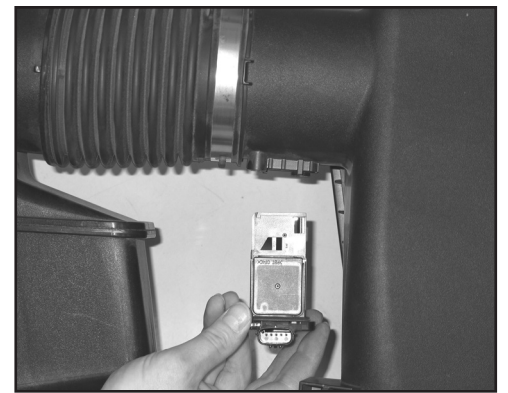

20. Remove the two bolts that secure the mass air sensor into the stock air filter housing. Remove the mass air sensor as shown.

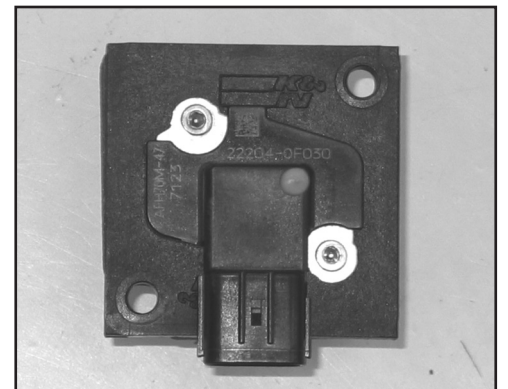

21. Install the mass air sensor into the mass air sensor adaptor and secure with the provided hardware.

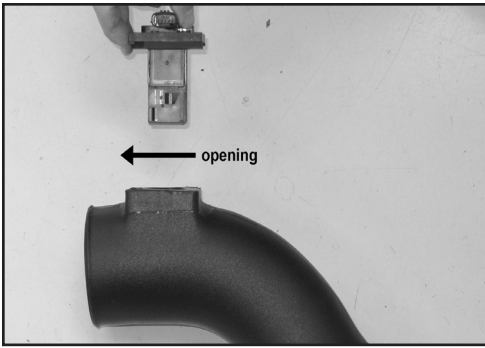

22. Install the mass air sensor assembly into the intake tube and secure with the provided hardware as shown.

Note: The opening in the mass air sensor is to be installed facing towards the inlet end of the intake tube.



23. Install the provided NPT fittings into the intake tube in the positions shown.

NOTE: Plastic NPT fittings are easy to cross thread. Install the vent fitting "hand" tight, then turn it two complete turns with a wrench.

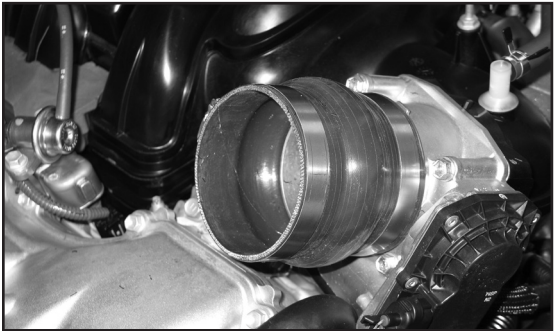

24. Install silicone hose (#084057) onto the throttle body and secure with the provided hose clamp as shown.



25. Install the intake tube into the silicone hose at the throttle body and align with the the bracket installed on the heat shield. Align tube and heat shield then tighten the heat shield and secure the intake tube with the provided hardware.



26. Connect the factory fuel pressure vent hose to the intake tube as shown.

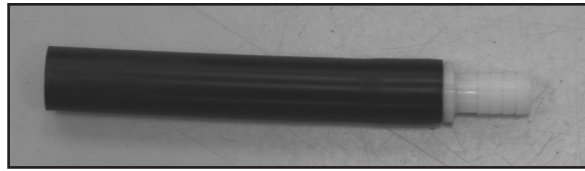

27. Install the provided hose mender into the provided crank case vent hose.

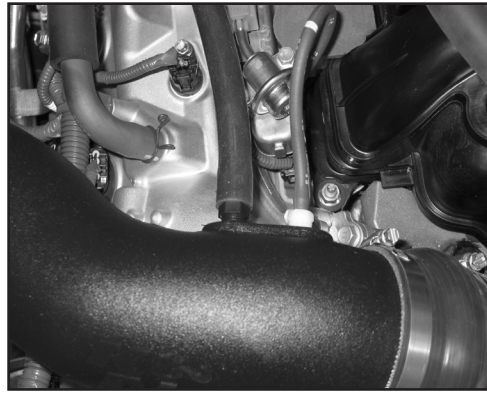

28. Connect the hose mender from the crank case vent hose assembly into the factory crank case vent hose and secure with the factory spring clamp. Then, connect the open end to the intake tube as shown.



29. Install the air filter adapter into the K&N® air filter and secure with the provided hose clamp as shown.



30. Install the provided silicone hose (#08630) onto the air filter adapter and secure with the provided hardware as shown.



31. Install the K&N® air filter assembly onto the intake tube and secure with the provided hose clamp.



32. Re-install the engine cover onto the engine.

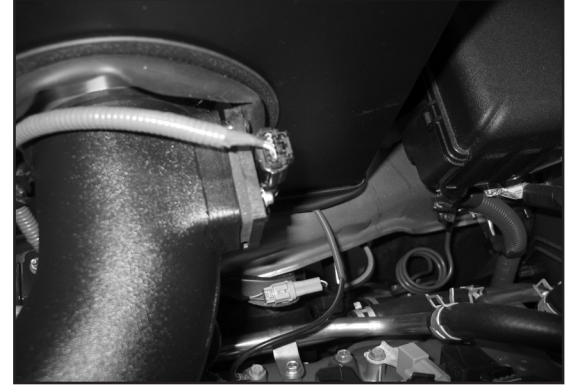

33. Re-connect the mass air sensor electrical connection as shown.

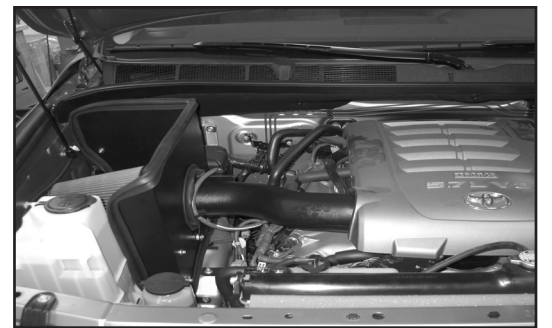

34. Re-connect the vehicle's negative battery cable. Ensure everything is tight and properly positioned before starting the vehicle.

35. It will be necessary for all K&N® high flow intake system to be checked periodically for re-alignment, clearance, and tightening of all connections. Failure to follow the above instructions may void the warranty.

ROAD TESTING

1. Start the engine with the transmission in neutral or park, and the parking brake engaged. Listen for air leaks or odd noises. For air leaks secure hoses and connections. For odd noises, find cause and repair before proceeding. This kit will function identically to the factory system except for being louder and much more responsive.

2. Test drive the vehicle. Listen for odd noises or rattles and fix as necessary.

3. If road test is fine, you can now enjoy the added power and performance from your kit.

4. K&N suggests checking the air filter element periodically for excessive dirt build-up. When the element becomes covered in dirt (or once a year), service it according to the instructions on the Recharger service kit, part number 99-5050 or 99-5000.