



AIRCHARGER™

HIGH-FLOW INTAKE KITS

INSTALLATION INSTRUCTIONS

63-3065

CHEVROLET / GMC / HUMMER

2007-12 Colorado / Canyon

2007-09 H3

L5-3.7L

NOTE: This kit was not designed to fit vehicles with a body lift.

TOOLS NEEDED:

- 2.5mm Allen Wrench
- 10mm Socket
- 13mm Socket
- 10mm Wrench
- Extension
- Flat Blade Screwdriver
- Ratchet
- T-20 Torx Wrench
- Drill Motor
- 1/2" Drill Bit

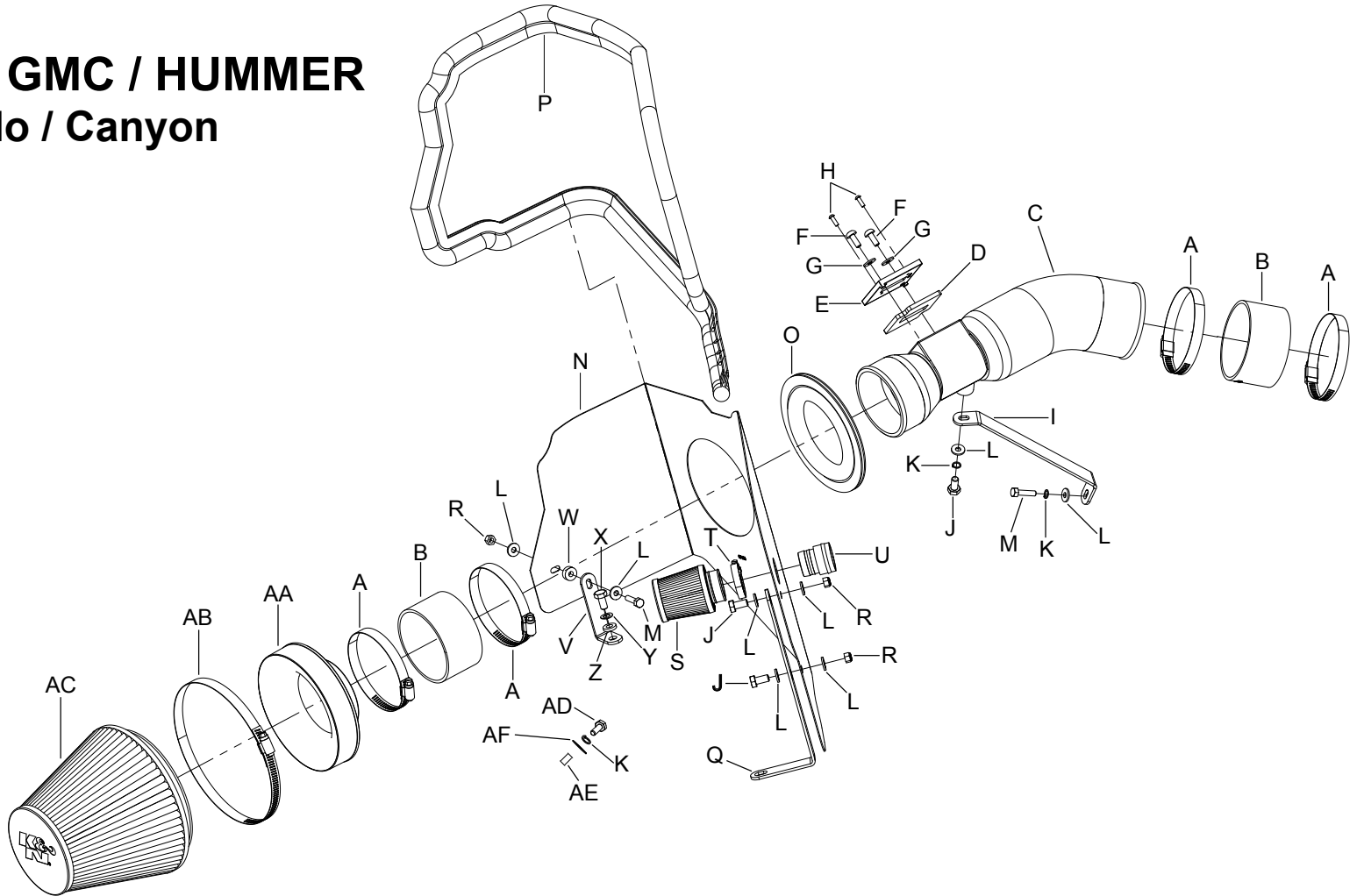

PARTS LIST:

Description	Qty.	Part #	Description	Qty.	Part #	Description	Qty.	Part #
A Hose Clamp #56	4	08620	L Washer; 1/4"ID X 5/8"OD - SAE	8	08275	W Spacer: .625" OD X .250"ID X .250"L Al.	1	06555
B Hose; 3.5" ID X 2"L, Black	2	08630	M Bolt; M6-1.00 X 25mm, SS	2	07858	X Bolt; 8mm-1.25 X 16mm, Hex Head	1	07844
C Intake Tube	1	087219	N Heat Shield	1	07656	Y Washer; 8mm Spring (Wave)	1	08239
D Gasket; 3/16" Poron	1	09069	O Edge Trim (17")	1	102469	Z Washer; 5/16"ID X 5/8"OD, Flat	1	08276
E Adaptor; Nylon 6/6 GF, Black	1	21515	P Edge Trim (61")	1	102492	AA Adaptor; #380	1	21512
F Bolt; M6 X 1.00 X 16mm, Btnhd., SS	2	07730	Q Bracket; Mild STL, FB/PC	1	010060	AB Hose Clamp #104	1	08697
G Washer; 6mm Flat, SS	2	08269	R Nut; 6MM Nylock, Hex Head, SS	3	07512	AC Air Filter	1	RF-1048
H Screw; M4-.7 X 12, Btnhd. SS	2	07726	S Universal Chrome Filter	1	RC-2540	AD Bolt; 1/4 - 20 X 1" L Hex Head	1	08314
I Bracket; "C", STL, FB/PC	1	06495	T Hose Clamp #20 Mini	1	08431	AE Insert; 1/4" - 20 X .5" OD X .785"L	1	081011
J Bolt; 6mm-1.00 X 16mm, SS	3	07812	U Adaptor; 1-1/8"OD Quick Connect	1	088012	AF Washer; 1"D X 15.004 Hole Fender	1	08160
K Washer; 1/4" Lock, ZN	3	08198	V Bracket; "L", Fin.	1	070602			

NOTE: FAILURE TO FOLLOW INSTALLATION INSTRUCTIONS AND NOT USING THE PROVIDED HARDWARE MAY DAMAGE THE INTAKE TUBE, THROTTLE BODY AND ENGINE.

TO START:

1. Turn off the ignition and disconnect the negative battery cable.

NOTE: Disconnecting the negative battery cable erases pre-programmed electronic memories. Write down all memory settings before disconnecting the negative battery cable. Some radios will require an anti-theft code to be entered after the battery is reconnected. The anti-theft code is typically supplied with your owner's manual. In the event your vehicles' anti-theft code cannot be recovered, contact an authorized dealership to obtain your vehicles anti-theft code.



2. Depress the locking clip on the mass air sensor electrical connection, then separate the mass air sensor electrical connection.



3. Depress the locking ring on the air pump fresh air inlet tube. Disconnect the fresh air inlet tube from the upper air box.

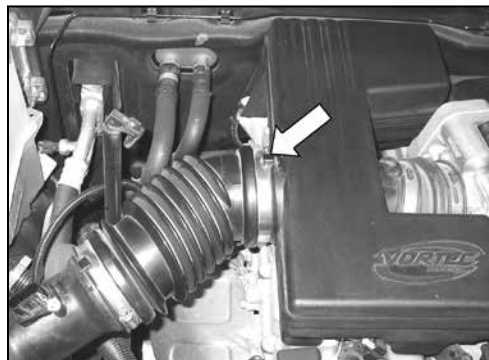

4. Loosen the hose clamp that secures the stock intake tube to the intake resonator.

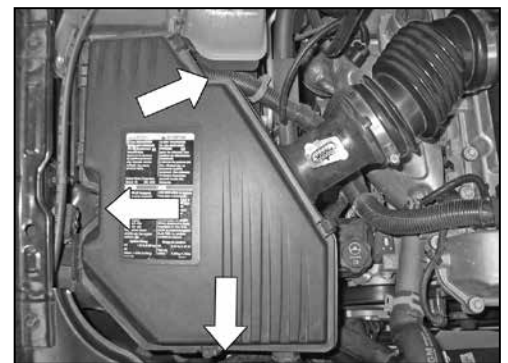

5. Loosen the single retaining nut and two air box retaining bolts.

NOTE: 2008 and later vehicles are not equipped with the mounting nut, all other vehicles will use the nut in a later step.



6. Lift the air box up, removing it from the vehicle as shown.

NOTE: K&N Engineering, Inc., recommends that customers do not discard factory air intake.



7. Install silicone hose (08630) onto the intake plenum and secure with the provided hose clamp as shown.

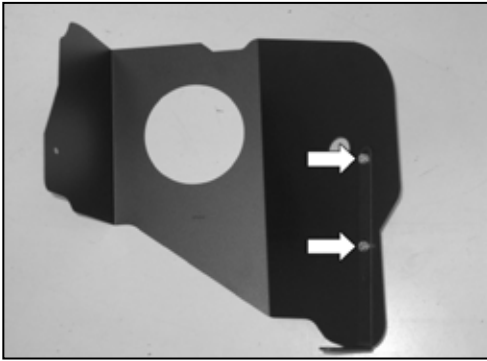

8. Install "L" bracket (010060) onto the heat shield with the provided hardware as shown.

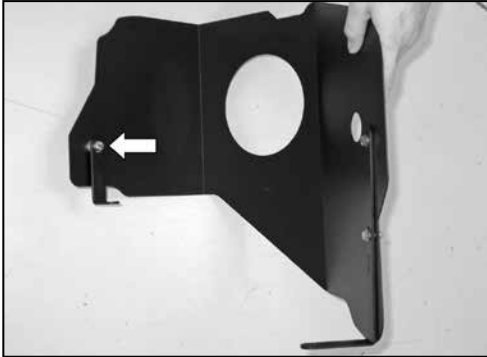

9. Install the small "L" bracket (070602) onto the heat shield using the provided hardware and spacer as shown.

NOTE: The spacer is to be placed between the bracket and heat shield.

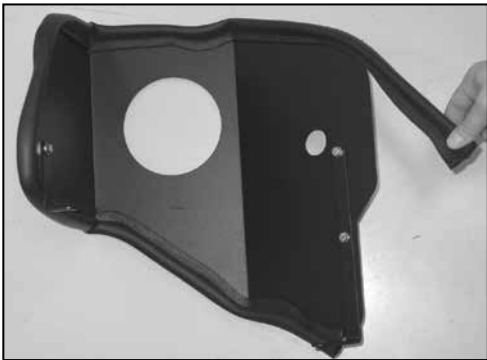

10. Install the long edge trim onto the heat shield as shown.

NOTE: Some trimming of the edge trim may be necessary.



11. Install the small edge trim into the heat shield hole as shown.

NOTE: Some trimming of the edge trim may be necessary.



12. Install the provided adapter into the small heat shield hole as shown.

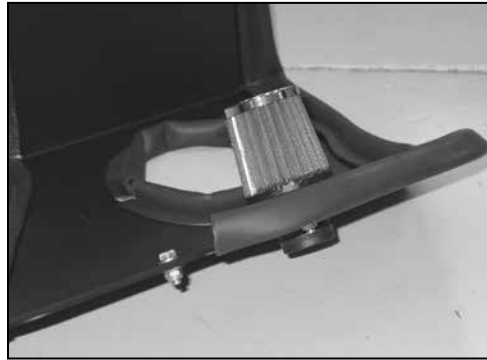

13. Install the provided air pump filter onto the adapter installed in the previous step. Secure with the provided hose clamp.



13a. On vehicles not equipped with the air box mounting stud and nut, drill out the existing hole in the inner fender with a 1/2" drill.



13b. Install the provided inserted nut into the hole drilled in step 13a.

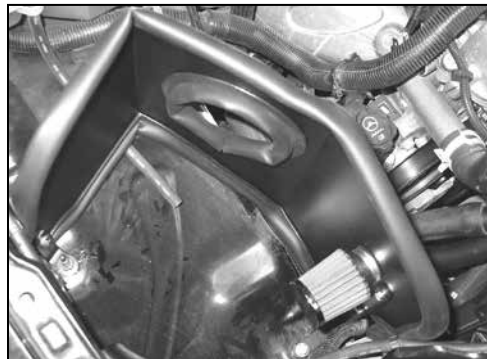

14. Install the heat shield into the vehicle and secure with the provided hardware.

NOTE: On vehicles equipped with the air box mounting stud the factory nut will be reused. The front of the heat shield will secure to the front air box mounting location. The rear of the heat shield will mount to the mounting stud with the factory nut or on 2008 and later vehicles will mount to the inserted nut installed in step 13b.

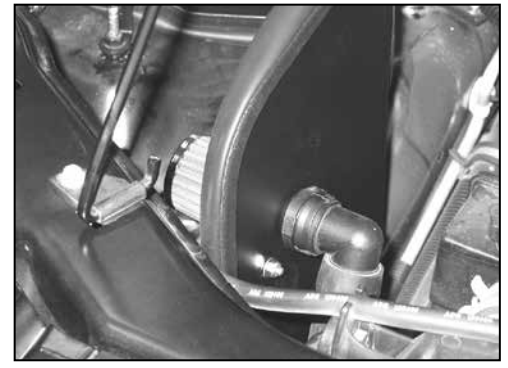

15. Secure the air pump fresh air tube to the adapter as shown.

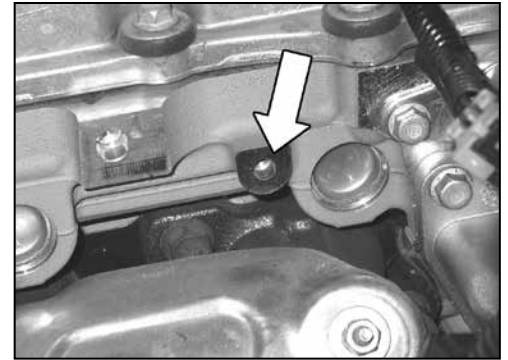

16. Install the tube mounting bracket (06495) onto the cylinder head as shown. Secure with the provided hardware.

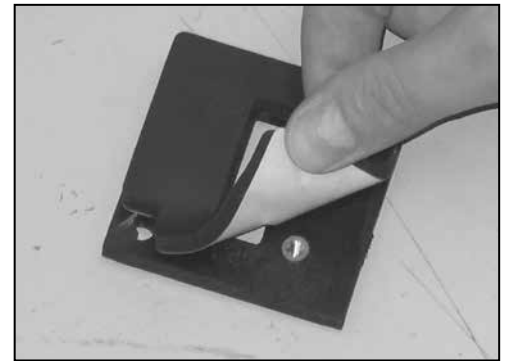

17. Install the provided gasket onto the mass air sensor adapter.



18. Remove the mass air sensor from the vehicle as shown.



19. Install the mass air sensor into the K&N® mass air sensor adapter. Secure with the provided hardware.



20. Install the mass air sensor assembly into the K&N® intake tube and secure it with the provided hardware.

NOTE: The opening in the mass air sensor must face towards the air filter end of the intake tube.



21. Install the K&N® intake tube into the silicone hose at the throttle body and align it with the tube mounting bracket installed in step 16. Secure with the provided hardware and hose clamp.



22. Install the air filter adapter into the K&N® air filter and secure with the provided hose clamp.



23. Install silicone hose (08630) onto the air filter adapter and secure with the provided hose clamp.



24. Install the air filter assembly onto the K&N® intake tube and secure with the provided hose clamp as shown.



25. Re-connect the mass air sensor electrical connection.

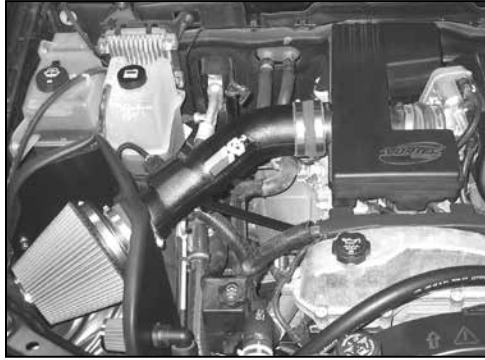

26. Reconnect the vehicle's negative battery cable. Double check to make sure everything is tight and properly positioned before starting the vehicle.

27. It will be necessary for all K&N® high flow intake systems to be checked periodically for re-alignment, clearance, and tightening of all connections. Failure to follow the above instructions and/or improper maintenance may void warranty.

ROAD TESTING:

1. Start the engine with the transmission in neutral or park, and the parking brake engaged. Listen for air leaks or odd noises. For air leaks secure hoses and connections. For odd noises, find cause and repair before proceeding. This kit will function identically to the factory system except for being louder and much more responsive.

2. Test drive the vehicle. Listen for odd noises or rattles and fix as necessary.

3. If road test is fine, you can now enjoy the added power and performance from your kit.

4. K&N Engineering, Inc., requires cleaning the intake system's air filter element every 100,000 miles. When used in dusty or off-road environments, our filters will require cleaning more often. We recommend that you visually inspect your filter once every 25,000 miles to determine if the screen is still visible. When the screen is no longer visible some place on the filter element, it is time to clean it. To clean and re-oil, purchase our filter Recharger® service kit, part number 99-5050 or 99-5000 and follow the easy instructions.