



AIRCHARGER™

HIGH-FLOW INTAKE KITS

INSTALLATION INSTRUCTIONS

63-3059

CHEVROLET / PONTIAC

2006-07 MONTE CARLO

2006-08 GRAND PRIX

2006-09 IMPALA SS

V8-5.3L

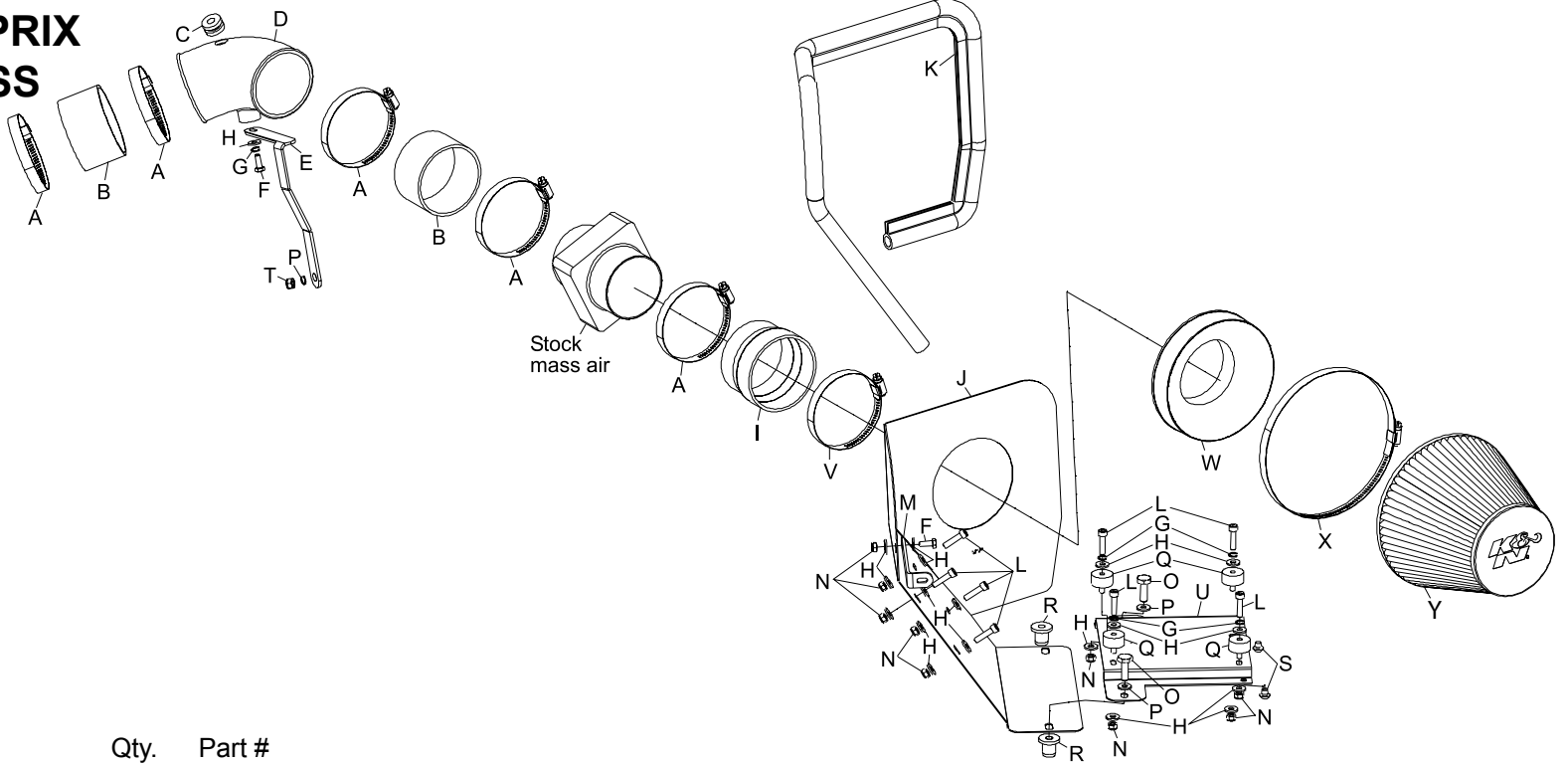

TOOLS NEEDED:

- 1/2" socket
- 5mm allen wrench
- 10mm socket
- 13mm socket
- 10mm wrench
- 27 torx socket
- extension
- flat blade screwdriver
- ratchet

PARTS LIST:

Description	Qty.	Part #	Description	Qty.	Part #	Description	Qty.	Part #
A Hose Clamp #52	5	08610	J Heat Shield	1	07674	S Rubber Plug; 1/4"	2	08162
B Silicone Hose	2	08690	K Edge Trim 44"	1	102486	T Nut; 8mm Nylock	1	07542
C Grommet; 15/16"OD, 3/8"ID, 17/32"THK	1	08100	L Bolt; 6mm-1.00 X 25mm Allen	8	07859	U Processor Bracket	1	26628-1
D Intake Tube (FV)	1	087194	M Bracket; Small "L"	1	070952	V Hose Clamp #56	1	08620
E Bracket; Large "L"	1	26627	N Nut; 6mm Nylock	9	07553	W Filter Adapter	1	21512
F Bolt; m6-1.00 X 16mm Hex HD	2	07703	O Bolt; 5/16"- 18 x 1"L,SS	2	07777	X Hose Clamp # 104	1	08697
G Washer; 1/4" Split Lock	5	08198	P Washer; 5/8"OD x 5/16"ID	3	08276	Y Air Filter	1	RF-1048
H Washer; 5/8"OD x 1/4"ID	19	08275	Q Rubber Stud, m/f, 1/2"LX 1"W, M6 X 1.00	4	070228			
I Silicone Step Hose	1	08051	R Insert Nut; 5/16-18x.600odx.730L Rubber	2	088002			

NOTE: FAILURE TO FOLLOW INSTALLATION INSTRUCTIONS AND NOT USING THE PROVIDED HARDWARE MAY DAMAGE THE INTAKE TUBE, THROTTLE BODY AND ENGINE.

TO START:

1. Turn off the ignition and disconnect the negative battery cable.

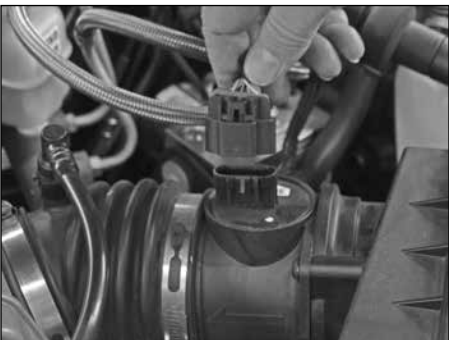

2. Depress the locking tab on the mass air sensor electrical connection, then disconnect the mass air sensor electrical connection as shown.



3. Release the locking tab and disconnect the crank case vent tube as shown.



4. Loosen the hose clamp, which secures the intake tube to the throttle body, and release the air box over center clips shown.

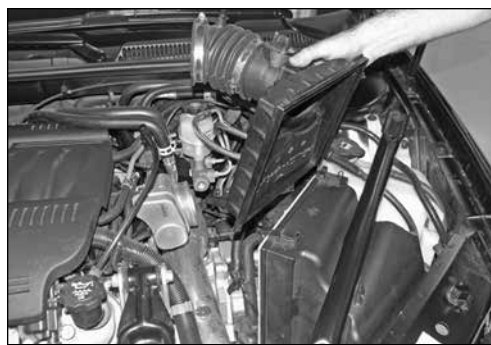

5. Remove the air box housing half and intake tube as shown.



6. Remove the three body support brace mounting bolts shown and then remove the support brace from the engine compartment.

NOTE: It will be necessary to unhook the cruise control and wiring harness clips from the body brace.

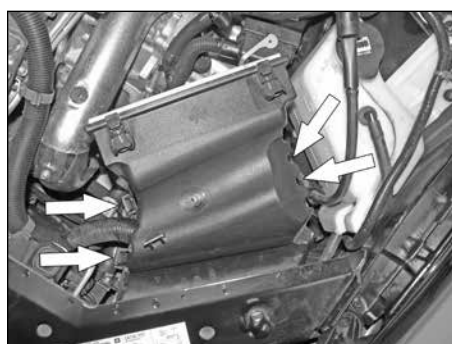

7. Depress the four air box housing retaining clips shown.



8. Remove the upper air box housing from the vehicle as shown.



9. Remove the transmission control module from the housing, release the clamshell retaining clip, and then disconnect the wiring harness as shown.

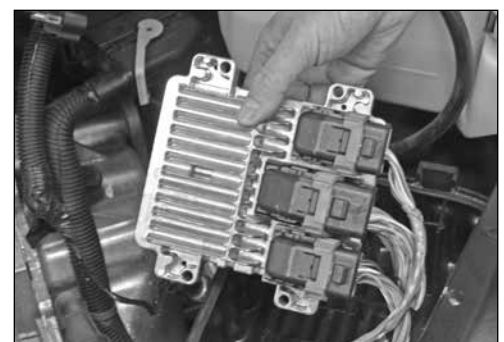

10. Release the engine control module from the mounting clip and lift the module from the base as shown.



11. Release the engine control module wiring harness clamshell clips and disconnect the wiring harness from the engine control module.



12. Pull up the lower air box housing to release it from the mounting grommets and then remove the housing from the vehicle as shown.

NOTE: K&N Engineering, Inc., recommends that customers do not discard factory air intake.

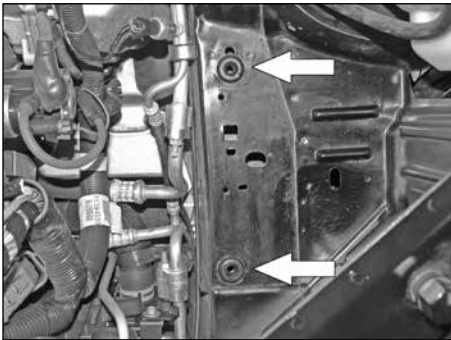

13. Remove the two mounting grommets shown from the inner fender.

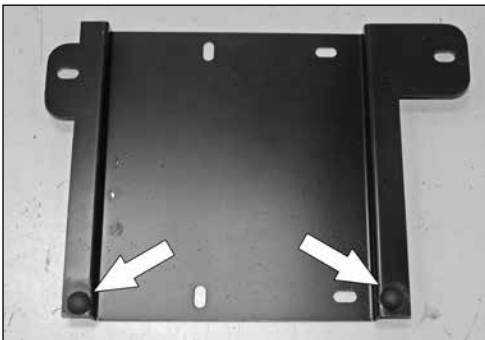

14. Install the rubber bumpers provided into the engine control module-mounting bracket (26628-1) as shown.

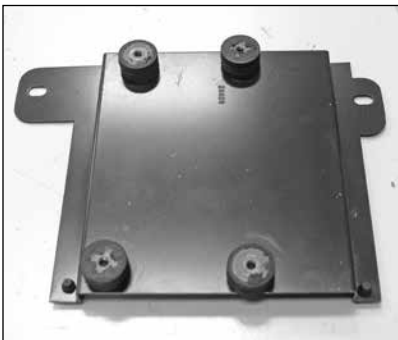

15. Install the four rubber mounted studs onto the engine control module mounting bracket as shown using the provided hardware.

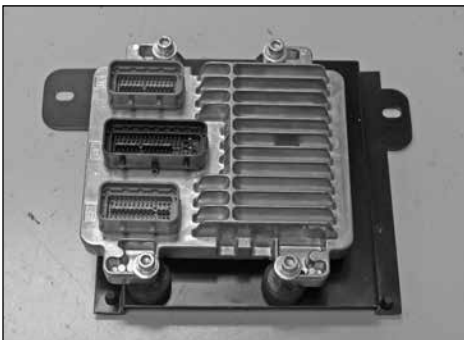

16. Install the engine control module onto the mounting bracket as shown with the provided hardware.

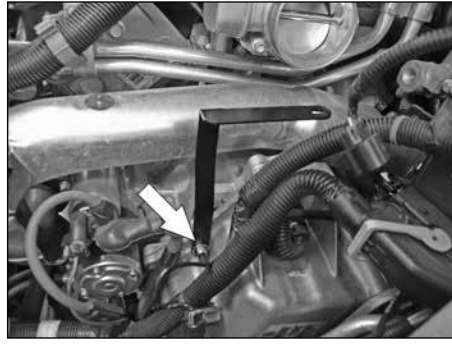

17. Install the tube mounting bracket (26627) onto the existing transmission stud as shown.

NOTE: It will be necessary to remove the wiring harness retaining clip from the stud.

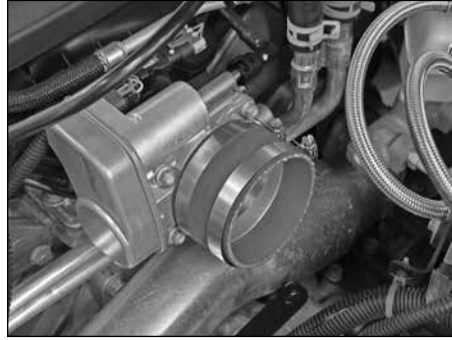

18. Install the silicone hose (08690) onto the throttle body and secure with the provided hose clamp.



19. Install the provided grommet into the K&N® intake tube as shown.

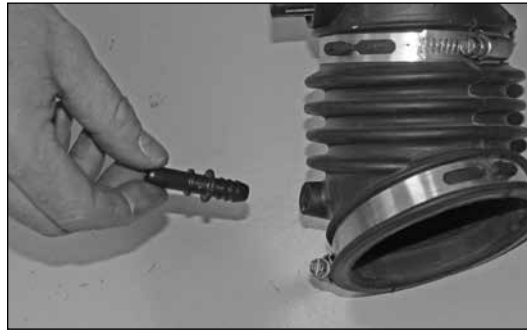

20. Remove the crank case vent fitting from the stock intake tube as shown.

NOTE: This fitting will be reused.

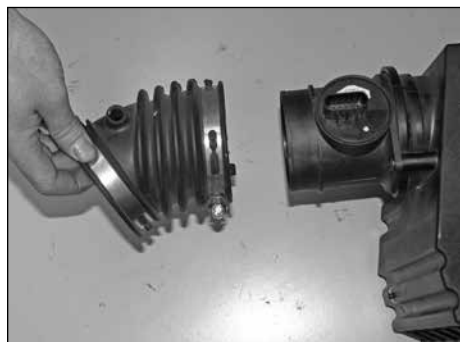

21. Loosen the hose clamp, which secures the stock intake tube to the mass air sensor, and then remove the hose from the sensor as shown.

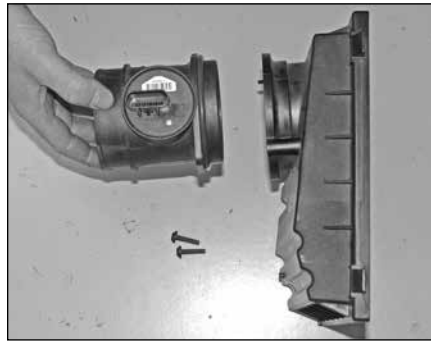

22. Remove the two screws, which secure the mass air sensor to the air filter housing and then remove the mass air sensor as shown.

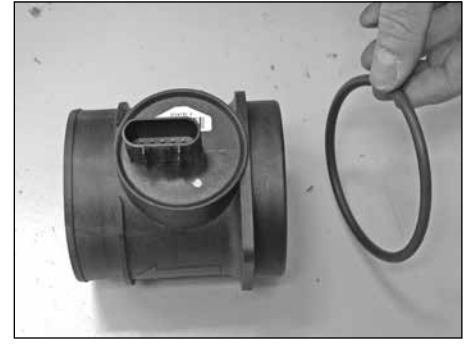

23. Remove the "O" ring from the mass air sensor as shown.

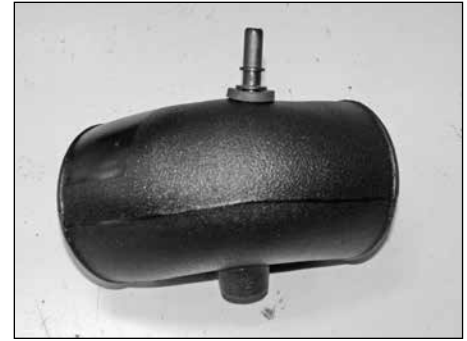

24. Install the factory crank case vent fitting removed in step #20 into the grommet installed into the K&N® intake tube in step #19.

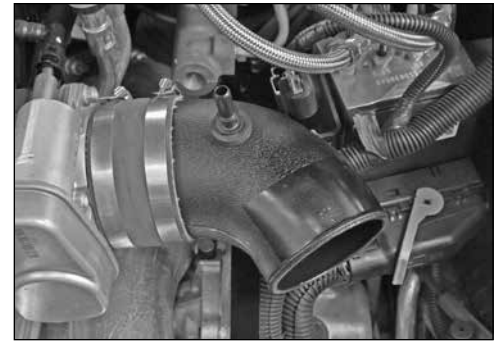

25. Install the K&N® intake tube into the silicone hose at the throttle body and align with the mounting bracket installed in step #17. Secure the silicone hose onto the throttle body with the supplied hardware and hose clamp.

NOTE: Do not completely tighten at this time.

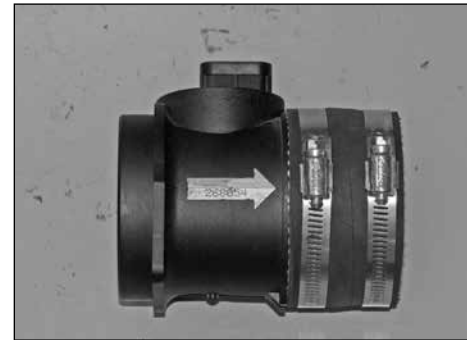

26. Install the silicone hose (08690) onto the mass air sensor as shown and secure with the provided hose clamps.

NOTE: Install the hose so that the arrow molded on the side of the mass air sensor points towards the hose as shown.



27. Install the mass air sensor assembly onto the K&N® intake tube as shown and secure with the provided hose clamp.

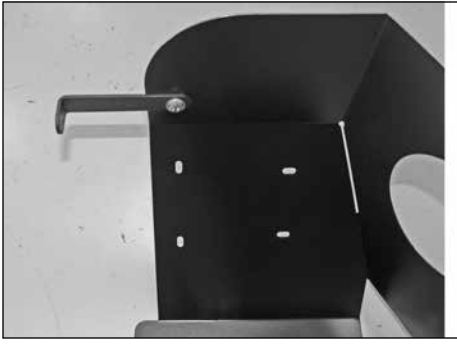

28. Install the mounting bracket (070952) onto the heat shield with the provided hardware.

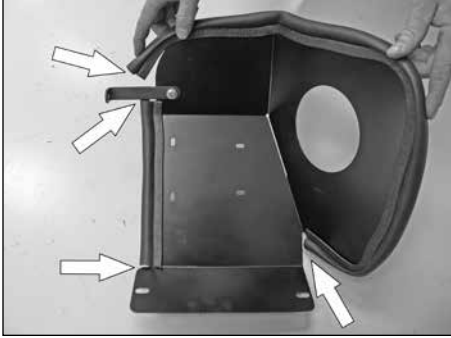

29. Install the provided edge trim onto the heat shield as shown.

NOTE: It will be necessary to cut the edge trim to start and stop on both sides of the mounting bracket as shown.

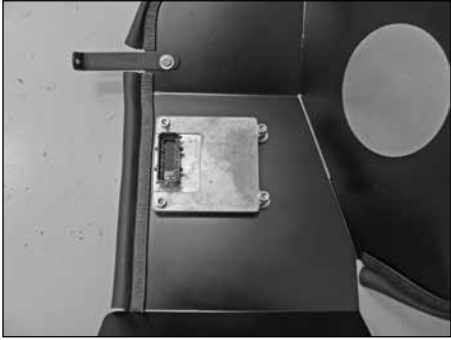

30. Secure the transmission control module to the heat shield with the provided hardware as shown.
NOTE: Four washers should be placed between the heat shield and module to form an air gap.

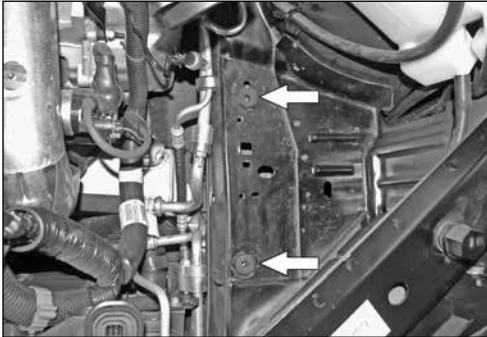

31. Install the two inserted nuts into the air box mounting grommet holes as shown.



32. Remove the top left radiator mounting bracket bolt shown.

NOTE: Be sure to route the wiring harness below the heat shield mounting bracket.

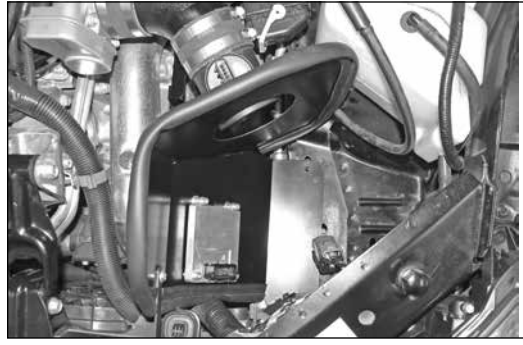

33. Install the heat shield assembly onto the inner fender and secure the mounting bracket to the radiator mount using the factory bolt removed in step #32.

NOTE: Be sure to route the wiring harness below the heat shield mounting bracket.



34. Place the engine control module assembly into position on top of the heat shield, then secure the heat shield and control module bracket to the inserted nuts installed in step #31 with the provided hardware.

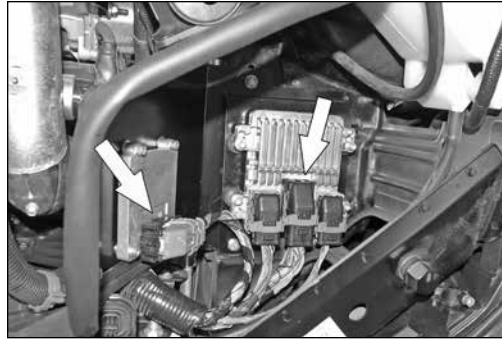

35. Reconnect the engine control module and transmission control module electrical connections.



36. Install the filter adapter into the K&N® air filter as shown and secure with the provided hardware.



37. Install the silicone hose (08051) onto the K&N® filter assembly as shown and secure with the provided hose clamp.



38. Install the air filter assembly onto the mass air sensor and secure with the provided hose clamp.



39. Reinstall the body brace removed in step #6 and secure with the factory bolts.



40. Reconnect the crank case vent tube to the vent fitting as shown.



41. Reconnect the mass air sensor electrical connection.



42. Reconnect the vehicle's negative battery cable. Double check to make sure everything is tight and properly positioned before starting the vehicle.

43. It will be necessary for all K&N® high flow intake systems to be checked periodically for realignment, clearance and tightening of all connections. Failure to follow the above instructions or proper maintenance may void warranty.

ROAD TESTING:

1. Start the engine with the transmission in neutral or park, and the parking brake engaged. Listen for air leaks or odd noises. For air leaks secure hoses and connections. For odd noises, find cause and repair before proceeding. This kit will function identically to the factory system except for being louder and much more responsive.

2. Test drive the vehicle. Listen for odd noises or rattles and fix as necessary.

3. If road test is fine, you can now enjoy the added power and performance from your kit.

4. K&N Engineering, Inc., suggests checking the air filter element periodically for excessive dirt build-up. When the element becomes covered in dirt (or once a year), service it according to the instructions on the Recharger® service kit, part number 99-5050 or 99-5000.