



AIRCHARGER

HIGH-FLOW INTAKE KITS

INSTALLATION INSTRUCTIONS

63-2587

FORD

2014-15 Fiesta ST

L4-1.6 Turbo

TOOLS NEEDED:

- flat blade screw driver
- ratchet
- extension
- 10mm socket
- 4mm allen key
- 3mm allen key
- t25 torx

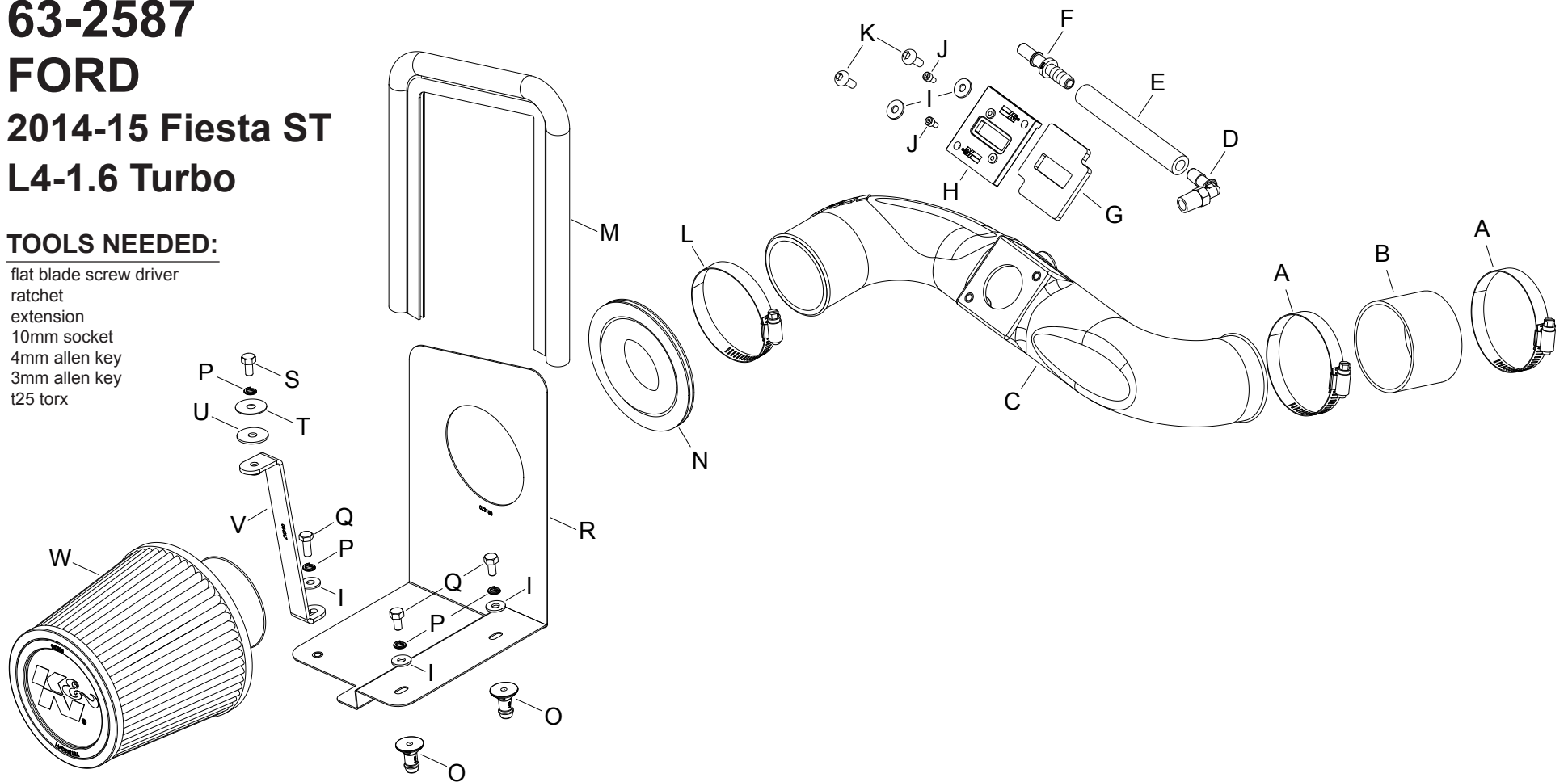

PARTS LIST:

Description	Qty.	Part #	Description	Qty.	Part #	Description	Qty.	Part #			
A	Hose Clamp #44 Stainless	2	08560	I	Washer; 6MM Flat, SS	5	08269	Q	Bolt; M6 X 1.00 X 12MM, SS	3	07727
B	Hose; 2-3/4" ID X 2"L Reinforced	1	08440	J	Bolt; M4-0.07 8MM, A/H Cap, SS	2	07733	R	Heat Shield	1	073158
C	Intake Tube	1	087270	K	Bolt; M6 X 1.00 X 16MM	2	07730	S	Bolt; 6MM-1.00 X 16MM, SS	1	07812
D	Vent; 1/4 NPT, 90 DEG., 3/8"	1	08523	L	HOSE CLAMP #44	1	08577	T	Washer; 1"D X 1/4 Hole Fender	1	08160
E	Hose; 3/8"ID X 5"L	1	5-1005	M	Edge Trim; 3/4" Bulb, Side Loc	1	102477	U	Washer; 1" X .300 X .100 Rubber	1	21685
F	Vent; STRT, 3/8" Barb to quick	1	82631	N	Edge Trim (26")	1	102488	V	Bracket; "L", 63-2587, STL	1	064317
G	Gasket; 57-2556, 3/16 Poron	1	09069	O	Mount Plastic Airbox	2	8-186	W	Air Filter	1	RU-4960
H	Adaptor; #420, Nylon 6/6 GF	1	21515	P	Washer, M6 Split Lock Zinc	4	1-3025				

NOTE: FAILURE TO FOLLOW INSTALLATION INSTRUCTIONS AND NOT USING THE PROVIDED HARDWARE MAY DAMAGE THE INTAKE TUBE, THROTTLE BODY AND ENGINE.

TO START:

1. Turn off the ignition and disconnect the negative battery cable.

NOTE: Disconnecting the negative battery cable erases pre-programmed electronic memories. Write down all memory settings before disconnecting the negative battery cable. Some radios will require an anti-theft code to be entered after the battery is reconnected. The anti-theft code is typically supplied with your owner's manual. In the event your vehicles anti-theft code cannot be recovered, contact an authorized dealership to obtain your vehicles anti-theft code.

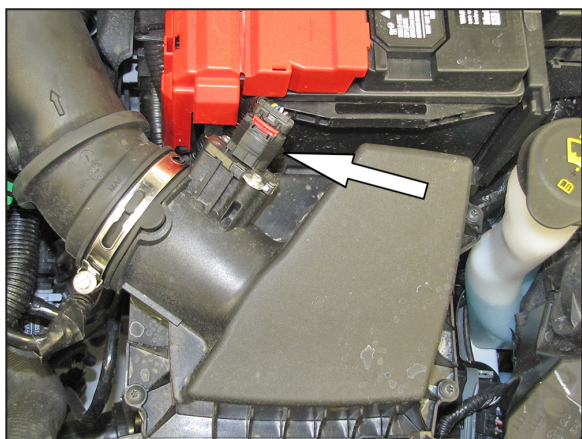

2. Release the red locking tab and then disconnect the Mass air sensor electrical connection.



3. Lift off the decorative engine cover.



4. Release the green locking tab and then disconnect the EVAP vent line from the factory intake tube.

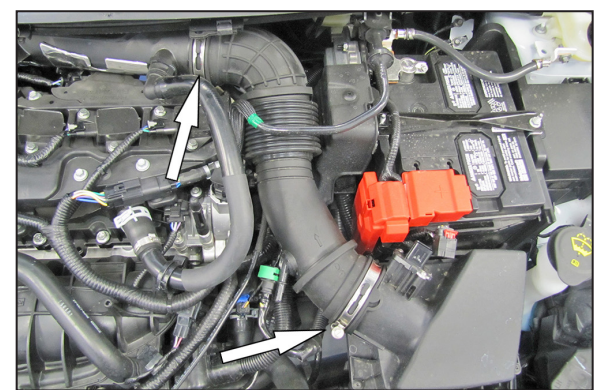

5. Loosen the hose clamps securing the factory intake tube to the turbo inlet pipe and to the factory air filter housing. Remove the factory intake tube from the vehicle.



6. Using a flat blade screw driver, gently pry up the fresh air scoop to release it from the locking tab. Then push it towards the rear of the vehicle to release it from the Fresh air intake.



7. Remove the complete air box assembly from the vehicle by pulling up to release it from the grommets.

NOTE: K&N Engineering, Inc., recommends that customers do not discard factory air intake.

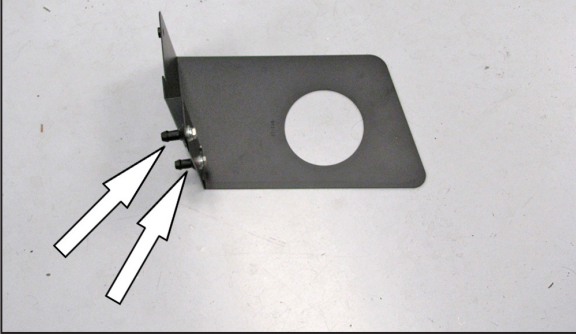

8. Install the two provided heat shield mounts onto the heat shield as shown using the provided hardware.

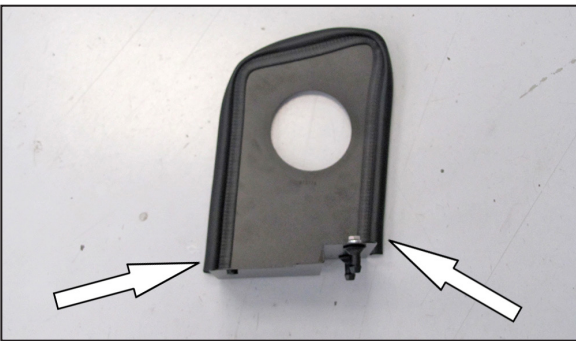

9. Install the provided "Top Bulb" edge trim around the outside of the heat shield as shown.

NOTE: Some trimming of the edge trim will be necessary.

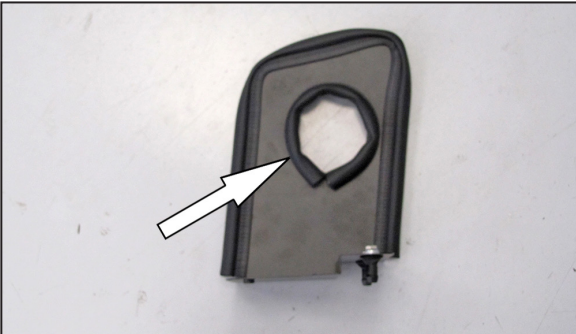

10. Install the provided "Side Bulb" edge trim around the inside of the hole in the heat shield as shown.

NOTE: Some trimming of the edge trim will be necessary. The Bulb side is to be on the filter side of the heat shield.

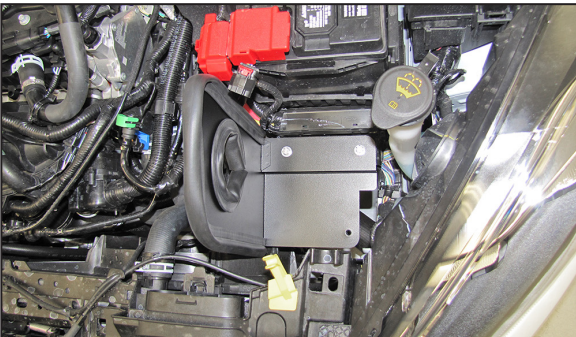

11. Install the heat shield into the vehicle so that the two mounting posts engage the air box mounting grommets.

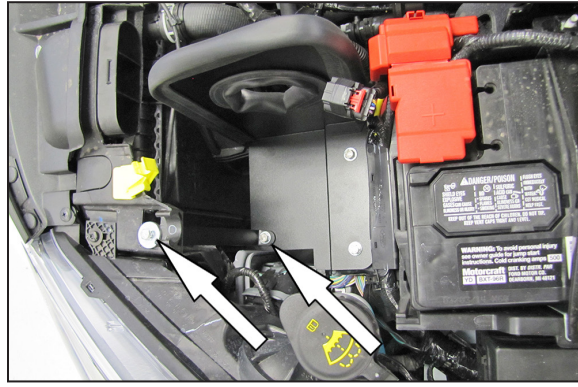

12. Secure the heat shield mounting bracket (064317) to the heat shield and core support as shown using the provided hardware.



13. Remove the fresh air intake duct from the factory air box by pulling it away.

NOTE: The duct is secured into the air box with two tabs and will require some effort to separate. Caution should be used to prevent damage while separating.

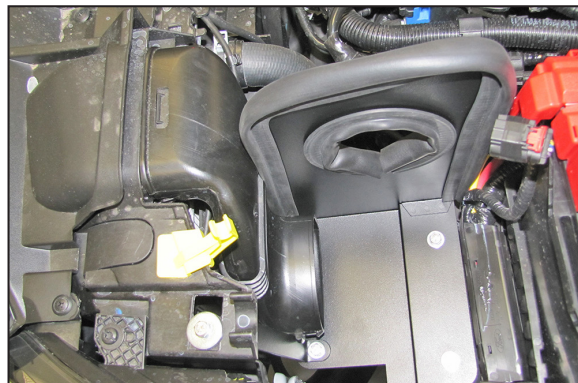

14. Reinstall the fresh air intake duct onto the core support duct as shown.

NOTE: The open end of the fresh air duct will rest on the heat shield under the K&N® air filter once it is installed.

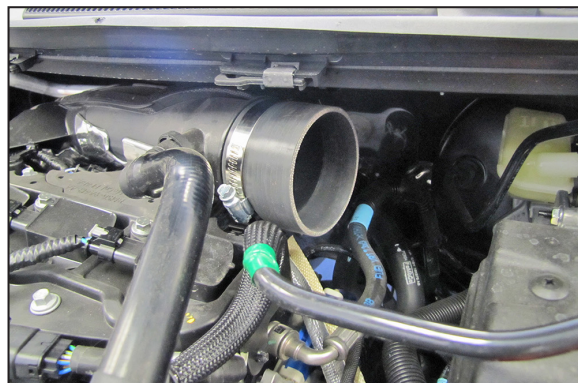

15. Install the provided coupling hose (08440) onto the turbo inlet pipe and secure with the provided hose clamp.

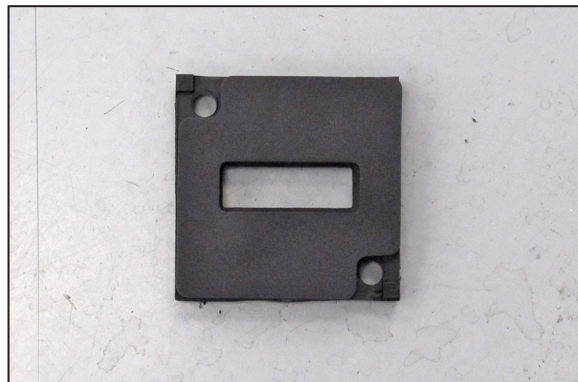

16. Install the provided gasket onto the K&N® mass air sensor adapter.

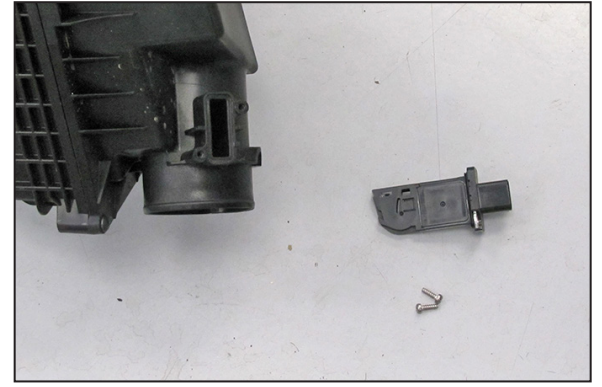

17. Remove the mass air sensor from the factory air box.



18. Install the mass air sensor into the K&N® adapter and secure with the provided hardware.

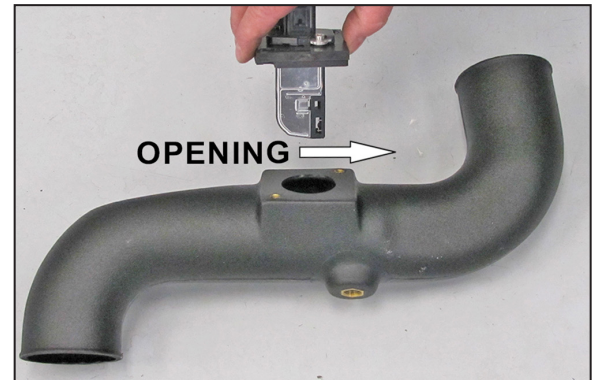

19. Install the mass air sensor assembly into the K&N intake tube and secure with the provided hardware.

NOTE: The opening in the Mass air sensor should be pointed towards the filter end of the tube.

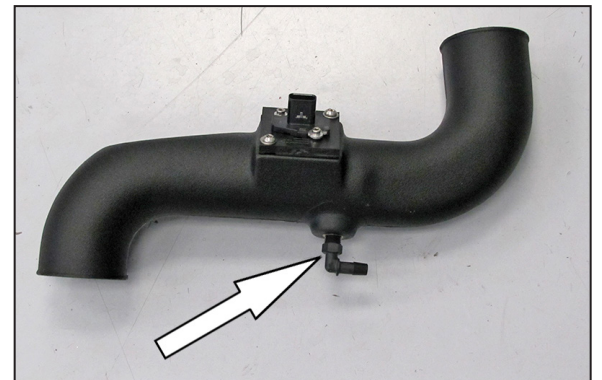

20. Install the 90° vent fitting into the K&N® intake tube as shown.
NOTE: Plastic NPT fittings are easy to cross thread. Install the vent fitting "hand" tight, then turn it two complete turns with a wrench.

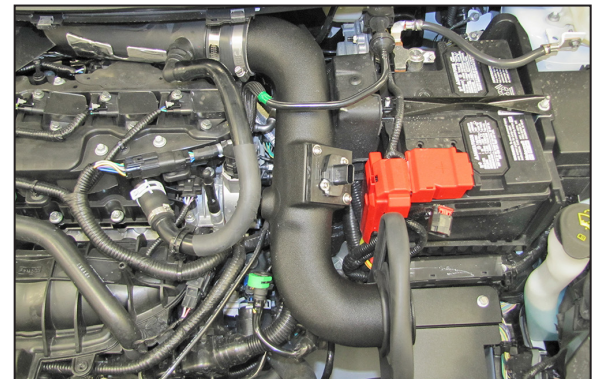

21. Install the K&N® intake tube assembly into the silicone hose at the turbo inlet pipe and then into the heat shield, adjust the tube for proper fit and then secure with the provided hose clamps.

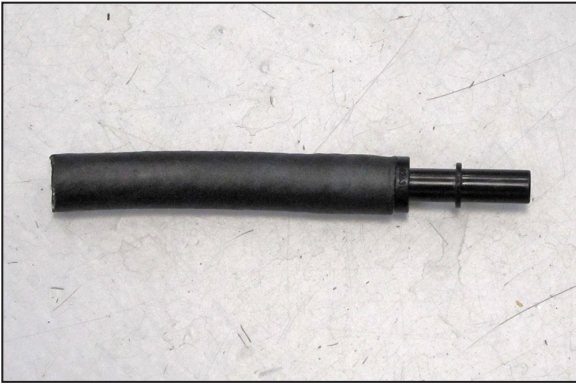

22. Install the provided EVAP vent hose onto the provided quick disconnect union as shown.

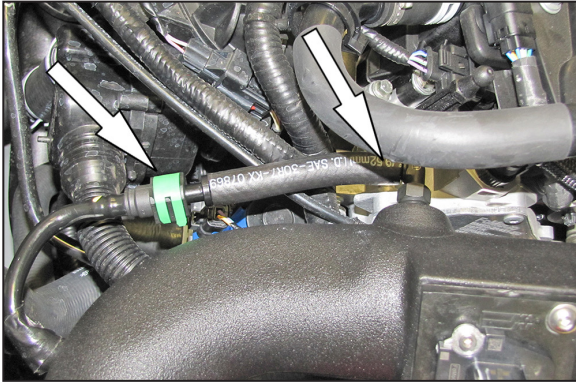

23. Install the EVAP hose assembly into the factory quick disconnect fitting and then onto the 90° fitting installed into the K&N® intake tube as shown.

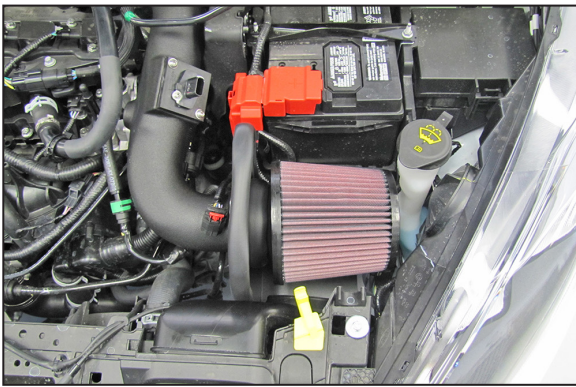

24. Install the K&N® air filter onto the intake tube and secure with the provided hose clamp.
NOTE: Drycharger® air filter wrap; part # RX-4990DK is available to purchase separately.

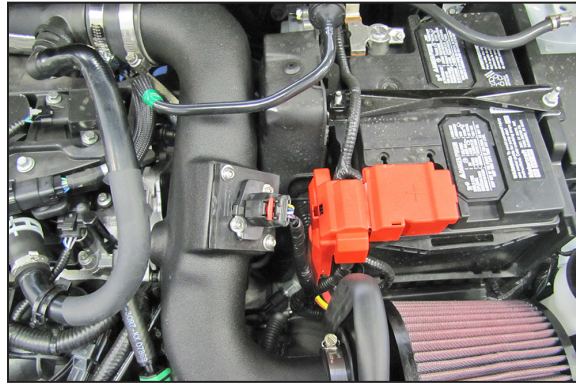

25. Connect the mass air sensor electrical connection as shown.

NOTE: It may be necessary to cut the tape securing the mass air sensor pigtail to allow enough length for it to connect.



26. Reinstall the decorative engine cover.

27. Reconnect the vehicle's negative battery cable. Double check to make sure everything is tight and properly positioned before starting the vehicle.

28. It will be necessary for all K&N® high flow intake systems to be checked periodically for realignment, clearance and tightening of all connections. Failure to follow the above instructions or proper maintenance may void warranty.

ROAD TESTING:

1. Start the engine with the transmission in neutral or park, and the parking brake engaged. Listen for air leaks or odd noises. For air leaks secure hoses and connections. For odd noises, find cause and repair before proceeding. This kit will function identically to the factory system except for being louder and much more responsive.

2. Test drive the vehicle. Listen for odd noises or rattles and fix as necessary.

3. If road test is fine, you can now enjoy the added power and performance from your kit.

4. K&N Engineering, Inc., requires cleaning the intake system's air filter element every 100,000 miles. When used in dusty or off-road environments, our filters will require cleaning more often. We recommend that you visually inspect your filter once every 25,000 miles to determine if the screen is still visible. When the screen is no longer visible some place on the filter element, it is time to clean it. To clean and re-oil, purchase our filter Recharger® service kit, part number 99-5050 or 99-5000 and follow the easy instructions.