



AIRCHARGER

HIGH-FLOW INTAKE KITS

INSTALLATION INSTRUCTIONS

63-1563

DODGE / JEEP

2011-14 Durango

V8-5.7L

2011-14 Cherokee

V8-5.7L

NOTE: This kit was not designed to fit vehicles with a body lift.

TOOLS NEEDED:

- 4mm Allen Wrench
- 10mm Socket
- Extension
- Ratchet
- 8mm socket
- 9/16" wrench
- Pliers

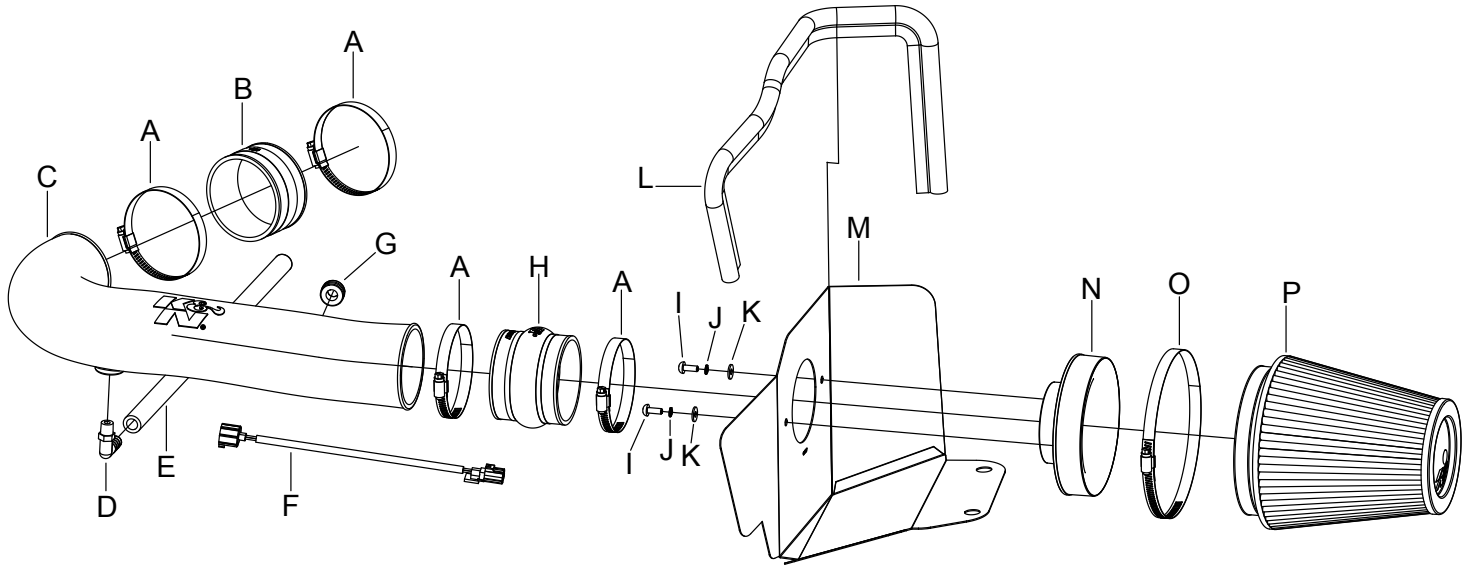

PARTS LIST:

Description	Qty.	Part #	Description	Qty.	Part #
A Hose Clamp # 56	4	08620	I Bolt; M6 X 1.00 X 16MM, Buttonhead, SS	2	07730
B Hose; 3-1/2" ID X 2" L Molded	1	08630	J Washer, M6 Split Lock Zinc	2	08269
C Intake Tube (IH)	1	087249	K Washer, 6MM Flat, SS	2	1-3025
D 90 DEG, 1/2" Hose, 1/4" NPT, Blk.	1	08110FK	L Edge Trim (30")	1	102489
E Hose; 1/2" ID X 19" L	1	084075	M Heat Shield	1	074087
F Extension Harness; Dodge IAT	1	21680	N Adapter; Universal, 6" Filter 3.5" Coupler	1	21512-1
G Grommet; 1" OD, 1/2" ID, 1/2" THK	1	08064	O Hose Clamp # 104	1	08697
H Hose; 3-1/2" ID X 3" L Hump Molded	1	084057	P Air Filter	1	RF-1041

NOTE: FAILURE TO FOLLOW INSTALLATION INSTRUCTIONS AND NOT USING THE PROVIDED HARDWARE MAY DAMAGE THE INTAKE TUBE, THROTTLE BODY AND ENGINE.

TO START:

1. Turn off the ignition and disconnect the negative battery cable.

NOTE: Disconnecting the negative battery cable erases pre-programmed electronic memories. Write down all memory settings before disconnecting the negative battery cable. Some radios will require an anti-theft code to be entered after the battery is reconnected. The anti-theft code is typically supplied with your owner's manual. In the event your vehicles' anti-theft code cannot be recovered, contact an authorized dealership to obtain your vehicles anti-theft code.



2. Lift up the engine cover to dislodge it from the mounting grommets and remove it from the vehicle.

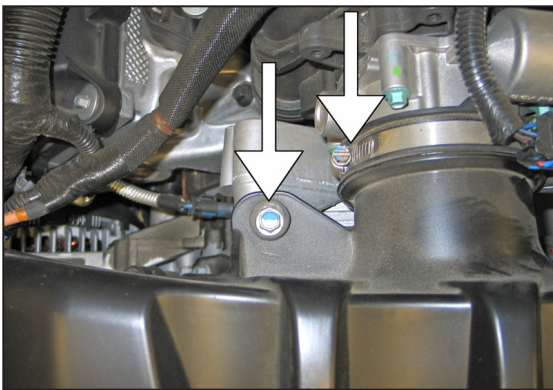

3. Remove the intake plenum mounting bolt shown and loosen the intake tube hose clamp.

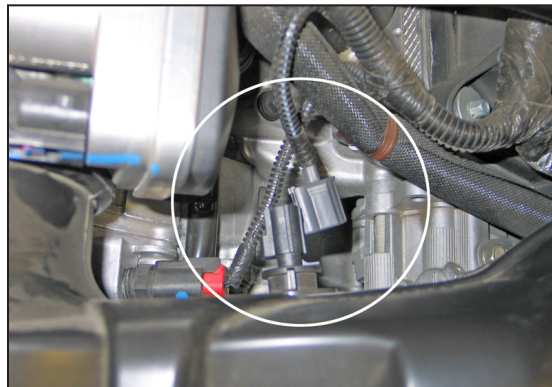

4. Disconnect the inlet air temperature air sensor electrical connection.

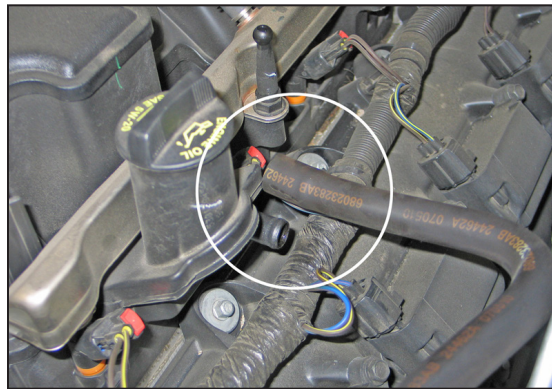

5. Disconnect the crankcase vent hose from the port on the valve cover.

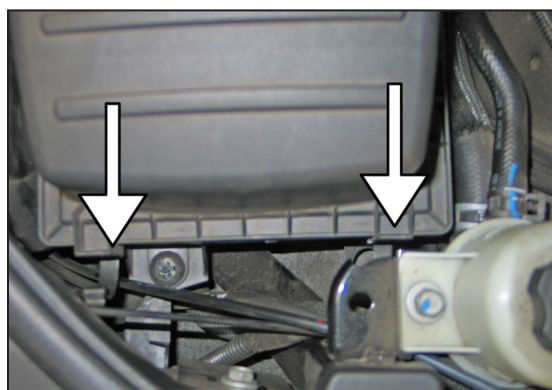

6. Release the two upper airbox retaining clips.



7. Remove the upper airbox and intake tube assembly.

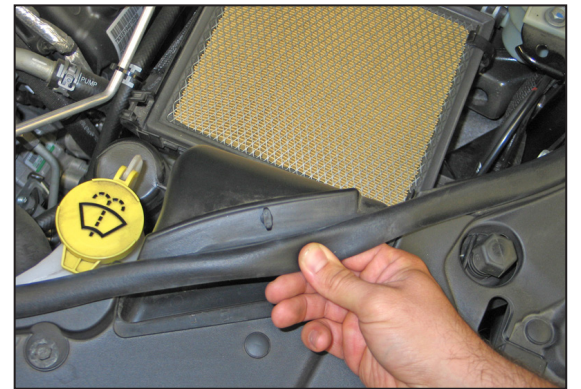

8. Unhook the sealing trim from the fresh air intake scoop.



9. Lift up the lower airbox to dislodge it from the mounting grommets and then remove the lower airbox from the vehicle. Some vehicles may have a power steering line attached to the air box than will need to be unhooked.

NOTE: K&N Engineering, Inc., recommends that customers do not discard factory air intake.

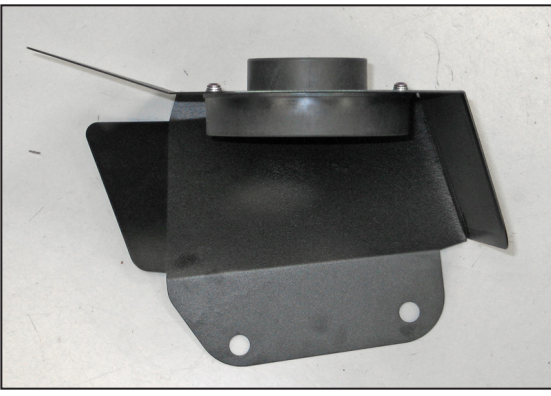

10. Install the filter adapter into the heat shield and secure with the provided hardware.

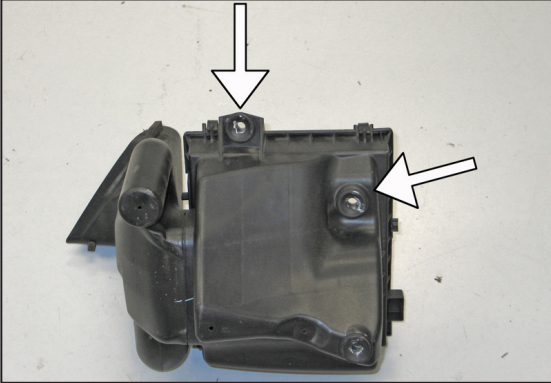

11. Remove two of the factory airbox mounting grommets from the lower airbox.

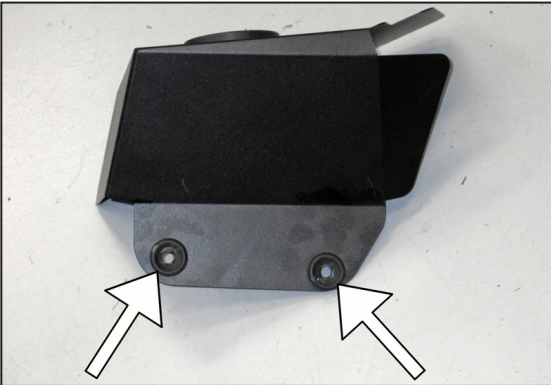

12. Install the two mounting grommets removed in the previous step into the heat shield as shown.

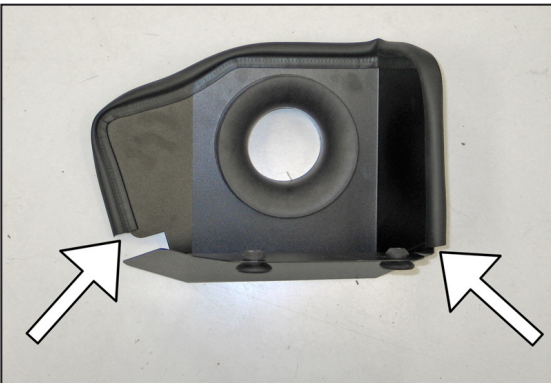

13. Install the provided edge trim onto the heat shield as shown.
NOTE: Some trimming of the edge trim will be necessary.

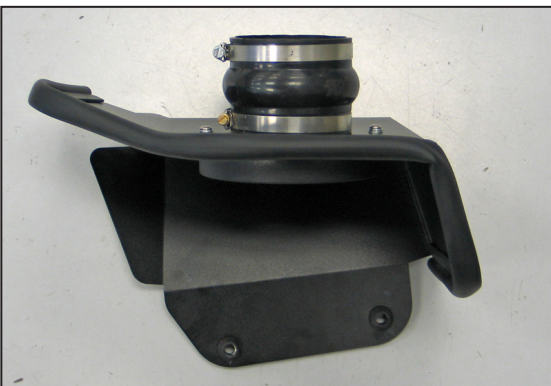

14. Install the provided silicone hump hose (084057) onto the filter adapter and secure with the provided hose clamp.

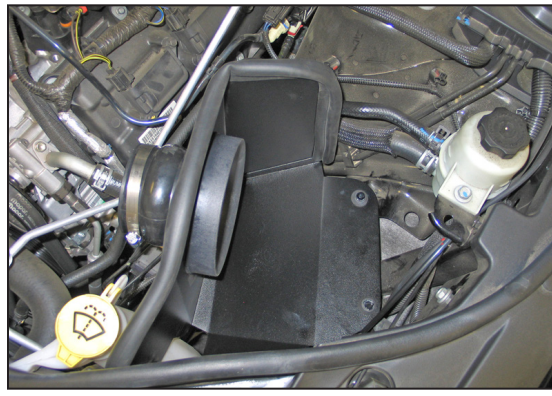

15. Set the heat shield into the vehicle so that the mounting grommets slide over the factory airbox mounting studs.

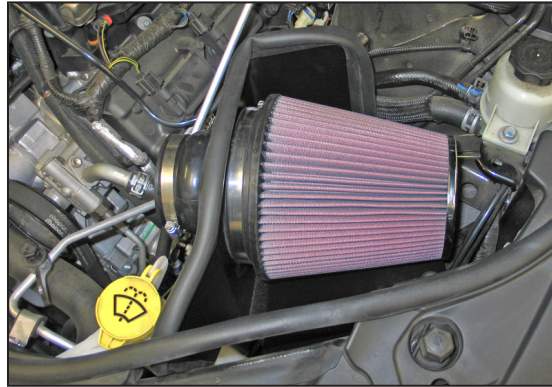

16. Install the K&N® filter onto the adapter and secure with the provided hose clamp.
NOTE: Drycharger® air filter wrap; part # RF-1041DK is available to purchase separately.

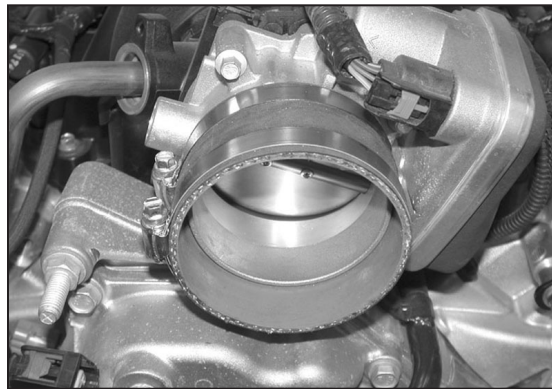

17. Install the provided silicone hose (08630) onto the throttle body and secure with the provided hose clamp.

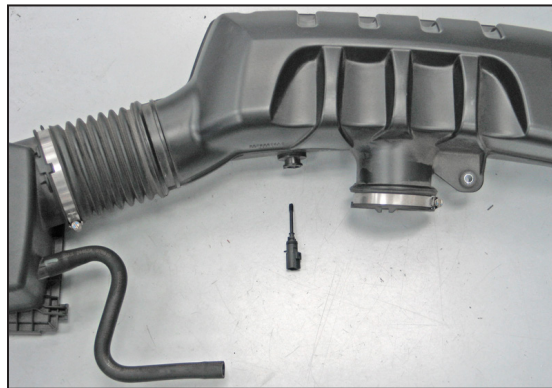

18. Release the locking tab and then remove the inlet air temperature sensor from the factory intake tube by twisting counter clockwise.
NOTE: The inlet air temperature sensor is very fragile; take care to avoid damage while handling the sensor.

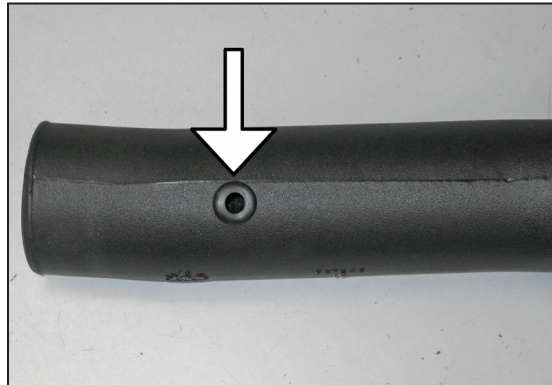

19. Install the provided grommet into the K&N® intake tube as shown.

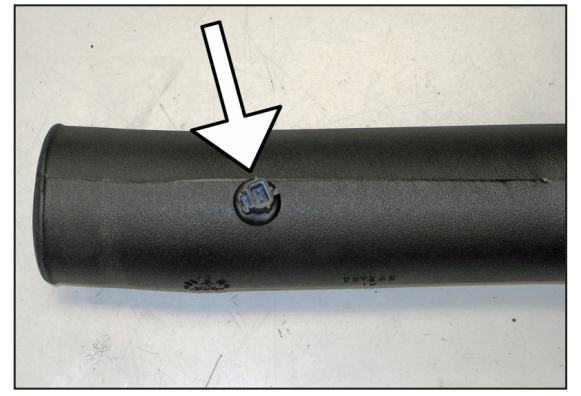

20. Install the inlet air temperature sensor into the K&N® intake tube.

NOTE: Be sure to remove the O-ring from the inlet air temperature sensor before installing.

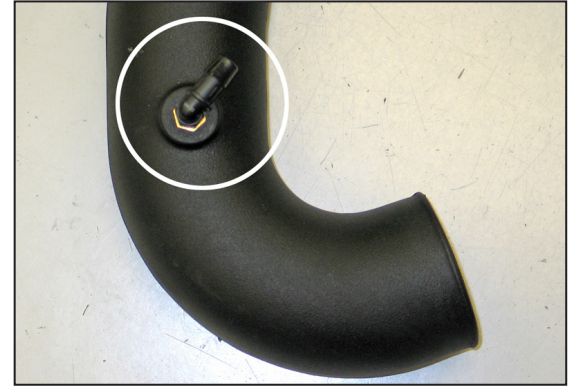

21. Install the 90° npt fitting into the K&N® intake tube as shown.

NOTE: Plastic NPT fittings are easy to cross thread. Install the vent fitting "hand" tight, then turn it two complete turns with a wrench.



21. Install the K&N® intake tube into the hump hose at the filter adapter and then into the hose at the throttle body. Adjust the tube and heat shield for best fit and clearance and then secure with the provided hose clamps

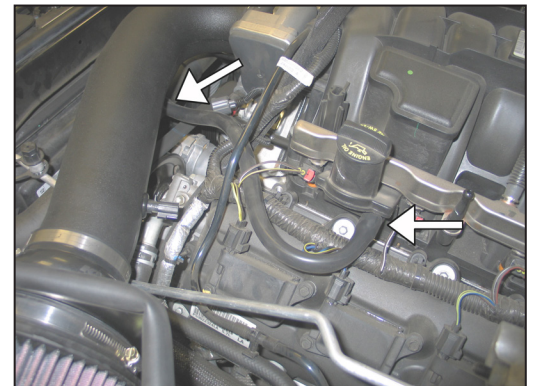

23. Install the crankcase vent hose onto the 90° vent fitting and then attach the open end to the valve cover port.



24. Connect the inlet air temperature sensor extension harness into the factory electrical connection and then connect the other end into the inlet air temperature sensor as shown.



25. Reinstall the engine cover.



26. Reconnect the vehicle's negative battery cable. Double check to make sure everything is tight and properly positioned before starting the vehicle.

27. It will be necessary for all K&N® high flow intake systems to be checked periodically for realignment, clearance and tightening of all connections. Failure to follow the above instructions or proper maintenance may void warranty.

ROAD TESTING:

1. Start the engine with the transmission in neutral or park, and the parking brake engaged. Listen for air leaks or odd noises. For air leaks secure hoses and connections. For odd noises, find cause and repair before proceeding. This kit will function identically to the factory system except for being louder and much more responsive.

2. Test drive the vehicle. Listen for odd noises or rattles and fix as necessary.

3. If road test is fine, you can now enjoy the added power and performance from your kit.

4. K&N Engineering, Inc., requires cleaning the intake system's air filter element every 100,000 miles. When used in dusty or off-road environments, our filters will require cleaning more often. We recommend that you visually inspect your filter once every 25,000 miles to determine if the screen is still visible. When the screen is no longer visible some place on the filter element, it is time to clean it. To clean and re-oil, purchase our filter Recharger® service kit, part number 99-5050 or 99-5000 and follow the easy instructions.