



INSTALLATION INSTRUCTIONS

57-6011
NISSAN
2001-04 Pathfinder
V6 3.5L

NOTE: This kit was not designed to fit vehicles with a body lift.

TOOLS NEEDED:

- Flat Blade Screwdriver
- 10mm Wrench
- 4mm Allen
- Pliers
- Ratchet
- Extension
- 10mm Socket

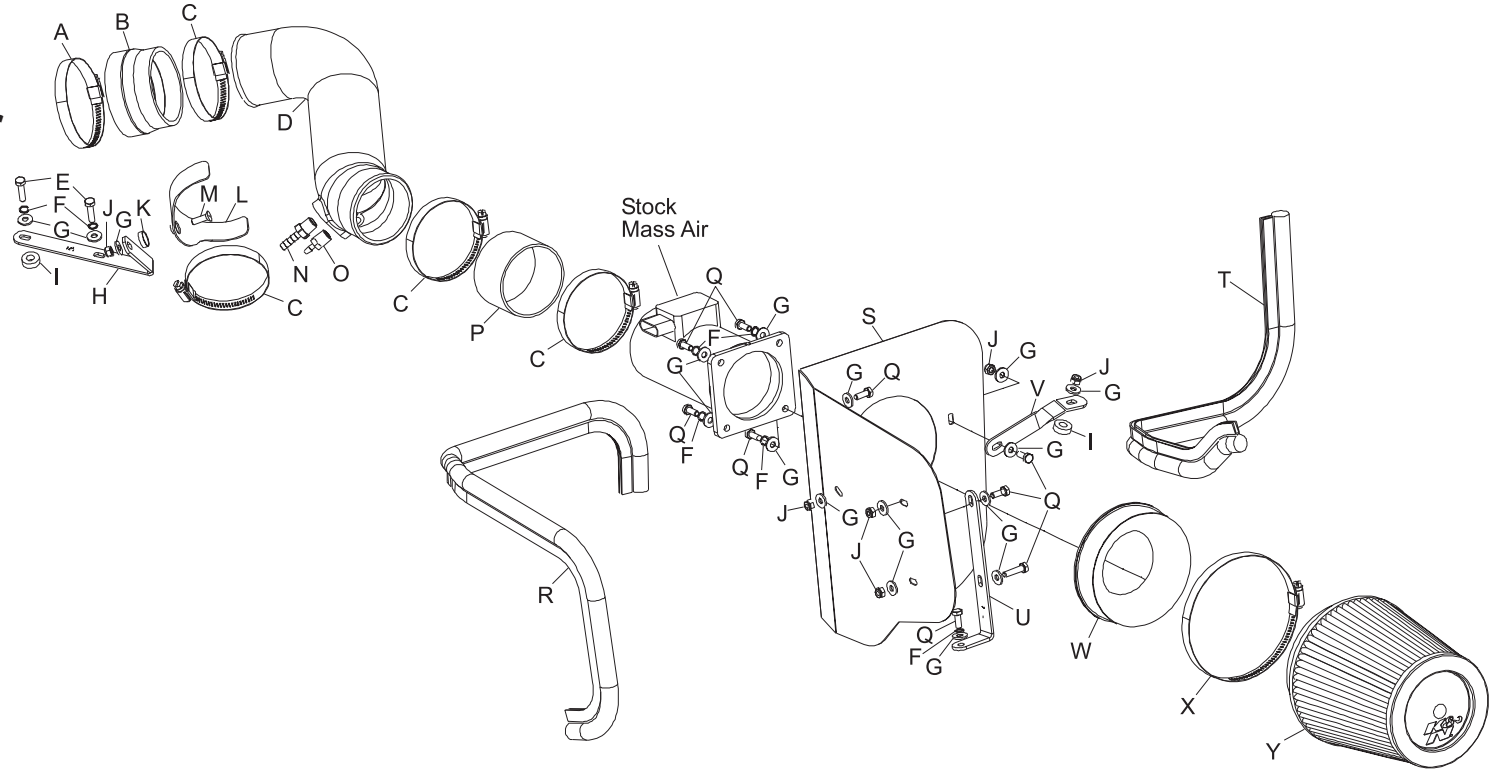

PARTS LIST:

Description	Qty.	Part #	Description	Qty.	Part #	Description	Qty.	Part #
A hose clamp #52	1	08610	J nut; m6 nylock	6	07553	R edge trim 35"L	1	102471
B silicone step hose	1	08186	K cup washer; black nylon	1	08180	S heat shield	1	074017
C hose clamp #48	4	08601	L saddle bracket	1	078855	T edge trim 26"L	1	102488
D intake tube (DL)	1	087107	M bolt; m6-1.00, f/h/a	1	08376	U bracket lg "L"	1	07186
E bolt; m6-1.00x25mm hex	2	07704	N 1/4"npt, 1/4" barb	1	08046	V bracket; twist	1	07945
F washer; 1/4" split, lock	7	08198	O 1/4"npt, 3/16"barb	1	080021	W adapter #410	1	21514
G flat washer 1/4"idx5/8"od	17	08275	P silicone hose	1	08434	X hose clamp #80	1	08694
H bracket "L"	1	070902	Q bolt; m6-1.00 x 16mm hex	9	07703	Y air filter	1	RF-1037
I spacer; 5/8"odx.250"ld	2	06555						

NOTE: FAILURE TO FOLLOW INSTALLATION INSTRUCTIONS AND NOT USING THE PROVIDED HARDWARE MAY DAMAGE THE INTAKE TUBE, THROTTLE BODY AND ENGINE.

TO START:

1. Turn off the ignition and disconnect the negative battery cable.
NOTE: Disconnecting the negative battery cable erases pre-programmed electronic memories. Write down all memory settings before disconnecting the negative battery cable. Some radios will require an anti-theft code to be entered after the battery is reconnected. The anti-theft code is typically supplied with your owner's manual. In the event your vehicles' anti-theft code cannot be recovered, contact an authorized dealership to obtain your vehicles anti-theft code.



2. Disconnect the mass air sensor electrical connection and unhook the mass air sensor harness from the intake tube.

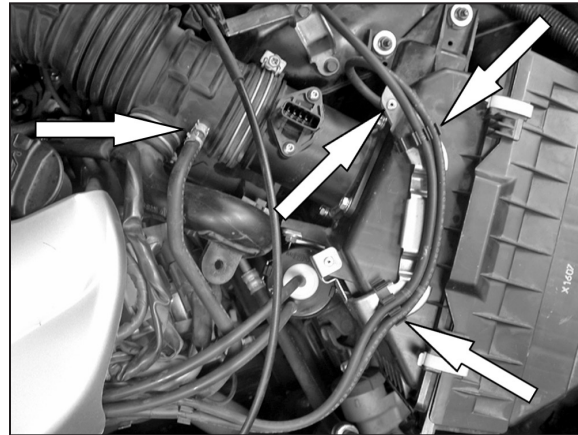

3. Unclip the vacuum lines from the air filter box, then disconnect the vacuum lines from the airbox and intake tube.

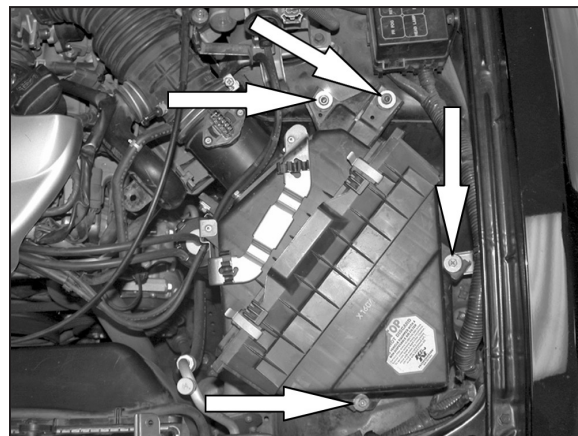

4. Loosen the intake tube hose clamp at the mass air sensor, then remove the two air box mounting nuts and the two air box mounting bolts.

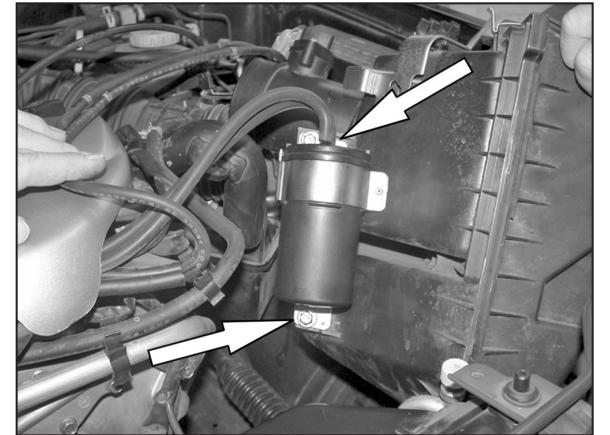

5. On vehicles equipped with SCV vacuum tank, lift the air box and twist to gain access to the SCV vacuum tank retaining bolts and remove, set SCV vacuum tank aside.



6. Remove the airbox assembly from the vehicle.

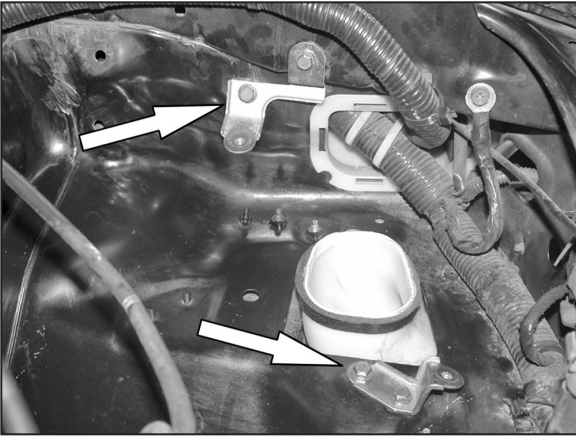

7. Remove the four bolts securing the two air box mounts and remove the mounts.



8. Loosen the spring clamp on the crank case vent hose, then disconnect the crank case vent hose from the intake tube.



9. Loosen the intake tube hose clamp at the throttle body and remove the intake tube mounting bolt shown.



10. Remove the intake tube assembly from the vehicle.

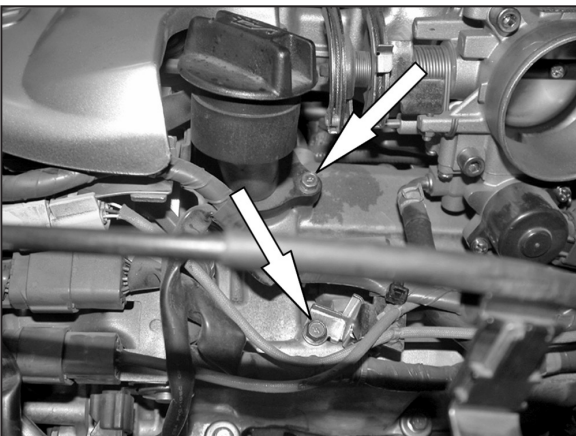

11. Remove the oil fill retaining bolt and the wire harness clip retaining bolts shown.



12. Install the saddle bracket onto the "L" bracket with the provided hardware as shown.



13. Install the saddle bracket assembly onto the valve cover using the hardware provided, threaded into the holes accessed in step #11.

NOTE: Be sure to install the provided spacer between the K&N bracket and valve cover on the out board bolt.



14. Install silicone hose (08186) onto the throttle body with the provided hose clamps.



15. Install the provided NPT fittings onto the K&N® intake tube as shown.

NOTE: Plastic NPT fittings are easy to cross thread. Install the vent fitting "hand" tight, then turn it two complete turns with a wrench.

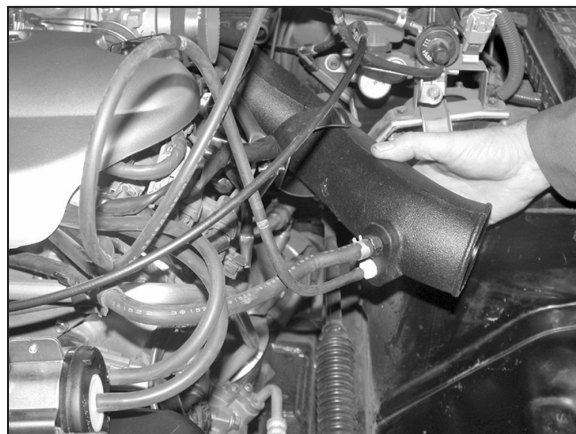

16. Install the vacuum lines removed in step #3 onto the K&N® intake tube as shown.

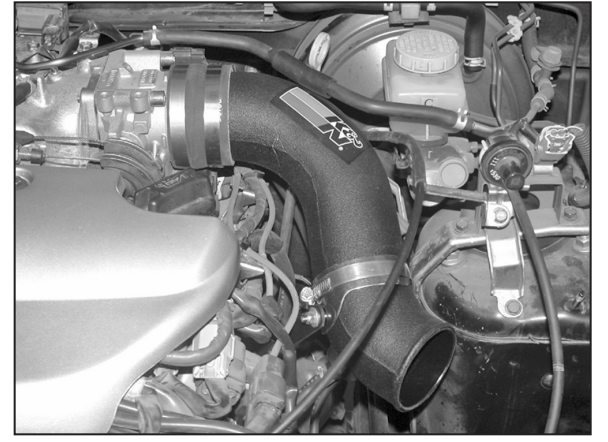

17. Install the K&N® intake tube onto the throttle body and saddle bracket, secure with the provided hose clamps.



18. Install "L" bracket (070902) onto the heatshield with the provided hardware as shown.

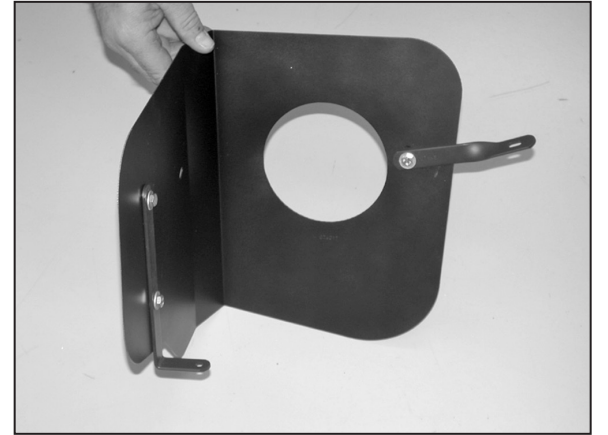

19. Install the twist bracket (07945) onto the heatshield with the provided hardware as shown.



20. Install the edge trim onto the heatshield as shown.

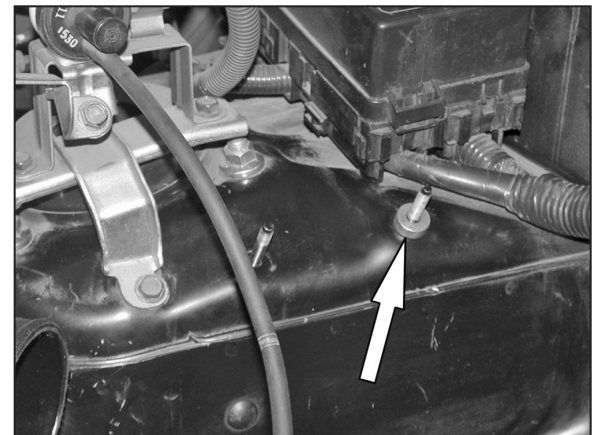

21. Install the provided spacer onto the air box mounting stud as shown.

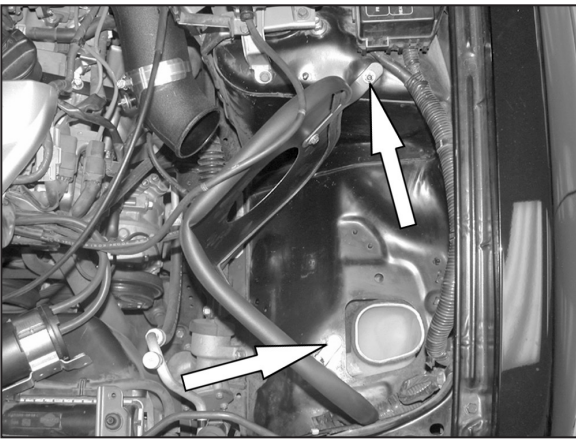

22. Install the K&N® heatshield into the vehicle using the provided hardware.

NOTE: The twist bracket installs onto the airbox mounting stud, the "L" bracket bolts to the airbox mounting bracket location next to the fresh air intake.



22a. On vehicles equipped with the SCV vacuum tank using the hardware provided, bolt the tank to the lower "L" bracket bolt and through the hole in the heatshield as shown.

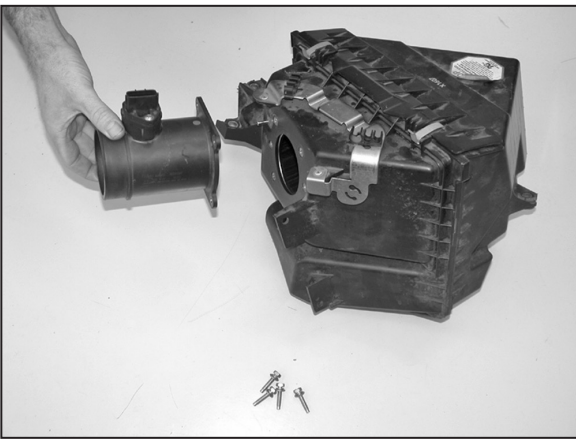

23. Remove the four bolts that secure the mass air sensor to the air box and remove the mass air sensor from the air box.

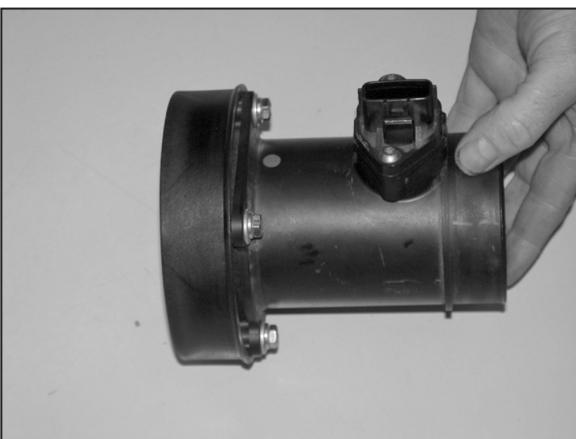

24. Install the K&N® filter adapter into the mass air sensor using the provided hardware.
NOTE: Be sure the O ring seal is in place on the mass air sensor.

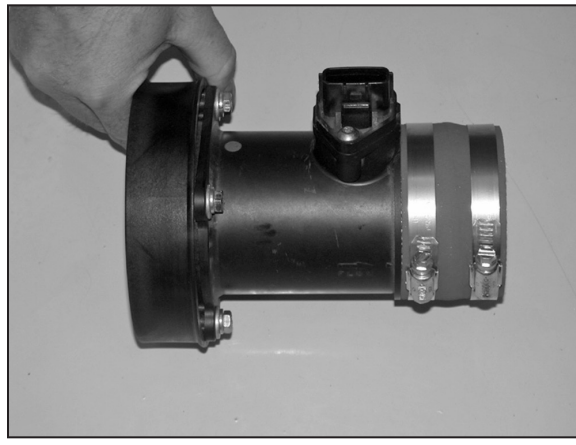

25. Install the silicone hose (08434) onto the mass air sensor with the provided hose clamps as shown.



26. Install the mass air assembly onto the K&N® intake tube and secure with the provided hose clamps as shown.



27. Install the K&N® filter charger onto the mass air adapter and secure with the provided hose clamp.
NOTE: Drycharger® air filter wrap; part # RF-1037DK is available to purchase separately.



28. Install the crank case vent hose to the K&N® intake tube and secure with the existing spring clamp.

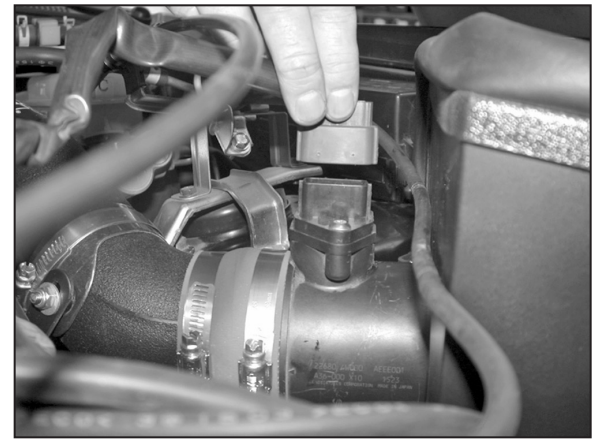

29. Reconnect the mass air sensor electrical connections.



30. Reconnect the vehicle's negative battery cable. Double check to make sure everything is tight and properly positioned before starting the vehicle.

31. The C.A.R.B. exemption sticker, (attached), must be visible under the hood so that an emissions inspector can see it when the vehicle is required to be tested for emissions. California requires testing every two years, other states may vary.

32. It will be necessary for all K&N® high flow intake systems to be checked periodically for realignment, clearance and tightening of all connections. Failure to follow the above instructions or proper maintenance may void warranty.

ROAD TESTING:

1. Start the engine with the transmission in neutral or park, and the parking brake engaged. Listen for air leaks or odd noises. For air leaks secure hoses and connections. For odd noises, find cause and repair before proceeding. This kit will function identically to the factory system except for being louder and much more responsive.

2. Test drive the vehicle. Listen for odd noises or rattles and fix as necessary.

3. If road test is fine, you can now enjoy the added power and performance from your kit.

4. K&N Engineering, Inc., requires cleaning the intake system's air filter element every 100,000 miles. When used in dusty or off-road environments, our filters will require cleaning more often. We recommend that you visually inspect your filter once every 25,000 miles to determine if the screen is still visible. When the screen is no longer visible some place on the filter element, it is time to clean it. To clean and re-oil, purchase our filter Recharger® service kit, part number 99-5050 or 99-5000 and follow the easy instructions.