



INSTALLATION INSTRUCTIONS

57-6010

NISSAN

2001-04 Frontier

2002-04 XTerra

V6-3.3L Supercharged

NOTE: This kit was not designed to fit vehicles with a body lift.

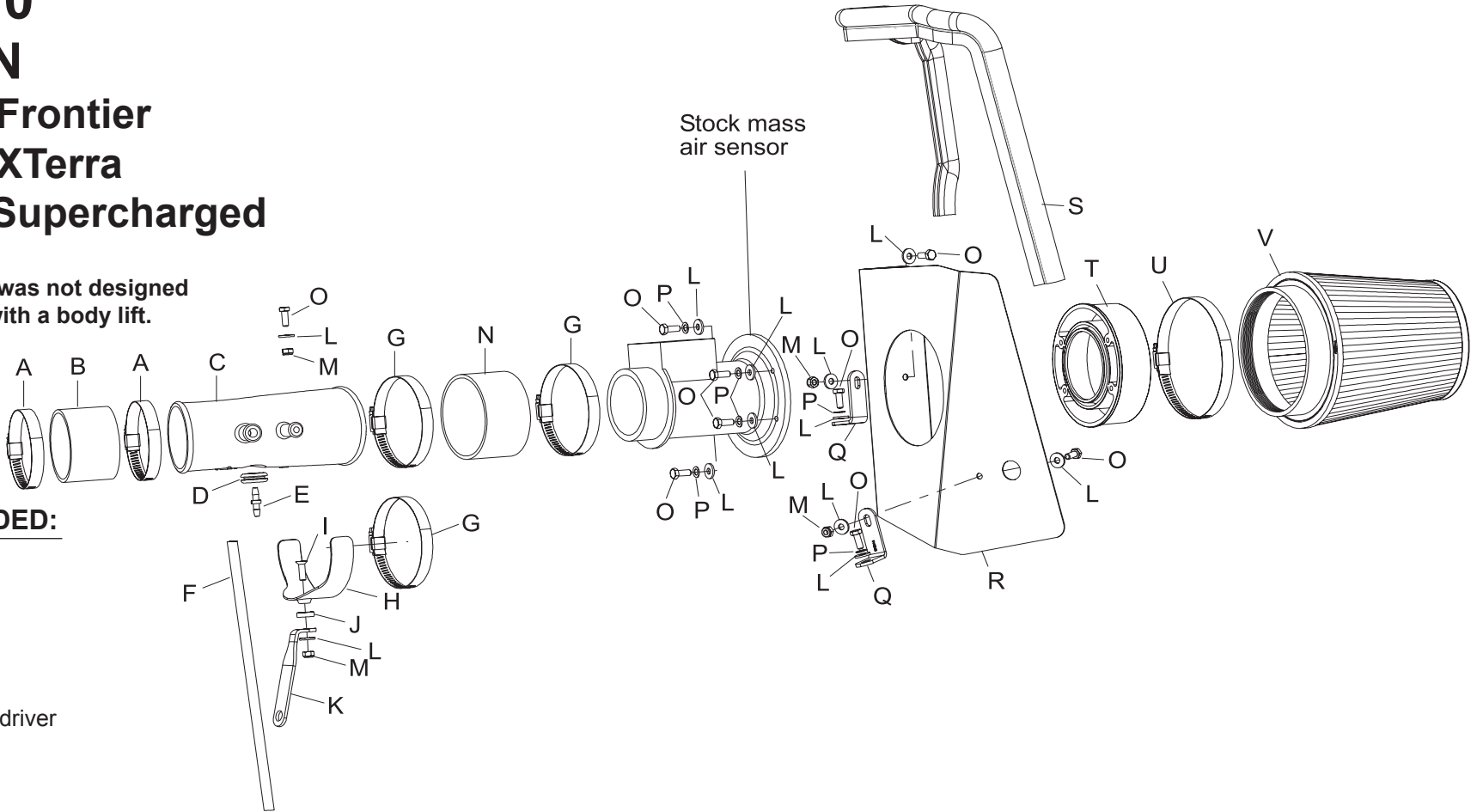

TOOLS NEEDED:

- Ratchet
- 3" extension
- 8mm socket
- 10mm socket
- 10mm wrench
- 14mm wrench
- Flat blade screwdriver
- Pliers

PARTS LIST:

Description	Qty.	Part #	Description	Qty.	Part #	Description	Qty.	Part #
A hose clamp #44	2	08577	I bolt; 6mm-1.00 x 20mm f/h/a	1	08376	Q bracket L	2	070015
B silicone hose 2.75" id x 2" l	1	08756	J washer; conical, nylon, black	1	08180	R heat shield	1	07476
C intake tube (CH)	1	087057	K bracket twist	1	07144	S edge trim 33" l	1	102498
D grommet; 1" od, 3/16" id, 3/8" thk	1	082001	L washer 1/4" id x 5/8" od - sae	11	08275	T custom radius filter adapter	1	21511
E hose mender	1	08703	M nut 6mm nylock hexhead	4	07553	U hose clamp #80	1	08694
F silicone hose 18" l x 4mm	1	08153	N silicone hose 3.25" id x 2" l	1	08690	V filter	1	RF-1037
G hose clamp #52	3	08610	O bolt; m6-1.00 x 16mm hex hd.	9	07703			
H saddle bracket	1	078855	P washer 6mm wave	6	08174			

NOTE: FAILURE TO FOLLOW INSTALLATION INSTRUCTIONS AND NOT USING THE PROVIDED HARDWARE MAY DAMAGE THE INTAKE TUBE, THROTTLE BODY AND ENGINE.

TO START:

1. Turn off the ignition and disconnect the negative battery cable.
- NOTE:** Disconnecting the negative battery cable erases pre-programmed electronic memories. Write down all memory settings before disconnecting the negative battery cable. Some radios will require an anti-theft code to be entered after the battery is reconnected. The anti-theft code is typically supplied with your owner's manual. In the event your vehicles' anti-theft code cannot be recovered, contact an authorized dealership to obtain your vehicles anti-theft code.



2. Disconnect the mass air sensor electrical connection.



3. Lift up on the release tab to remove the factory zip-tie, as this will be reused in a later step.



4. Squeeze the two hose clamps and slide back using pliers.



5. Remove the two hoses from the intake tube.



6. Disconnect the throttle cable bracket using a 10mm socket.



7. Loosen clamp on the resonator tube using a 10mm socket.

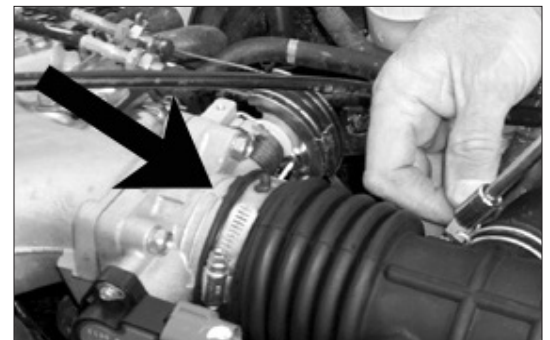

8. Loosen clamp at the throttle body using an 8mm socket.

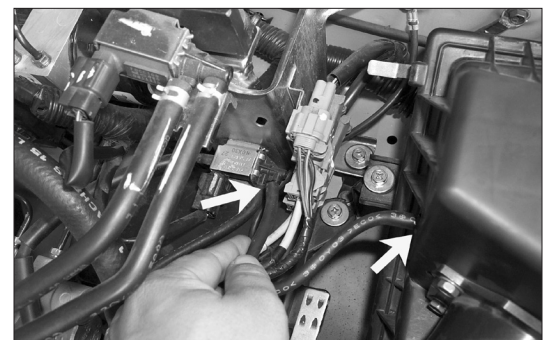

9. Remove vacuum line from bypass solenoid as shown. **NOTE:** It's the vacuum line that connects to the airbox lid.



10. Unlatch the four clips on the air filter housing and remove the top assembly.

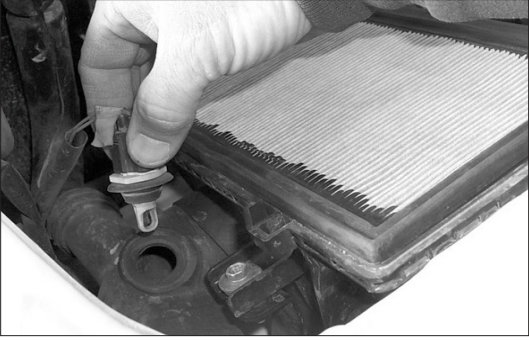

11. Remove the air temp sensor by pulling in an upward direction as shown.

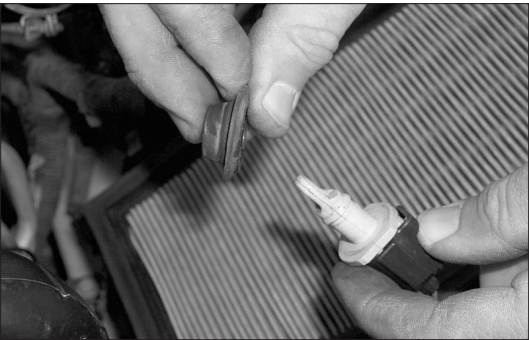

12. Remove rubber grommet from air temp sensor then disconnect the electrical connection and remove temp sensor from vehicle.

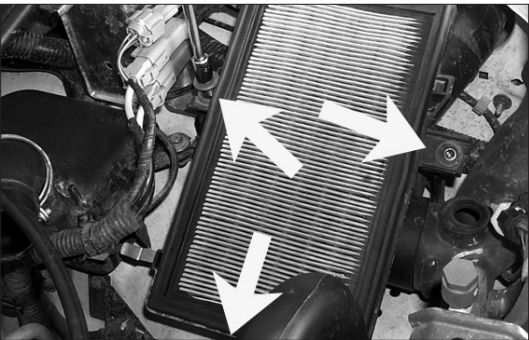

13. Remove the three bolts that secure the lower air filter housing using a 10mm socket.



14. Remove the lower air filter housing as shown. **NOTE: K&N Engineering, Inc., recommends that customers do not discard factory air intake.**



15. Remove the front support bracket using a 10mm socket.

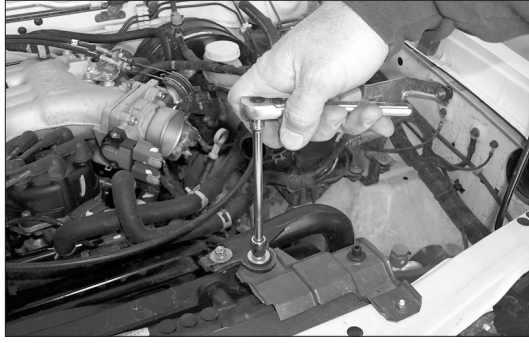

16. Remove bolt from front of resonator using a 10mm socket.

NOTE: Bolt will be re-used.



17. Remove the front resonator assembly as shown.



18. Remove the two bolts on rear resonator box using a 10mm socket.



19. Using pliers, remove the wire loom clip.



20. Remove the resonator box as shown.



21 Loosen hose clamp using a 10mm socket and remove air duct tube from mass air sensor.

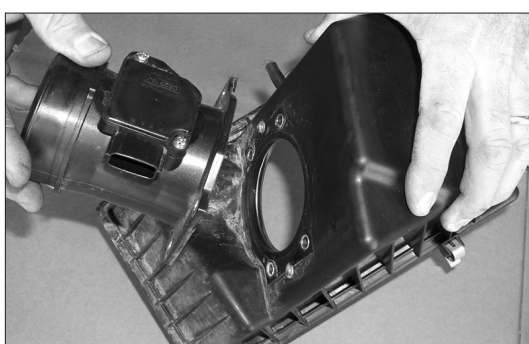

22. Remove the four bolts from mass air sensor housing using a 10mm socket and detach from airbox.

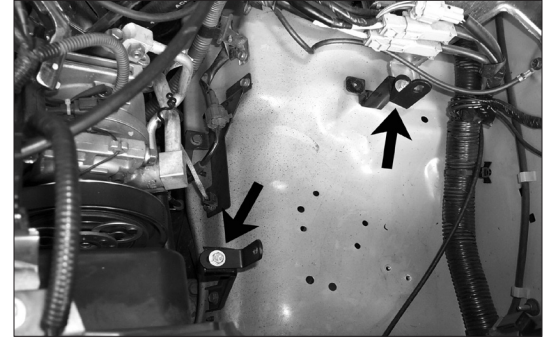

23. Install the two "L" brackets onto the vehicle as shown using the provided hardware.

NOTE: Do not tighten completely.

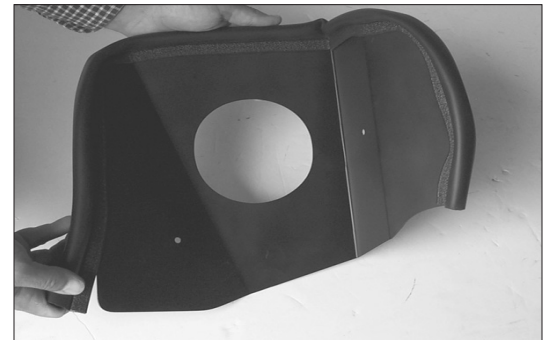

24. Install edge trim onto heat shield as shown. Trim if needed.

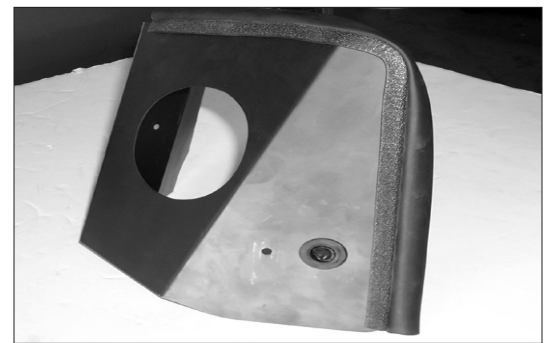

25. Install the rubber grommet that was removed in step 12 and install into heat shield as shown.



26. Install the air temp sensor that was removed in step 12 into the heat shield as shown.

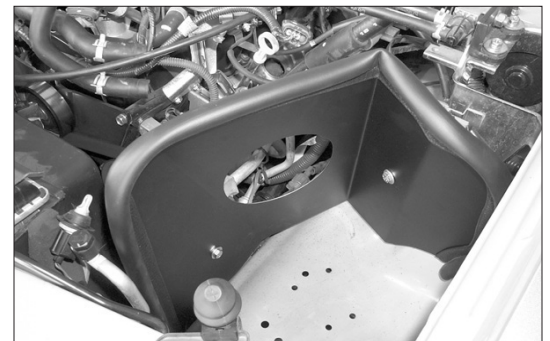

27. Install the heat shield into the vehicle as shown using the provided hardware.

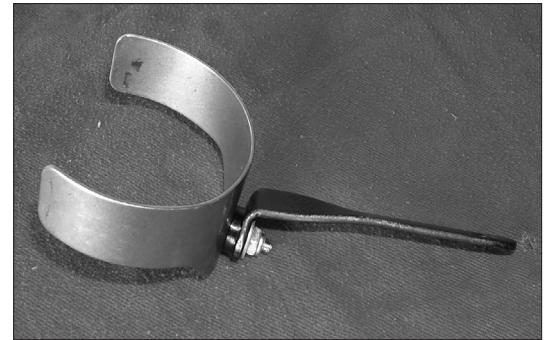

28. Install the saddle bracket onto the "L" bracket as shown.



29. Remove the AC compressor mounting bolt.



30. Install the saddle bracket assembly onto the AC compressor using the bolt that was removed in the previous step.

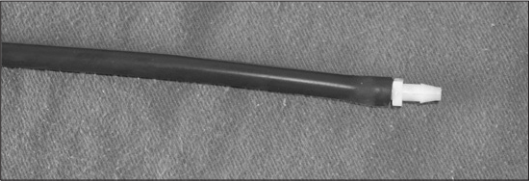

31. Install the provided hose mender into the 4mm hose as shown.

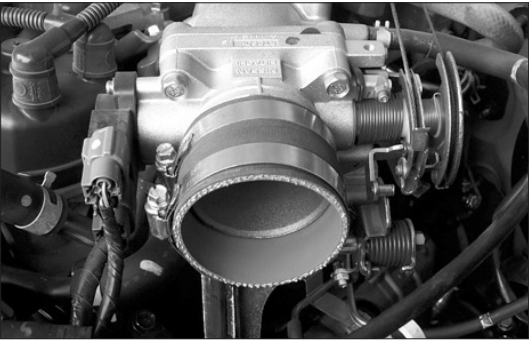

32. Install the silicone hose onto the throttle body with the provided hose clamp.

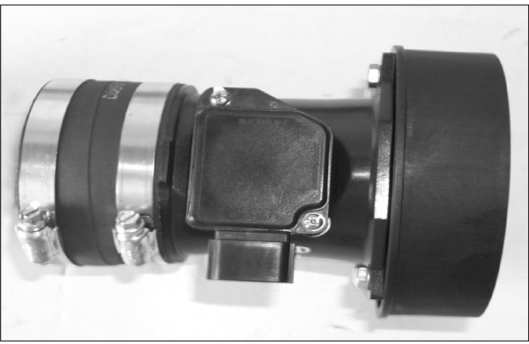

33. Install the silicone hose and the filter adapter onto the mass air sensor with the provided hardware.

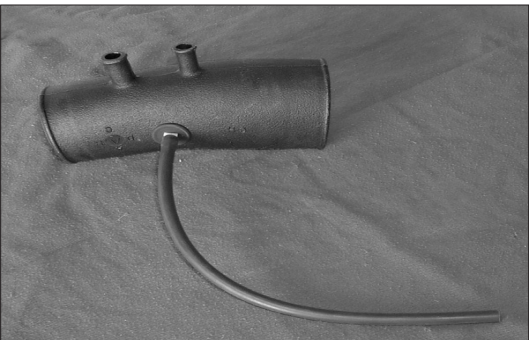

34. Install the the provided grommet and 4mm hose onto the intake tube as shown.



35. Install the K&N® intake tube onto the throttle body and secure the saddle bracket to the intake tube with the provided hose clamps.

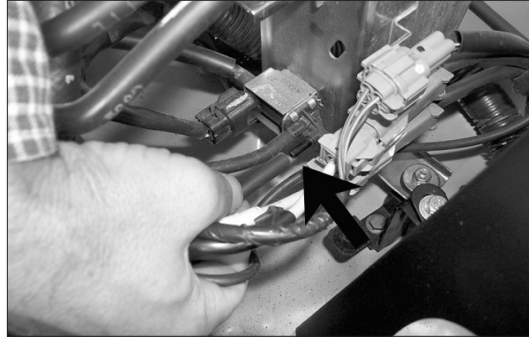

36. Reconnect the bypass solenoid vacuum line to the solenoid from the intake tube as shown.



37. Reconnect the two vent lines to the intake tube.

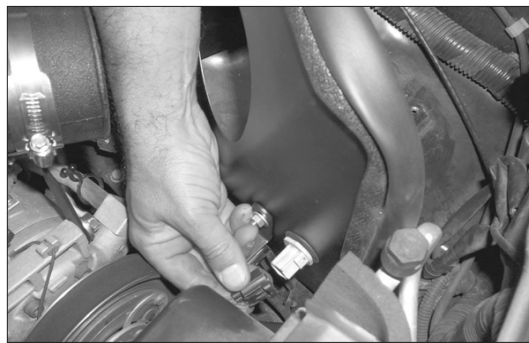

38. Reconnect the air temp sensor electrical connection as shown.

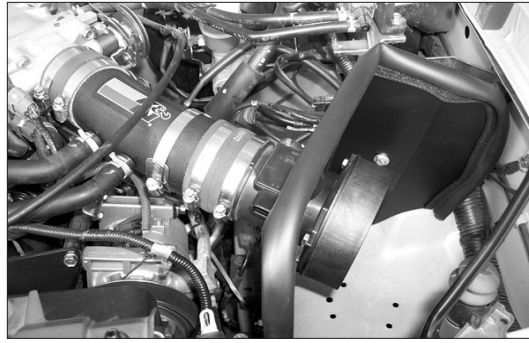

39. Install the mass air assembly onto the intake tube.



40. Install the K&N® air filter onto the intake tube.



41. Reconnect the mass air electrical connection.

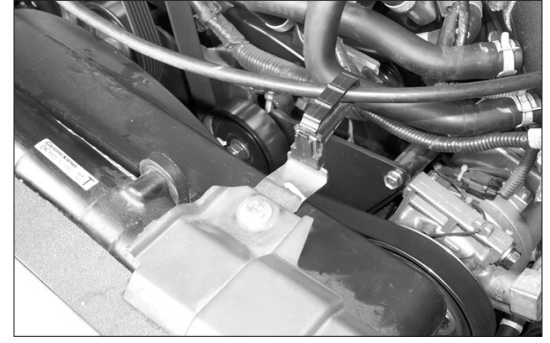

42. Re-install the throttle cable bracket using the provided nut and bolt.

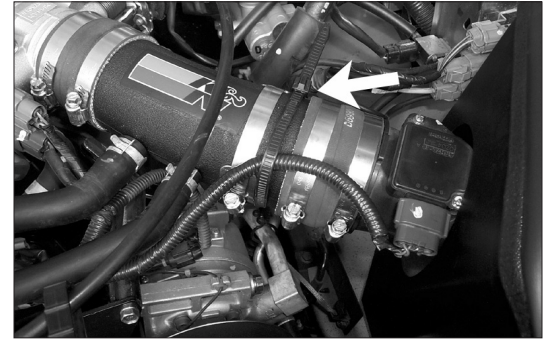

43. Re-install the zip-tie that was removed in step 3.



44. Reconnect the vehicle's negative battery cable. Double check to make sure everything is tight and properly positioned before starting the vehicle.

45. The C.A.R.B. exemption sticker, (attached), must be visible under the hood so that an emissions inspector can see it when the vehicle is required to be tested for emissions. California requires testing every two years, other states may vary.

46. It will be necessary for all K&N® high flow intake systems to be checked periodically for realignment, clearance and tightening of all connections. Failure to follow the above instructions or proper maintenance may void warranty.

ROAD TESTING:

1. Start the engine with the transmission in neutral or park. Listen for air leaks or odd noises. For air leaks secure hoses and connections. For odd noises, find cause and repair before proceeding. This kit will function identically to the factory system except for being louder and much more responsive.

2. Test drive the vehicle. Listen for odd noises or rattles and fix as necessary.

3. If road test is fine, you can now enjoy the added power and performance from your kit.

4. K&N Engineering, Inc., suggests checking the air filter element periodically for excessive dirt build-up. When the element becomes covered in dirt (or once a year), service it according to the instructions on the Recharger® service kit, part number 99-5050 or 99-5000.