



INSTALLATION INSTRUCTIONS

57-3513
HONDA
2001-05 Civic
L4-1.7L

TOOLS NEEDED:

- Flat Blade
- Screwdriver
- 10mm Wrench
- 10mm Socket
- Ratchet

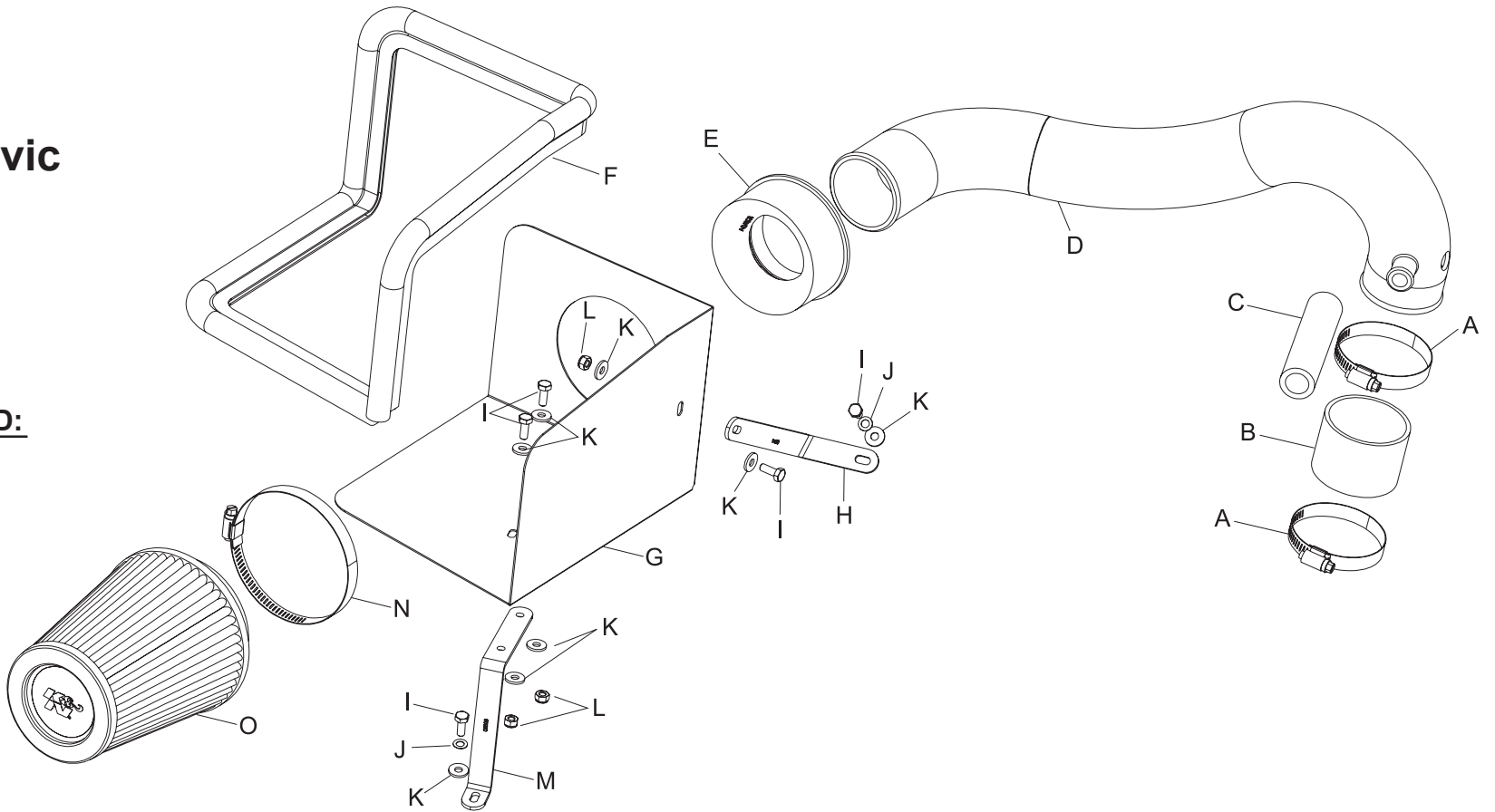

PARTS LIST:

Description	Qty.	Part #	Description	Qty.	Part #	Description	Qty.	Part #	Description	Qty.	Part #
A Hose clamp #40	2	08554	E Filter adapter	1	088005-1	I Bolt, 6mm	5	07703	M Bracket, "Z"	1	08020
B 2.5" ID silicone hose	1	08284	F Edge trim 46"L	1	102487	J Wave washer, 6mm	2	08174	N Hose clamp #64	1	08648
C Hose; 3/4"ID x 4-3/4"L	1	08606	G Heat shield	1	07447	K Washer, 1/4"	8	08275	O Air Filter	1	RP-4970
D Intake tube	1	087038	H Bracket	1	08016	L Nylock nut, 6mm	3	07553			

NOTE: FAILURE TO FOLLOW INSTALLATION INSTRUCTIONS AND NOT USING THE PROVIDED HARDWARE MAY DAMAGE THE INTAKE TUBE, THROTTLE BODY AND ENGINE.

TO START:

1. Turn off the ignition and disconnect the negative battery cable.
NOTE: Disconnecting the negative battery cable erases pre-programmed electronic memories. Write down all memory settings before disconnecting the negative battery cable. Some radios will require an anti-theft code to be entered after the battery is reconnected. The anti-theft code is typically supplied with your owner's manual. In the event your vehicles' anti-theft code cannot be recovered, contact an authorized dealership to obtain your vehicles anti-theft code.

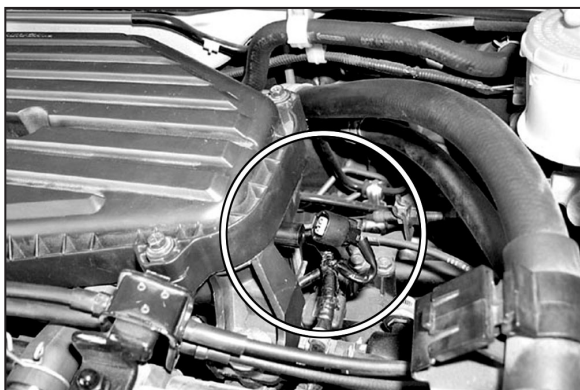

2. Disconnect the air temperature sensor electrical connection.



3. Detach the crankcase vent hose from the vent fitting on the valve cover.

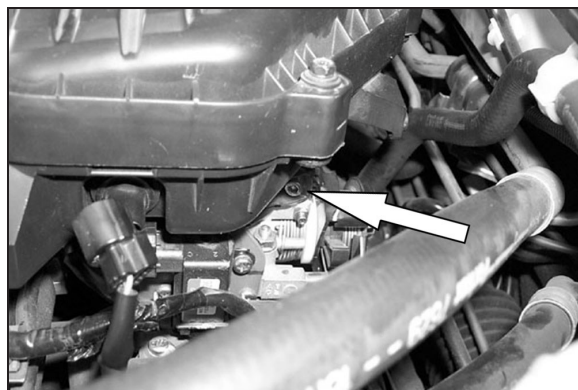

4. Loosen the hose clamp that secures the flange on the underside of the airbox to the throttle body.

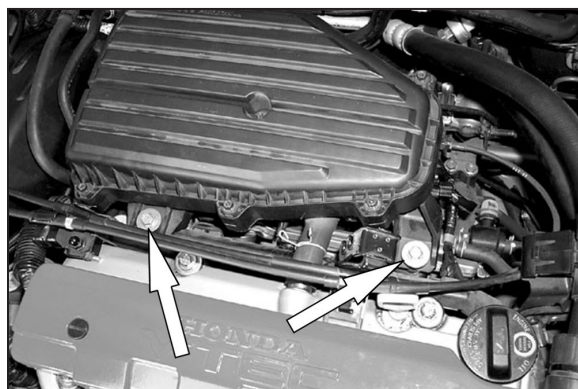

5. Loosen and remove the two bolts that retain the airbox to its mounting bracket .

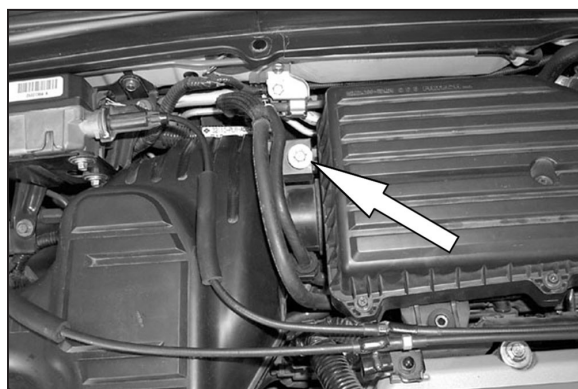

6. Loosen and remove the bolt that retains the airbox to the resonator box.



7. Pull upward firmly on the airbox to release it from the throttle body and remove.

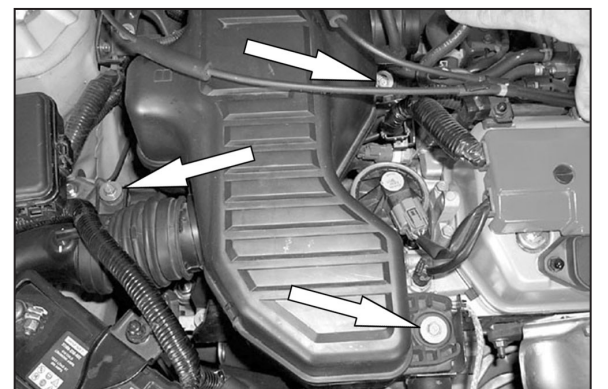

8. Loosen and remove the three bolts that retain the resonator box to its mounting bracket.



9. Detach the air inlet rubber boot and remove the resonator box.



10. Loosen and remove the two bolts that retain the air inlet duct to the inner fender apron and its mounting bracket. Then remove air inlet duct.

NOTE: K&N Engineering, Inc., recommends that customers do not discard factory air intake.



11. Install the trim seal onto the heat shield as show. Trim if necessary.

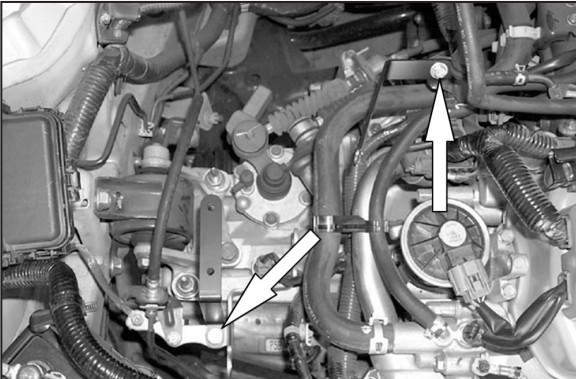

12. Install the two brackets onto the vehicle as shown with the hardware provided.



13. Install the heat shield attaching it to the upper rear and lower mounting brackets using the hardware provided..

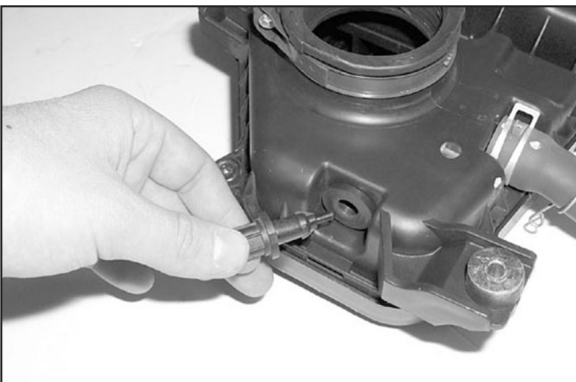

14. Remove the air temp sensor and grommet from the stock airbox.

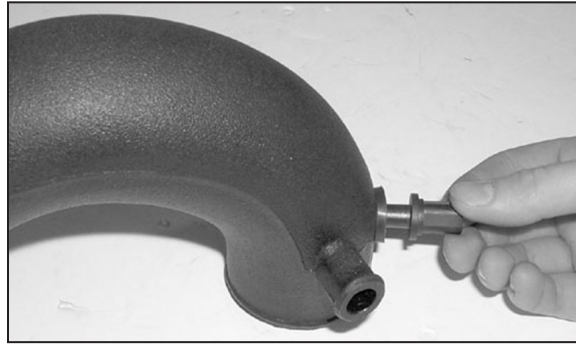

15. Insert the air temp. sensor grommet into the hole in the K&N® intake tube.

16. Insert the air temp. sensor into the grommet in the K&N® intake tube as shown.



17. Attach the silicone hose provided onto the throttle body using the provided hose clamps.



18. Install the radius adapter onto the K&N® intake tube.

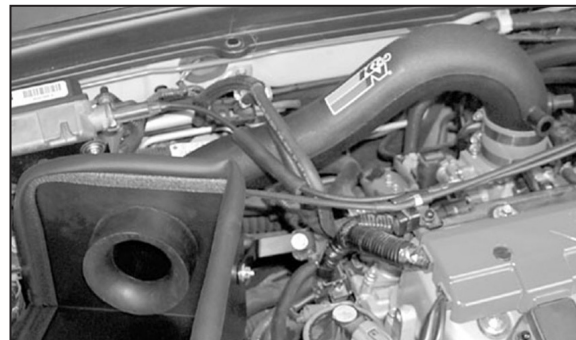

19. Install the K&N® intake tube by inserting the radius adapter into the heat shield and then the silicone hose onto the throttle body.

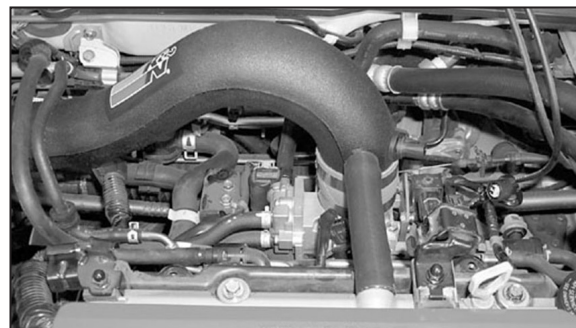

20. Attach the vent hose provided onto the vent fitting on the K&N® intake tube and valve cover.



21. Reconnect the air temp. sensor electrical connection.



22. Install the K&N® Air Filter onto the radius adapter and tighten the hose clamp provided.



23. Align the K&N® intake tube for best clearance and tighten hose clamp at the throttle body and tighten all hardware.

24. Reconnect the vehicle's negative battery cable. Double check to make sure everything is tight and properly positioned before starting the vehicle.

25. The C.A.R.B. exemption sticker, (attached), must be visible under the hood so that an emissions inspector can see it when the vehicle is required to be tested for emissions. California requires testing every two years, other states may vary.

26. It will be necessary for all K&N® high flow intake systems to be checked periodically for realignment, clearance and tightening of all connections. Failure to follow the above instructions or proper maintenance may void warranty.

ROAD TESTING:

1. Start the engine with the transmission in neutral or park, and the parking brake engaged. Listen for air leaks or odd noises. For air leaks secure hoses and connections. For odd noises, find cause and repair before proceeding. This kit will function identically to the factory system except for being louder and much more responsive.

2. Test drive the vehicle. Listen for odd noises or rattles and fix as necessary.

3. If road test is fine, you can now enjoy the added power and performance from your kit.

4. K&N Engineering, Inc., requires cleaning the intake system's air filter element every 100,000 miles. When used in dusty or off-road environments, our filters will require cleaning more often. We recommend that you visually inspect your filter once every 25,000 miles to determine if the screen is still visible. When the screen is no longer visible some place on the filter element, it is time to clean it. To clean and re-oil, purchase our filter Recharger® service kit, part number 99-5050 or 99-5000 and follow the easy instructions.