

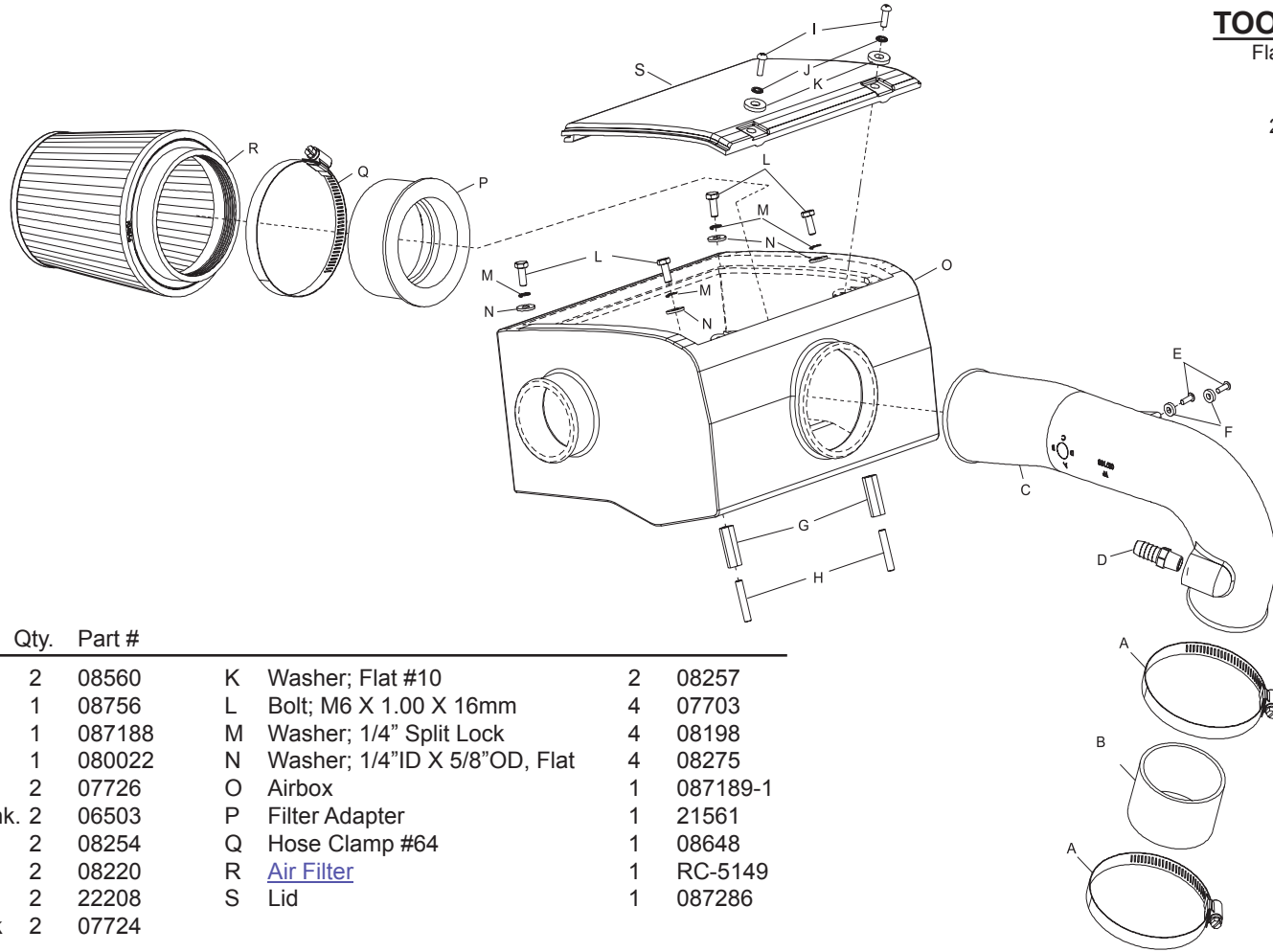

# INSTALLATION INSTRUCTIONS

**57-3056**  
**CHEVROLET**  
**2006-10 HHR**  
**L4-2.4L**  
**2010 HHR**  
**L4-2.2L**



**TOOLS NEEDED:**

- Flat Blade Screwdriver
- 20 Torx Socket
- 27 Torx Socket
- 2.5mm Allen Wrench
- 3mm Allen Wrench
- 4mm Allen Wrench
- 7/16" Wrench
- Ratchet
- Extension

**PARTS LIST:**

Description	Qty.	Part #
A Hose Clamp; #44	2	08560
B Hose; 2.75"ID X 2"l, Silicone	1	08756
C Intake Tube	1	087188
D Vent; Strt 1/2" Hose, 1/4" NPT	1	080022
E Screw; M4-.7x12mm, B/H/A	2	07726
F Spacer; .437"odx.200"idx.115"Thk.	2	06503
G Nut; 6mm X 1.33"L, Coupling	2	08254
H Stud; 6mm-1.00 X 35mm L, SS	2	08220
I Bolt; M5	2	22208
J Washer; 5mm Internal Star, Lock	2	07724
K Washer; Flat #10	2	08257
L Bolt; M6 X 1.00 X 16mm	4	07703
M Washer; 1/4" Split Lock	4	08198
N Washer; 1/4"ID X 5/8"OD, Flat	4	08275
O Airbox	1	087189-1
P Filter Adapter	1	21561
Q Hose Clamp #64	1	08648
R <a href="#">Air Filter</a>	1	RC-5149
S Lid	1	087286

**NOTE: FAILURE TO FOLLOW INSTALLATION INSTRUCTIONS AND NOT USING THE PROVIDED HARDWARE MAY DAMAGE THE INTAKE TUBE, THROTTLE BODY AND ENGINE.**

**TO START:**

1. Turn off the ignition and disconnect the negative battery cable.  
**NOTE: Disconnecting the negative battery cable erases pre-programmed electronic memories. Write down all memory settings before disconnecting the negative battery cable. Some radios will require an anti-theft code to be entered after the battery is reconnected. The anti-theft code is typically supplied with your owner's manual. In the event your vehicles' anti-theft code cannot be recovered, contact an authorized dealership to obtain your vehicles anti-theft code.**

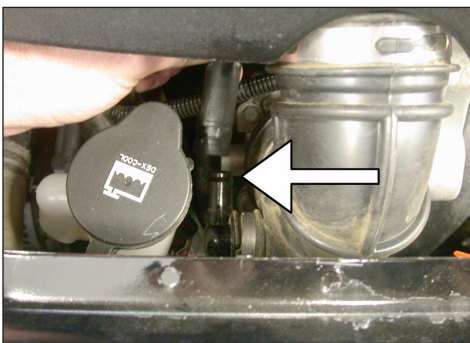

2. Loosen the hose clamp, which secures the crankcase vent hose to the stock intake tube, and then disconnect the crankcase vent hose from the stock intake tube as shown.

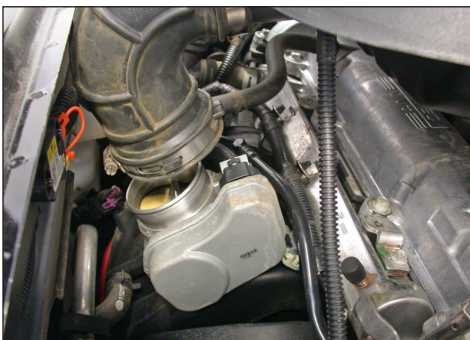

3. Loosen the hose clamp, which secures the intake tube to the throttle body, and then pull up on the intake tube/airbox assembly to dislodge it from the mounting grommets and disconnect the intake tube from the throttle body.

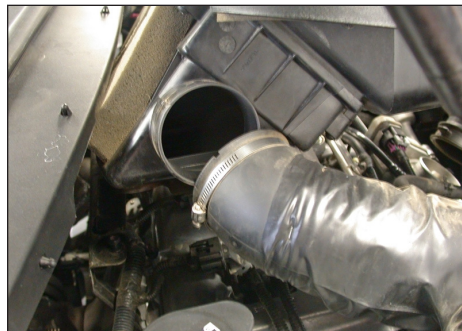

4. Lift the airbox assembly up enough to gain access to the fresh air supply hose clamp, then loosen the clamp and disconnect the fresh air supply hose from the airbox assembly.

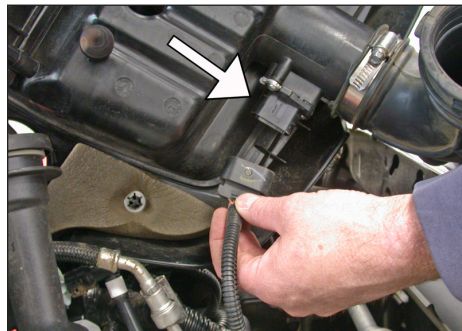

5. Flip the airbox assembly up towards the driver's side of the vehicle to gain access to the mass air sensor electrical connection, and then disconnect the mass air sensor electrical connection as shown.



6. Remove the airbox assembly from the vehicle.  
**NOTE: K&N Engineering, Inc., recommends that customers do not discard factory air intake.**

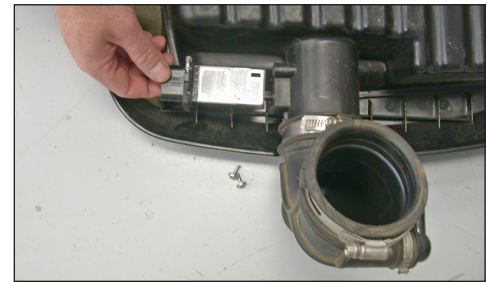

7. Remove the two screws securing the mass air sensor to the stock intake tube and then remove the sensor as shown.

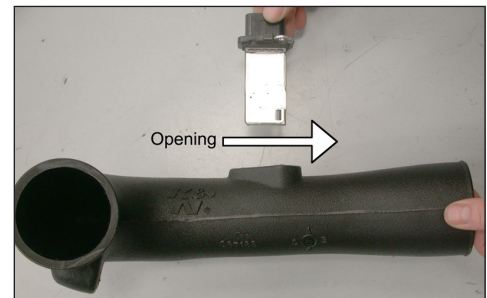

8. Install the mass air sensor into the intake tube as shown.

**NOTE: The small opening in the sensor will be pointed towards the filter end of the tube.**



9. Secure the mass air sensor to the intake tube with the screws and spacers provided.



10. Install the supplied crankcase vent fitting into the intake tube as shown.  
**NOTE: Plastic NPT fittings are easy to cross thread. Install the vent fitting "hand" tight, then turn it two complete turns with a wrench.**

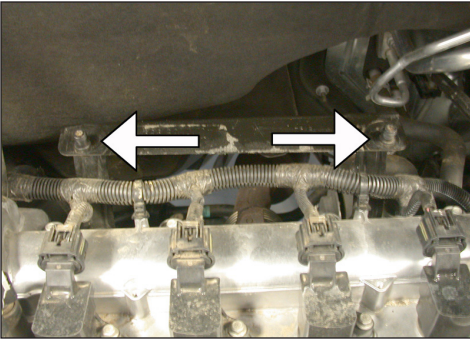

11. Remove the two stock airbox mounting anchors shown from the mounting bracket.

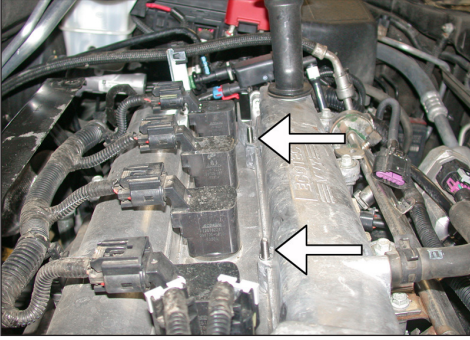

12. Install the two supplied 6mm studs into the valve cover as shown.

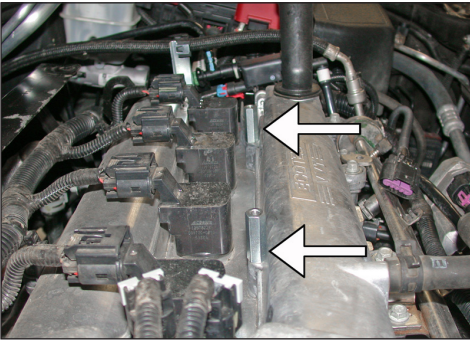

13. Thread and tighten the two coupling nuts onto the studs installed in step #12.

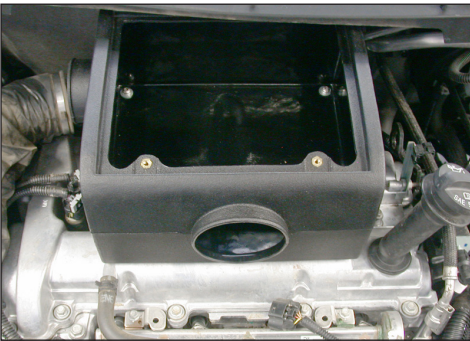

14. Install the K&N® airbox onto the engine. Using the supplied hardware, secure the airbox to the rear mounting bracket first and then to the coupling nuts installed in step #13.

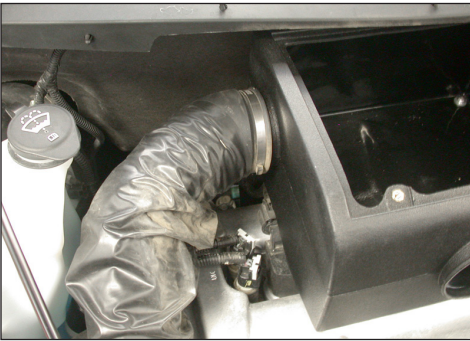

15. Install the fresh air supply hose onto the K&N® airbox and secure with the factory hose clamp.



16. Install the silicone hose (08756) onto the throttle body and secure with the provided hose clamp.



17. Install the filter adapter into the K&N® air filter as shown.

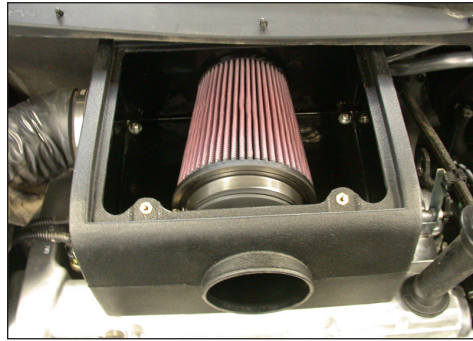

18. Place the filter assembly into the K&N® airbox as shown.

**NOTE: Drycharger® air filter wrap; part # RC-5149DK is available to purchase separately.**

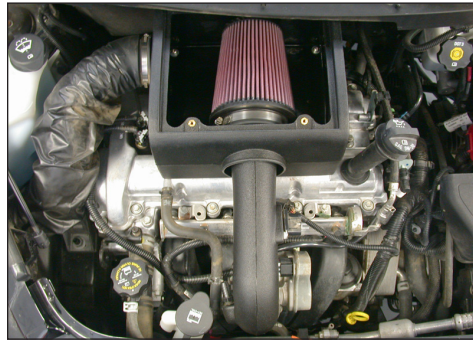

19. Install the K&N® intake tube through the opening in the airbox and into the filter assembly. Then install the intake tube into the silicone hose at the throttle body and secure the filter and tube with the provided hose clamps.

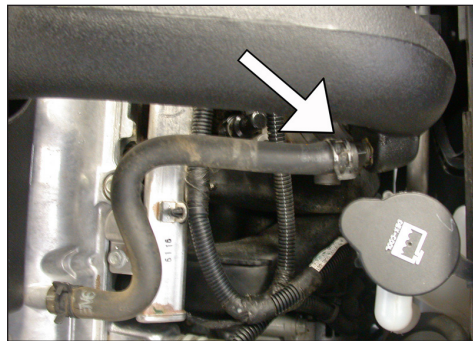

20. Install the stock crankcase vent hose onto the fitting on the K&N® intake tube and secure with the stock hose clamp.



21. Install the K&N® airbox lid and secure with the provided hardware as shown.

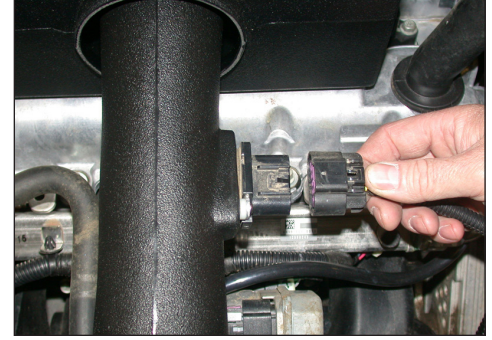

22. Reconnect the vehicle's mass air sensor electrical connection.

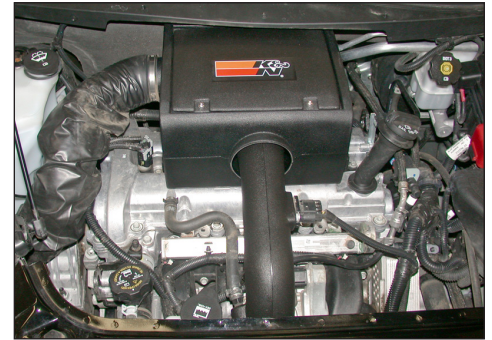

23. Reconnect the vehicle's negative battery cable. Double check to make sure everything is tight and properly positioned before starting the vehicle.

24. The C.A.R.B. exemption sticker, (attached), must be visible under the hood so that an emissions inspector can see it when the vehicle is required to be tested for emissions. California requires testing every two years, other states may vary.

25. It will be necessary for all K&N® high flow intake systems to be checked periodically for realignment, clearance and tightening of all connections. Failure to follow the above instructions or proper maintenance may void warranty.

#### ROAD TESTING:

1. Start the engine with the transmission in neutral or park, and the parking brake engaged. Listen for air leaks or odd noises. For air leaks secure hoses and connections. For odd noises, find cause and repair before proceeding. This kit will function identically to the factory system except for being louder and much more responsive.

2. Test drive the vehicle. Listen for odd noises or rattles and fix as necessary.

3. If road test is fine, you can now enjoy the added power and performance from your kit.

4. K&N Engineering, Inc., suggests checking the air filter element periodically for excessive dirt build-up. When the element becomes covered in dirt (or once a year), service it according to the instructions on the Recharger® service kit, part number 99-5050 or 99-5000.