



INSTALLATION INSTRUCTIONS

57-1559
JEEP
2008-09 Liberty
V6-3.7L

NOTE: This kit was not designed to fit vehicles with a body lift.

TOOLS NEEDED:

- Drill Motor
- 1/4" Drill
- Flat Blade Screwdriver
- Ratchet
- Extension
- 10mm Socket
- 13mm Socket
- 10mm Wrench
- 13mm Wrench
- Knife

PARTS LIST:

Desc.	QTY.	Part #	Desc.	QTY.	Part #	Desc.	QTY.	Part #
A Hose Clamp #44	1	08560	K Washer; 5/16"ID X 5/8"OD, Flat	1	08276	U Bolt; M6 X 1.00" X 20MM Hex, SS	1	07795
B Hose; 2-3/4" to 3-1/4" X 2"L, Black Silicone	1	084034	L Hose Clamp #56	2	08620	V Bracket; "L", SML, STL, FB/PC	1	070066
C Hose Clamp #48	1	08601	M Heat Shield	1	07690	W Stud; M6-1.00 M/M, Rubber Mntd.	1	07027
D Intake Tube	1	087128	N Edge Trim (20")	1	102494	X Hose; 3.5"ID X 2"L, Black Silicone	1	08698
E Grommet; 1"OD, 1/2"ID, 1/2"Thk.	1	08064	O Edge Trim (26")	1	102488	Y Adaptor; #380	1	21512-1
F Vent; 90DEG, 1/2"Hose, 1/4"NPT, Plastic	1	08110FK	P Edge Trim (44")	1	102486	Z Hose Clamp #104	1	08697
G Hose; 1/2"ID X 14"L, Black Silicone	1	08402	Q Bracket; "L", STL, FB/PC	1	070092	AA Air Filter	1	RF-1048
H Bracket; "Z" Mild STL, FB/PC	1	010064	R Bolt; 6MM-1.00 X 16MM, SS	1	07812			
I Bolt; 8MM-1.25 X 16MM, Hex	1	07844	S Washer; 1/4"ID X 5/8"OD - SAE	7	08275			
J Washer; 8MM Spring (Wave)	1	08239	T Nut; 6MM Nylock, Hex, SS	5	07512			

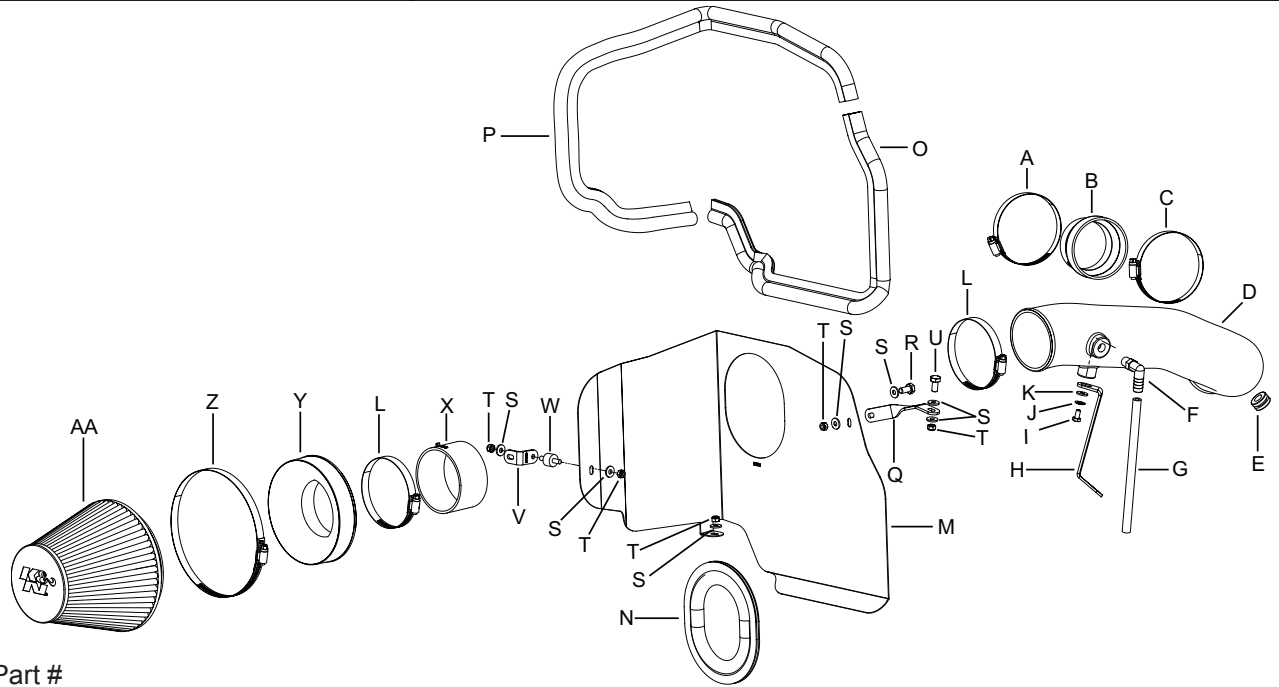

NOTE: FAILURE TO FOLLOW INSTALLATION INSTRUCTIONS AND NOT USING THE PROVIDED HARDWARE MAY DAMAGE THE INTAKE TUBE, THROTTLE BODY AND ENGINE.

TO START:

1. Turn off the ignition and disconnect the negative battery cable.

NOTE: Disconnecting the negative battery cable erases pre-programmed electronic memories. Write down all memory settings before disconnecting the negative battery cable. Some radios will require an anti-theft code to be entered after the battery is reconnected. The anti-theft code is typically supplied with your owner's manual. In the event your vehicles' anti-theft code cannot be recovered, contact an authorized dealership to obtain your vehicles anti-theft code.



2. Release the red locking tab and then disconnect the temperature sensor electrical connection.



3. Loosen the two hose clamps which secure the stock intake tube to the throttle body and air box, then remove the intake tube from the vehicle.



4. Disconnect the crank case vent hose from the air box as shown.



5. Lift up firmly to dislodge the air box from the mounting grommets and then remove the air box from the vehicle.

NOTE: K&N Engineering, Inc., recommends that customers do not discard factory air intake.



6. Remove the crank case vent tube assembly from the valve cover as shown.

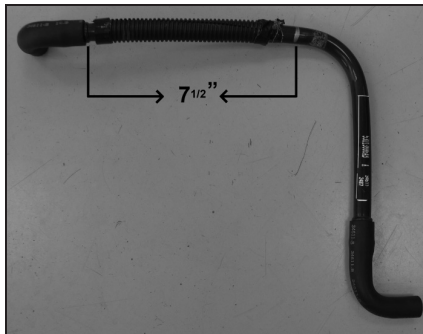

7. Using a knife, cut the crank case vent hose 7-1/2" from the valve cover elbow fitting as indicated.



8. Reinstall the modified crank case vent tube onto the valve cover as shown.



9. Install the silicone hose (084034) onto the throttle body and secure with the provided hose clamp.

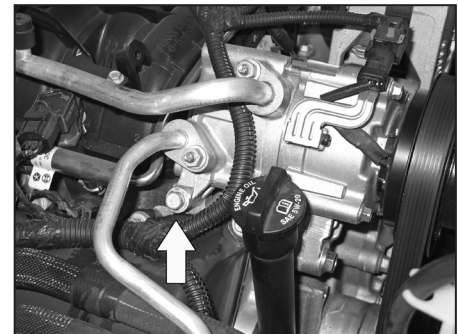

10. Remove the lower rear A/C compressor mounting bolt shown.

NOTE: This bolt will be reused in the next step.

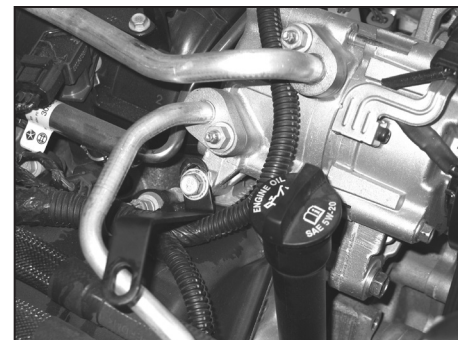

11. Install the tube mounting bracket (010064) onto the A/C compressor and secure with factory bolt removed in the previous step.

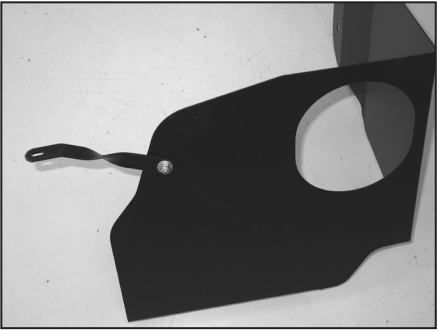

12. Secure the heat shield mounting bracket (070092) onto the heat shield as shown using the provided hardware.

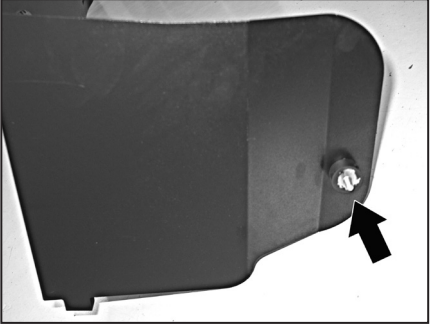

13. Secure the provided rubber mounted stud to the heat shield as shown using the provided hardware.



14. Install the provided edge trim into the hole of the heat shield as shown.
NOTE: Some trimming of the edge trim will be necessary.

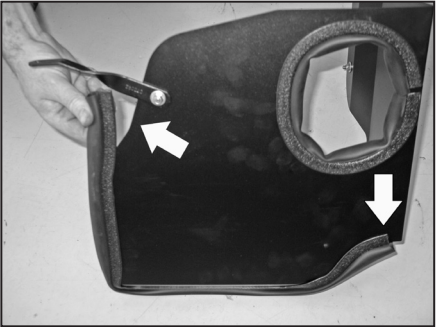

15. Install the provided edge trim onto the heat shield as shown.
NOTE: Some trimming of the edge trim will be necessary.

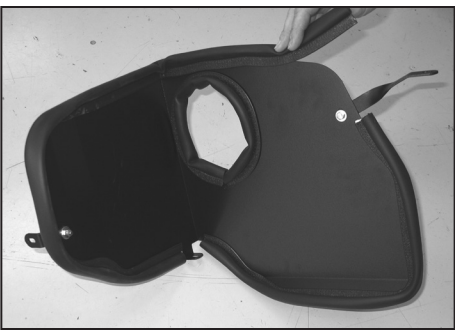

16. Install the provided edge trim onto the heat shield as shown.
NOTE: Some trimming of the edge trim will be necessary.

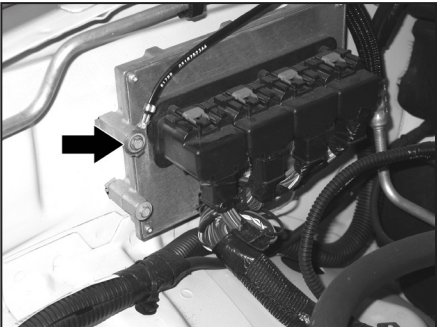

17. Remove the forward/upper ECU mounting bolt and ground strap.

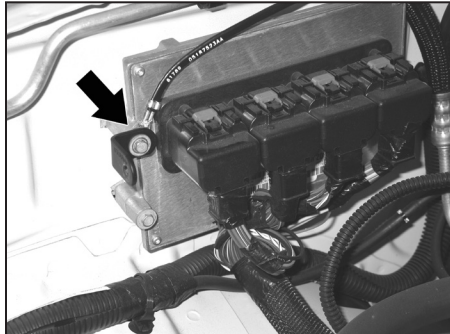

18. Install the heat shield mounting bracket (070066) onto the ECU and secure with the factory bolt removed in the previous step.
NOTE: Be sure to place the slotted end of the bracket on to the ECU. Be sure to place the ground strap between the bracket and ECU as shown.



19. Using the provided template, place a mark onto the radiator core support for a hole to be drilled for the heat shield mounting bracket.

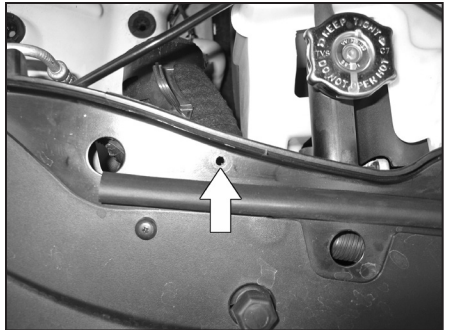

20. Drill a 1/4" O.D. hole at the marked location.



21. Remove the fresh air supply duct from the radiator core support as shown.

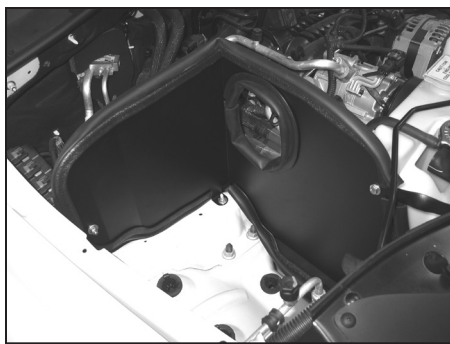

22. Install the heat shield assembly into the vehicle. Secure the rear of the heat shield to the mounting bracket installed onto the ECU. Secure the front heat shield mounting bracket to the radiator core support at the drilled location. Secure the bottom of the heat shield to the inner fender stud.

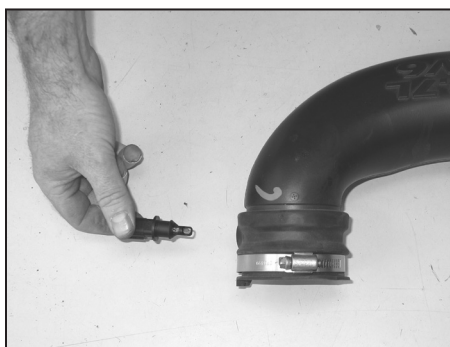

23. Remove the air temperature sensor from the factory intake tube as shown.
NOTE: Handle the air temperature sensor with care as it is very fragile.

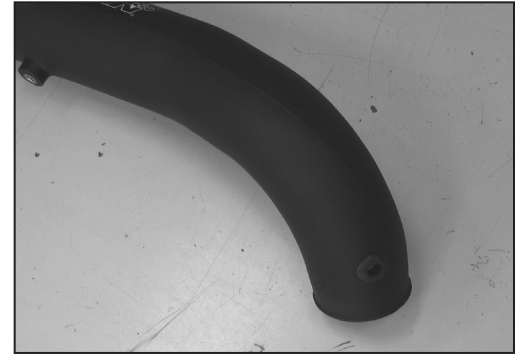

24. Install the supplied grommet into the intake tube as shown.



25. Install the air temperature sensor into the grommet installed into the intake tube as shown.
NOTE: Handle the air temperature sensor with care as it is very fragile.



26. Install the 90° 1/4" npt fitting into the intake tube as shown.
NOTE: Plastic NPT fittings are easy to cross thread. Install the vent fitting "hand" tight, then turn it two complete turns with a wrench.



27. Install the intake tube into the silicone hose at the throttle body and align with the tube mounting bracket installed during step #11. Secure the intake tube with the provided hose clamp and hardware.

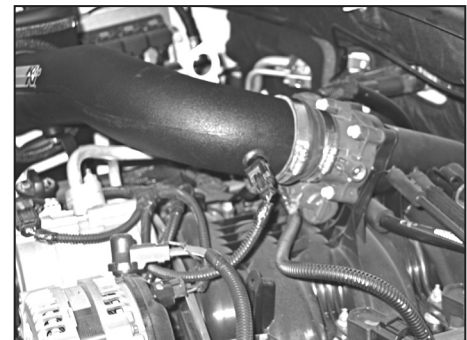

28. Reconnect the inlet air temperature sensor electrical connection.



29. Connect the provided silicone vent hose to the modified factory vent tube and then connect the open end to the intake tube as shown.



30. Install the filter adapter into the K&N [air filter](#) and secure with the provided hose clamp.
NOTE: Drycharger® air filter wrap; part # RF-1048DK is available to purchase separately.



31. Install the provided silicone hose (08698) onto the filter assembly and secure with the provided hose clamp.

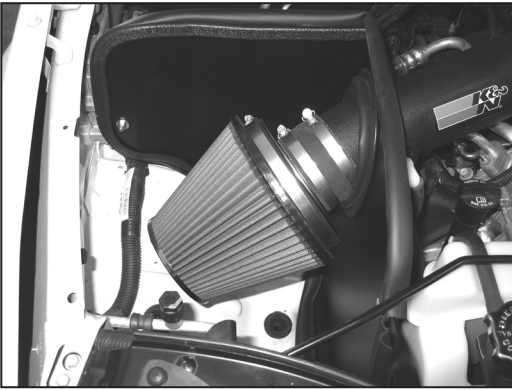

32. Install the filter assembly onto the intake tube and secure with the provided hose clamp.



33. Reconnect the vehicle's negative battery cable. Double check to make sure everything is tight and properly positioned before starting the vehicle.

34. The C.A.R.B. exemption sticker, (attached), must be visible under the hood so that an emissions inspector can see it when the vehicle is required to be tested for emissions. California requires testing every two years, other states may vary.

35. It will be necessary for all K&N® high flow intake systems to be checked periodically for realignment, clearance and tightening of all connections. Failure to follow the above instructions or proper maintenance may void warranty.

ROAD TESTING:

1. Start the engine with the transmission in neutral or park, and the parking brake engaged. Listen for air leaks or odd noises. For air leaks secure hoses and connections. For odd noises, find cause and repair before proceeding. This kit will function identically to the factory system except for being louder and much more responsive.

2. Test drive the vehicle. Listen for odd noises or rattles and fix as necessary.

3. If road test is fine, you can now enjoy the added power and performance from your kit.

4. K&N Engineering, Inc., requires cleaning the intake system's air filter element every 100,000 miles. When used in dusty or off-road environments, our filters will require cleaning more often. We recommend that you visually inspect your filter once every 25,000 miles to determine if the screen is still visible. When the screen is no longer visible some place on the filter element, it is time to clean it. To clean and re-oil, purchase our filter Recharger® service kit, part number 99-5050 or 99-5000 and follow the easy instructions.

Template for Step 19.

