



INSTALLATION INSTRUCTIONS

57-1557

DODGE

2007-09 Ram 2500 / 3500

L6-6.7L Turbo Diesel

NOTE: This kit was not designed to fit vehicles with a body lift.

TOOLS NEEDED:

- Ratchet
- Extension 9/16"
- 15mm
- 13mm
- 10mm
- 7mm Socket
- Pliers
- 5mm Allen Wrench
- 4mm Allen Wrench
- 3mm Allen Wrench
- 2.5mm Allen Wrench

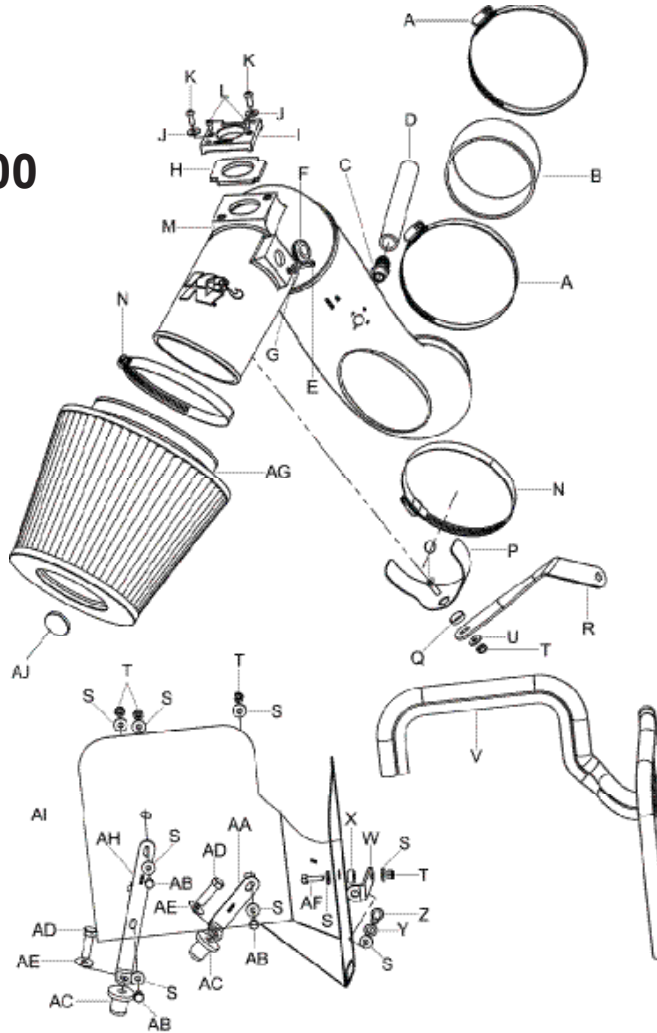

PARTS LIST:

Description	Qty.	Part #
A	2	08645
B	1	08761
C	1	08911
D	1	084008
E	1	07793
F	1	080544
G	1	06503
H	1	09074
I	1	21507
J	2	08269
K	2	07730
L	2	07733
M	1	087223
N	2	08671
O	1	08376
P	1	078855
Q	1	08180
R	1	07160
S	9	08275
T	5	07512
U	1	08276
V	1	102486
W	1	07158
X	1	06555
Y	1	08239
Z	1	07748
AA	1	06723
AB	3	07812
AC	2	08163
AD	2	07779
AE	2	08134
AF	1	07795
AG	1	RC-5142
AH	1	06722
AI	1	07627
AJ	1	21684-1

NOTE: FAILURE TO FOLLOW INSTALLATION INSTRUCTIONS AND NOT USING THE PROVIDED HARDWARE MAY DAMAGE THE INTAKE TUBE, THROTTLE BODY AND ENGINE.

TO START:

1. Turn off the ignition and disconnect the vehicles negative battery cable.



2. Release the red locking clip and then disconnect the mass air sensor electrical connection.

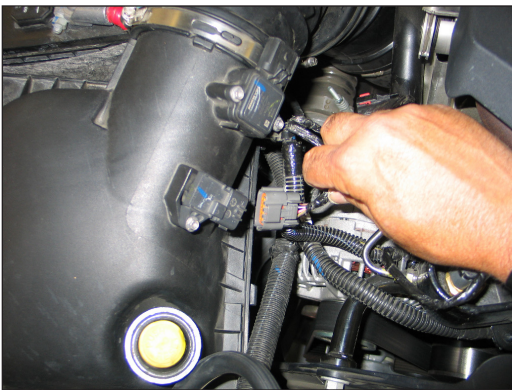

3. Disconnect the inlet air temperature sensor electrical connection and then unhook the wiring harness from the air box.

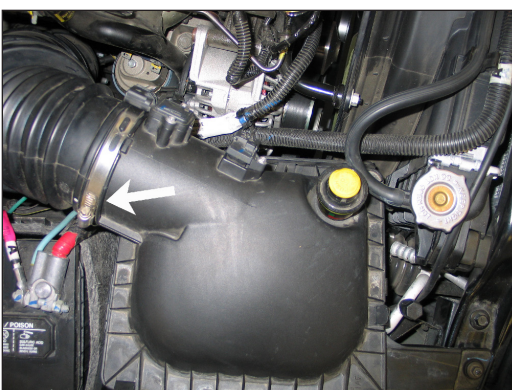

4. Loosen the hose clamp which secures the stock intake tube to the upper air box housing.

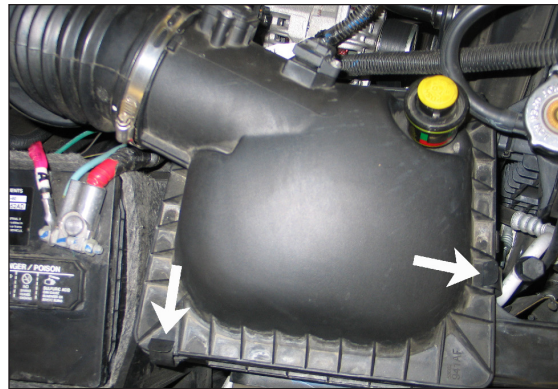

5. Release the two upper air box retaining clips shown.



6. Remove the upper air box housing from the lower air box housing.

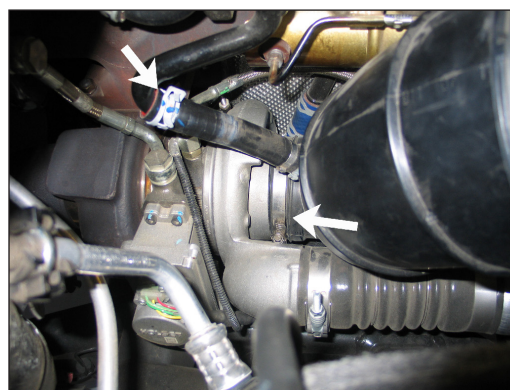

7. Release the tension on the air injection vent hose clamp and the hose clamp which secures the intake tube to the turbo inlet.



8. Remove the stock intake tube from the vehicle.

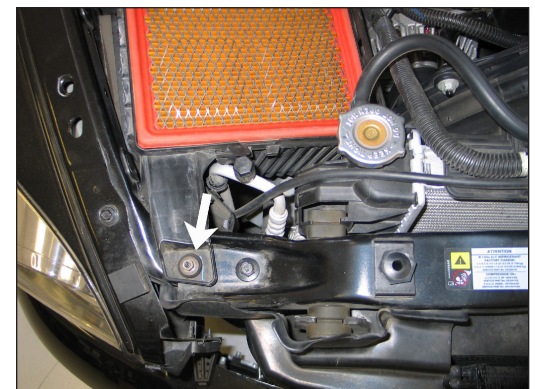

9. Remove the nut which secures the front of the lower air box housing to the radiator core support.



10. Firmly pull the lower air box assembly up to disengage it from the mounting grommets and then remove it from the vehicle.

NOTE: K&N Engineering, Inc., recommends that customers do not discard factory air intake.

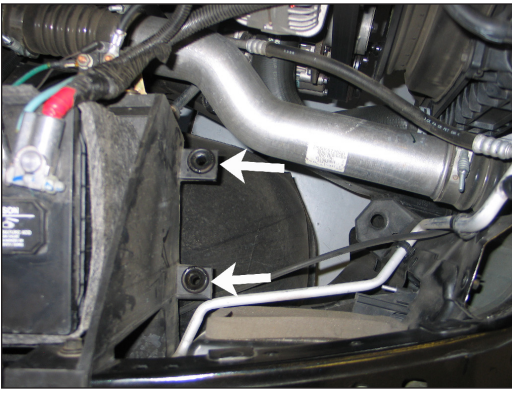

11. Remove the two lower air box mounting grommets from the vehicle.

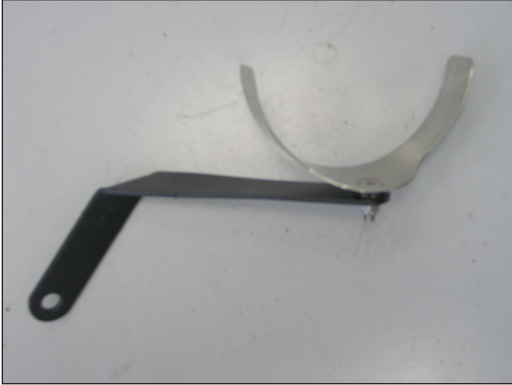

12. Install the supplied saddle clamp onto the tube mounting bracket (07160) using the provided hardware as shown.

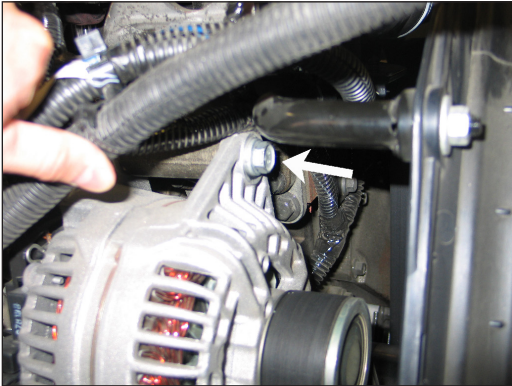

13. Remove the upper alternator mounting bolt shown.

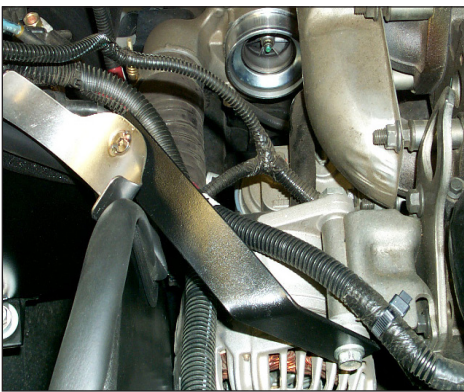

14. Install the tube mounting bracket assembly onto the alternator and secure with the factory bolt removed in the previous step.

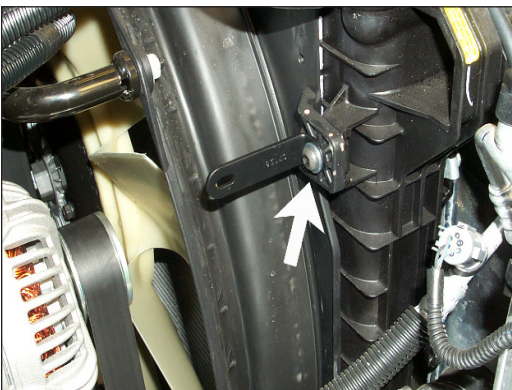

15. Remove the radiator fan shroud bolt. Then install the heat shield mounting bracket (07158) onto the fan shroud using the provided hardware as shown.

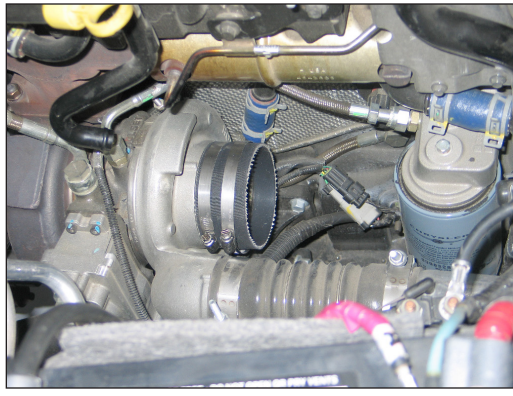

16. Install the provided silicone hose (08761) onto the turbo and secure with the provided hose clamp.

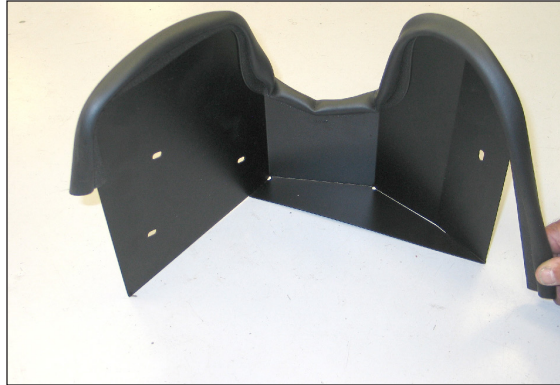

17. Install the provided edge trim onto the heat shield as shown.
NOTE: Some trimming of the edge trim will be necessary.

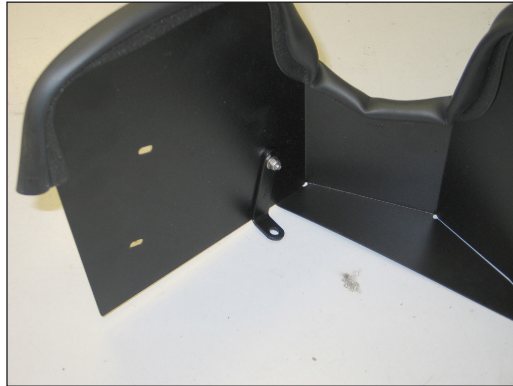

18. Install the heat shield mounting bracket (06723) onto the heat shield using the provided hardware.
NOTE: The bolt should be inserted from the back side through the heat shield and then through the bracket.



19. Install the provided heat shield mounting bracket (06722) onto the heat shield using the provided hardware.
NOTE: The bolts should be inserted from the back side through the heat shield and then through the bracket.



20. Attach the two provided inserted nuts to the heat shield using the provided hardware as shown.
NOTE: Do not tighten the mounting bolts at this time.

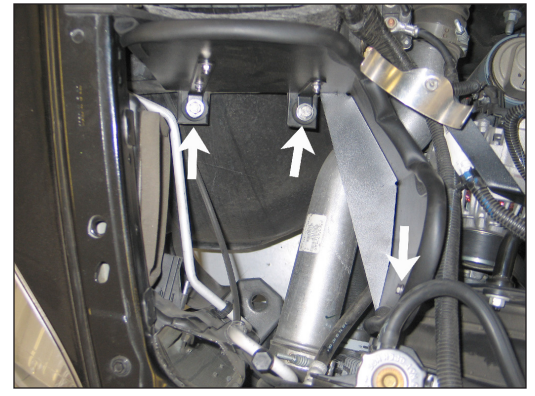

21. Install the heat shield assembly into the engine compartment as shown. The inserted nuts should be positioned into the air box mounting grommet holes and align the front mounting hole in the heat shield with bracket installed in step #15. Secure the heat shield with the provided hardware and the two inserted nuts.

NOTE: Be sure to place the provided spacer between the heat shield mounting bracket and the heat shield.



22. Remove the screws which secure the mass air sensor and inlet air temperature sensor and then remove the sensors as shown.

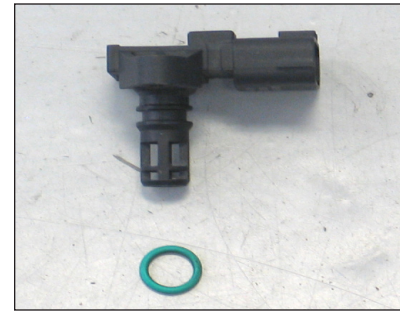

23. Remove the "O" ring from the air temperature sensor.

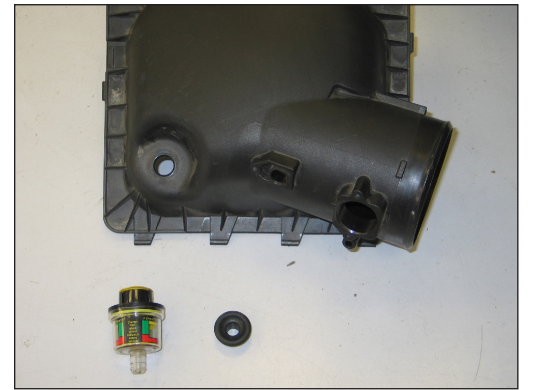

24. On vehicles equipped with filter minder, remove filter minder and grommet from the upper air box as shown.



25. Install the grommet and filter minder removed in step 24 into the K&N[®] air filter as shown. On vehicles not equipped with filter minder install the provided plug.



26. Install the provided 1/4" npt fitting into the intake tube as shown.

NOTE: Plastic NPT fittings are easy to cross thread. Install the vent fitting "hand" tight, then turn it two complete turns with a wrench.



27. Install the provided grommet into the intake tube as shown.



28. Install the air temperature sensor into the grommet and then secure the sensor with the provided bolt and spacer.

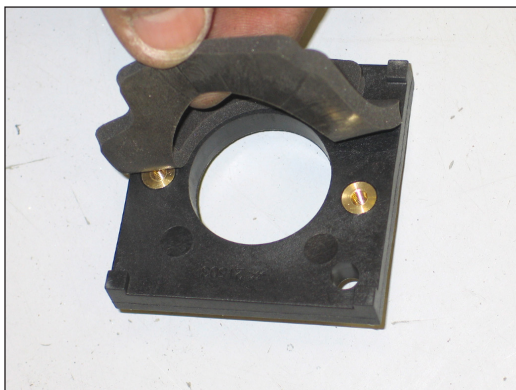

29. Apply the provided gasket onto the mass air sensor adapter as shown.



30. Install the mass [air sensor](#) into the adapter and secure with the provided hardware.



31. Install the mass air sensor assembly into the intake tube and secure with the provided hardware.

NOTE: The arrow on the top of the mass air sensor should be pointed in the direction of the intake air flow, towards the turbo inlet.



32. Install the K&N[®] Air Filter onto the intake tube and secure with the provided hose clamp.

NOTE: The filter is a tight fit, be sure the tube bead seats into the receiver groove in the filter.

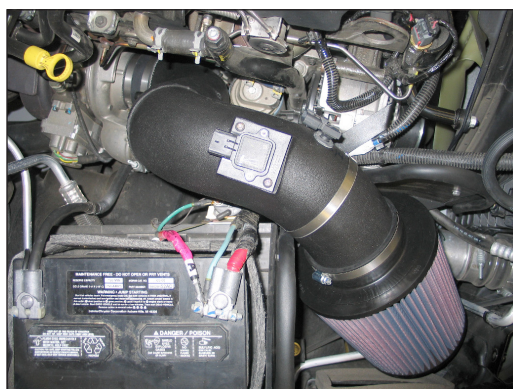

33. Install the intake tube and filter assembly, slide the intake tube into the silicone hose at the turbo and then align with the saddle bracket. Secure the assembly with the provided hose clamps.



34. Install the provided air injection hose onto the air injection tube and then connect the open end to the 1/4" npt fitting in the K&N[®] intake tube.

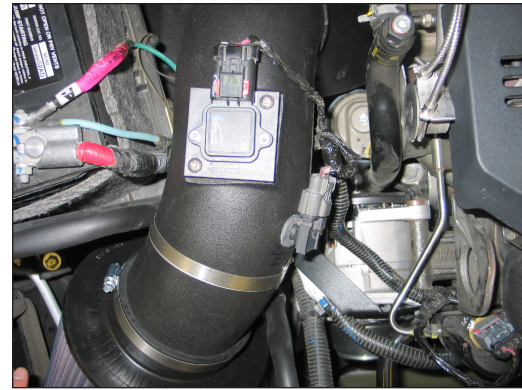

35. Reconnect the mass air sensor and inlet air temperature sensor electrical connections.



36. Reconnect the vehicles negative battery cable. Double check to make sure everything is tight and properly positioned before starting the vehicle.

37. The C.A.R.B. exemption sticker, (attached), must be visible under the hood so that an emissions inspector can see it when the vehicle is required to be tested for emissions. California requires testing every two years, other states may vary.

38. It will be necessary for all K&N[®] high flow intake system to be checked periodically for re-alignment, clearance, and tightening of all connections. Failure to follow the above instructions may void warranty.

ROAD TESTING:

1. Start the engine with the transmission in neutral or park, and the parking brake engaged. Listen for air leaks or odd noises. For air leaks, secure hoses and connections. For odd noises, find cause and repair before proceeding. This kit will function identically to the factory system except for being louder and much more responsive.

2. Test drive the vehicle. Listen for odd noises or rattles and fix as necessary.

3. If road test is fine, you can now enjoy the added power and performance from your kit.

4. K&N Engineering, Inc., suggest periodically checking the Air Filter element for excessive dirt and build-up. When the element becomes covered in dirt (or once a year), service it according to the instructions on the recharger service kit, part number 99-5000 or 99-5050.