



INSTALLATION INSTRUCTIONS

57-1552
DODGE / JEEP
2007-10 Caliber
L4-1.8 / 2.0L / 2.4L
2007-10 Compass
L4-2.4L
2007-10 Patriot
L4-2.0L / 2.4L

TOOLS NEEDED:

- Flat Blade Screwdriver
- Ratchet
- Extension
- 10mm Socket
- Pliers
- 5/8" Wrench

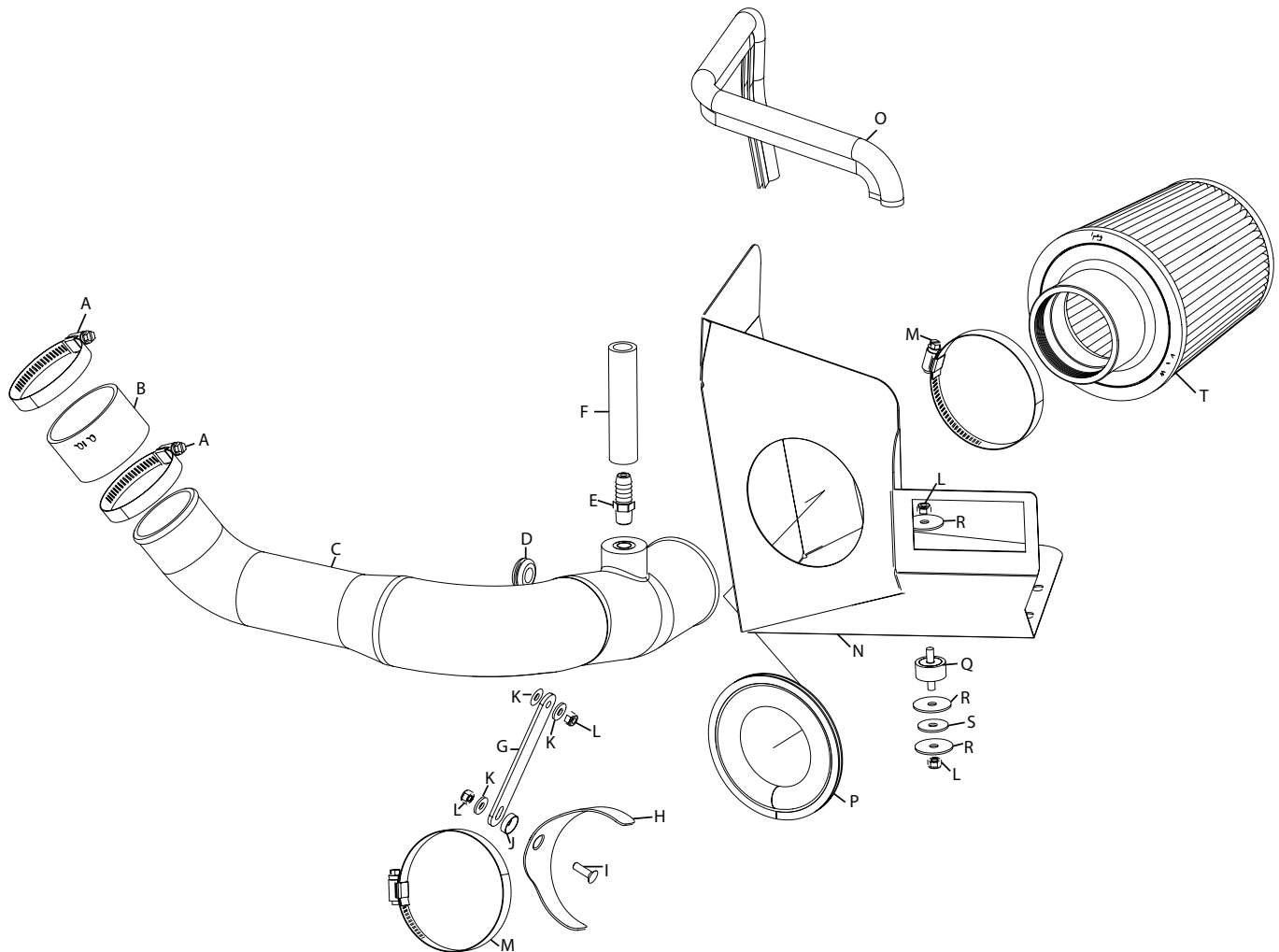

PARTS LIST:

Description	Qty.	Part #	Description	Qty.	Part #	Description	Qty.	Part #
A Hose Clamp #40	2	08554	H Bracket; Saddle, S/S	1	078855	O Edge Trim (23")	1	102495
B Hose; 2.63"ID X 1.75"L, Silicone	1	08108	I Bolt; 6mm-1.00 X 20mm F/H/A	1	08376	P Edge Trim (17")	1	102469
C Intake Tube	1	087206	J Washer; Conical, Nylon, Black	1	08180	Q Stud; M6-1.00 M/M, Rubber Mntd	1	07027
D Grommet; 1-1/16od, 1/2id, 3/8	1	080544	K Washer; 1/4"Id X 5/8"Od - Sae	3	08275	R Washer; 1.25d X .28 Hol Zn062	3	08151
E Vent; Strt 1/2" Hose, 1/4"Npt,	1	080022	L Nut; 6mm Nylock, Hexhead	4	07553	S Washer; 1" X .300 X .100 Rubber	1	21685
F Hose; 1/2"Id X4-1/2"L, Silicone	1	08485	M Hose Clamp #48	2	08601	T Air Filter	1	RU-4730
G Bracket; Mild Stl. Fb/Pc	1	26636	N Heat Shield	1	07637			

NOTE: FAILURE TO FOLLOW INSTALLATION INSTRUCTIONS AND NOT USING THE PROVIDED HARDWARE MAY DAMAGE THE INTAKE TUBE, THROTTLE BODY AND ENGINE.

TO START:

1. Turn off the ignition and disconnect the negative battery cable.
NOTE: Disconnecting the negative battery cable erases pre-programmed electronic memories. Write down all memory settings before disconnecting the negative battery cable. Some radios will require an anti-theft code to be entered after the battery is reconnected. The anti-theft code is typically supplied with your owner's manual. In the event your vehicles' anti-theft code cannot be recovered, contact an authorized dealership to obtain your vehicles anti-theft code.



2. Pull up firmly to dislodge the engine cover from the mounting grommets. Then remove the engine cover from the vehicle.

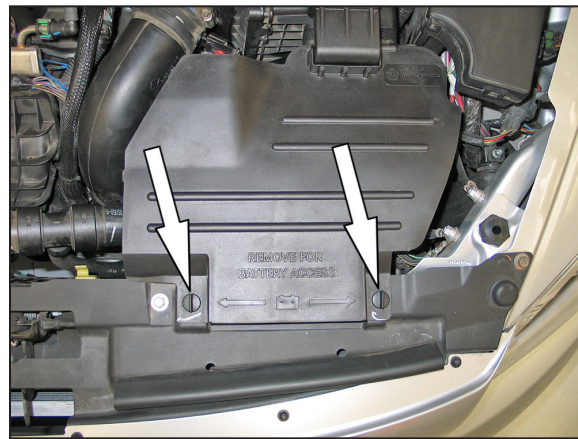

3. Rotate the fresh air tube fasteners counter clockwise to unlock them from the radiator core support.



4. Remove the fresh air duct from the stock air filter housing and radiator core support.



5. Depress the locking tab and disconnect the inlet air temperature sensor's electrical connection.

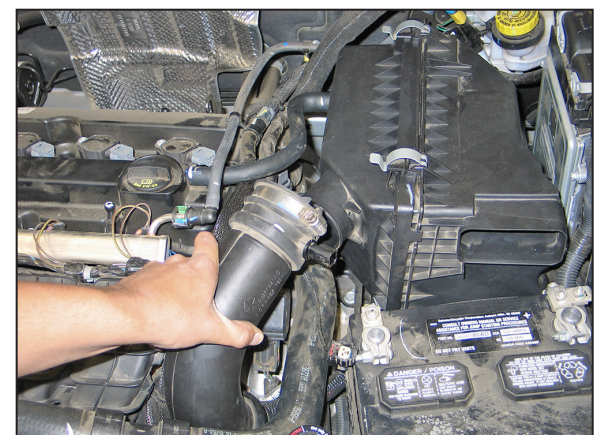

6. Loosen the hose clamp that secures the stock intake tube to the factory air filter housing.

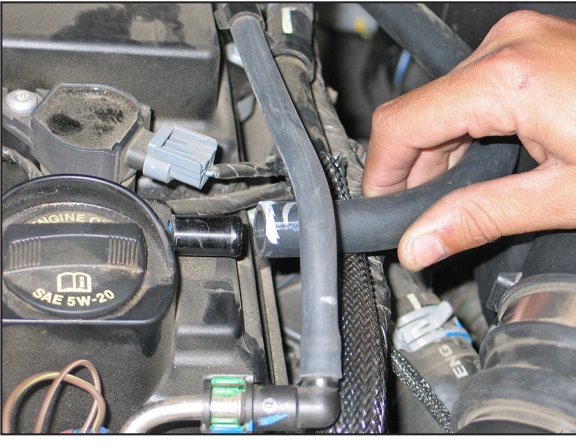

7. Disconnect the crankcase vent hose from valve cover.

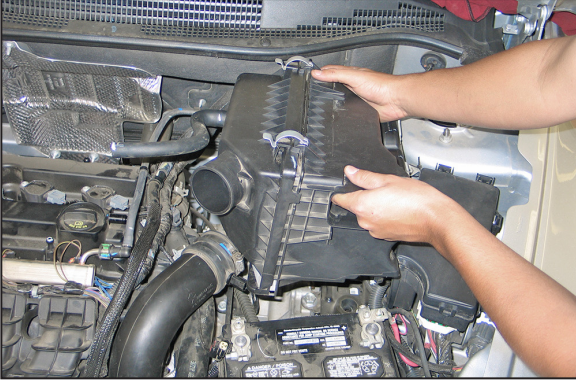

8. Pull up firmly to dislodge the airbox from the mounting grommets and then remove the airbox from the vehicle.

NOTE: K&N Engineering, Inc., recommends that customers do not discard factory air intake.

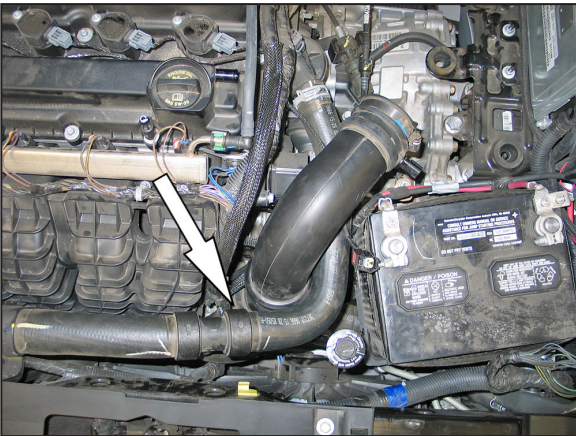

9. Loosen the hose clamp at the lower end of the stock intake tube from the vehicle.

NOTE: Be sure the engine is cool before attempting to loosen the intake tube hose clamp to prevent being burnt by hot components.



10. Remove the stock intake tube from the vehicle.
NOTE: Be sure to unclip the wiring harness from the intake tube as you remove the tube from the vehicle.



11. Remove the airbox mounting grommet shown.

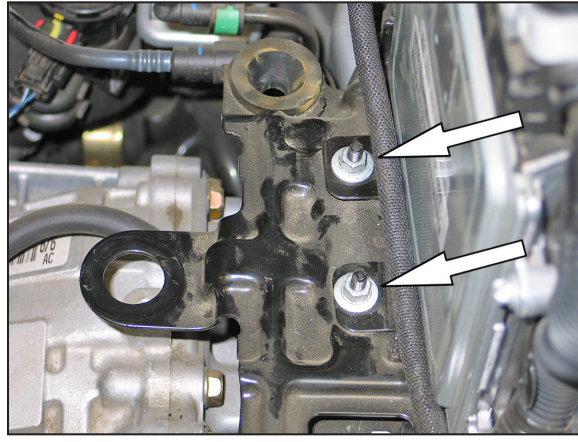

12. Remove the two airbox mounting nuts shown.
NOTE: These nuts will be reused in a later step.

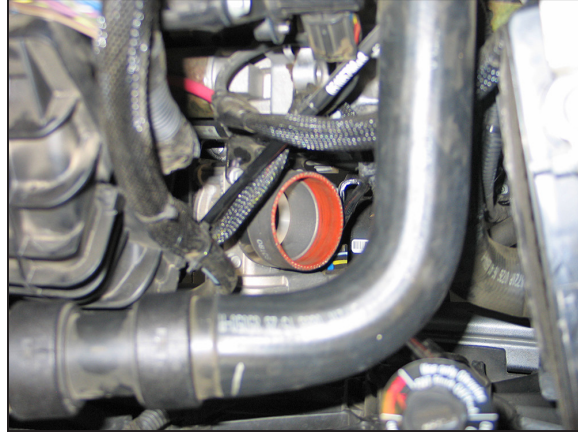

13. Install the silicone hose (08108) onto throttle body and secure with the provided hose clamp.



14. Install the supplied grommet into the intake tube as shown.



15. Remove the air temperature sensor from the factory intake tube as shown.
NOTE: Be careful removing the air temperature sensor as it is very fragile.



16. Install the air temperature sensor into the grommet.
NOTE: Be careful installing the air temperature sensor as it is very fragile.



17. Install the supplied 1/4" npt vent fitting into the threaded boss in the K&N® intake tube as shown.
NOTE: Plastic NPT fittings are easy to cross thread. Install the vent fitting "hand" tight, then turn it two complete turns with a wrench.



18. Install saddle clamp onto the supplied bracket (26636) with the hardware provided.

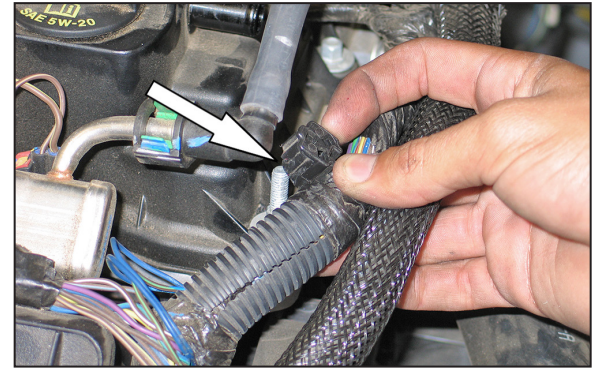

19. Unhook the wiring harness from the corner valve cover bolt as shown.

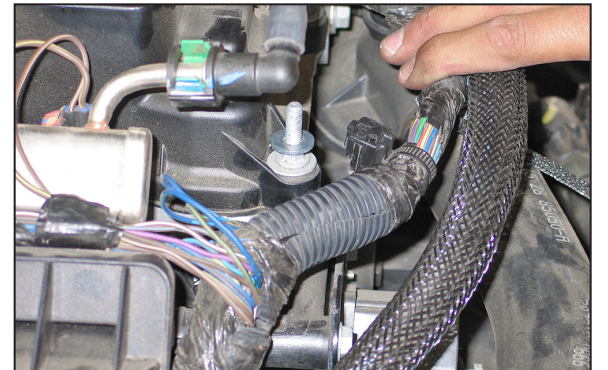

20. Place one washer onto the valve cover stud as shown.

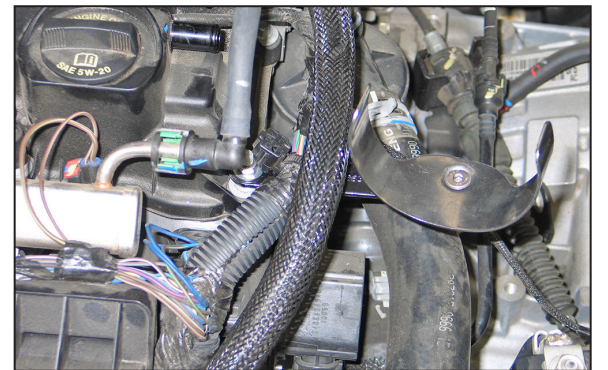

21. Install the tube mounting bracket assembly onto the valve cover stud and secure with the provided hardware.
NOTE: Do not completely tighten at this time.

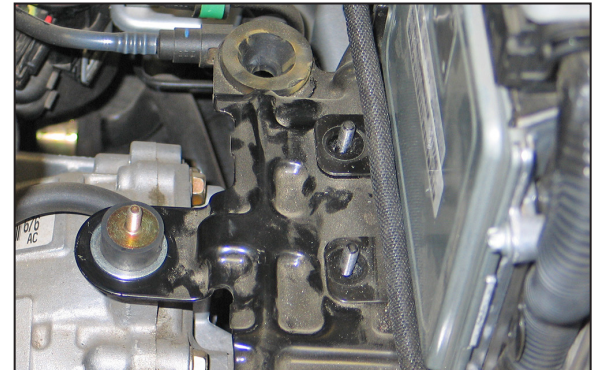

22. Install rubber mounted stud using the large fender washers provided.

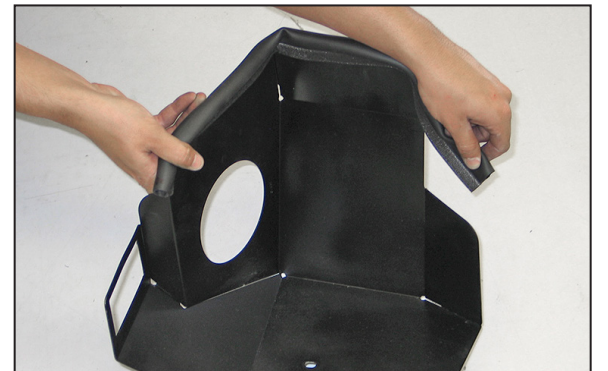

23. Install the long edge trim along the top of the heat shield as shown.
NOTE: Some trimming of the edge trim may be necessary.

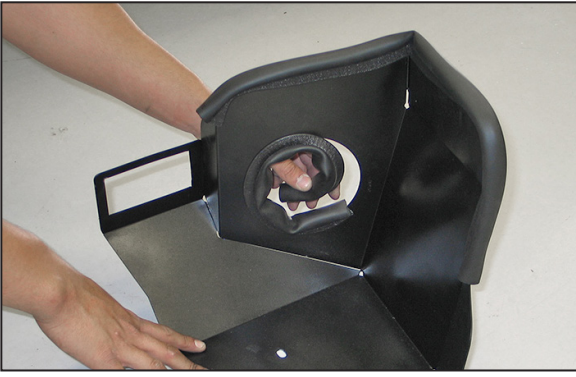

24. Install the short edge trim into the tube pass through hole as shown.

NOTE: Some trimming of the edge trim may be necessary.

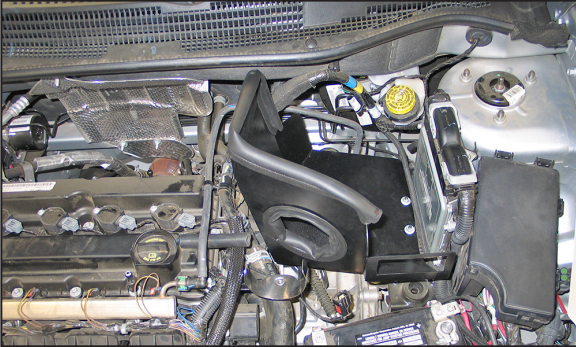

25. Install heat shield onto the mounting studs and secure with the two nuts removed in step #12 and the provided hardware.



26. Install the K&N® intake tube into the silicone hose and align onto the saddle clamp. Then secure with the provided hose clamps. Tighten bolts in #21.

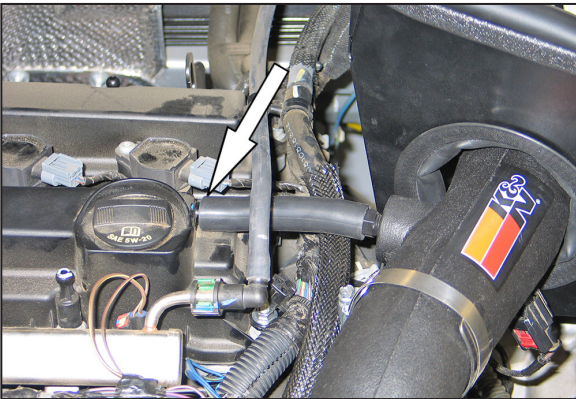

27. Install the provided crankcase vent hose onto the valve cover. Then onto the fitting installed into the K&N® intake tube.

NOTE: Some trimming of the vent hose may be necessary.



28. Reconnect the air temperature sensor electrical connection.



29. Install the K&N® air filter and secure with the provided hose clamp.

NOTE: Drycharger® air filter wrap; part # RX-4730DK is available to purchase separately.

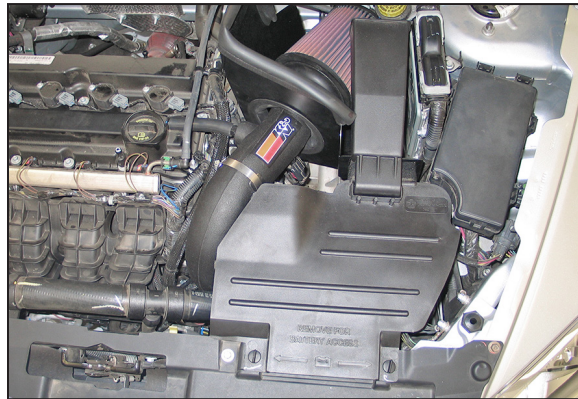

30. Install the fresh air duct into the heat shield and onto the core support. Then secure with the factory quarter turn fasteners.



31. Reinstall the engine cover onto the engine.



32. Reconnect the vehicle's negative battery cable. Double check to make sure everything is tight and properly positioned before starting the vehicle.

33. The C.A.R.B. exemption sticker, (attached), must be visible under the hood so that an emissions inspector can see it when the vehicle is required to be tested for emissions. California requires testing every two years, other states may vary.

34. It will be necessary for all K&N® high flow intake systems to be checked periodically for realignment, clearance and tightening of all connections. Failure to follow the above instructions or proper maintenance may void warranty.

ROAD TESTING:

1. Start the engine with the transmission in neutral or park, and the parking brake engaged. Listen for air leaks or odd noises. For air leaks secure hoses and connections. For odd noises, find cause and repair before proceeding. This kit will function identically to the factory system except for being louder and much more responsive.

2. Test drive the vehicle. Listen for odd noises or rattles and fix as necessary.

3. If road test is fine, you can now enjoy the added power and performance from your kit.

4. K&N Engineering, Inc., requires cleaning the intake system's air filter element every 100,000 miles. When used in dusty or off-road environments, our filters will require cleaning more often. We recommend that you visually inspect your filter once every 25,000 miles to determine if the screen is still visible. When the screen is no longer visible some place on the filter element, it is time to clean it. To clean and re-oil, purchase our filter Recharger® service kit, part number 99-5050 or 99-5000 and follow the easy instructions.