



INSTALLATION INSTRUCTIONS

57-1537
DODGE
2002-10 RAM 1500
V6-3.7L

NOTE: This kit was not designed to fit vehicles with a body lift.

TOOLS NEEDED:

- Flat Blade Screwdriver
- 7/16" Socket
- 7/16" Wrench
- 4mm Allen
- 10MM Socket
- 13MM Socket
- 10MM Wrench
- 17MM Wrench
- Extension
- Ratchet

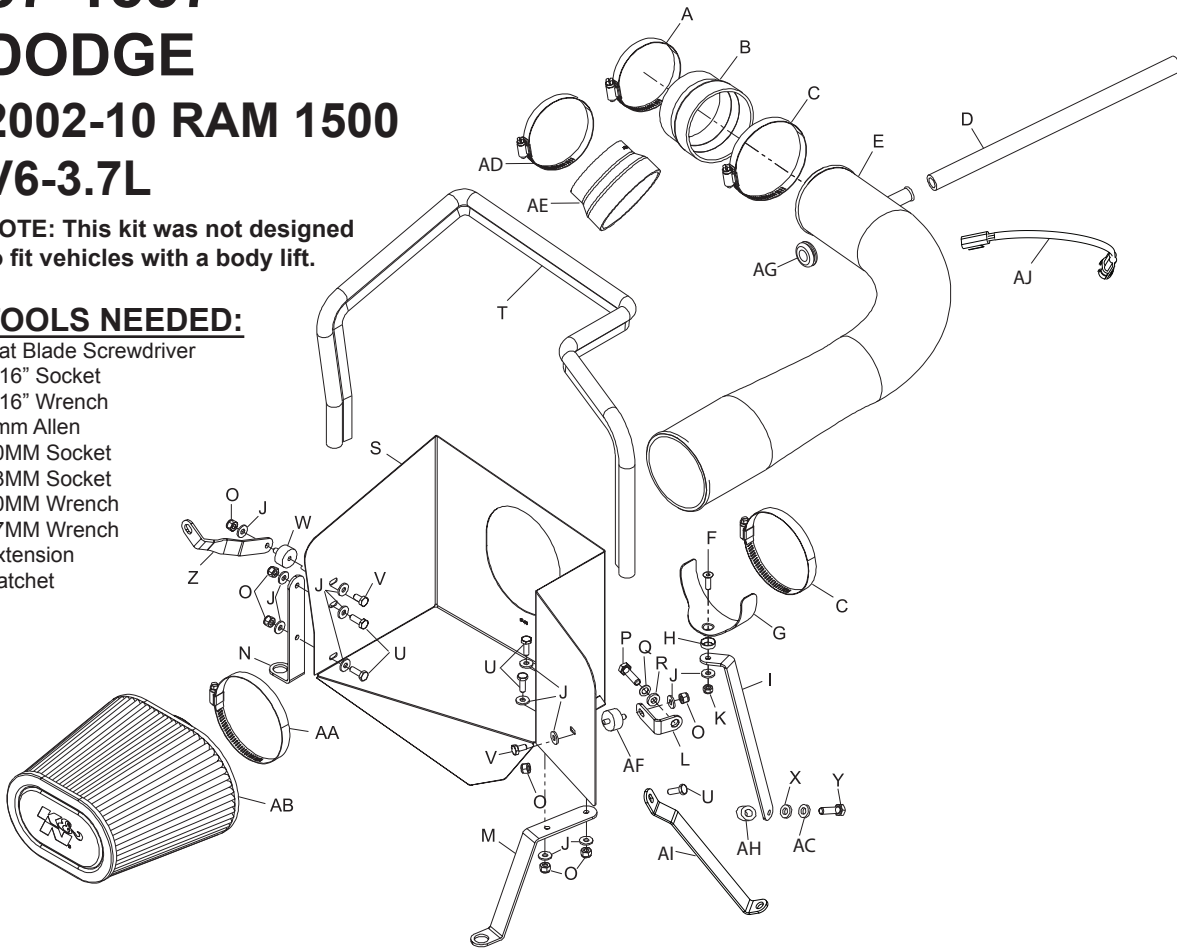

PARTS LIST:

Description	Qty.	Part #
A	1	08610
B	1	08051
C	2	08620
D	1	08402
E	1	087111
F	1	08376
G	1	078855
H	1	08180
I	1	07189
J	13	08275
K	1	07553
L	1	26607
M	1	07149
N	1	07148
O	7	07517
P	1	07821
Q	1	08239
R	1	08276
S	1	07478
T	1	102487
U	5	08386
V	2	08317
W	1	08011
X	1	08134
Y	1	07702
Z	1	07150
AA	1	08648
AB	1	Rf-1040
AC	1	08175
AD	1	08577
AE	1	084093
AF	1	08005
AG	1	080544
AH	1	21715
AI	1	083103
AJ	1	21680

NOTE: FAILURE TO FOLLOW INSTALLATION INSTRUCTIONS AND NOT USING THE PROVIDED HARDWARE MAY DAMAGE THE INTAKE TUBE, THROTTLE BODY AND ENGINE.

TO START:

1. Turn off the ignition and disconnect the negative battery cable.

NOTE: Disconnecting the negative battery cable erases pre-programmed electronic memories. Write down all memory settings before disconnecting the negative battery cable. Some radios will require an anti-theft code to be entered after the battery is reconnected. The anti-theft code is typically supplied with your owner's manual. In the event your vehicles' anti-theft code cannot be recovered, contact an authorized dealership to obtain your vehicles anti-theft code.



2. Loosen the hose clamp that connects the intake tube to the resonator box then remove the intake tube.

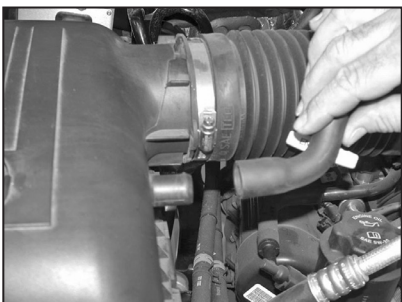

2a. On vehicles equipped, disconnect the crankcase vent from the airbox as shown.



3. Lift firmly to release the airbox from the mounting studs, then remove completely.
NOTE: K&N Engineering, Inc., recommends that customers do not discard factory air intake.



4. On vehicles equipped with a air temperature sensor in the resonator box, depress the locking tab and separate the electrical connection.

NOTE: On 2008 and later model year vehicles see step 4a.

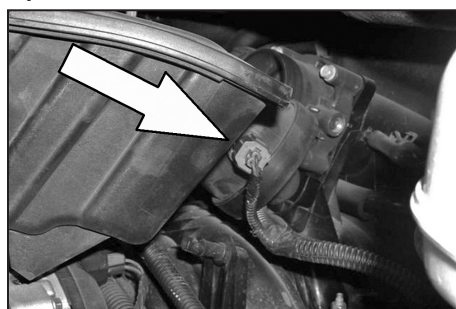

4a. On 2008 and later model year vehicles the inlet air temperature sensor is located on the driver's side of the vehicle next to the throttle body.



5. On 2007 and earlier model vehicles, remove the two 10mm bolts that retain the resonator box onto the engine



6. Pull up firmly to release the resonator from the engine.



7. On 2007 and earlier model vehicles, disconnect the crankcase vent hose from resonator box as shown, then remove resonator box from vehicle.



8. On 2007 and earlier model vehicles, remove crankcase vent hose from tee as shown.



9. Loosen hose clamp that retains the rubber hose to the throttle body, then remove as shown.

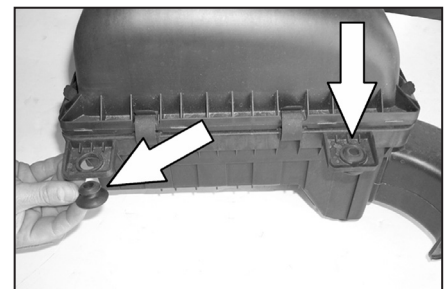

10. Remove the two rubber bushings from the factory airbox as shown.

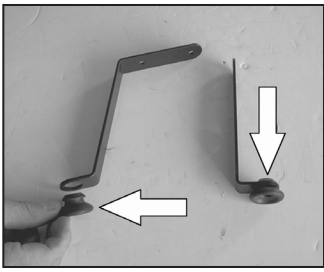

11. Install the two rubber bushings that were removed in the previous step into the provided brackets as shown.

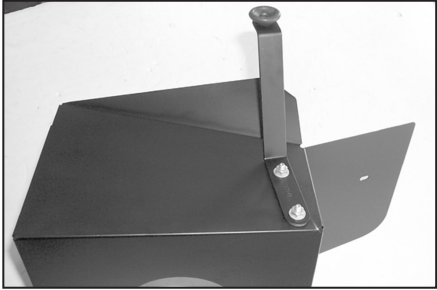

12. Install the large "Z" bracket onto the heat shield with the provided hardware. Do not tighten completely at this time.

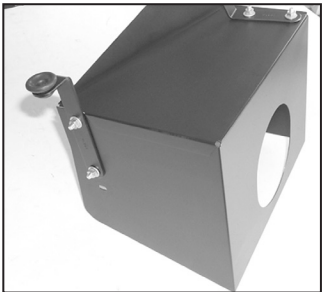

13. Install the "L" bracket onto the heat shield with the provided hardware. Do not tighten completely at this time.



14. Install the rubber mounted stud into the provided bracket as shown.



15. Install the provided edge trim onto the heat shield. Trim if necessary.

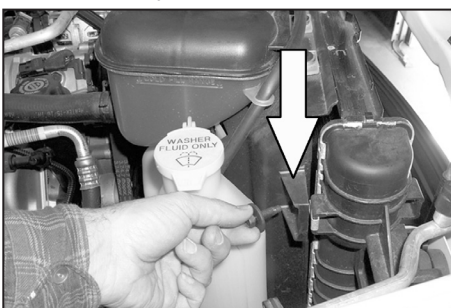

16. Remove the 13mm bolt from the upper fan shroud as shown.



16A. On 2008 and later model year vehicles: Install the provided rubber mounted stud onto the heat shield mounting bracket (26607) as shown.
NOTE: The rubber mounted stud will be attached to the heat shield when installed.



16B. Install the "L" bracket (26607) onto the fan shroud with the provided 8mm bolt and washers.

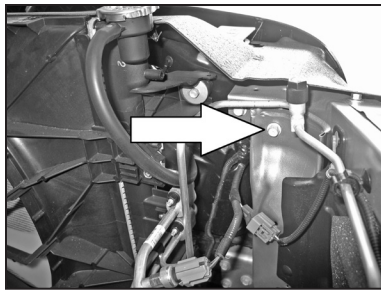

17. On 2009 and later model vehicles, remove the bolt shown from the radiator core support.

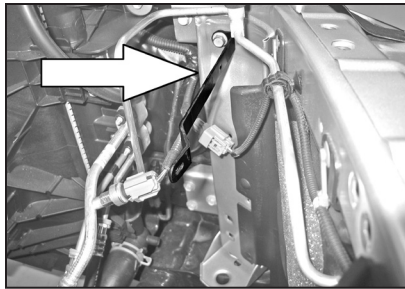

17a. On 2009 and later model vehicles, install the provided heat shield mounting bracket onto the radiator core support using the bolt removed in the previous step.

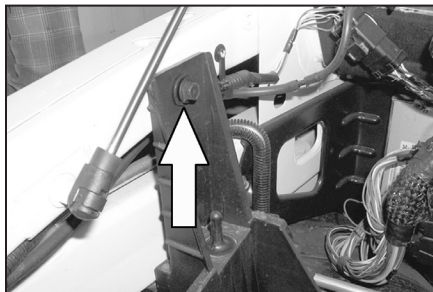

18. Remove the 8mm bolt that retains the airbox mount.

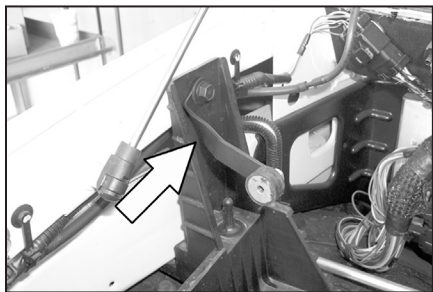

19. Install the twisted "L" bracket with the bolt that was removed in step 18. Do not tighten bolt completely.



20. Assemble the saddle bracket assembly as shown.



21. On 2007 and earlier model vehicles, install saddle bracket assembly onto engine using the provided hardware as shown.

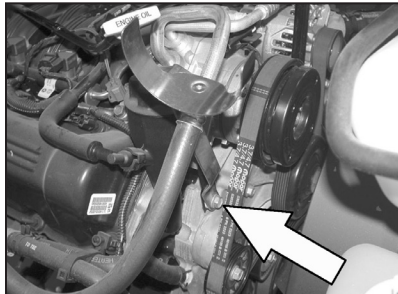

21A. On vehicles equipped with a bracket between the belt tensioner and the a/c compressor, install the provided spacer between the supplied bracket and factory bracket.



22. Install the heat shield onto the factory airbox studs then mount to the previously installed brackets.

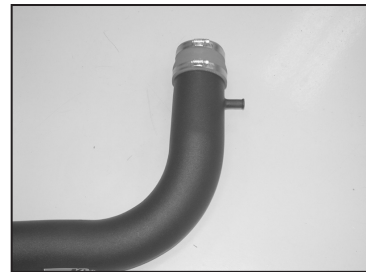

23. Install the provided silicone hose (08051) onto the K&N® intake tube with the provided hose clamp as shown.

NOTE: On 2008 and later model vehicles use hose #084093 provided.



24. Install the intake tube onto the throttle body and saddle clamp and secure with the provided hose clamps as shown.



25. On models that come equipped with temp sensors, remove the air temp sensor from the resonator box as shown.

NOTE: Take care removing the air temperature sensor as it is very fragile.



25a. On vehicles equipped with an air temperature sensor, hold up the air temperature sensor wiring harness to the intake tube and mark the intake tube for drill point.

NOTE: On 2008 and later model year vehicles the temperature sensor is located on the driver's side of the throttle body.



25b. On models that come equipped with temp sensors, drill a 7/8" hole in the K&N® intake tube at the drill point.



25c. Install the provided grommet into the intake tube as shown.



25d. Remove the O-ring from the air temp. sensor as shown.



25e. Install the air temp sensor into the K&N® intake tube as shown.

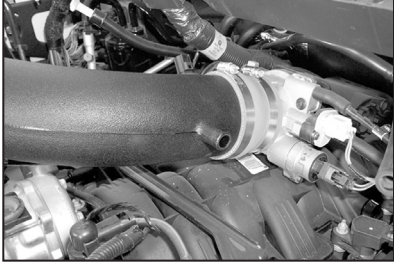

26. Install the [intake tube](#) onto the throttle body with the provided hose clamp.

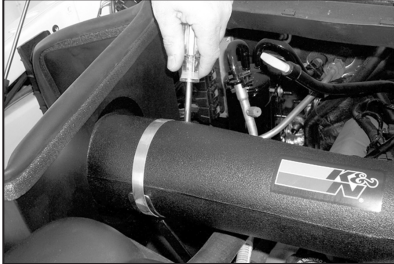

27. Using the provided hose clamp, secure the K&N® intake tube to the saddle bracket assembly as shown.



28. On models equipped with a air temp sensor, reconnect the electrical connection as shown.
NOTE: Due to manufacturing tolerances, it may be necessary to use the provided extension harness to connect the inlet air temperature sensor electrical connection.

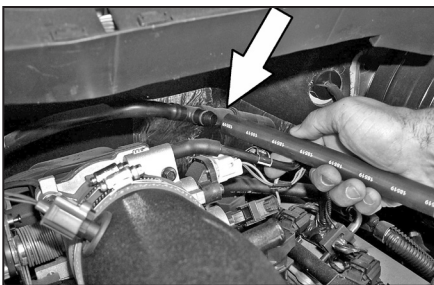

29. On models that the crankcase vent hose is connected to the "T" on the drivers side of the engine, remove the factory vent hose from the "T" fitting as shown.



29A. On 2008 and later model year vehicles remove the crankcase vent tube from the passenger side valve cover. Then remove the rubber elbow from the tube, and install the provided straight silicone hose. Then reinstall the crankcase vent tube so that it runs behind the throttle body .

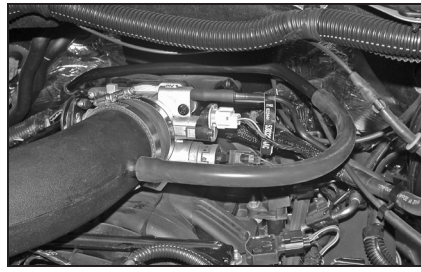

30. Connect the modified crankcase vent hose to the K&N® intake tube as shown.



31. On models that the crankcase vent hose is connected to the "T" on the passengers side of the engine, remove the complete vent tube assembly from the rubber fittings in each valve cover as shown.

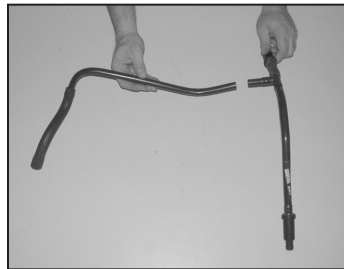

32. Cut the crankcase vent tube 1" from the "T" fitting as shown.

NOTE: Cut the tube that was originally fastened to the airbox

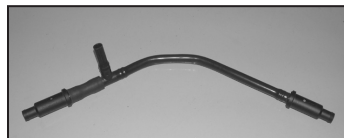

33. Rotate the long side of the vent tube assembly 180° as shown.

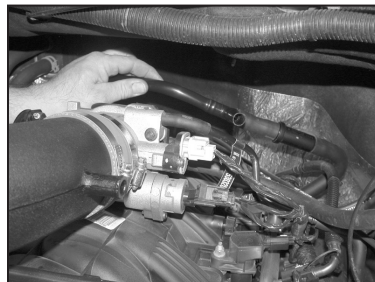

34. Reinstall the vent tube assembly into the rubber fittings in each valve cover so that the "T" fitting is now on the drivers side of the engine facing forward.

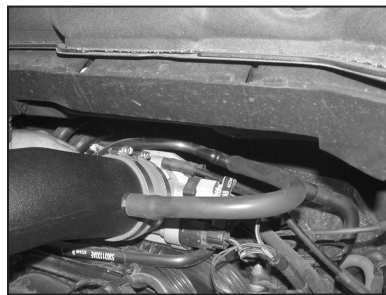

35. Connect the provided vent hose onto the "T" fitting, then connect the other end onto the K&N® intake tube.

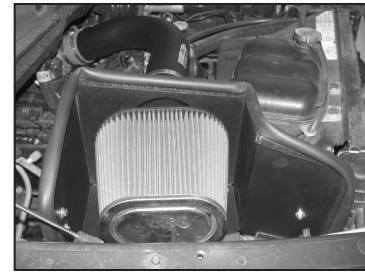

36. Install the K&N® air filter onto the K&N® intake tube as shown and secure with the hose clamp.

NOTE: Drycharger® air filter wrap; part number RF-1034DK is available to purchase separately.



37. Align the heat shield for best clearance then tighten all the brackets.



38. Reconnect the vehicle's negative battery cable. Double check to make sure everything is tight and properly positioned before starting the vehicle.

39. The C.A.R.B. exemption sticker, (attached), must be visible under the hood, so the emissions inspector can see it when the vehicle is required to be tested for emissions. California requires testing every two years, other states may vary.

40. It will be necessary for all K&N® high flow intake systems to be checked periodically for realignment, clearance and tightening of all connections. Failure to follow the above instructions or proper maintenance may void warranty.

ROAD TESTING:

1. Start the engine with the transmission in neutral or park, and the parking brake engaged. Listen for air leaks or odd noises. For air leaks secure hoses and connections. For odd noises, find cause and repair before proceeding. This kit will function identically to the factory system except for being louder and much more responsive.
2. Test drive the vehicle. Listen for odd noises or rattles and fix as necessary.
3. If road test is fine, you can now enjoy the added power and performance from your kit.
4. K&N Engineering, Inc., suggests checking the air filter element periodically for excessive dirt build-up. When the element becomes covered in dirt (or once a year), service it according to the instructions on the Recharger® service kit, part number 99-5050 or 99-5000.