



INSTALLATION INSTRUCTIONS

57-1521 JEEP 1991-95 Wrangler L6-4.0L

NOTE: This kit was not designed to fit vehicles with a body lift.

TOOLS NEEDED:

Flat blade screwdriver
4mm allen hex wrench
3/8" drive ratchet
6" extension
1/2" socket
7/16" socket
13mm wrench
10mm wrench
7/16" wrench
Drill
1/4" drill bit

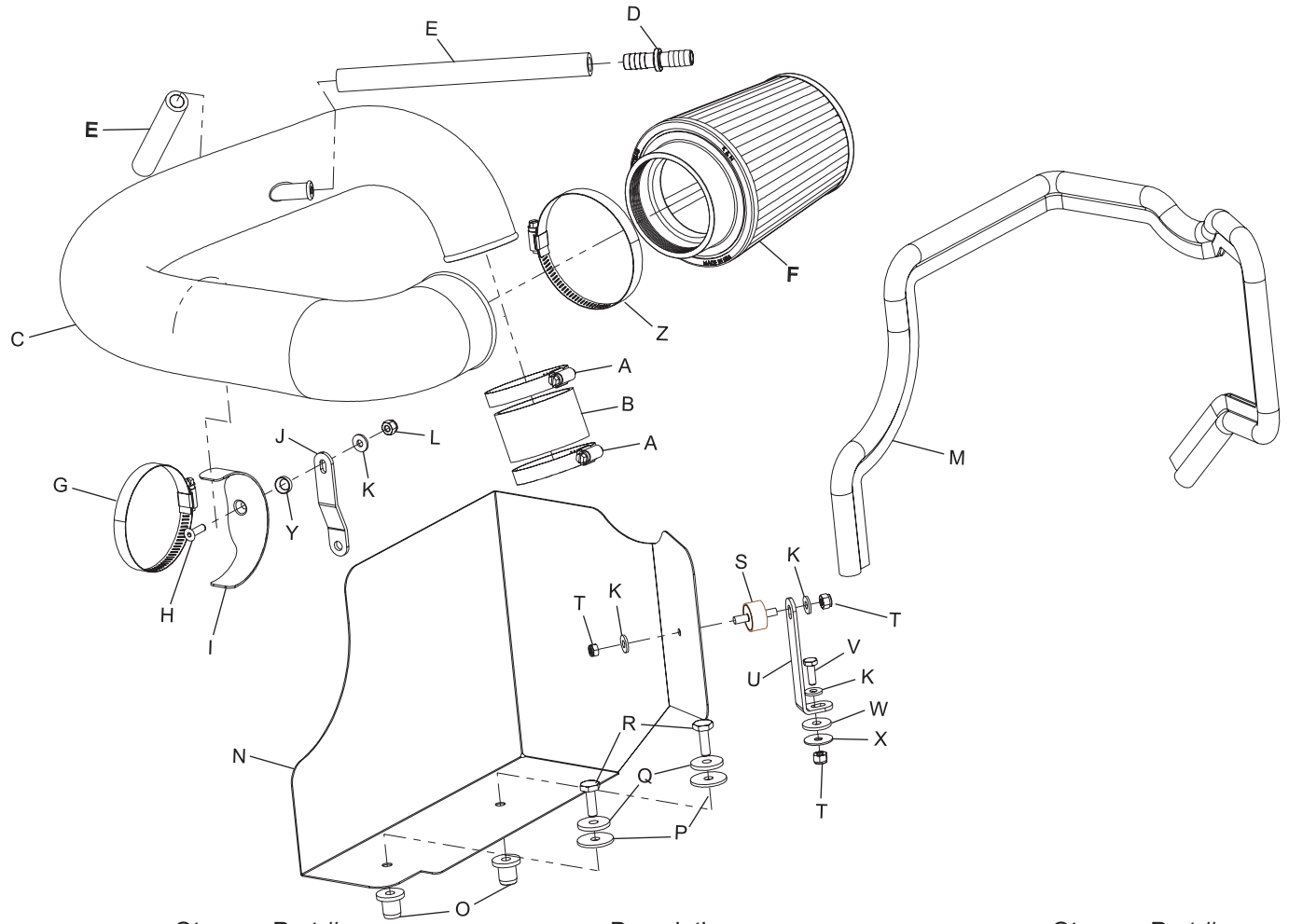

PARTS LIST:

Description	Qty.	Part #	Description	Qty.	Part #
A Hose clamp #40	2	08554	N Heat shield	1	07463
B 2.63id x 1.75"L, silicone hose	1	08108	O Rubber inserts	2	088002
C K&N intake tube	1	087045	P Rubber fender washer	2	21708
D Hose mender	1	08686	Q Fender washer	2	08130
E 1/2" id x 14" L silicone hose	1	08402	R Bolt, 5/16" - 18x1" L ss	2	07777
F Air Filter	1	RC-4630	S Rubber stud	1	08005
G Hose clamp #52	1	08610	T Nut, 1/4 x 20 nylock	3	07517
H Bolt 6mm-1.00x20m f/h/a ss	1	08376	U "L" bracket	1	070952
I Saddle bracket	1	078855	V Bolt, 1/4-20 x 3/4	1	08386
J "Z" bracket	1	26545	W Rubber fender washer	1	21685
K Washer, 1/4" id x 5/8" od sae	4	08275	X Fender washer	1	08160
L Nut, 6mm nylock	1	07553	Y Washer, conical, nylon, black	1	08180
M Trim seal, 46"L	1	102487	Z Hose clamp #60	1	08624

NOTE: FAILURE TO FOLLOW INSTALLATION INSTRUCTIONS AND NOT USING THE PROVIDED HARDWARE MAY DAMAGE THE INTAKE TUBE, THROTTLE BODY AND ENGINE.

TO START:

1. Turn off the ignition and disconnect the negative battery cable.

NOTE: Disconnecting the negative battery cable erases pre-programmed electronic memories. Write down all memory settings before disconnecting the negative battery cable. Some radios will require an anti-theft code to be entered after the battery is reconnected. The anti-theft code is typically supplied with your owner's manual. In the event your vehicles' anti-theft code cannot be recovered, contact an authorized dealership to obtain your vehicles anti-theft code.

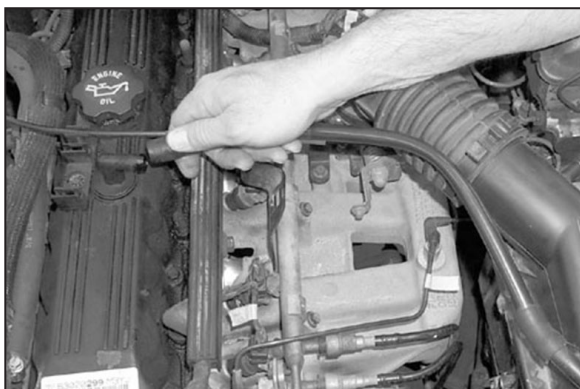

2. Disconnect the crank case vent hose.



3. Remove the EVAP canister vent line from the air cleaner lid

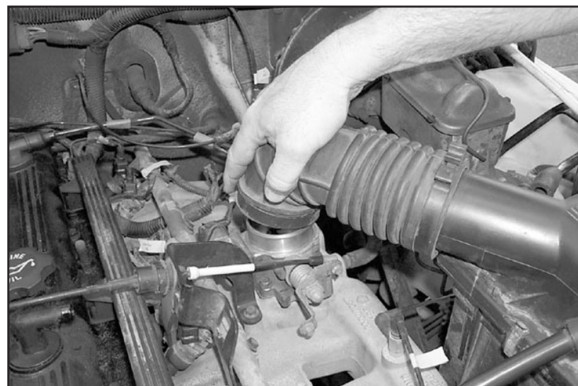

4. Loosen the hose clamp at the throttle body, then detach the stock intake tube from the throttle body as shown.



5. Unclip the three lower air cleaner retaining clamps, then remove the upper air cleaner assembly as shown.

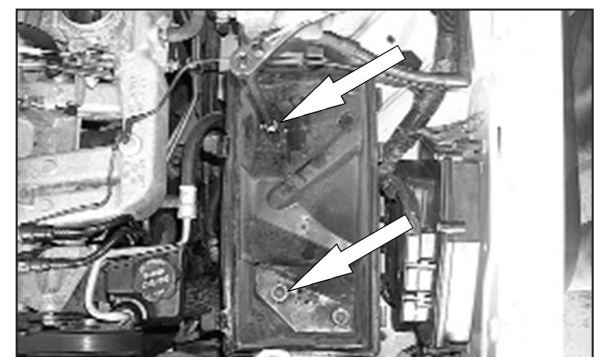

6. Loosen and remove the two bolts that secure the lower air cleaner assembly, then remove lower airbox from vehicle.

NOTE: K&N Engineering, Inc., recommends that customers do not discard factory air intake

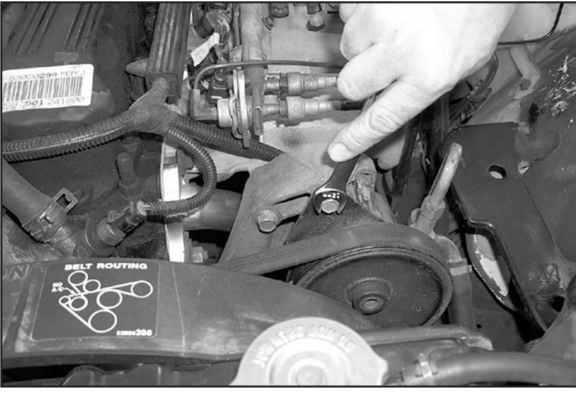

7. Remove the upper power steering pivot bolt as shown



8. Using the provided hardware assemble the saddle bracket assembly as shown.

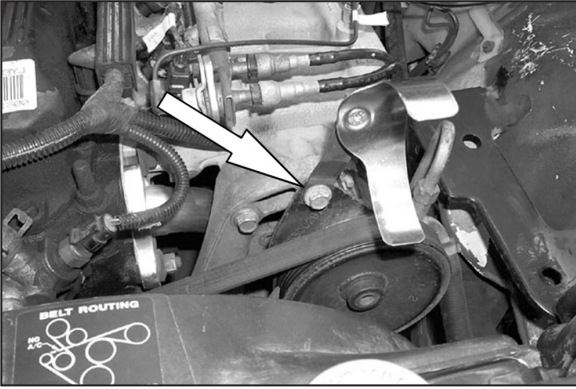

9. Using the bolt removed in step 7, secure the saddle bracket assembly to the upper power steering pivot as shown, but do not tighten completely at this time.

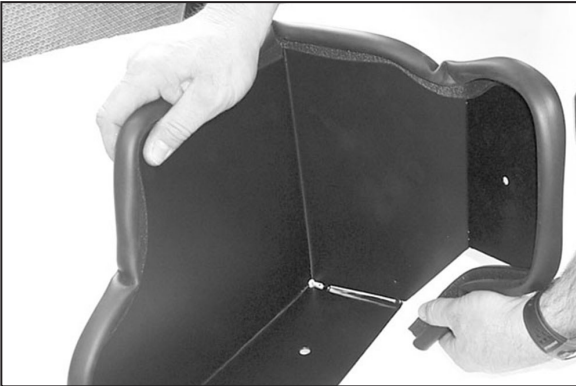

10. Apply the provided trim seal to the heat shield as shown and trim if necessary.

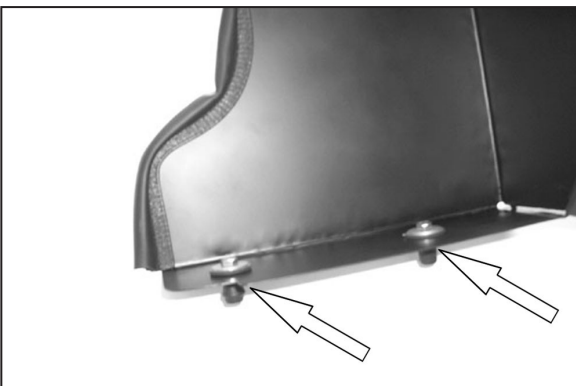

11. Secure the rubber mounting inserts to the holes on the heat shield with the provided bolts and washer. But do not tighten.

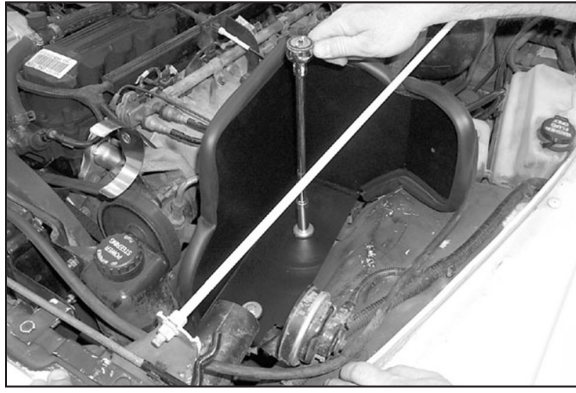

12. Install the heat shield and insert the rubber mounting inserts into the stock air cleaner locating holes and tighten as shown.

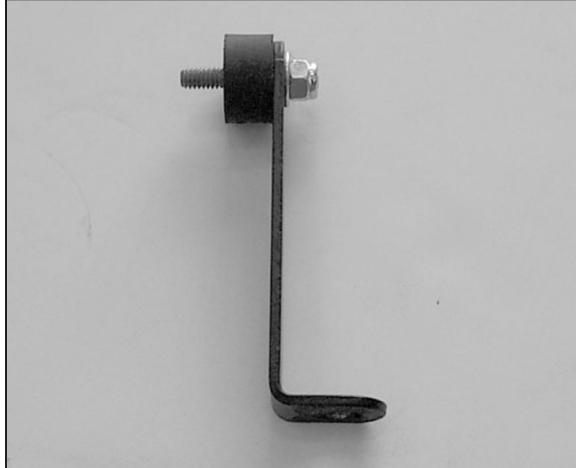

13. Assemble the "L" bracket and the rubber mounted stud using the provided hardware as shown.



14. Install the bracket onto the K&N® heat shield and line up the bracket with the inner fender then mark the hole and drill a 1/4" hole.

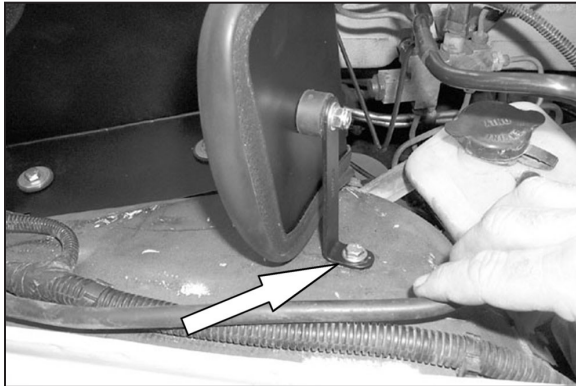

15. Secure the "L" bracket to the fender using the provided hardware as shown.



16. Install the provided silicone hose and hose clamps onto the throttle body as shown.

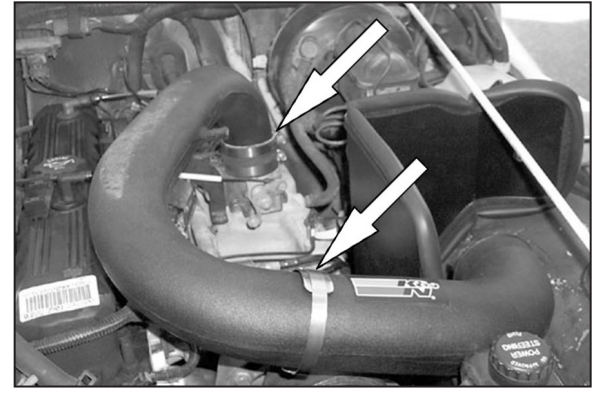

17. Install the K&N® intake tube into the silicone hose and line up the other end of the tube with the saddle bracket, then secure the tube to the throttle body and the saddle bracket with the provided hose clamp

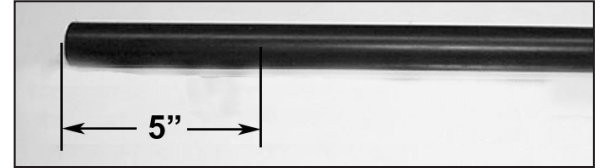

18. With supplied silicone hose, make a mark at 5 inches then cut.



19. Install the 5 inch hose onto the crankcase vent, then connect the other end to the vent on the K&N® intake tube as shown

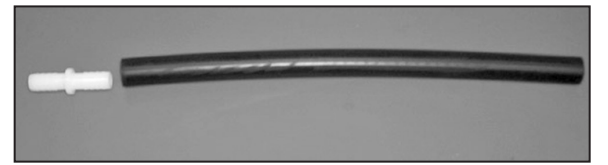

20. Assemble the remaining silicone hose and hose mender as shown.

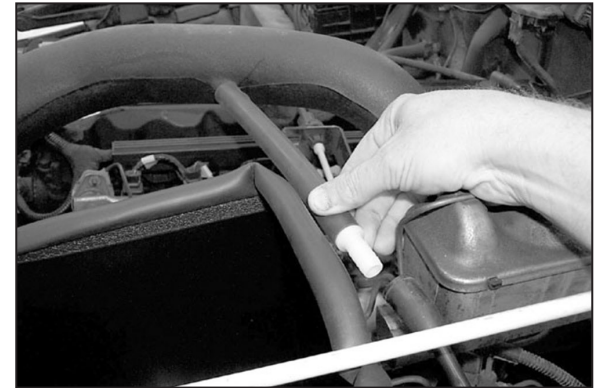

21. Connect the hose to the vent on the K&N® intake tube, then, connect the other end to the EVAP canister vent line as shown.

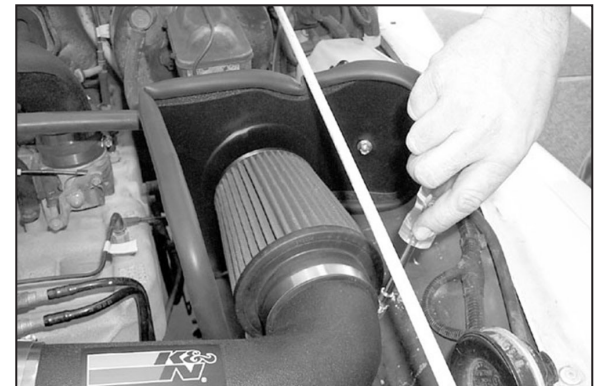

22. Install the air filter onto the K&N® intake tube and secure with the provided hose clamp as shown
NOTE: Drycharger® air filter wrap; part # RC-4630DK is available to purchase separately.



23. Reconnect the vehicle's negative battery cable. Double check to make sure everything is tight and properly positioned before starting the vehicle.

24. The C.A.R.B. exemption sticker, (attached), must be visible under the hood so that an emissions inspector can see it when the vehicle is required to be tested for emissions. California requires testing every two years, other states may vary.

25. It will be necessary for all K&N® high flow intake systems to be checked periodically for realignment, clearance and tightening of all connections. Failure to follow the above instructions or proper maintenance may void warranty.

ROAD TESTING:

1. Start the engine with the transmission in neutral or park, and the parking brake engaged. Listen for air leaks or odd noises. For air leaks secure hoses and connections. For odd noises, find cause and repair before proceeding. This kit will function identically to the factory system except for being louder and much more responsive.

2. Test drive the vehicle. Listen for odd noises or rattles and fix as necessary.

3. If road test is fine, you can now enjoy the added power and performance from your kit.

4. K&N Engineering, Inc., requires cleaning the intake system's air filter element every 100,000 miles. When used in dusty or off-road environments, our filters will require cleaning more often. We recommend that you visually inspect your filter once every 25,000 miles to determine if the screen is still visible. When the screen is no longer visible some place on the filter element, it is time to clean it. To clean and re-oil, purchase our filter Recharger® service kit, part number 99-5050 or 99-5000 and follow the easy instructions.