



INSTALLATION INSTRUCTIONS

57-1001

BMW 3 SERIES (E46)

2001-05 330CI, I

2002-05 330XI

2000 330xi

L6-3.0L

TOOLS NEEDED:

- Flat Blade Screwdriver
- Ratchet
- Extension
- 10mm Socket
- 10mm Wrench
- 4mm Allen

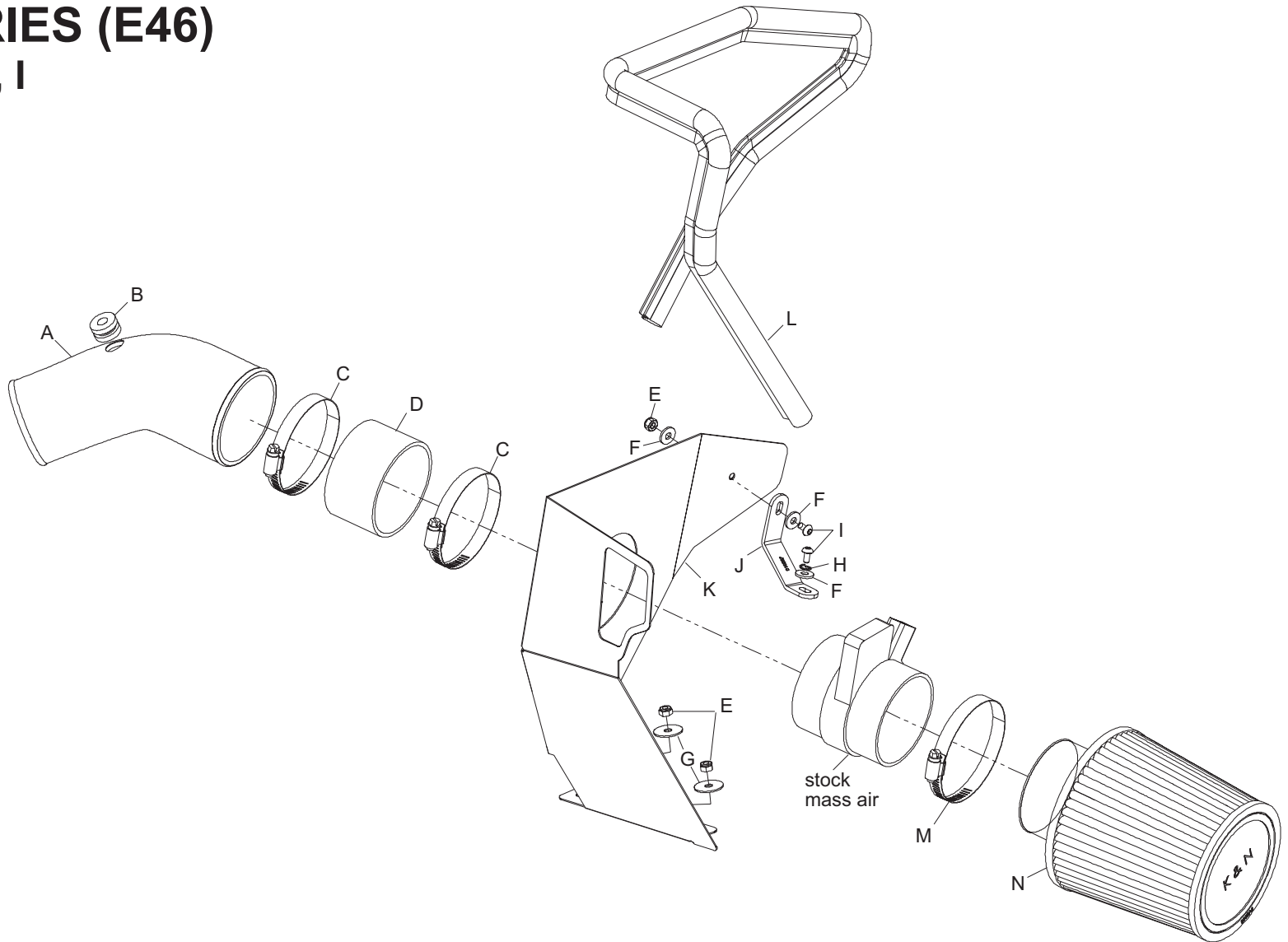

PARTS LIST:

Description	Qty.	Part #
A Intake Tube	1	087138
B Grommet; Black, Rubber	1	08100
C Hose Clamp; #56	2	08620
D Silicone Hose	1	08630
E Nut; 6mm Nylock	3	07553
F Washer; 1/4"OD X 5/8"OD, Flat	3	08275
G Washer; 1/4"ID X 1"OD, Fender	2	08160
H Washer; 1/4" Split Lock	1	08198
I Bolt; M6-1.00 X 20mm	2	07730
J Bracket "C"	1	010087
K Heat Shield	1	07495
L Edge Trim 50"	1	102481
M Hose Clamp # 60	1	08624
N Air Filter	1	RC-4630

NOTE: FAILURE TO FOLLOW INSTALLATION INSTRUCTIONS AND NOT USING THE PROVIDED HARDWARE MAY DAMAGE THE INTAKE TUBE, THROTTLE BODY AND ENGINE.

TO START:

1. Turn off the ignition and disconnect the negative battery cable.

NOTE: Disconnecting the negative battery cable erases pre-programmed electronic memories. Write down all memory settings before disconnecting the negative battery cable. Some radios will require an anti-theft code to be entered after the battery is reconnected. The anti-theft code is typically supplied with your owner's manual. In the event your vehicles' anti-theft code cannot be recovered, contact an authorized dealership to obtain your vehicles anti-theft code.



2. Release the locking tab and disconnect the mass air sensor electrical connection.

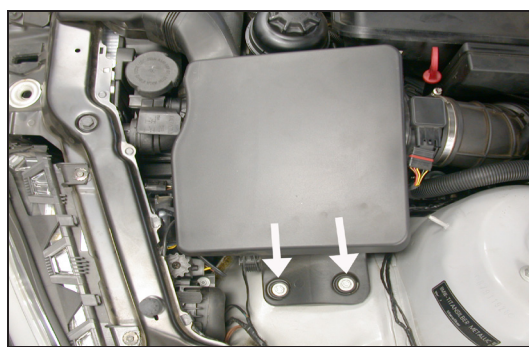

3. Remove the two factory air box mounting bolts shown.



4. Loosen then hose clamp which secures the factory intake tube to the mass air sensor, then disconnect the intake hose from the mass air sensor as shown.



5. Unhook the wiring harness retainer shown from the rear of the box.



6. Lift the air box from the rear and remove it from the vehicle.
NOTE: Pull the air box backwards to dislodge the upper and lower fresh air intake.



7. Pull up on the vent tube to dislodge it from the intake tube as shown.



8. Loosen the lower hose clamp, which secures the upper intake tube to the lower intake tube, and then remove the upper intake tube from the vehicle.

NOTE: K&N Engineering, Inc., recommends that customers do not discard factory air intake.

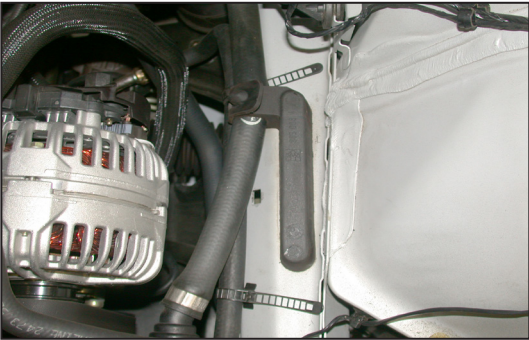

9. Unclip the rubber strap, which secures the heater hose to the lower air box locator.

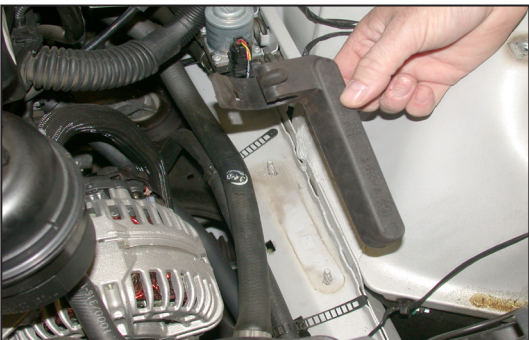

10. Pull up the lower air box locator to remove it from the mounting studs and then from the vehicle.



11. Install the provided grommet into the intake tube as shown.



12. Install the intake tube into the factory lower intake tube and secure with the factory hose clamp.

NOTE: Do not completely tighten the hose clamp at this time.



13. Insert the factory vent tube into the grommet in the intake tube as shown.



14. Install the provided edge trim onto the heat shield as shown.

NOTE: Some trimming of the edge trim may be necessary.



15. Remove the fresh air duct from the air box as shown.



16. Install the fresh air duct into the heat shield as shown.



17. Install the heat shield assembly into the vehicle and secure with the provided fender washers and 6mm nuts onto the lower air box mount studs. Re-install the fresh air hose into the fresh air duct.

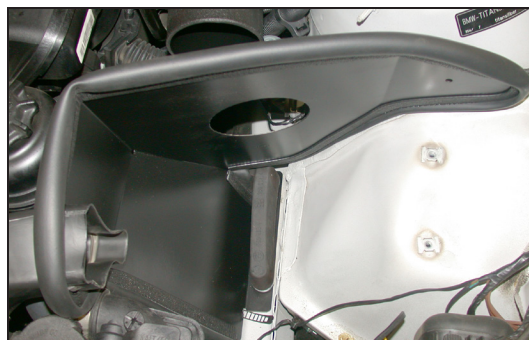

18. Reinstall the lower air box locator removed in step #10 and resecure the heater hose.

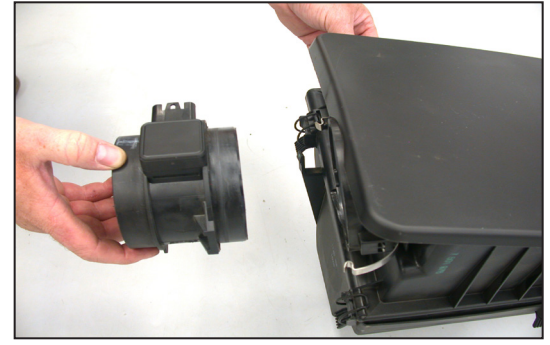

19. Unhook the two mass air sensor retaining clips and remove the mass air sensor from the air box.

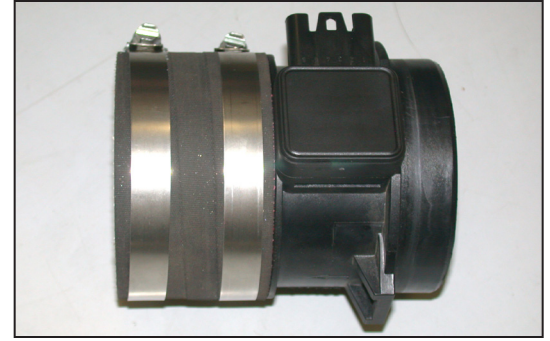

20. Install the silicone hose (08630) onto the mass air sensor and secure with the provided hose clamp.

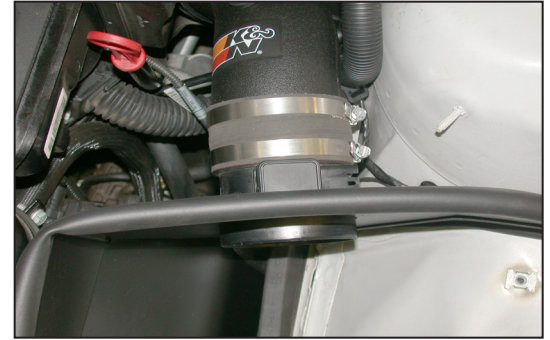

21. Install the mass air sensor assembly into the heat shield and onto the K&N® intake tube, secure with the provided hose clamp.



22. Secure the provided bracket (010087) onto the heat shield and inner fender with the provided hardware as shown.

NOTE: The long side of the bracket attaches to the heat shield.



23. Install the air filter onto the mass air sensor and secure with the provided hose clamp.

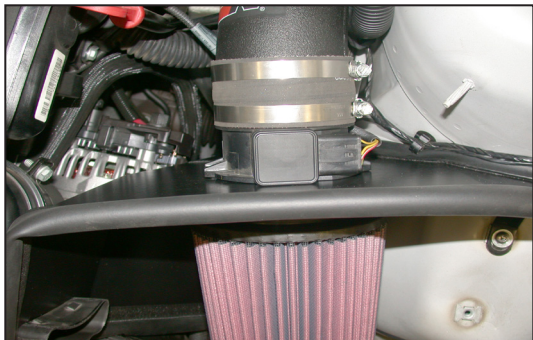

24. Reconnect the mass air sensor electrical connection.



25. Reconnect the vehicle's negative battery cable. Double check to make sure everything is tight and properly positioned before starting the vehicle.

26. The C.A.R.B. exemption sticker, (attached), must be visible under the hood so that an emissions inspector can see it when the vehicle is required to be tested for emissions. California requires testing every two years, other states may vary.

27. It will be necessary for all K&N® high flow intake systems to be checked periodically for re-alignment, clearance and tightening of all connections. Failure to follow the above instructions or proper maintenance may void warranty.

ROAD TESTING:

1. Start the engine with the transmission in neutral or park, and the parking brake engaged. Listen for air leaks or odd noises. For air leaks secure hoses and connections. For odd noises, find cause and repair before proceeding. This kit will function identically to the factory system except for being louder and much more responsive.

2. Test drive the vehicle. Listen for odd noises or rattles and fix as necessary.

3. If road test is fine, you can now enjoy the added power and performance from your kit.

4. K&N Engineering, Inc., requires cleaning the intake system's air filter element every 100,000 miles. When used in dusty or off-road environments, our filters will require cleaning more often. We recommend that you visually inspect your filter once every 25,000 miles to determine if the screen is still visible. When the screen is no longer visible some place on the filter element, it is time to clean it. To clean and re-oil, purchase our filter Recharger® service kit, part number 99-5050 or 99-5000 and follow the easy instructions.