



INSTALLATION INSTRUCTIONS

77-1529KP DODGE 2002-12 Ram 1500 V8-4.7L

NOTE: This kit was not designed to fit vehicles with a body lift.

TOOLS NEEDED:

8mm Socket
10mm Socket
13mm Socket
Flat Blade Screwdriver
Ratchet

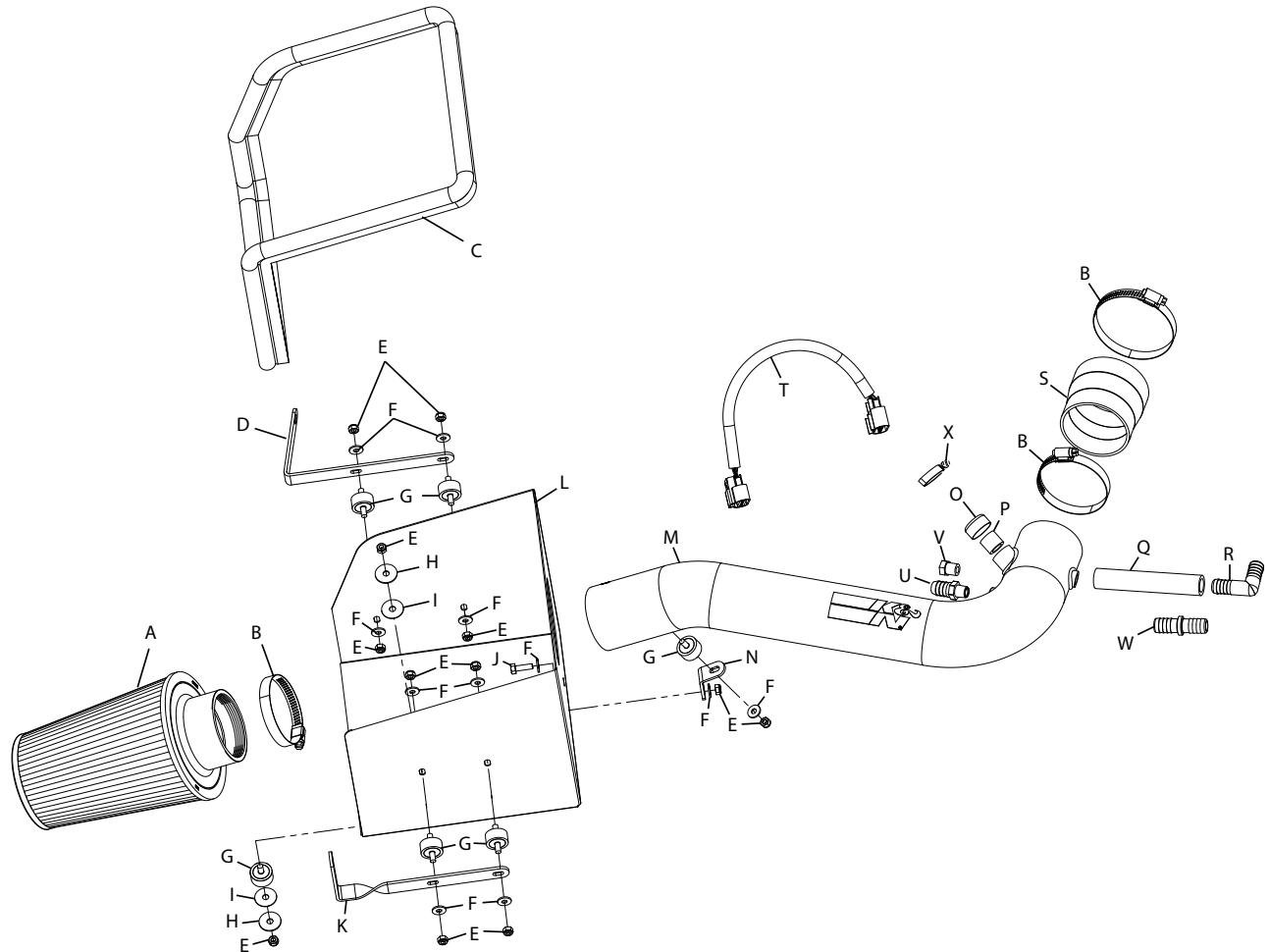

PARTS LIST:

Description	Qty.	Part #	Description	Qty.	Part #	Description	Qty.	Part #
A Air Filter	1	RC-5106	I Washer, Rubber	2	21685	Q Hose, 1/2"ID x 14"L, Silicone	1	08402
B Hose Clamp, #48	3	08601	J Bolt, M6-1.00 x 20mm L, Hex	1	07795	R Vent, 5/8" Barb, 90°	1	08072
C Edge Trim, 57" L	1	102470	K Twist Bracket, "L"	1	070048	S Hose, Step, Silicone	1	08429
D Angle Bracket, "Large"	1	070050	L Heat Shield	1	07487	T Dodge Extension Harness	1	21680
E Nut, 6mm Nylock	12	07512	M Intake Tube	1	27106-1	U Vent; Strt., 5/8 Barbed 1/4 NPT, Nylon	1	08911
F Washer, 6mm Flat	11	08269	N Angle Bracket, "Small"	1	070049	V Plug; 1/4 NPT, Plastic, Black	1	08032
G 6mm Rubber Mounted Stud	6	07027	O Cap Plug	1	06837	W Vent; Strt., 5/8" Hose - 5/8"Hose	1	08048
H Washer, Fender	2	08160	P Hose, 17/32"ID x 11/16"L, Silicone	1	084054	X Hose clamp #10 mini	1	08411

NOTE: FAILURE TO FOLLOW INSTALLATION INSTRUCTIONS AND NOT USING THE PROVIDED HARDWARE MAY DAMAGE THE INTAKE TUBE, THROTTLE BODY AND ENGINE.

TO START:

1. Turn off the ignition and disconnect the negative battery cable.

NOTE: Disconnecting the negative battery cable erases pre-programmed electronic memories. Write down all memory settings before disconnecting the negative battery cable. Some radios will require an anti-theft coded to be entered after the battery is reconnected. The anti-theft code is typically supplied with your owner's manual. In the event your vehicles' anti-theft code cannot be recovered, contact an authorized dealership to obtain your vehicles anti-theft code.



2. Loosen the hose clamp that connects the intake tube to the resonator box then remove the intake tube.



2a. On 2008 and later model year vehicles, disconnect the crank case vent hose from the air box as shown.



3. Lift up firmly to release the air box from mounting studs, then remove completely.



4. On models that come equipped with air temp sensors, unplug the air temp. sensor electrical connection as shown.

NOTE: On some models the air temperature sensor may be in the front of the resonator chamber.



5. Remove the two 10mm bolts that retain the resonator box onto the engine.

NOTE: On 2008 and later model year vehicles there will be only one bolt to secure the resonator.



6. Pull up firmly to release the resonator from the engine.

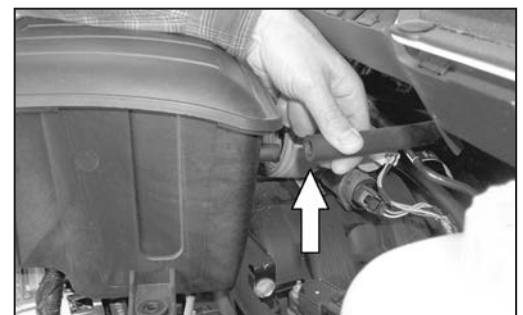

7. On 2002-2007 model year vehicles, disconnect the crank case vent hose from resonator as shown, then remove resonator from vehicle.

NOTE: K&N Engineering, Inc., recommends that customers do not discard factory air intake.



8. On 2002-2007 model year vehicles, loosen the hose clamp that retains the rubber hose to the throttle body and remove as shown.

Continued



9. Loosen and remove the eight bolts that secure the inner fender valance; lower the valance down as shown.

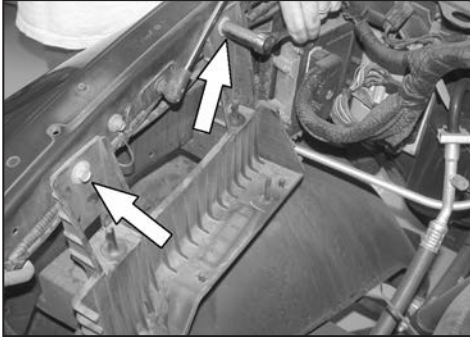

10. Remove the air cleaner support bracket, that is secured by the two bolts on the upper fender and two bolts on the lower fender.



11. Reinstall the inner fender removed in step #9. **NOTE: Two of the retaining bolts will not be used.**

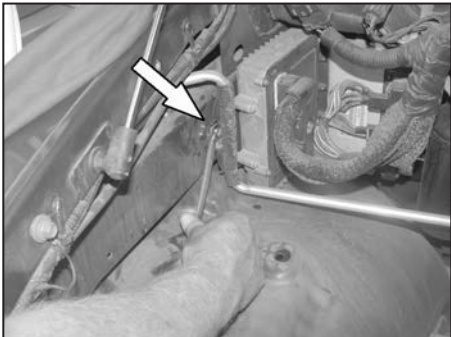

12. Remove the bolt that secures the computer to the inner fender as shown.

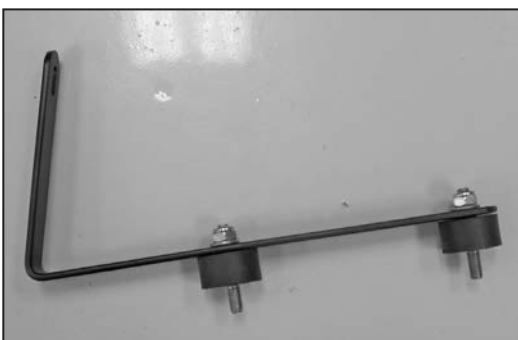

13. Secure the rubber mounted studs to the large angle bracket using the provided hardware as shown, but do not tighten completely at this time.



14. Secure the angle bracket assembly to the threaded hole from step 12 and secure with the stock bolt.

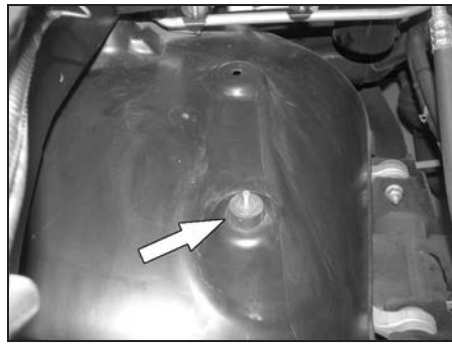

15. Install the provided rubber mounted stud into the existing hole on the inner fender and secure from underneath the inner fender with the provided rubber washer, fender washer and nylock nut as shown.



16. Secure the provided rubber mounted studs to the provided "L" twist bracket using the provided hardware as shown.

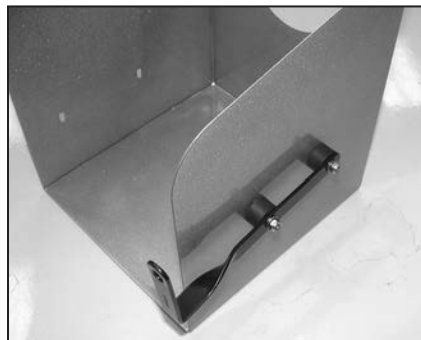

17. Install the "L" bracket assembly onto the heat shield with the provided hardware as shown.

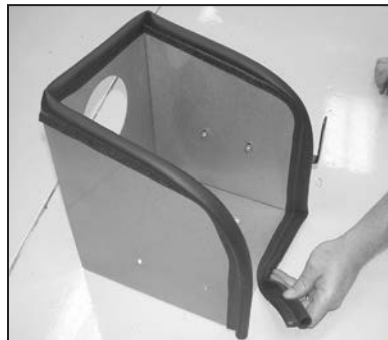

18. Install the provided edge trim onto the heat shield and trim to fit.

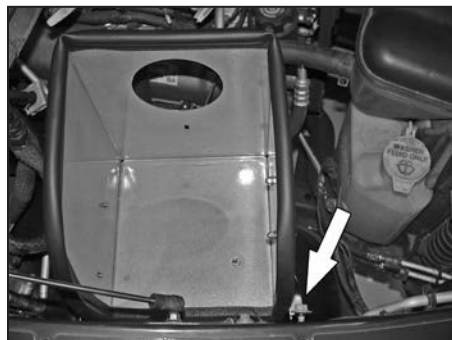

19. Install the heat shield assembly onto the rubber mounted studs and line up the "L" bracket with the threaded hole from step 12 and secure with the stock bolt as shown.



20. Install the silicone hose and hose clamps onto the throttle body and tighten as shown.



21. On vehicles not equipped with an air temperature sensor, install the provided cap plug and secure with the provided hose clamp.



22. On vehicles equipped with an air temperature sensor, install the provided silicone hose into the vent on the K&N® intake tube as shown.

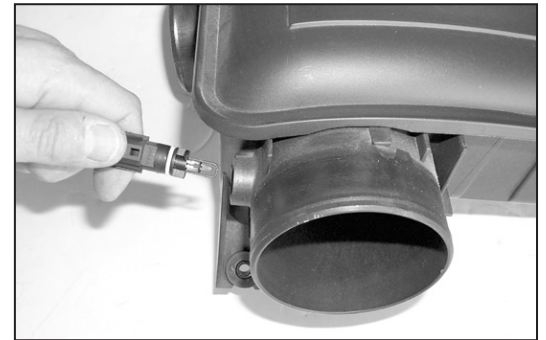

23. On models that come equipped with temp sensors, remove the air temp sensor from the resonator as shown.

NOTE: Take care when removing the air temperature sensor as it is very fragile.
NOTE: On 2008 and later model year vehicles, the air temperature sensor is located on the front of the resonator.



24. Remove the O-ring from the air temp. sensor as shown.

NOTE: Take care while handling the air temperature sensor as it is very fragile.



25. On vehicles equipped with an air temperature sensor, install the air temperature sensor into the silicone hose as shown.

NOTE: Take care while inserting the air temperature sensor as it is very fragile.

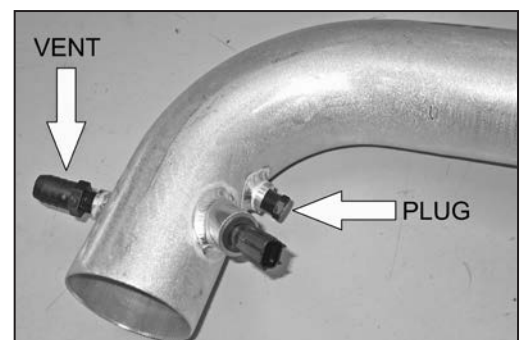

25a. On 2002-2007 model year vehicles, install the 1/4" npt vent fitting and plug as shown.

Continued

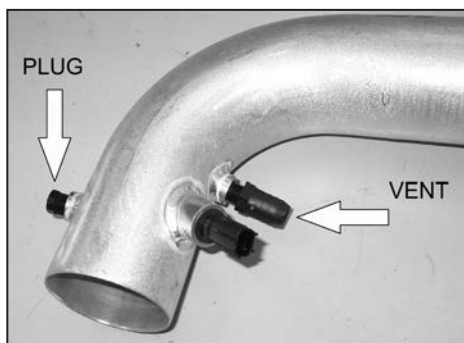

25b. On 2008 and later model year vehicles, install the 1/4"npt vent fitting and plug as shown.
NOTE: Plastic NPT fittings are easy to cross thread. Install the vent fitting "hand" tight, then turn it two complete turns with a wrench.



26. Install the rubber mounted stud into the threaded boss on the K&N® intake tube as shown.



27. Secure the provided small angle bracket to the rubber mounted stud using the provided hardware as shown.



28. Install the K&N® intake tube into the silicone hose at the throttle body and align the mounting bracket with the heat shield. Secure the intake tube with the hose clamp and hardware provided.

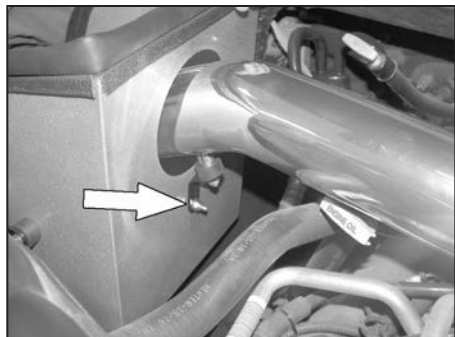

29. Line up the angle bracket with the heat shield and secure with the provided hardware as shown.



30. Install the remaining hardware, adjust the heat shield for best fit and clearance; tighten all hardware as shown.



31. On vehicles with the crank case vent hose connected to the "T" on the drivers side of the engine, install the 90° vent fitting into the stock crank case hose as shown.



32. Install the provided silicone hose onto the 90° vent, then connect the other end of the silicone hose onto the vent attached to the K&N® intake tube.

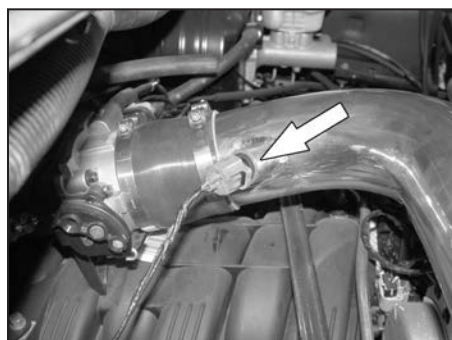

33. On 2002-2007 model year vehicles, reconnect the inlet air temperature sensor electrical connection as shown.



33a. On 2008 and later model year vehicles, connect the provided inlet air temperature sensor extension harness into the factory connection as shown.

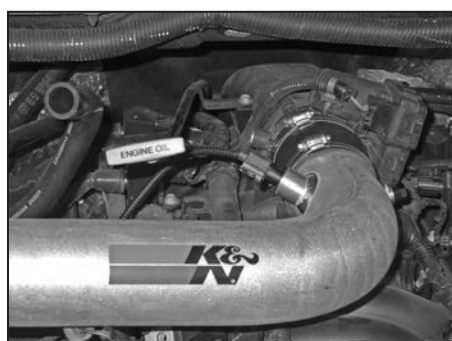

33b. Connect the open end of the inlet air temperature sensor extension harness into the inlet air temperature sensor as shown.



34. On models where the crank case vent hose is connected to the "T" on the passengers side of the engine, remove the complete vent tube assembly from the rubber fittings in each valve cover as shown.



35. Cut the crank case vent tube 1" from the "T" fitting as shown.
NOTE: Cut the tube that was originally fastened to the air box.



36. Rotate the long side of the vent tube assembly 180° as shown.



37. Reinstall the vent tube assembly into the rubber fittings in each valve cover so that the "T" fitting is now on the drivers side of the engine facing forward.



38. Connect the provided vent hose onto the "T" fitting, then connect the other end onto the intake tube.



39. On models where the crank case vent hose is connected to the passenger side valve cover, remove the factory 90° coupling hose from the plastic vent tube.
NOTE: On 2008 and later model year vehicles, disconnect the crank case vent hose directly from the valve cover.

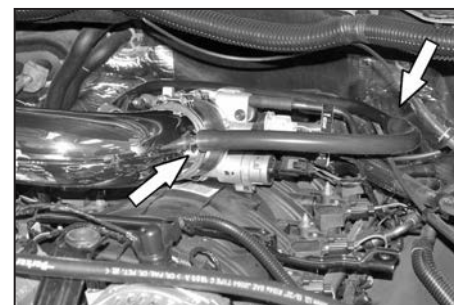

40. On models with the crank case vent tube connected to the passenger side valve cover, connect the provided silicone hose to the factory vent tube. Then, route the crank case vent tube assembly behind the throttle body as shown. Connect the open end onto the K&N® intake tube.



41a. On 2008 and later model year vehicles, remove the crank case vent hose from the passenger side valve cover as shown.

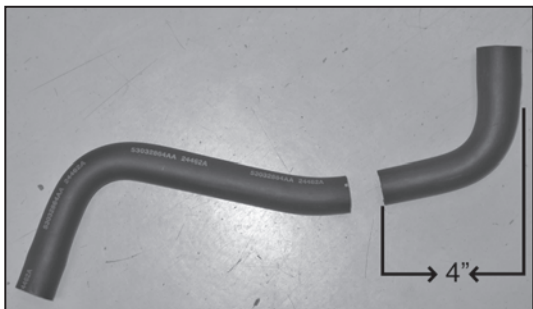

41b. On 2008 and later model year vehicles, cut the factory crank case vent hose 4" from the end as shown.



41c. On 2008 and later model year vehicles, install the provided hose mender and crank case vent hose onto the cut factory vent hose as shown.

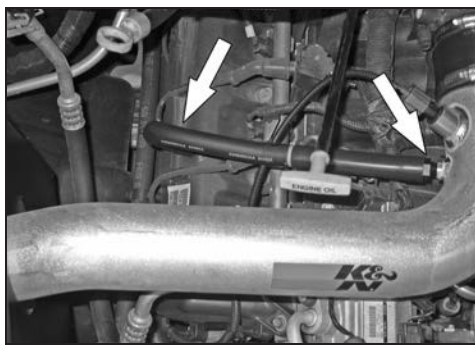

41d. On 2008 and later model year vehicles, install the crank case vent hose assembly onto the valve cover and intake tube as shown.

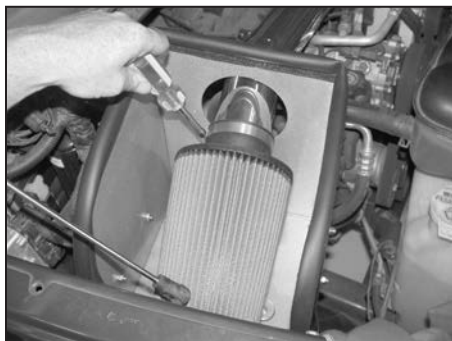

42. Install the air filter and secure with the provided hose clamp as shown.

NOTE: Drycharger® air filter wrap; part # RC-5106DK is available to purchase separately. To learn more about Drycharger® filter wraps or look up color availability please visit <http://www.knfilters.com>®.



43. Reconnect the vehicle's negative battery cable. Double check to make sure everything is tight and properly positioned before starting the vehicle.

44. The C.A.R.B. exemption sticker, (attached), must be visible under the hood so that an emissions inspector can see it when the vehicle is required to be tested for emissions. California requires testing every two years, other states may vary.

45. It will be necessary for all K&N® high flow intake systems to be checked periodically for realignment, clearance and tightening of all connections. Failure to follow the above instructions or proper maintenance may void warranty.

ROAD TESTING:

1. Start the engine with the transmission in neutral or park, and the parking brake engaged. Listen for air leaks or odd noises. For air leaks secure hoses and connections. For odd noises, find cause and repair before proceeding. This kit will function identically to the factory system except for being louder and much more responsive.

2. Test drive the vehicle. Listen for odd noises or rattles and fix as necessary.

3. If road test is fine, you can now enjoy the added power and performance from your kit.

4. K&N Engineering, Inc., requires cleaning the intake system's air filter element every 100,000 miles. When used in dusty or off-road environments, our filters will require cleaning more often. We recommend that you visually inspect your filter once every 25,000 miles to determine if the screen is still visible. When the screen is no longer visible some place on the filter element, it is time to clean it. To clean and re-oil, purchase our filter Recharger® service kit, part number 99-5050 or 99-5000 and follow the easy instructions.