



INSTALLATION INSTRUCTIONS

57-2581

FORD

2011-14 F-150

V8-5.0L

NOTE: This kit was not designed to fit vehicles with a body lift.

TOOLS NEEDED:

- Flat Blade Screwdriver
- 9/16" Wrench
- 3/4" Wrench
- T-20 Torx
- 3mm Allen Wrench
- 4mm Allen Wrench

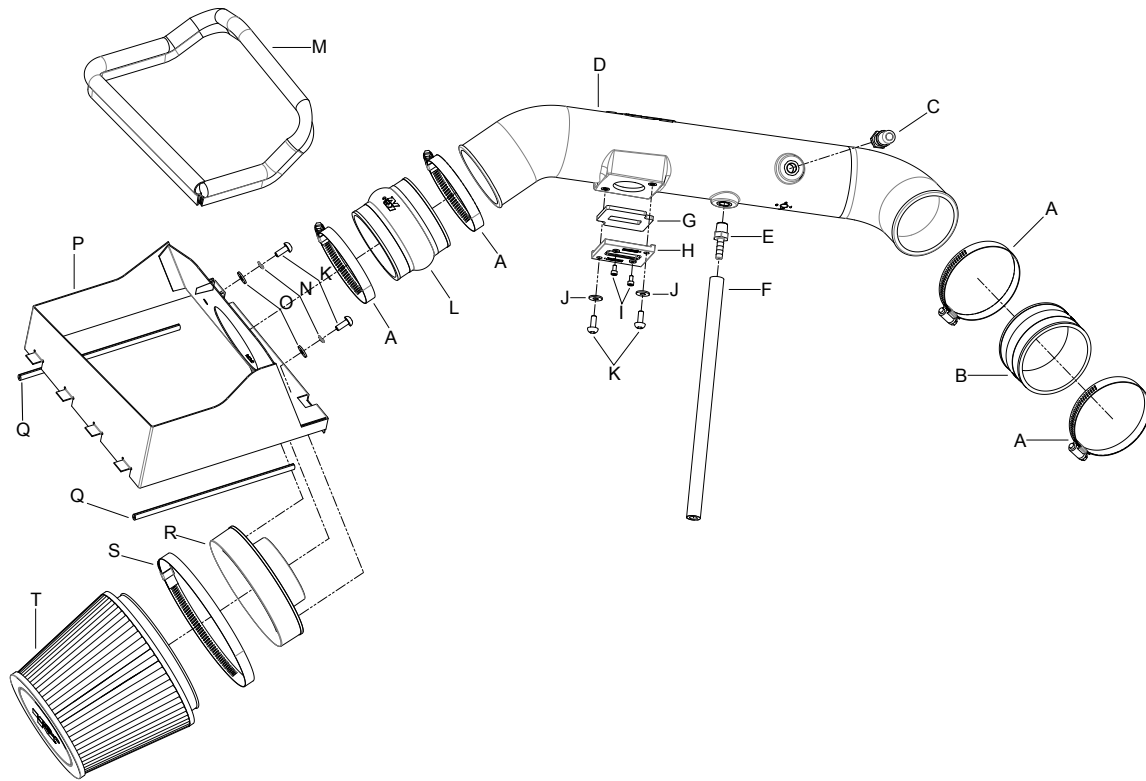

PARTS LIST:

Description	Qty.	Part #
A Hose Clamp #56	4	08620
B Hose; 3-1/2" ID X 2" L Molded	1	08630
C Vent; 1/4 NPT to Quick Disconnect	1	082628
D Intake Tube	1	087247
E Vent; STRT, 3/8" Hose, 1/4" NPT, Plas.	1	08047
F Hose; 3/8" ID X 12" L	1	08412
G Gasket; 3/16	1	09069
H Adaptor; #420, Nylon 6/6 GF, Black	1	21515
I Bolt; M4- 0.07 8MM, A/H Cap SS	2	07733
J Washer; 6MM Flat, SS	2	08269
K Bolt; M6 X 1.00 X 16MM, Buttonhead, SS	4	07730
L Hose; 3-1/2" ID X 3" L Hump Molded	1	084057
M Edge Trim (35")	1	102471
N Washer; M6 Split Lock Zinc	2	1-3025
O Washer; 1/4" ID X 5/8" OD- SAE	2	08275
P Heat Shield	1	074076
Q Edge Trim (19")	1	102451
R Adapter; Universal, 6" Filter 3.5" Coupler	1	21512-1
S Hose Clamp #104	1	08697
T Air Filter	1	RC-5173

NOTE: FAILURE TO FOLLOW INSTALLATION INSTRUCTIONS AND NOT USING THE PROVIDED HARDWARE MAY DAMAGE THE INTAKE TUBE, THROTTLE BODY AND ENGINE.

TO START:

1. Turn off the ignition and disconnect the negative battery cable.

NOTE: Disconnecting the negative battery cable erases pre-programmed electronic memories. Write down all memory settings before disconnecting the negative battery cable. Some radios will require an anti-theft code to be entered after the battery is reconnected. The anti-theft code is typically supplied with your owner's manual. In the event your vehicles' anti-theft code cannot be recovered, contact an authorized dealership to obtain your vehicles anti-theft code.



2. Release the red locking tab and then disconnect the mass air sensor electrical connection.



3. Rotate the locking tab and then unhook the crankcase vent hose from the factory intake tube.

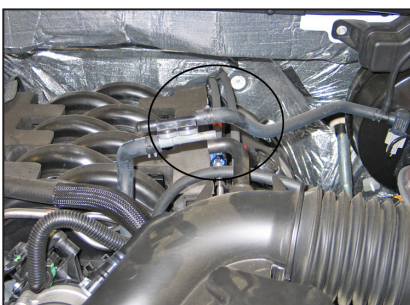

4. Disconnect the EVAP hose from the check valve as shown.

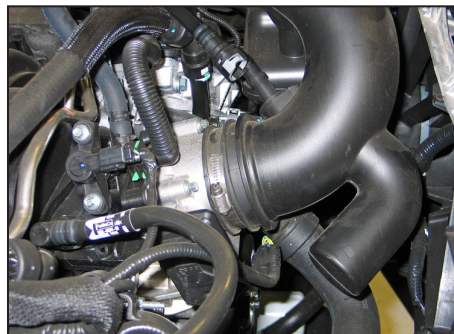

5. Loosen the hose clamp securing the factory intake tube to the throttle body.

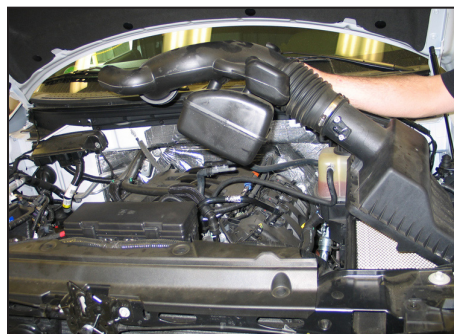

6. Release the three clips securing the upper airbox housing to the lower housing and then remove the intake tube/upper airbox and air filter from the vehicle.

NOTE: K&N Engineering, Inc., recommends that customers do not discard factory air intake.

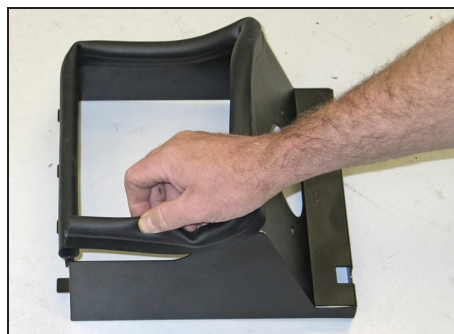

7. Install the provided edge trim onto the heat shield as shown.

NOTE: Some trimming of the edge trim will be necessary.

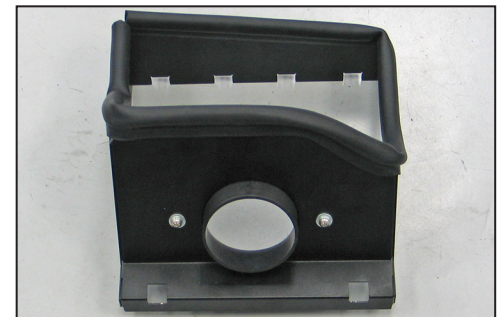

8. Install the filter adapter into the heat shield and secure with the provided hardware.

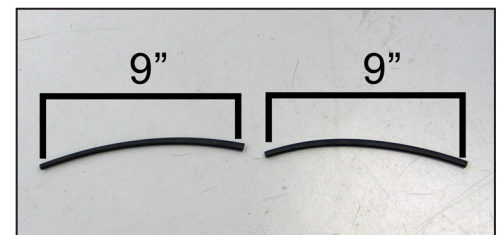

9. Cut the provided edge trim into two 9" sections as shown.

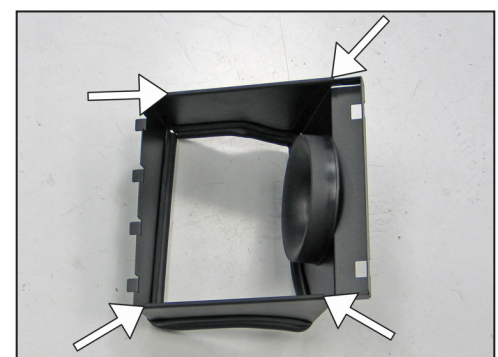

10. Install the two 9" sections of edge trim onto the bottom of the heat shield as shown.



11. Install the K&N® air filter onto the filter adapter and secure with the provided hose clamp.

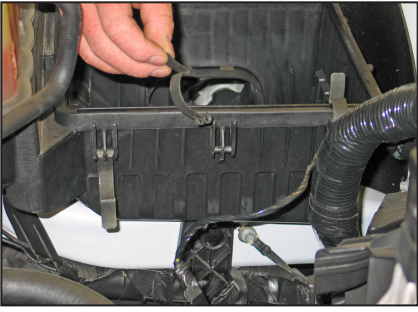

12. Remove the center airbox retaining clip.



13. Install the heat shield/filter assembly onto the lower airbox and secure with the factory airbox retaining clips.

NOTE: A gap is normal between the lower airbox and the heat shield on the clip side of the heat shield.

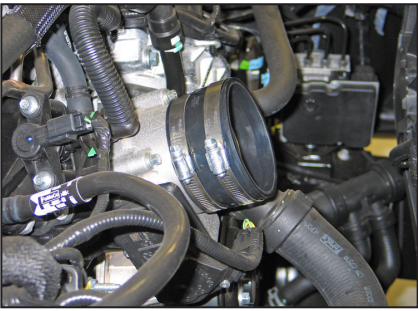

14. Install the provided silicone hose (08630) onto the throttle body and secure with the provided hose clamp.



15. Install the provided silicone hose (084057) onto the filter adapter and secure with the provided hose clamp.

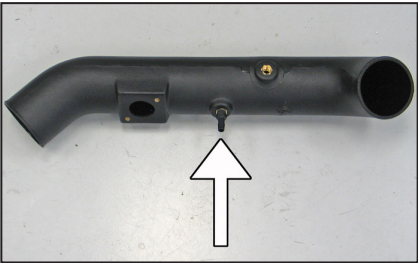

16. Install the provided 3/8" hose fitting into the K&N® intake tube as shown.

NOTE: Plastic NPT fittings are easy to cross thread. Install the vent fitting "hand" tight, then turn it two complete turns with a wrench.

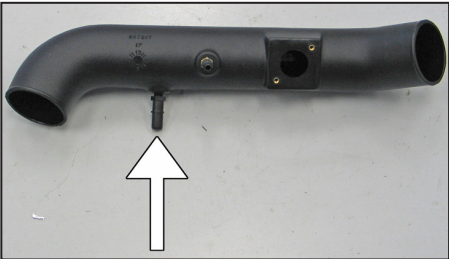

17. Install the provided quick disconnect fitting into the K&N® intake tube as shown.

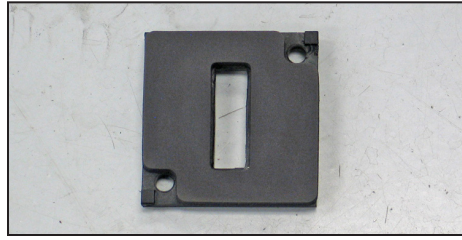

18. Install the provided gasket onto the mass air sensor adapter as shown.

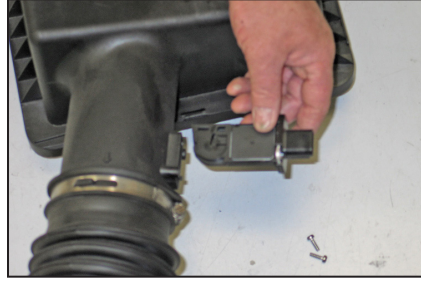

19. Remove the two screws securing the mass air sensor and then remove the mass air sensor from the stock intake tube as shown.

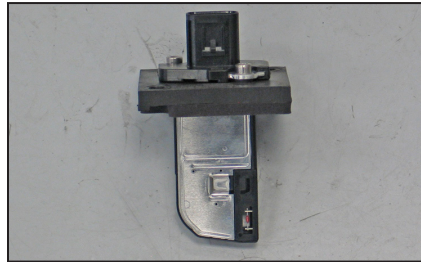

20. Install the mass air sensor into the K&N® sensor adapter as shown. Secure with the provided hardware.

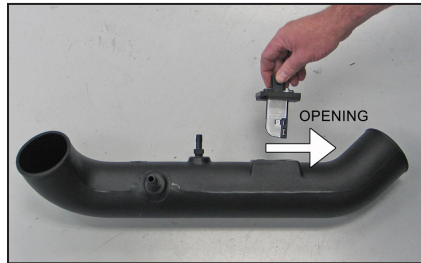

21. Install the mass air sensor assembly into the K&N® intake tube and secure with the provided hardware.

NOTE: Be sure to install the mass air sensor in the correct direction, the opening is to be towards the filter end of the tube.

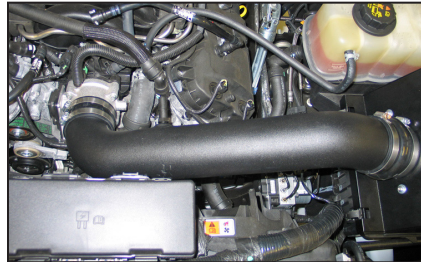

22. Install the K&N® intake tube assembly into the silicone hose at the filter adapter and then into the silicone hose on the throttle body and secure with the provided hose clamps.

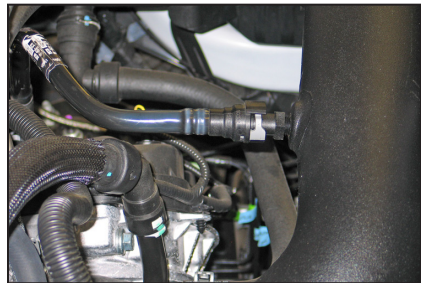

23. Connect the crankcase vent hose to the quick disconnect fitting in the K&N® intake tube.

NOTE: It is necessary to rotate the plastic crankcase vent tube on the plastic connector that attaches to the valve cover approximately 1/4 turn counter clockwise for the tube to align with the fitting on the K&N intake tube.

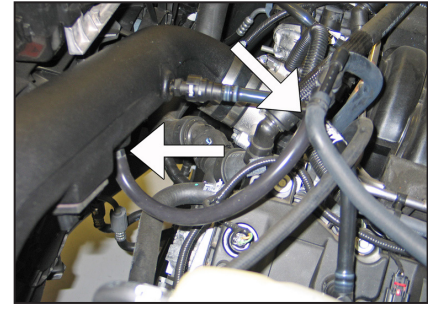

24. Install the provided silicone hose onto the 3/8" fitting installed in the K&N® intake tube and then attach the open end to the EVAP check valve.



25. Reconnect the mass air sensor electrical connection.



26. Reconnect the vehicle's negative battery cable. Double check to make sure everything is tight and properly positioned before starting the vehicle.

27. The C.A.R.B. exemption sticker, (attached), must be visible under the hood so that an emissions inspector can see it when the vehicle is required to be tested for emissions. California requires testing every two years, other states may vary.

28. It will be necessary for all K&N® high flow intake systems to be checked periodically for realignment, clearance and tightening of all connections. Failure to follow the above instructions or proper maintenance may void warranty.

ROAD TESTING:

1. Start the engine with the transmission in neutral or park, and the parking brake engaged. Listen for air leaks or odd noises. For air leaks secure hoses and connections. For odd noises, find cause and repair before proceeding. This kit will function identically to the factory system except for being louder and much more responsive.

2. Test drive the vehicle. Listen for odd noises or rattles and fix as necessary.

3. If road test is fine, you can now enjoy the added power and performance from your kit.

4. K&N Engineering, Inc., requires cleaning the intake system's air filter element every 100,000 miles. When used in dusty or off-road environments, our filters will require cleaning more often. We recommend that you visually inspect your filter once every 25,000 miles to determine if the screen is still visible. When the screen is no longer visible some place on the filter element, it is time to clean it. To clean and re-oil, purchase our filter Recharger® service kit, part number 99-5050 or 99-5000 and follow the easy instructions.