



# INSTALLATION INSTRUCTIONS

## E-0780

### FORD

2003-07 F550 Super Duty

2003-07 F450 Super Duty

2003-07 F350 Super Duty

2003-07 F250 Super Duty

2003-05 Excursion

V8-6.0L Turbo Diesel

**NOTE:** This kit was not designed to fit vehicles with a body lift.

#### TOOLS NEEDED:

- 5/8" drill bit
- 5/16" socket
- 7/8" wrench
- 2.5mm allen wrench
- 3mm allen wrench
- 4mm allen wrench
- drill
- flat blade screwdriver
- ratchet

#### PARTS LIST:

Description	Qty.	Part #
A Hose Clamp #64	2	08645
B Hose; Double Hump	1	08613
C Wench; T20 T/R, Key	1	69801
D Extension Harness	1	21635-1
E Bolt; M4-.7 x 16MM, B/H/A	2	07793
F Block Off Plate, #453	1	21519
G Spacers	2	06530
H Gasket	1	09068
I Lid	1	087165
J Nut; 10-32, SS, Nylock	10	08253
K Washer;	10	08169
L Air Filter	1	E-3033
M Base	1	087164
N Set Screw; M8-1.25 x 25MM	2	07864
O Standoff	2	06532
P Grommet	1	082000
Q Hose Clamp #60	2	08628
R Hose; 4"ID x 2"L, Silicone	1	08761
S Intake Tube (FU)	1	087193

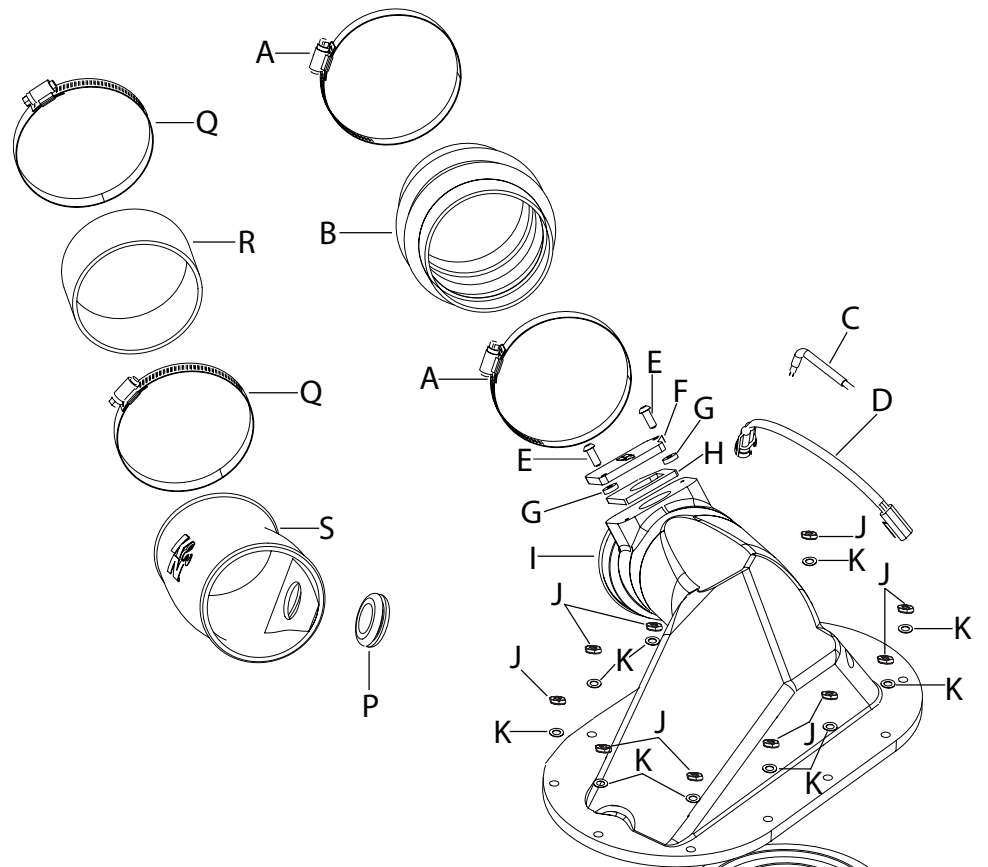

**NOTE: FAILURE TO FOLLOW INSTALLATION INSTRUCTIONS AND NOT USING THE PROVIDED HARDWARE MAY DAMAGE THE INTAKE TUBE, THROTTLE BODY AND ENGINE.**

#### TO START:

1. Turn off the ignition and disconnect the negative battery cable.

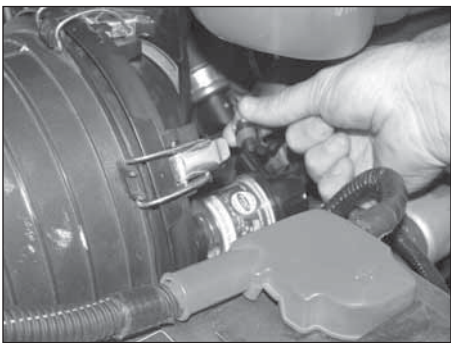

2. Disconnect the restrictor gauge electrical connection as shown.

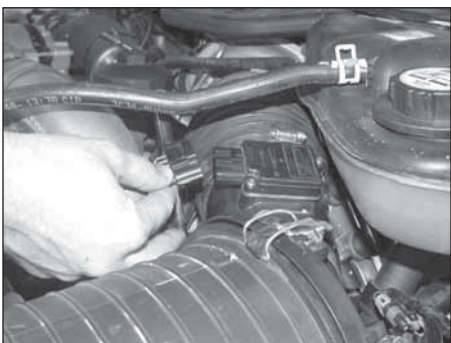

3. On vehicles equipped with a mass air sensor disconnect the mass air electrical connection as shown.

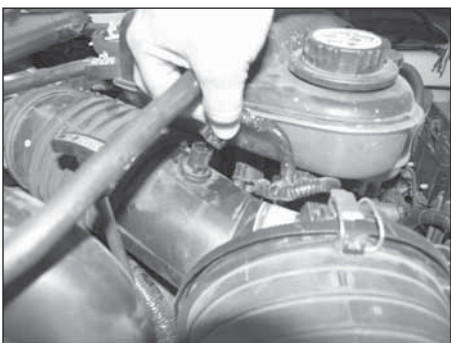

3a. On vehicles equipped with a air temperature sensor, disconnect the temperature sensor electrical connection as shown.



4. Release the four clamps that retains the front and back of air box.

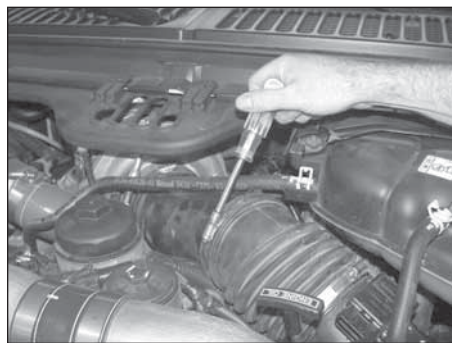

5. Loosen the hose clamp at the turbo inlet tube which secures the intake bellows as shown.

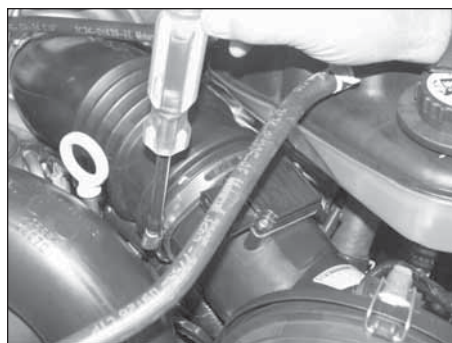

5a. On 2006 and later vehicles, loosen the hose clamp which secures the intake bellows and tube assembly to the rear air filter housing as shown.

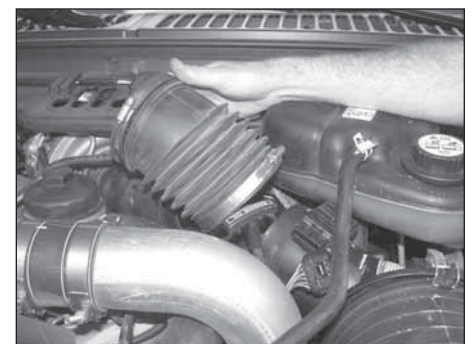

6. Loosen the hose clamp at the mass air sensor, then remove the intake hose from the vehicle.

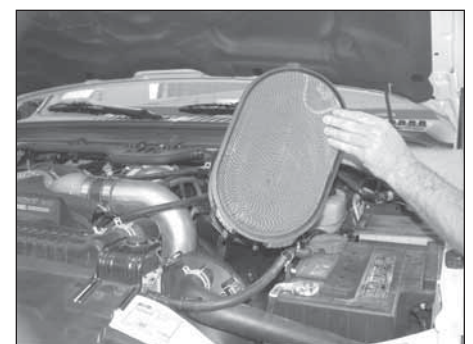

7. Remove the filter housing from vehicle as shown.

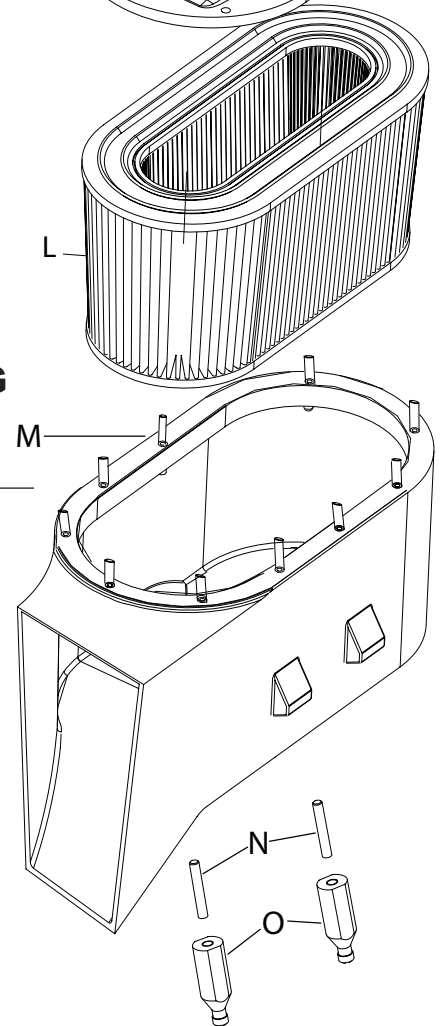

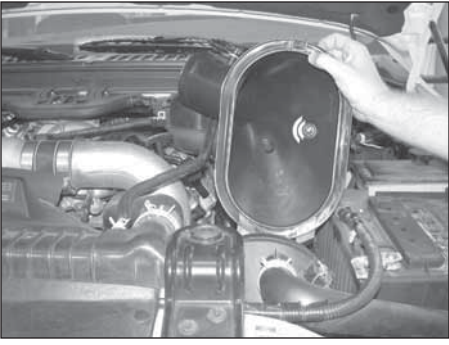

8. Remove the air box base as shown.



9. Remove the air box top as shown.

**NOTE: K&N Engineering, Inc., recommends that customers do not discard factory air intake.**

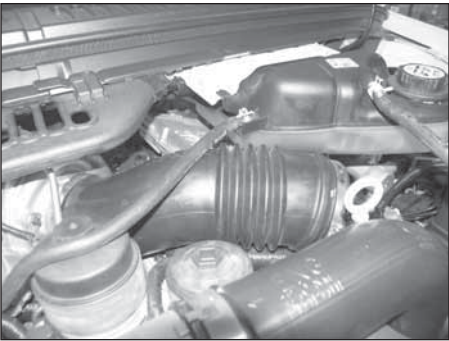

9a. On 2006 and later vehicles, loosen the hose clamp which secures the intake bellows and tube assembly to the turbo inlet.

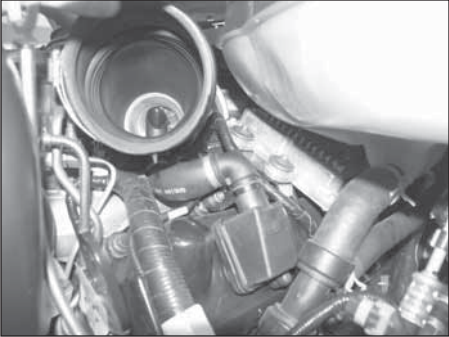

9b. On 2006 and later vehicles, using a large screwdriver, pry up on the crank case vent fitting in the valve cover to disengage it from the valve cover.  
**NOTE: Care must be used when disengaging the crank case vent fitting from the valve cover so as not to break it.**

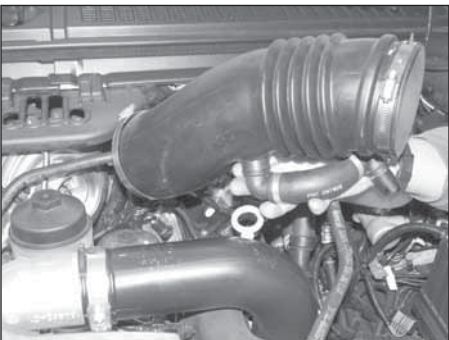

9c. On 2006 and later vehicles, remove the intake bellows and tube assembly from the vehicle as shown.



9d. On 2006 and later vehicles, install the silicone hose (08761) onto the turbo inlet and secure with the provided hose clamp.



10. On vehicles equipped with a mass air sensor remove the mass air sensor from the factory air box lid with the provided torx wrench as shown.

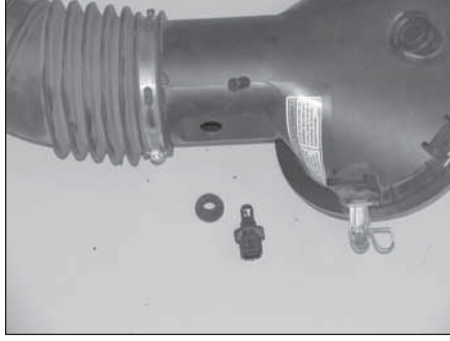

11. On vehicles equipped with an air temperature sensor, remove the air temperature sensor and grommet as shown.

**NOTE: Take care removing the temp sensor as it is very fragile.**

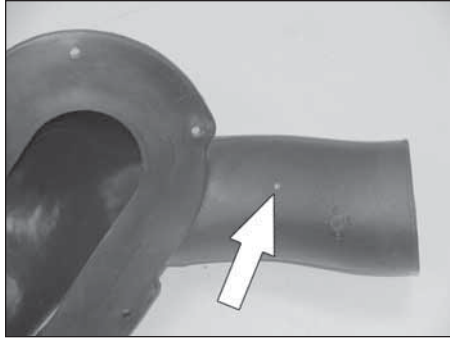

12. On vehicles equipped with an air temperature sensor, drill a 5/8" hole into the K&N® air box lid at the drill point shown.

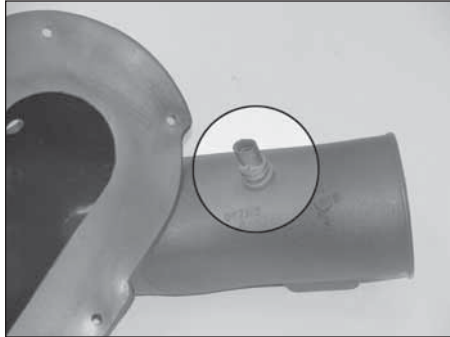

13. On vehicles equipped with the air temperature sensor, install the factory grommet and temperature sensor removed in step #11 into the K&N® intake tube at the hole drilled in step #12.

**NOTE: Take care when handling the temp sensor as it is very fragile.**

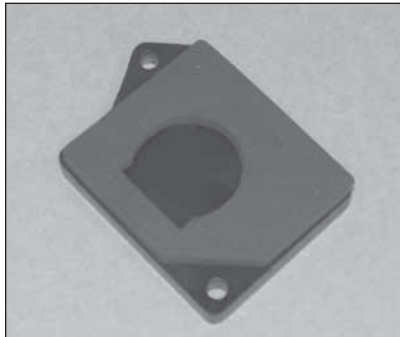

14. On vehicles equipped with an air temperature sensor, install the provided gasket onto the mass air block off plate as shown.



15. On vehicles equipped with an air temperature sensor, install the mass air block off plate onto the K&N® intake tube using the provided screws and spacers as shown.

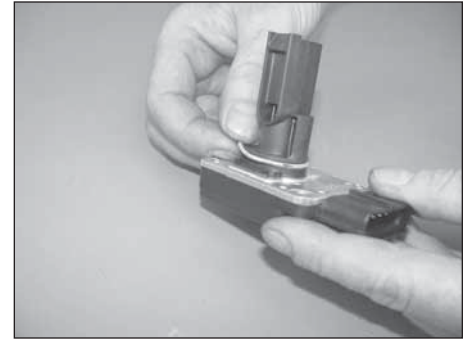

16. On vehicles equipped with a mass air sensor remove the factory O ring from the mass air sensor as shown.

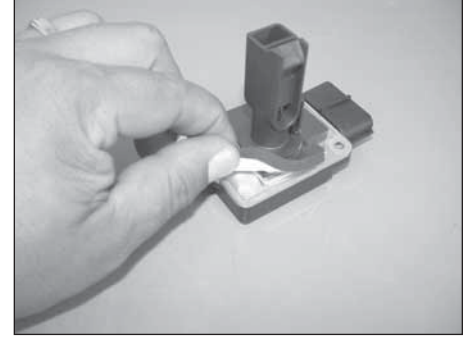

17. On vehicles equipped with a mass air sensor install the provided gasket onto the mass air sensor with the sticky side down.



18. On vehicles equipped with the mass air sensor install the mass air sensor onto the K&N® air box lid with the provided screws and spacers as shown.

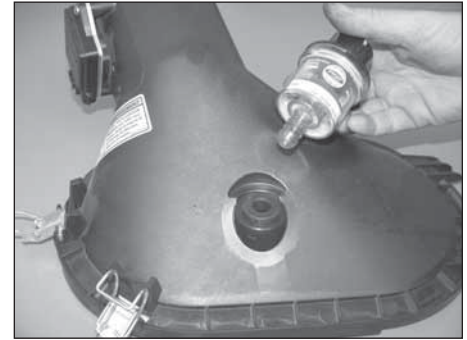

19. Remove the air filter restriction gauge and grommet from the factory air box.



20. Install the factory grommet and restriction gauge into the K&N® air box lid as shown.



21. Install the two 8mm studs into the mounting boss on the bottom of the K&N® air box base as shown.

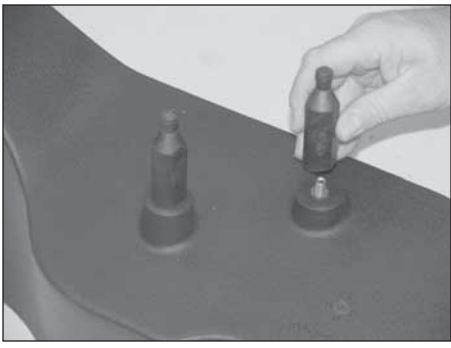

22. Install the two stand off pins onto the two studs installed in step #22.

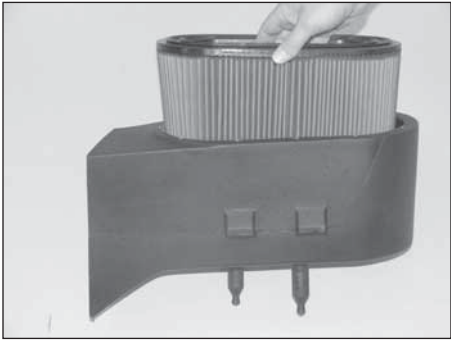

23. Install the K&N® air filter into the K&N® air box housing as shown.



23a. On 2006 and later vehicles, cut the band clamp which secures the crank case vent tube to the turbo inlet tube. Then remove the crank case tube assembly from the turbo inlet tube as shown.



23b. On 2006 and later vehicles, install the provided grommet into the K&N® turbo inlet tube as shown.



23c. On 2006 and later vehicles, install the crank case vent tube assembly removed in step #23a into the grommet on the K&N® turbo inlet tube as shown.

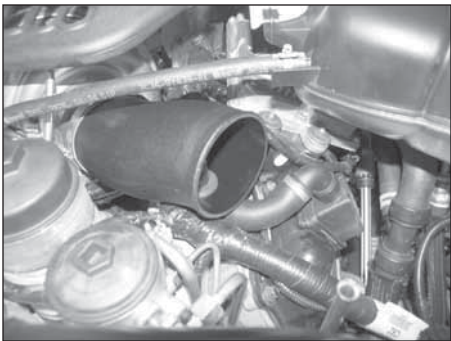

23d. On 2006 and later vehicles, install the K&N® turbo inlet tube assembly onto the turbo; rotate to align the crank case vent tube until it aligns with the vent port in the valve cover. Then snap the crank case vent tube into the valve cover and secure the tube with the provided hose clamp.

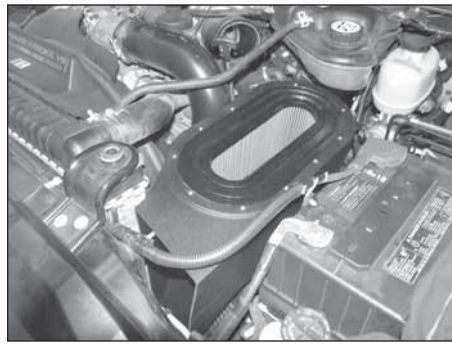

24. Install the K&N® air box base and filter into the stock location as shown.

**NOTE: Be sure the mounting guide pins are snapped into the factory air box mounting grommets.**

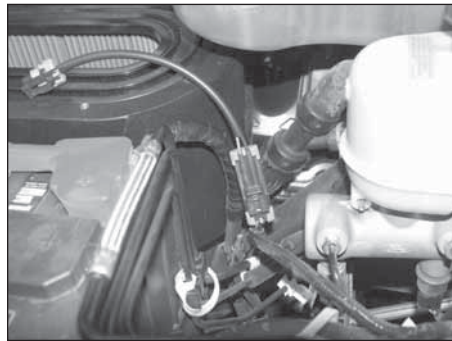

25. Install the provided wiring harness extension to the factory wiring harness filter minder connection as shown.

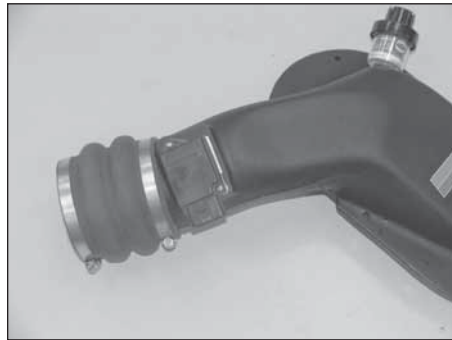

26. Install the silicone hose (08613) onto the K&N® air box lid with the provided hose clamp as shown.

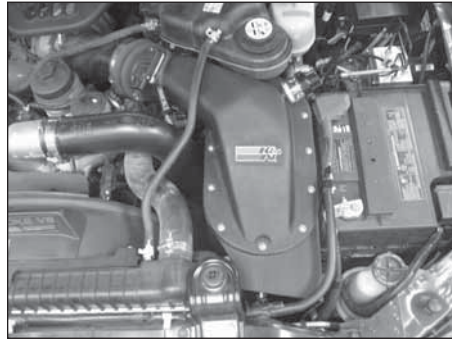

27. Install the K&N® air box lid onto the air box base making sure the silicone hose is completely installed onto the intake inlet. Install all ten air box lid mounting nuts and washers onto the lid. Once all the nuts are installed they can be tightened completely. Tighten the hose clamp, which secures the silicone hose to the throttle body.

**NOTE: All ten nuts must be installed or warranty will be voided.**

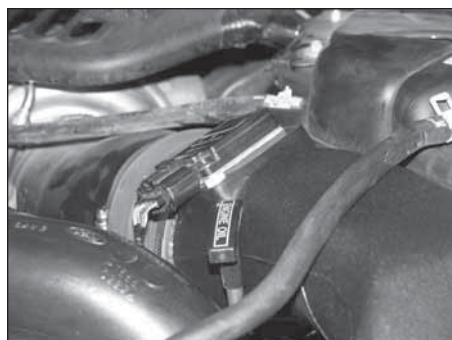

28. On vehicles equipped with a mass air sensor, connect the mass air sensor electrical connection. On vehicles equipped with an air temperature sensor, reconnect the air temperature sensor electrical connection.

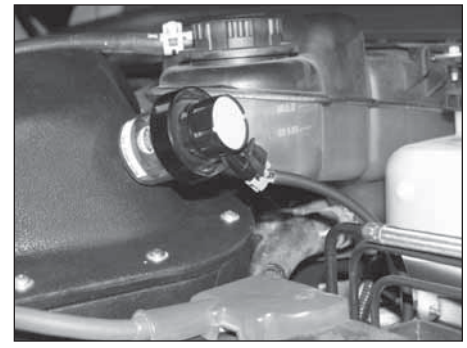

29. Connect the filter minder jumper harness into the filter minder as shown.

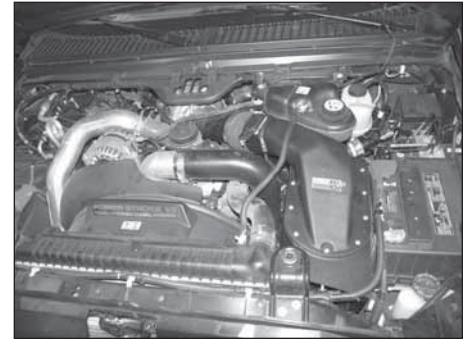

30. Reconnect the vehicle's negative battery cable. Double check to make sure everything is tight and properly positioned before starting the vehicle.

31. The C.A.R.B. exemption sticker, (attached), must be visible under the hood so that an emissions inspector can see it when the vehicle is required to be tested for emissions. California requires testing every two years, other states may vary.

32. It will be necessary for all K&N® high flow intake systems to be checked periodically for realignment, clearance and tightening of all connections. Failure to follow the above instructions or proper maintenance may void warranty.

#### ROAD TESTING:

1. Start the engine with the transmission in neutral or park, and the parking brake engaged. Listen for air leaks or odd noises. For air leaks secure hoses and connections. For odd noises, find cause and repair before proceeding. This kit will function identically to the factory system except for being louder and much more responsive.

2. Test drive the vehicle. Listen for odd noises or rattles and fix as necessary.

3. If road test is fine, you can now enjoy the added power and performance from your kit.

4. K&N Engineering, Inc., suggests checking the air filter element periodically for excessive dirt build-up. When the element becomes covered in dirt (or once a year), service it according to the instructions on the Recharger® service kit, part number 99-5050 or 99-5000.