

KENWOOD

**DDX793
DDX773BH
DDX593**

**DDX573BH
DDX416BT
DDX393**

**DDX373BT
DDX23BT**

**MONITOR WITH DVD RECEIVER
INSTRUCTION MANUAL**

JVC KENWOOD Corporation



This HD Radio receiver enables:

HD2/HD3

Digital Sound

Program Info



Take the time to read through this instruction manual.

Familiarity with installation and operation procedures will help you obtain the best performance from your new DVD-receiver.

For your records

Record the serial number, found on the back of the unit, in the spaces designated on the warranty card, and in the space provided below. Refer to the model and serial numbers whenever you call upon your Kenwood dealer for information or service on the product.

Model DDX793/DDX773BH/DDX593/DDX573BH/DDX416BT/DDX393/DDX373BT/DDX23BT Serial number _____

US Residents Only

CONTENTS

BEFORE USE	2	OTHER EXTERNAL COMPONENTS	38
How to reset your unit.....	3	Using camera.....	38
INITIAL SETTINGS	4	Using external audio/video players—AV-IN	41
Initial setup.....	4	Using an external component via ADS adapter—	
Setting the security function	4	OEM Features.....	41
Clock settings	5	Using the external navigation unit	42
BASICS	6	BLUETOOTH	43
Component names and functions	6	SETTINGS	51
Common operations.....	8	Settings for using applications of iPod touch/	
Common screen operations.....	9	iPhone/Android/BlackBerry.....	51
Selecting the playback source.....	11	Sound adjustment	52
Using short-cut buttons.....	12	Adjustment for video playback.....	55
DISCS	13	Changing the display design	56
USB	18	Customizing the Home screen.....	57
Android	20	Customizing the system settings	58
iPod/iPhone	22	Setting menu items.....	60
APPS	24	REMOTE CONTROLLER	63
Pandora®	25	CONNECTION/INSTALLATION	66
HD Radio™ tuner	27	REFERENCES	72
RADIO	30	Maintenance	72
SiriusXM® Satellite Radio	32	More information.....	72
		Error message list	76
		Troubleshooting.....	77
		Specifications.....	79

How to read this manual:

- Illustrations of DDX793 are mainly used for explanation. The displays and panels shown in this manual are examples used to provide clear explanations of the operations. For this reason, they may be different from the actual displays or panels.
- This manual mainly explains operations using the buttons on the monitor panel and touch panel. For operations using the remote controller (RC-DV340: supplied only for DDX416BT), see page 63.
- < > indicates the various screens/menus/operations/settings that appear on the touch panel.
- [] indicates the buttons on the touch panel.
- **Indication language:** English indications are used for the purpose of explanation. You can select the indication language from the <Setup> menu. (Page 62)
- Updated information (the latest Instruction Manual, system updates, new functions, etc.).

BEFORE USE

IMPORTANT

To ensure proper use, please read through this manual before using this product. It is especially important that you read and observe WARNINGS and CAUTIONS in this manual. Please keep the manual in a safe and accessible place for future reference.

⚠ **WARNINGS: (To prevent accidents and damage)**

- DO NOT install any unit or wire any cable in a location where;
 - it may obstruct the steering wheel and gearshift lever operations.
 - it may obstruct the operation of safety devices such as air bags.
 - it may obstruct visibility.
- DO NOT operate the unit while driving. If you need to operate the unit while driving, be sure to look around carefully.
- The driver must not watch the monitor while driving.

For DDX416BT:

The marking of products using lasers



The label is attached to the chassis/case and says that the component uses laser beams that have been classified as Class 1. It means that the unit is utilizing laser beams that are of a weaker class. There is no danger of hazardous radiation outside the unit.

BEFORE USE

For DDX793/DDX773BH/DDX593/DDX573BH/
DDX393/DDX373BT/DDX23BT:

⚠ CAUTION

Use of controls or adjustments or performance of procedures other than those specified herein may result in hazardous radiation exposure. In compliance with Federal Regulations, the following are reproductions of labels on, or inside the product relating to laser product safety.

JVC KENWOOD Corporation
2967-3, ISHIKAWA-MACHI, HACHIOJI-SHI, TOKYO, JAPAN

THIS PRODUCT COMPLIES WITH DHHS RULES 21CFR
SUBCHAPTER J IN EFFECT AT DATE OF MANUFACTURE.

Location : Top plate

FCC WARNING

This equipment may generate or use radio frequency energy. Changes or modifications to this equipment may cause harmful interference unless the modifications are expressly approved in the instruction manual. The user could lose the authority to operate this equipment if an unauthorized change or modification is made.

FCC NOTE

This equipment has been tested and found to comply with the limits for a Class B digital device, pursuant to Part 15 of the FCC Rules. These limits are designed to provide reasonable protection against harmful interference in a residential installation.

This equipment may cause harmful interference to radio communications, if it is not installed and used in accordance with the instructions. However, there is no guarantee that interference will not occur in a particular installation. If this equipment does cause harmful interference to radio or television reception, which can be determined by turning the equipment off and on, the user is encouraged to try to correct the interference by one or more of the following measures:

- Reorient or relocate the receiving antenna.
- Increase the separation between the equipment and receiver.
- Connect the equipment into an outlet on a circuit different from that to which the receiver is connected.
- Consult the dealer or an experienced radio/TV technician for help.

For DDX793/DDX773BH/DDX593/DDX573BH/
DDX393/DDX373BT/DDX23BT:
IC (Industry Canada) Notice

This device complies with Industry Canada license-exempt RSS standard(s).

Operation is subject to the following two conditions:

(1) This device may not cause interference, and (2) this device must accept any interference, including interference that may cause undesired operation of the device. The term "IC:" before the certification/registration number only signifies that the Industry Canada technical specification were met.

CAUTION

This equipment complies with FCC/IC radiation exposure limits set forth for an uncontrolled environment and meets the FCC radio frequency (RF) Exposure Guidelines in Supplement C to OET65 and RSS-102 of the IC radio frequency (RF) Exposure rules. This equipment has very low levels of RF energy that it deemed to comply without maximum permissive exposure evaluation (MPE). But it is desirable that it should be installed and operated keeping the radiator at least 20 cm or more away from person's body (excluding extremities: hands, wrists, feet and ankles).

Under Industry Canada regulations, this radio transmitter may only operate using an antenna of a type and maximum (or lesser) gain approved for the transmitter by Industry Canada. To reduce potential radio interference to other users, the antenna type and its gain should be so chosen that the equivalent isotropically radiated power (e.i.r.p.) is not more than that necessary for successful communication.

- Contains Transmitter Module
FCC ID : ZWY8350X (for DDX793/DDX593)/
ZWY8811X (for DDX773BH/DDX573BH/DDX393/
DDX373BT/DDX23BT)
- Contains Transmitter Module
IC: 12033A-8350X (for DDX793/DDX593)/
12033A-8811X (for DDX773BH/DDX573BH/
DDX393/DDX373BT/DDX23BT)

⚠ Cautions on the monitor:

- The monitor built into this unit has been produced with high precision, but it may have some ineffective dots. This is inevitable and is not considered defective.

- Do not expose the monitor to direct sunlight.
- Do not operate the touch panel using a ball-point pen or similar tool with a sharp tip.
Touch the buttons on the touch panel with your finger directly (if you are wearing a glove, take it off).
- When the temperature is very cold or very hot...
 - Chemical changes occur inside, causing malfunction.
 - Pictures may not appear clearly or may move slowly. Pictures may not be synchronized with the sound or picture quality may decline in such environments.

For safety...

- Do not raise the volume level too much, as this will make driving dangerous by blocking outside sounds, and may cause hearing loss.
- Stop the car before performing any complicated operations.

Temperature inside the car...

If you have parked the car for a long time in hot or cold weather, wait until the temperature in the car becomes normal before operating the unit.

❑ How to reset your unit

If the unit fails to operate properly, press the reset button.

DDX793/DDX773BH



DDX593/DDX573BH/DDX416BT/DDX393/ DDX373BT/DDX23BT



INITIAL SETTINGS

Initial setup

When you power on the unit for the first time or reset the unit, the initial setting screen appears.

- You can also change the settings on the **<Setup>** screen. (Page 60)

1 Perform the initial settings.

- Press [**▼**] repeatedly to display more items.



<Demonstration> Activate or deactivate the display demonstration. (Page 61)

<Language> Select the text language used for on-screen information.

- Set **<GUI Language>** to display the operation buttons and menu items in the selected language (**(Local)**) or English (**(English)**).

<Angle>^{*1} Adjust the panel angle. (Page 8)

<iPod Setup> Select the connection method of iPod/iPhone. (Page 22)

<Front Camera>^{*2} Configure the settings to display the picture from the connected front view camera. (Page 38)

<Rear Camera> Configure the settings to display the picture from the connected rear view camera. (Page 38)

<User Customize> Change the display design. (Page 56)

2 Finish the procedure.

- Press [**▼**] repeatedly to change the page on the **<Initial Setup>** screen.



The Home screen is displayed.

*1 Only for DDX793/DDX773BH.

*2 Only for DDX793/DDX773BH/DDX593/DDX573BH/DDX393.

Setting the security function

Registering a security code (only for DDX416BT)

You can set a security code to protect your receiver system against theft.

1 Display the Home screen.

On the monitor panel:



2 Display the **<System>** setting screen.

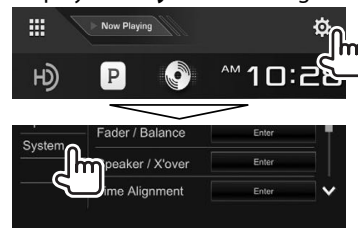

3 Display the **<Security Code Set>** screen.

- Press [**▼**] repeatedly to change the page on the **<System>** menu screen.

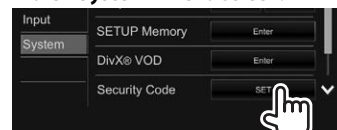

- To clear the registered security code, perform steps 1 and 2, then press [**CLR**] in **<Security Code>**.

4 Enter a four-digit number (①), then confirm the entry (②).



- Press [**Clear**] to delete the last entry.
- Press [**Cancel**] to cancel the setting.
- Press [**X**] to return to the current source control screen.

INITIAL SETTINGS

- Repeat step 4 to confirm your security code.

Now, your security code is registered.

- When the unit has been reset or disconnected from the battery, you are required to enter the security code. Enter the correct security code, then press **[Enter]**.

Activating the security function

You can activate the security function to protect your receiver system against theft.

- Display the **<System>** setting screen. On the Home screen:
 - Press **[V]** repeatedly to change the page on the **<System>** menu screen.

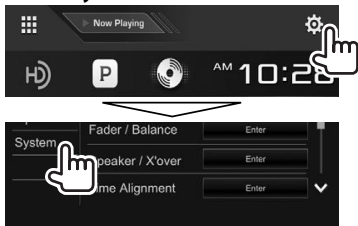

The security indicator on the monitor panel flashes when the vehicle ignition is off.

To deactivate the security function: Select **[OFF]** for **<SI>**.

Clock settings

- Display the Home screen. On the monitor panel:
DDX793/DDX773BH



**DDX593/DDX573BH/
DDX416BT/DDX393/
DDX373BT/DDX23BT**



- Display the **<Clock>** setting screen.

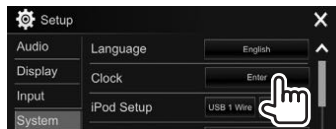
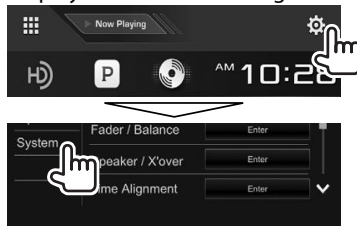

- You can also display the **<Clock>** setting screen by touching the clock area on the Home screen.

- Set the clock time.



- <NAV>*** Synchronizes the clock time with the connected navigation unit.
- <Radio Data System>** Synchronizes the clock time with FM RBDS.
- <OFF>** Sets the clock manually. (See below.)

When selecting **<OFF>**:
Adjust the hour (①), then adjust the minute (②).

- Press **[Reset]** to set the minute to "00".

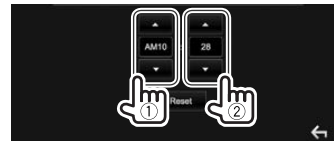

- Finish the procedure.



- * Only for DDX416BT: Appears only when a navigation unit is connected.

BASICS

Component names and functions

⚠ Caution on the volume setting:

Digital devices produce very little noise compared with other sources. Lower the volume before playing these digital sources to avoid damaging the speakers by sudden increase of the output level.

DDX793/DDX773BH

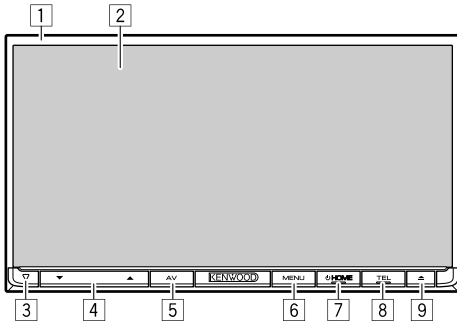

- 1 Monitor panel*
- 2 Screen (touch panel)
- 3 Reset button/Power indicator/Security indicator
 - Resets the unit. (Page 3)
 - Lights up while the unit is turned on.
 - Flashes when the security function is activated. (Page 5)
- 4 VOLUME ▼/▲ buttons
 - Adjusts the audio volume. (Page 8)
- 5 AV/DISP OFF button
 - Displays the current source control screen. (Press)
 - Turns off the screen. (Hold) (Page 9)
- 6 MENU/CAMERA button
 - Pops up the short-cut menu. (Press) (Page 12)
 - Displays the picture from the connected camera. (Hold) (Page 39)
- 7 HOME button
 - Displays the Home screen. (Press) (Page 10)
 - Turns on the power. (Press) (Page 8)
 - Turns off the power. (Hold) (Page 8)
- 8 TEL/VOICE button
 - Displays the phone control screen. (Press) (Page 47)
 - Activates voice dialing. (Hold) (Page 48)
- 9 ▲ (Eject) button
 - Ejects the disc. (Tilts the monitor panel fully.)
 - Opens/closes the monitor panel.

* You can change the color of the buttons on the monitor panel. (Page 56)

BASICS

DDX593/DDX573BH/DDX393/DDX373BT/ DDX23BT

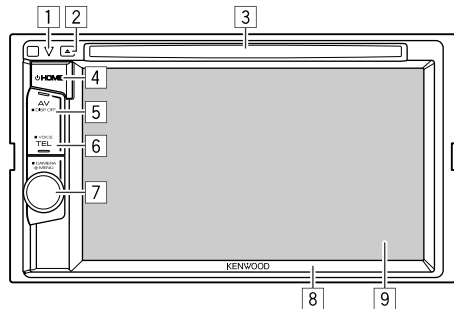

- 1 Reset button/Power indicator/Security indicator
 - Resets the unit. (Page 3)
 - Lights up while the unit is turned on.
 - Flashes when the security function is activated. (Page 5)
- 2 ▲ (Eject) button
 - Ejects the disc.
- 3 Loading slot
- 4 ⏻ HOME button
 - Displays the Home screen. (Press) (Page 10)
 - Turns on the power. (Press) (Page 8)
 - Turns off the power. (Hold) (Page 8)
- 5 AV/DISP OFF button
 - Displays the current source control screen. (Press)
 - Turns off the screen. (Hold) (Page 9)

- 6 TEL/VOICE button
 - Displays the phone control screen. (Press) (Page 47)
 - Activates voice dialing. (Hold) (Page 48)
- 7 Volume/MENU/CAMERA knob
 - Adjusts the audio volume. (Turn) (Page 8)
 - Pops up the short-cut menu. (Press) (Page 12)
 - Displays the picture from the connected camera. (Hold) (Page 39)
- 8 Monitor panel*
- 9 Screen (touch panel)

* You can change the color of the buttons on the monitor panel. (Page 56)

DDX416BT

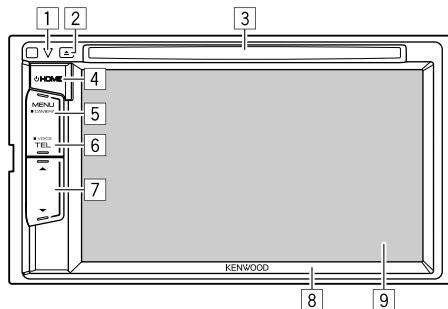

- 1 Reset button/Power indicator/Security indicator
 - Resets the unit. (Page 3)
 - Lights up while the unit is turned on.
 - Flashes when the security function is activated. (Page 5)
- 2 ▲ (Eject) button
 - Ejects the disc.
- 3 Loading slot
- 4 ⏻ HOME button
 - Displays the Home screen. (Press) (Page 10)
 - Turns on the power. (Press) (Page 8)
 - Turns off the power. (Hold) (Page 8)
- 5 MENU/CAMERA button
 - Pops up the short-cut menu. (Press) (Page 12)
 - Displays the picture from the connected camera. (Hold) (Page 39)
- 6 TEL/VOICE button
 - Displays the phone control screen. (Press) (Page 47)
 - Activates voice dialing. (Hold) (Page 48)
- 7 Volume ▼/▲ buttons
 - Adjusts the audio volume. (Page 8)
- 8 Monitor panel*
- 9 Screen (touch panel)

* You can change the color of the buttons on the monitor panel. (Page 56)

BASICS

Common operations

❑ Turning on the power
DDX793/DDX773BH



DDX593/DDX573BH/
DDX416BT/DDX393/
DDX373BT/DDX23BT

❑ Turning off the power
DDX793/DDX773BH

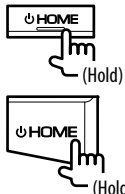

DDX593/DDX573BH/
DDX416BT/DDX393/
DDX373BT/DDX23BT

❑ Adjusting the volume

To adjust the volume (00 to 35)
DDX793/DDX773BH

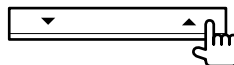

DDX416BT

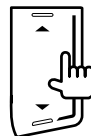

Press ▲ to increase, and press ▼ to decrease.

- Holding the button increases/decreases the volume continuously.

DDX593/DDX573BH/
DDX393/DDX373BT/
DDX23BT



Turn to the right to increase, and turn to the left to decrease.

❑ Adjusting the panel angle (only for
DDX793/DDX773BH)

1 Display the <Angle Adjust> screen.

On the Home screen:

- Press [▼] repeatedly to change the page on the <Display> menu screen.

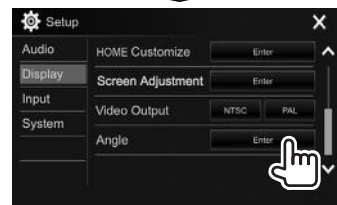
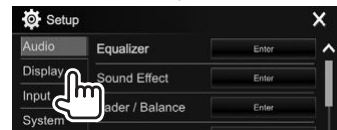
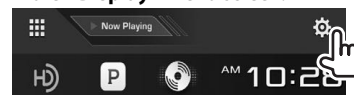

2 Select an angle (0 – 6).



- To set the current position as the power off position, select [Memory].

BASICS

❑ Putting the unit in standby

- 1 Display all playback sources and items.
On the Home screen:

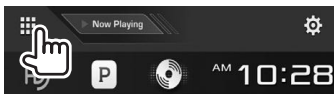

2

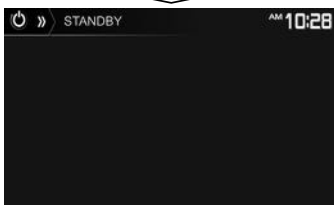
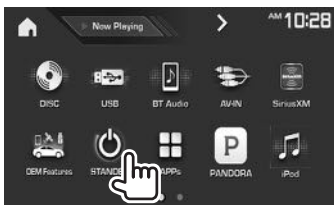

❑ Turning off the screen

On the pop-up short-cut menu (Page 12):
Display the pop-up short-cut menu by pressing MENU on the monitor panel, then select **[Display OFF]**.



On the monitor panel (only for DDX793/DDX773BH/
DDX593/DDX573BH/DDX393/DDX373BT/DDX23BT):
DDX793/DDX773BH

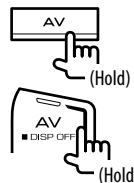

**DDX593/DDX573BH/
DDX393/DDX373BT/
DDX23BT**

To turn on the screen: Press and the hold the same button, or touch the display.

Common screen operations

❑ Common screen descriptions

You can display other screens at any time to change the source, show the information, or change the settings, etc.

Source control screen

Performs source playback operations.

- The operation buttons and information displayed vary depending on the selected source.

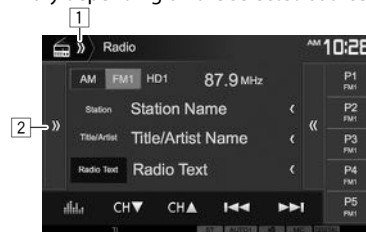

Common operating buttons:

- 1 Displays/hides short-cut source selection buttons. (Page 12)
- 2 Displays the other operation button window.*

* Does not appear when there are no other operation buttons other than those currently shown on the source control screen.

BASICS

Home screen

Displays the source control screen and settings screen.

- You can arrange the items to display on the Home screen. (Page 57)



Common operating buttons:

- 1 Displays all playback sources and items. (Page 11)
- 2 Displays the source currently played back.
- 3 Displays the <Setup> screen. (See the right column.)
- 4 Changes the playback source. (Page 11)
- 5 Displays the <Clock> setting screen. (Page 5)

<Setup> screen

Changes the detailed settings. (Page 60)

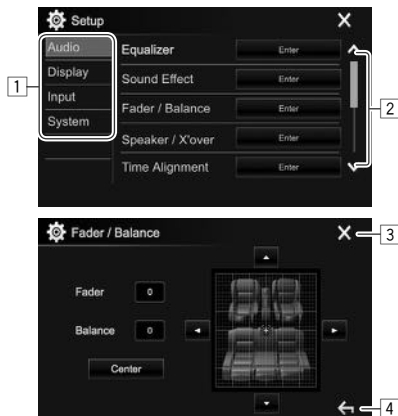

Common operating buttons:

- 1 Selects the menu category.
- 2 Changes the page.
- 3 Closes the current setting screen and returns to the current source control screen.
- 4 Returns to the previous screen.

Touch screen operations

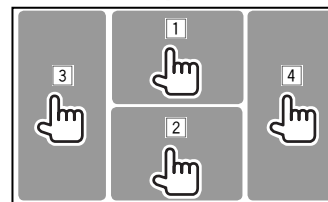

- 1 Displays the video control menu while playing a video.



- 2 Displays the source control screen while playing a video.



- The operation buttons disappear when the screen is touched or when no operation is done for about 5 seconds.

- 3 Goes to the previous chapter/track.*
- 4 Goes to the next chapter/track.*

* Not available for video from an external component.

BASICS

Selecting the playback source

On the Home screen:

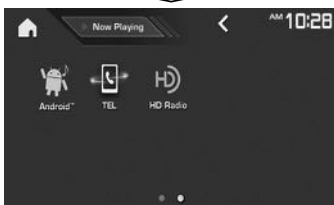
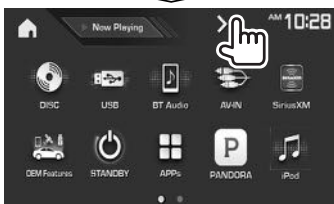
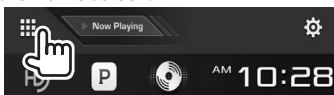

- You can change the page to display more items by pressing [**◀**]/[**▶**].
 - The current page is indicated by the page indicator at the bottom of the screen.

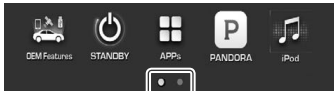

[NAV]*¹

Displays the navigation screen when a navigation unit is connected. (Page 42)
Plays a disc. (Page 13)

[DISC]

[USB]

Plays files on a USB device. (Page 18)

[BT Audio]

Plays a Bluetooth audio player. (Page 49)

[AV-IN]*²

Switches to an external component connected to the iPod/AV-IN input terminal. (Page 41)

[SiriusXM]*³

Switches to the SiriusXM® radio broadcast. (Page 32)

[OEM Features]*⁴

Switches to the source connected via ADS adapter. (Page 41)

[STANDBY]

Puts the unit in standby. (Page 9)

[APPS]

Switches to the App screen from the connected iPod touch/iPhone/Android/BlackBerry device. (Page 24)

[PANDORA]*⁵

Switches to the Pandora broadcast. (Page 25)

[iPod]

[Android™]

Plays an iPod/iPhone. (Page 22)
Plays an Android device. (Page 20)

[TEL]

Displays the phone control screen. (Page 47)

[HD Radio]*⁶

Switches to the HD Radio broadcast. (Page 27)

[Radio]*⁷

Switches to the conventional radio broadcast. (Page 30)

To return to the Home screen

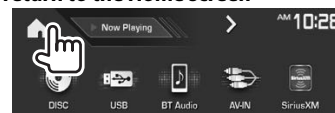

*¹ Only for DDX416BT: When no navigation unit is connected, "No Navigation" appears.

*² Selectable only when <iPod Setup> is set to [USB 1 Wire]. (Page 22)

*³ Only for DDX793/DDX773BH/DDX593/DDX573BH/DDX393/DDX373BT.

*⁴ Only for DDX793/DDX773BH/DDX593/DDX573BH/DDX393.

*⁵ Only for DDX793/DDX773BH/DDX593/DDX573BH/DDX393/DDX373BT/DDX23BT.

*⁶ Only for DDX793/DDX773BH/DDX593/DDX573BH.

*⁷ Only for DDX416BT/DDX393/DDX373BT/DDX23BT.

☐ Selecting the playback source on the Home screen



- You can change the items to display on the Home screen. (Page 57)

BASICS

Using short-cut buttons

Using short-cut source selection buttons

While displaying the source control screen, you can use the short-cut buttons to go to the items on the Home screen indicated below.

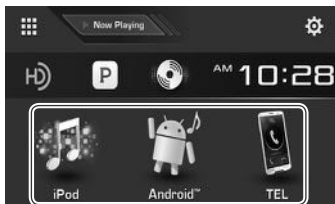

To display the short-cut source selection buttons

On the source control screen:



To hide the short-cut buttons



Using the pop-up short-cut menu

While displaying the source control screen, you can jump to the other screen from the pop-up short-cut menu.

- 1 Display the pop-up short-cut menu.

DDX793/DDX773BH



**DDX593/DDX573BH/
DDX393/DDX373BT/
DDX23BT**



DDX416BT



- 2 Select an item to jump to.

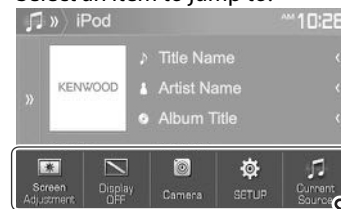

[Screen Adjustment] Displays the picture adjustment screen. (Page 55)

[Display OFF] Turns off the screen. (Page 9)

[Camera] Displays the picture from the connected camera. (Page 39)

[SETUP] Displays the <Setup> screen. (Page 60)

[Current Source] Displays the current source control screen.

To close the pop-up menu: Touch the screen anywhere other than the pop-up short-cut menu.

DISCS

Playing a disc

- If a disc does not have a disc menu, all tracks on it will be played repeatedly until you change the source or eject the disc.
- For playable disc types/file types, see page 73.

❑ Inserting a disc

Insert a disc with the label side facing up.

DDX793/DDX773BH

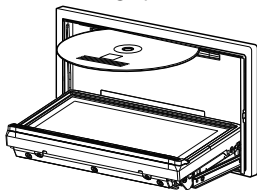
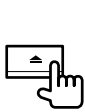

**DDX593/DDX573BH/
DDX393/DDX373BT/
DDX23BT**

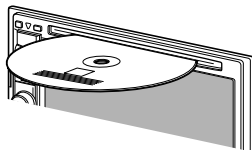

DDX416BT

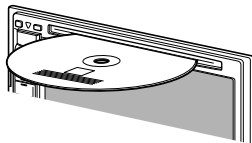

The source changes to "DISC" and playback starts.

- The IN indicator lights up while a disc is inserted.

- If "⊘" appears on the screen, the unit cannot accept the operation you have tried to do.
 - In some cases, without showing "⊘," operations will not be accepted.
- When playing back a multi-channel encoded disc, the multi-channel signals are downmixed to stereo.

❑ Ejecting a disc DDX793/DDX773BH



**DDX593/DDX573BH/DDX416BT/
DDX393/DDX373BT/DDX23BT**

- When removing a disc, pull it horizontally.
- You can eject a disc when playing another AV source.
- If the ejected disc is not removed within 15 seconds, the disc is automatically inserted again into the loading slot to protect it from dust.

Closing the monitor panel (only for DDX793/ DDX773BH)

After removing the disc, press ▲ on the monitor panel. The monitor panel closes.

Playback operations

- When the operation buttons are not displayed on the screen, touch the area shown on the illustration.
- To change settings for video playback, see page 55.

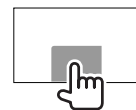

❑ Indications and buttons on the source control screen

For video playback

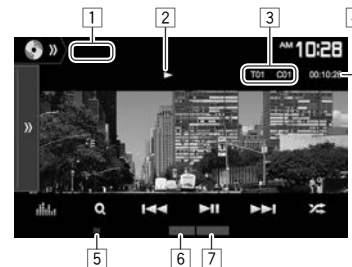

Playback information

- The information displayed on the screen differs depending on the type of disc/file being played back.
- 1 Media type
 - 2 Playback status
 - 3 Current playback item information (title no./chapter no./folder no./file no./track no.)
 - 4 Playing time
 - 5 IN indicator
 - 6 Playback mode (Page 16)
 - 7 File type

Continued on the next page...

DISCS

Operation buttons

- Available buttons on the screen and operations differ depending on the type of disc/file being played back.

[>>] Displays the other operation button window.

- To hide the window, press [≪≪].

[EQ] Displays the <Equalizer> screen. (Page 52)

[Q] Displays the folder/track list. (Page 15)

[◀◀] [▶▶] • Selects a chapter/track. (Press)
• Reverse/forward search. (Hold)
• Plays in slow-motion during pause. (Hold)

[▶▶] Starts/pauses playback.

[X] Selects Random playback mode. (Page 16)

[📁] [➕] Selects a folder.

[🔄] Selects Repeat playback mode. (Page 16)

[■] Stops playback.

[MODE] Changes the settings for disc playback on the <DISC Mode> screen. (Page 17)

- To display all available operation buttons, press [>>] to display the other operation button window.

For audio playback



Playback information

- The information displayed on the screen differs depending on the type of disc/file being played back.

- 1 Media type
- 2 Track/file information
 - Pressing [◀] scrolls the text if not all of the text is shown.
- 3 Playing time
- 4 IN indicator
- 5 Playback status
- 6 Playback mode (Page 16)
- 7 File type
- 8 Current playback item information (folder no./file no./track no.)

Operation buttons

- Available buttons on the screen and operations differ depending on the type of disc/file being played back.

[>>] Displays the other operation button window.

- To hide the window, press [≪≪].

[EQ] Displays the <Equalizer> screen. (Page 52)

[Q] Displays the folder/track list. (Page 15)

[◀◀] [▶▶] • Selects a track. (Press)
• Reverse/forward search. (Hold)

[▶▶] Starts/pauses playback.

[■] Stops playback.

[X] Selects Random playback mode. (Page 16)

[📁] [➕] Selects a folder.

[🔄] Selects Repeat playback mode. (Page 16)

[MODE] Changes the settings for disc playback on the <DISC Mode> screen. (Page 17)

- To display all available operation buttons, press [>>] to display the other operation button window.

DISCS

❑ Selecting a folder/track on the list

1



2 Select the folder (①), then the item in the selected folder (②).

- Repeat the procedure until you select the desired track.



- You can change the page to display more items by pressing [▲]/[▼].
- Press [⏪] to return to the root folder.
- Press [⏩] to return to the upper layer.
- If you want to play all tracks in the folder, press [▶] on the right of the desired folder.

❑ Video menu operations

You can display the video menu screen during video playback.

- The operation buttons disappear when the screen is touched or when no operation is done for about 5 seconds.

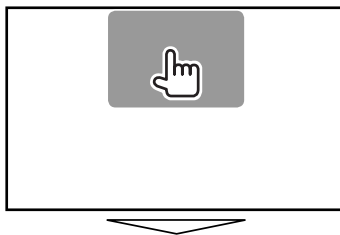

For video playback except VCD



- Available buttons on the screen and operations differ depending on the type of disc/file being played back.

[MENU]
[T MENU]
[Highlight]

Displays the disc menu (DVD).
Displays the disc menu (DVD).
Switches to the direct disc menu to select.

- To restore the screen, press [←].

[CUR]

Displays the menu/scene selection screen.

- [▲] [▼] [◀] [▶]: Selects an item.
- [Enter]: Confirms the selection.
- [Return]: Returns to the previous screen.

[ZOOM]

Displays the picture size selection screen. (Page 56)

[Aspect]

Selects the aspect ratio. (Page 55)

[PictureAdjust]

Displays the picture adjustment screen. (Page 55)

[Audio]

Selects the audio type.

[Subtitle]

Selects the subtitle type.

[Angle]

Selects the view angle.

DISCS

For VCD



[MENU]

Displays the disc menu.

[Audio]

Selects the audio channel (ST: stereo, L: left, R: right).

[Direct]

Displays/hides the direct selection buttons. (See the right column.)

[Return]

Displays the previous screen or menu.

[ZOOM]

Displays the picture size selection screen. (Page 56)

[Aspect]

Selects the aspect ratio. (Page 55)

[PictureAdjust]

Displays the picture adjustment screen. (Page 55)

To select a track directly on a VCD

- When playing a VCD with PBC activated, stop playback to deactivate the PBC function, then use the direct selecting buttons to select a track number.

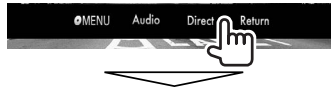

- When you enter a wrong number, press **[DIR/CLR]** to delete the last entry.

Selecting playback mode

To select Repeat playback mode

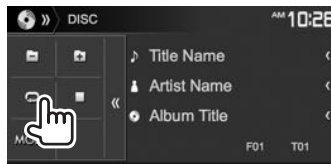
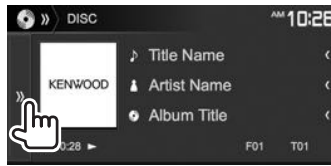

To select Random playback mode



- The location of the buttons differ depending on the type of disc/file being played back.
 - When **[]** is not displayed, display the other operation button window by pressing **[]**.
- Available playback modes differ depending on the type of disc/file being played back.
- You cannot activate the repeat mode and the random mode at the same time.
- Each time you press the button, the playback mode changes. (The corresponding indicator lights up.)
 - Available items differ depending on the type of disc/file being played back.

C-REP

Repeats current chapter.

T-REP

Repeats current title/program.

REP

Repeats current track.

FO-REP

Repeats all tracks of the current folder.

FO-RDM

Randomly plays all tracks of the current folder, then tracks of the next folders.

RDM

Randomly plays all tracks.

To cancel Repeat/Random playback: Press the button repeatedly until the indicator disappears.

DISCS

Settings for disc playback—<DISC Mode>

1

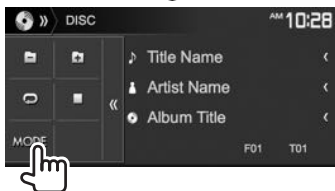
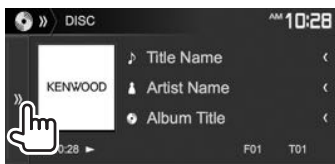

2



- Available items shown on the <DISC Mode> screen differ depending on the type of disc/file being played back.

Setting items

<Menu Language>	Select the initial disc menu language. (Initial: English) (Page 75)
<Subtitle Language>	Select the initial subtitle language or turn subtitles off (Off). (Initial: English) (Page 75)
<Audio Language>	Select the initial audio language. (Initial: English) (Page 75)
<Dynamic Range Control>	You can change the dynamic range while playing using Dolby Digital software. <ul style="list-style-type: none"> • Wide: Select this to enjoy a powerful sound at a low volume level with its full dynamic range. • Normal: Select this to reduce the dynamic range a little. • Dialog (Initial): Select this to reproduce movie dialog more clearly.

<Down Mix>	When playing back a multi-channel disc, this setting affects the signals reproduced through the front and/or rear speakers. <ul style="list-style-type: none"> • Dolby Surround: Select this to enjoy multi-channel surround sound by connecting an amplifier compatible with Dolby Surround. • Stereo (initial): Normally select this.
<Screen Ratio>	Select the monitor type to watch a wide screen picture on the external monitor. <p>16:9 (Initial) 4:3 LB 4:3 PS</p> 
<File Type>*	Select the playback file type when a disc contains different types of files. <ul style="list-style-type: none"> • Audio: Plays back audio files. • Still Image: Plays back picture files. • Video: Plays back video files. • Audio&Video (initial): Plays back audio files and video files.

- * For playable file types, see page 73.
- If the disc contains no files of the selected type, the existing files are played in the following priority: audio, video, then still picture. You can change these settings only while playback is stopped.

USB

Connecting a USB device

You can connect a USB mass storage class device such as a USB memory, Digital Audio Player etc. to the unit.

- For details about connecting USB devices, see page 69.
- You cannot connect a computer or portable HDD to the USB input terminal.
- For playable file types and notes on using USB devices, see page 74.

When a USB device is connected...

The source changes to “USB” and playback starts.

- All tracks in the USB device will be played repeatedly until you change the source.

To disconnect the USB device safely:

Press [▲], then disconnect the USB device after “No Device” appears.

Playback operations

When the operation buttons are not displayed on the screen, touch the area shown on the illustration.

- To change settings for video playback, see page 55.

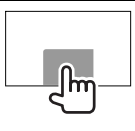

Indications and buttons on the source control screen



Playback information

- The information displayed on the screen differs depending on the type of file being played back.
- 1 Jacket picture (Shown while playing if the file has tag data that includes the jacket picture)
 - 2 Track/file information
 - Pressing [◀] scrolls the text if not all of the text is shown.
 - 3 Playing time
 - 4 Playback status
 - 5 Playback mode (See the right column.)
 - 6 File type
 - 7 Current playback item information (folder no./file no.)

Operation buttons

- Available buttons on the screen and operations differ depending on the type of file being played back.

[>>>] Displays the other operation button window.

- To hide the window, press [◀◀].

[📊] Displays the <Equalizer> screen. (Page 52)

[Q] Displays the folder/track list. (Page 19)

[◀◀] [▶▶] • Selects a track. (Press)
• Reverse/forward search. (Hold)

▶||| Starts/pauses playback.

[🔀] Selects random playback mode.*1 *2

- **FO-RDM:** Randomly plays all tracks/files in the folder.
- **RDM:** Randomly plays all tracks/files.

[📁] [➕] Selects a folder.

[🔄] Selects repeat playback mode.*1 *2

- **REP:** Repeats the current track/file.
- **FO-REP:** Repeats all tracks/files in the current folder.

[▲] Disconnects the USB device safely.

[MODE] Changes the settings for USB playback on the <USB Mode> screen. (Page 19)

- To display all available operation buttons, press [>>>] to display the other operation button window.

*1 To cancel random or repeat mode, press the button repeatedly until the indicator disappears.

*2 You cannot activate the repeat mode and the random mode at the same time.

USB

❑ Settings for USB playback—<USB Mode>

1

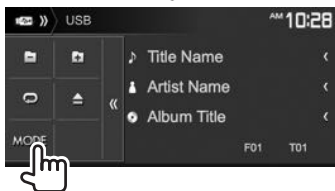
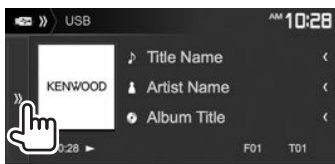

2

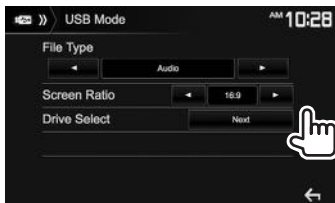

<File Type>* Select the playback file type when a disc contains different types of files.

- **Audio:** Plays back audio files.
- **Still Image:** Plays back picture files.
- **Video:** Plays back video files.
- **Audio&Video (initial):** Plays back audio files and video files.

<Screen Ratio> Select the monitor type to watch a wide screen picture on the external monitor.

16:9 (Initial) 4:3 LB 4:3 PS

<Drive Select> Switches between internal memory and the memory source of the connected device (such as mobile phone). Press [**Next**].

* For playable files, see page 74. If the USB device contains no files of the selected type, the existing files are played in the following priority: audio, video, then still picture.

❑ Selecting a folder/track on the list

1

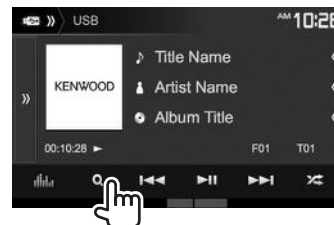

2 Select the folder (①), then the item in the selected folder (②).

• Repeat the procedure until you select the desired track.



- You can change the page to display more items by pressing [**▲**]/[**▼**].
- Press [**⏪**] to return to the root folder.
- Press [**⏩**] to return to the upper layer.
- If you want to play all tracks in the folder, press [**▶**] on the right of the desired folder.

Android

Preparation

❑ Installing KENWOOD Music Play

Install the Android™ application KENWOOD Music Play on your Android device beforehand.

- When a compatible Android device is connected, "Press [VIEW] to install KENWOOD MUSIC PLAY APP" is shown on the Android device. Follow the instructions to install the application. You can also install the latest version of the KENWOOD Music Play application on your Android device before connecting.

About KENWOOD Music Play

- This unit supports the Android™ application KENWOOD Music Play.
- When you use KENWOOD Music Play, you can search for audio files by Genre, Artist, Album, Playlist, and Song.
- KENWOOD Music Play is available on the following.

❑ Connecting an Android device

Connect an Android device with a cable.

- For details about connecting Android devices, see page 69.

Compatible Android device

- This unit supports Android OS 4.1 and above.
- Some Android devices (with OS 4.1 and above) may not fully support Android Open Accessory (AOA) 2.0.
- If the Android device supports both mass storage class device and AOA 2.0, this unit always plays back via AOA 2.0 as priority.

❑ Starting playback

- 1 Start KENWOOD Music Play on your Android device.
- 2 Select "Android™" as the source. (Page 11)

Playback operations

❑ Indications and buttons on the source control screen

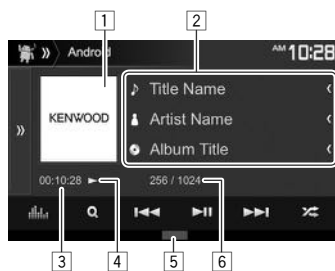

Playback information

- 1 Artwork (Shown if the song contains artwork)
- 2 Track information
 - Pressing [←] scrolls the text if not all of the text is shown.
- 3 Playing time
- 4 Playback status
- 5 Playback mode (See the right column.)
- 6 Track no./Total track number

Operation buttons

- [>>]) Displays the other operation button window.
 - To hide the window, press [≪≪].
- [EQ] Displays the <Equalizer> screen. (Page 52)
- [Q] Displays the track list. (Page 21)
- [|<<<] [>>>|] Selects a track. (Press)
 - Reverse/forward search. (Hold)
- [▶||] Starts/pauses playback.
- [X] Selects random playback mode.*
 - X: Randomly plays all tracks.
 - X Album: Randomly plays all tracks in the current album.
- [O] Selects repeat playback mode.
 - O ①: Repeats the current track.
 - O All: Repeats all tracks.
 - O: Cancels the repeat mode.
- [MODE] Changes the settings for Android playback on the <Android Mode> screen. (Page 21)

- To display all available operation buttons, press [>>]) to display the other operation button window.

* To cancel random mode, press the button repeatedly until the indicator disappears.

Android

❑ Selecting a track from the menu

1

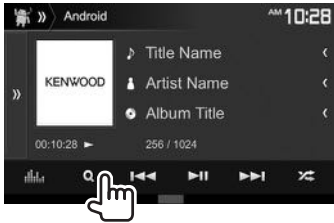

2 Select a category (①), then a desired item (②).

- Select an item in each layer until you reach and select the desired file.
- You can change the page to display more items by pressing [▲]/[▼].
- Press [⏪] to return to the top layer.
- Press [⏩] to return to the upper layer.



❑ Settings for playback on the Android device—<Android Mode>

1

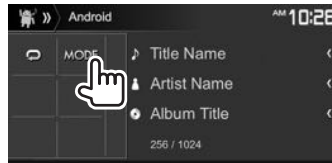
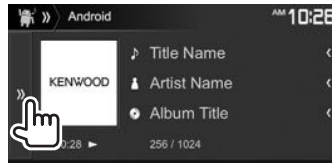

2

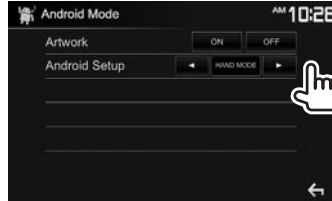

<Artwork>	Shows/hides artwork of the Android device.
<Android Setup>	<ul style="list-style-type: none"> • BROWSE MODE: Controls from the unit (using the KENWOOD Music Play application). • HAND MODE: Controls other media player applications from the Android device (without using the KENWOOD Music Play application). <ul style="list-style-type: none"> – You can play/pause or skip files from the unit.

iPod/iPhone

Preparation

❑ Connecting iPod/iPhone

- For details about connecting iPod/iPhone, see page 69.
- For playable iPod/iPhone types, see page 74.

Connect your iPod/iPhone according to your purpose or the type of iPod/iPhone.

- **To listen to music:** Use USB Audio cable for iPod/iPhone.
 - For Lightning connector models: KCA-iP103 (optional accessory)
 - For 30-pin connector models: KCA-iP102 (optional accessory)
- **To watch video and listen to music (only for 30-pin connector models):** Use USB Audio and Video cable for iPod/iPhone—KCA-iP202 (optional accessory).
 - For Lightning connector models: You cannot watch video with KCA-iP202.

❑ Selecting the connection method of iPod/iPhone

- 1 Putting the unit in standby. (page 9)
- 2 Display the <System> setting screen.
On the Home screen:

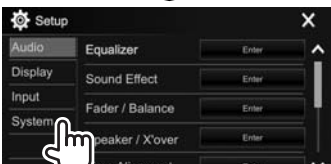

3



- [**USB 1 Wire**] Select this when the iPod/iPhone is connected using KCA-iP102 or KCA-iP103 (optional accessory).
- [**USB+AV-IN**] Select this when the iPod/iPhone is connected using KCA-iP202 (optional accessory).

❑ Selecting preference settings for iPod/iPhone playback—<iPod Mode>

1

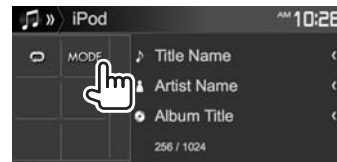
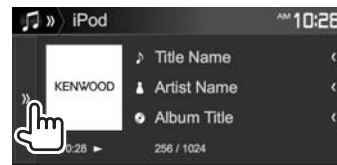

2

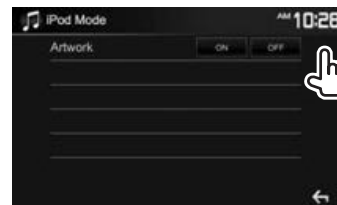

<**Artwork**> Shows/hides artwork of iPod.

iPod/iPhone

Playback operations

When the operation buttons are not displayed on the screen, touch the area shown on the illustration.

- To change settings for video playback, see page 55.

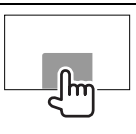

Indications and buttons on the source control screen

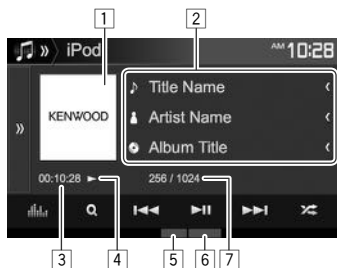

Playback information

- 1 Artwork (Shown if the song contains artwork)
- 2 Song/video information
 - Pressing [**<**] scrolls the text if not all of the text is shown.
- 3 Playing time
- 4 Playback status
- 5 Playback mode (See the right column.)
- 6 File type
- 7 Track no./Total track number

Operation buttons

- [>>] Displays the other operation button window.
 - To hide the window, press [**<<<**].
- [**EQ**] Displays the **<Equalizer>** screen. (Page 52)
- [**Q**] Displays the audio/video file list. (See the right column.)
- [**<<<**] [**>>>**] Selects a track. (Press)
 - Reverse/forward search. (Hold)
- [**||**] Starts/pauses playback.
- [**↻**] Selects random playback mode.*
 - **↻**: Functions the same as Shuffle Songs.
 - **↻ Album**: Functions the same as Shuffle Albums.
- [**🔄**] Selects repeat playback mode.
 - **🔄 1**: Functions the same as Repeat One.
 - **🔄 All**: Functions the same as Repeat All.
 - **🔄**: Cancels the repeat mode.
- [**MODE**] Changes the settings for iPod/iPhone playback on the **<iPod Mode>** screen. (Page 22)

- To display all available operation buttons, press [**>>>**] to display the other operation button window.

* To cancel random mode, press the button repeatedly until the indicator disappears.

Selecting an audio/video file from the menu

- 1 
- 2 Select the menu (**📁**): audio or **📺**: video (1), a category (2), then a desired item (3).
 - Select an item in each layer until you reach and select the desired file.
 - You can change the page to display more items by pressing [**▲**]/[**▼**].
 - Press [**📁**] to return to the top layer.
 - Press [**📺**] to return to the upper layer.
 - If you want to play all tracks in the item, press [**▶**] on the right of the desired item.

Audio menu:

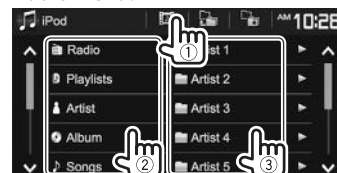

Video menu:

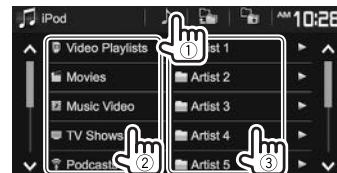

- Available categories differ depending on the type of your iPod/iPhone.

APPS

You can use an App of the connected iPod touch/iPhone/Android/BlackBerry on this unit.

Preparation

- 1 Connect the iPod touch/iPhone/Android/BlackBerry.
 - **For Android/BlackBerry:** Connect the Android/BlackBerry device via Bluetooth. (Page 43)
 - **For iPod touch/iPhone:** Connect iPod touch/iPhone with a cable. (Page 69)
 - Be sure to select the appropriate connection method of iPod touch/iPhone on **<iPod Setup>**. (Page 22)
 - You cannot watch video when connecting a Lightning connector model.
- 2 Select the iPod touch/iPhone/Android/BlackBerry device to use on the **<APP Setup>** screen. (Page 51)

When connecting the device for the first time, the setup screen (for connection, etc.) appears. Follow the procedure on the setup screen to configure the settings.

Using an App

When the operation buttons are not displayed on the screen, touch the screen to show them.

- To change settings for video playback, see page 55.

Playback operations

- 1 Start the App on your iPod touch/iPhone/Android/BlackBerry.
- 2 Select **"Apps"** as the source. (Page 11)

Operation buttons on the source control screen

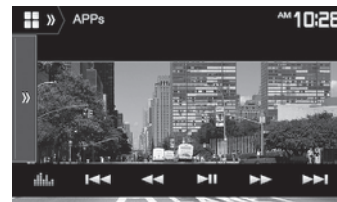

[>>] Displays the other operation button window.

- To hide the window, press [≪≪].

[Equalizer] Displays the **<Equalizer>** screen. (Page 52)

[<<<] [>>>] Selects an audio/video file.

[<<<] [>>>] Reverse/forward search.

[▶||] Starts/pauses playback.

[▶] Starts playback.

[||] Pauses playback.

[0% / 🔊] Switches the device between iPod touch/iPhone connected with a cable and Android/BlackBerry device connected via Bluetooth.

- To display all available operation buttons, press [>>] to display the other operation button window.
- You can operate some functions of the App on the touch panel.
- You can also play back the audio (for iPod touch/iPhone/Android/BlackBerry device) and video (for iPod touch/iPhone) on the stated devices itself, instead of the unit.

You can stream Pandora from iPod touch/iPhone, Android or BlackBerry devices.

- Install the latest version of the Pandora application on your iPod touch/iPhone/Android/BlackBerry.

Preparation

- 1 Connect the device.
 - **For Android/BlackBerry:** Connect the Android/BlackBerry device via Bluetooth. (Page 43)
 - **For iPod touch/iPhone:** Connect iPod touch/iPhone with a cable. (Page 69)
 - Be sure to select the appropriate connection method of iPod touch/iPhone on **<iPod Setup>**. (Page 22)
- 2 Select the device to use on the **<APP Settings>** screen. (Page 51)
- 3 Select **"PANDORA"** as the source. (Page 11)

The Pandora application is started.

 - If the device selection screen is displayed, select the device to use. (Page 51)

Playback operations

You can operate Pandora using the remote controller*. Only playing, pausing, and skipping are available.

Indications and buttons on the source control screen



Playback information

- 1 Picture data
- 2 Track information
 - Pressing [**<**] scrolls the text if not all of the text is shown.
- 3 Playing time
- 4 Playback status

Operation buttons

- [>>] Displays the other operation button window.
 - To hide the window, press [**<<<**].
 - [📊] Displays the **<Equalizer>** screen. (Page 52)
 - [Q] Displays the list selection screen. (Page 26)
 - [👍] Thumbs down to the current track and skips to the next track.
 - [👎] Registers the current track as a favorite.
 - [⏮] Starts/pauses playback.
 - [⏭] Skips the current track.
 - Not available when the Pandora skip reaches its limit.
 - [👤+] Adds the current artist to the Station List.
 - [🎵+] Adds the current track to the Station List.
 - [🔖] Bookmarks the current track.
 - [📶/📱] Switches the device between iPod touch/iPhone connected with a cable and Android/BlackBerry device connected via Bluetooth.
- To display all available operation buttons, press [**>>>**] to display the other operation button window.

* Purchase KNA-RCDV331 separately.

Pandora®

❑ Selecting a station from the list

1 Display the list selection screen.



2 Select the list type.



<Station List> Selects from the station names (Station List).

<Genre List> Selects from the genre names (Genre List).

3 Select a station from the list.

On the Station List

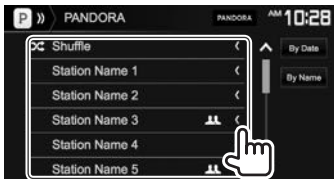

[Shuffle] Plays all the songs in the registered stations randomly.

[By Date] Sorts the list in reverse chronological order.

[By Name] Sorts the list in alphabetical order.

- You can change the page to display more items by pressing [**▲**]/[**▼**].
- The **SC** indicator appears on the left of the item when Shuffle is activated. (All songs in the registered stations are played randomly.)
- The **||** indicator appears on the right of the item when the station is shared.

On the Genre List

Select a genre (①), then a station (②).

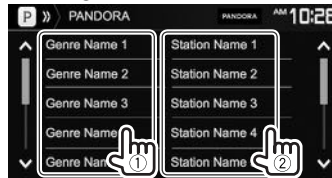

- You can change the page to display more items by pressing [**▲**]/[**▼**].
- The selected station is added to the Station List.

Requirements for Pandora®

iPhone or iPod touch

- Install the latest version of the Pandora application on your iPhone or iPod touch. (Search for "Pandora" in the Apple iTunes App Store to find and install the most recent version.)
- Connect iPod touch/iPhone to this unit with KCA-iP202, KCA-iP102 or KCA-iP103 (optional accessory).

Android™

- Visit Google play and search for "Pandora" to install.
- Bluetooth must be built in and the following profiles must be supported.
 - SPP (Serial Port Profile)
 - A2DP (Advanced Audio Distribution Profile)

BlackBerry®

- Bluetooth must be built in and the following profiles must be supported.
 - SPP (Serial Port Profile)
 - A2DP (Advanced Audio Distribution Profile)

NOTE

- Ensure you are logged in to your smartphone application. If you do not have a Pandora account, you can create one for free from your smartphone.
- Pandora is only available in certain countries.
- Because Pandora is a third-party service, the specifications are subject to change without prior notice. Accordingly, compatibility may be impaired or some or all of the services may become unavailable.
- Some functions of Pandora cannot be operated from this unit.
- Establish an Internet connection using LTE, 3G, EDGE, or WiFi.

HD Radio™ tuner (Only for DDX793/DDX773BH/DDX593/DDX573BH)

About HD Radio™ Technology

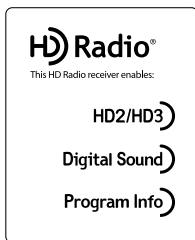

HD2/HD3

- Adjacent to traditional main stations are HD2/HD3 Channels, providing new original programming on the FM dial

Digital Sound

- Crystal clear, CD-like digital audio quality to consumers; eliminates background noise

Program Info

- Provides song name, artist, station ID, and other relevant data to enrich the listening experience

Listening to an HD Radio™ broadcast

Indications and buttons on the source control screen

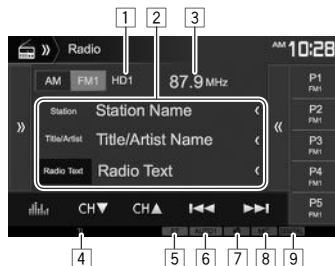

HD Radio reception information

- 1 Channel no.
- 2 Text information
 - Pressing [**<**] scrolls the text if not all of the text is shown.
 - Pressing [**Radio Text**] switches the information between Radio Text, Message, PTY code and Station Name.
- 3 The station frequency currently tuned in
- 4 TI indicator

- 5 ST indicator: Lights up when receiving an FM stereo broadcast with sufficient signal strength.
- 6 Seek mode
- 7 HD indicator: Lights up when receiving an HD Radio broadcast.
- 8 MC indicator: Lights up when receiving an HD Radio multicast channel.
- 9 HD Radio reception mode (Page 28)
 - When digital signals are emitted, the DIGITAL indicator lights up.
 - When analog signals are emitted, the ANALOG indicator lights up.

HD Radio™ tuner

Operation buttons

- [>>] Displays the other operation button window.
- To hide the window, press [≪≪].
- [AM] Selects the AM band.
- [FM] Selects the FM band.
 → FM1 → FM2 → FM3
- [≪≪] Displays the preset station window. (Page 29)
- To hide the window, press [>>].
- [P1] – [P5]
 - Selects a stored station. (Press)
 - Stores the current station. (Hold)
- [EQ] Displays the **<Equalizer>** screen. (Page 52)
- [CH▼] [CH▲] Selects a sub-channel when receiving an HD Radio multicast channel.
- [◀◀] [▶▶] Searches for a station.
 - The search method differs according to the selected seek mode. (See below.)
- [PTY]* Enters PTY search mode. (Page 29)
- [SEEK] Changes the seek mode.
 - AUTO1**: Auto Search
 - AUTO2**: Tunes in stations in the memory one after another.
 - MANU**: Manual Search
- [AME 📶]* Presets stations automatically. (Hold) (Page 29)
- [TI]* Activates/deactivates TI standby reception mode. (See the far right column.)
- [MODE] Changes the settings for HD Radio reception on the **<Radio Mode>** screen. (See the right column.)

- To display all available operation buttons, press [>>] to display the other operation button window.

* Appears only when FM is selected as the source.

❑ Changing the HD Radio reception mode

While receiving an HD Radio broadcast, the unit tunes to digital or analog audio automatically according to the receiving conditions.

1

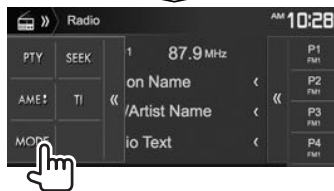
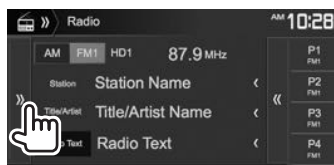

2 Select the HD Radio reception mode.



- <Auto>** Switch between digital and analog audio automatically.
- <Digital>** Select this to tune to digital audio only.
- <Analog>** Select this to tune to analog audio only.

❑ Activating/deactivating TI Standby Reception

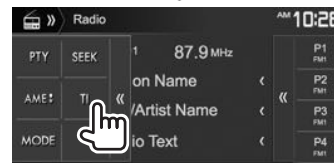
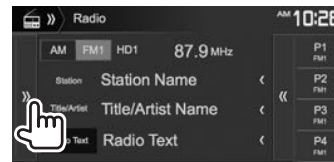

The unit is in standby to switch to Traffic Information (TI) if available. (The TI indicator lights up in white.)

- If the TI indicator is lit in orange, tune into another station.

To deactivate TI Standby Reception: Press [TI]. (The TI indicator turns off.)

- The volume adjustment for Traffic Information is automatically memorized. The next time the unit switches to Traffic Information, the volume is set to the previous level.

HD Radio™ tuner

❑ Searching for FM HD Radio programs—PTY Search

You can search for your favorite programs being broadcast by selecting the PTY code.

1

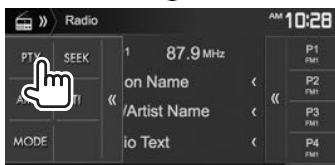
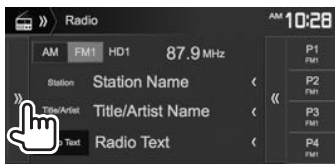

2 Select a PTY code.



- You can change the page to display more items by pressing [**▲**]/[**▼**].

PTY Search starts.

If there is a station broadcasting a program of the same PTY code as you have selected, that station is tuned in.

Presetting stations

❑ Storing stations in the memory

You can preset 5 stations for each band.

Automatic presetting—AME (Auto Memory)

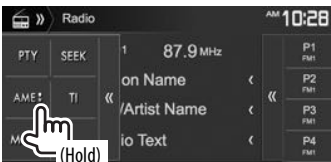
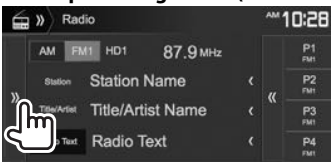

Local stations with the strongest signals are found and stored automatically.

Manual presetting

- Tune in to a station you want to preset. (Page 28)
- Select a preset number.

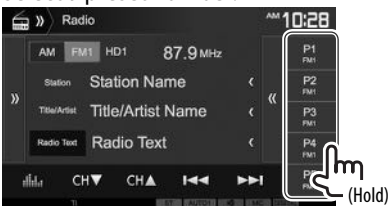

The station selected in step 1 is stored.

❑ Selecting a preset station from the list

- Select the band (①), then display the preset station window (②).

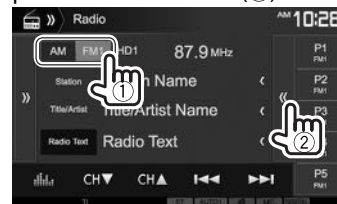

- You can also select a preset station by pressing [**P1**] – [**P5**].

- Select a preset station.

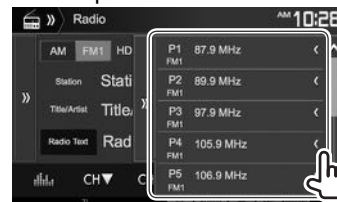

- Pressing [**<**] scrolls the text if not all of the text is shown.
 - To hide the window, press [**>>>**].

RADIO (Only for DDX416BT/DDX393/DDX373BT/DDX23BT)

Listening to the radio

Indications and buttons on the source control screen

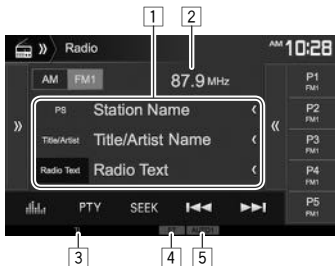

Radio reception information

1 Text information

- Pressing [**<**] scrolls the text if not all of the text is shown.
- Pressing [**Radio Text**] switches the information between Radio Text, Radio Text Plus, and PTY code.

2 The station frequency currently tuned in

3 TI indicator

4 ST/MONO indicator

- The ST indicator lights up when receiving an FM stereo broadcast with sufficient signal strength.

5 Seek mode

Operation buttons

[**>>>**] Displays the other operation button window.

- To hide the window, press [**<<<**].

[**AM**] Selects the AM band.

[**FM**] Selects the FM band.



[**<<<**] Displays the preset station window. (Page 31)

- To hide the window, press [**>>>**].
- Selects a stored station. (Press)
- Stores the current station. (Hold)

[**P1**] – [**P5**]

[**Equalizer**] Displays the **<Equalizer>** screen. (Page 52)

[**PTY**]* Enters PTY search mode. (Page 31)

[**SEEK**] Changes the seek mode.

- AUTO1**: Auto Search
- AUTO2**: Tunes in stations in the memory one after another.
- MANU**: Manual Search

[**<<<**] [**>>>**] Searches for a station.

- The search method differs according to the selected seek mode. (See above.)

[**AME** ↓]* Presets stations automatically. (Hold) (See the right column.)

[**MONO**]* Activates/deactivates monaural mode for better FM reception. (Stereo effect will be lost.)

- The MONO indicator lights up while monaural mode is activated.

[**TI**]* Activates/deactivates TI standby reception mode. (Page 31)

- To display all available operation buttons, press [**>>>**] to display the other operation button window.

* Appears only when FM is selected as the source.

Presetting stations

Storing stations in the memory

You can preset 5 stations for each band.

Automatic presetting—AME (Auto Memory)

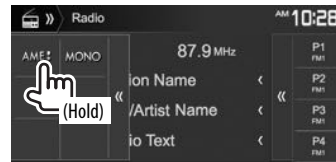
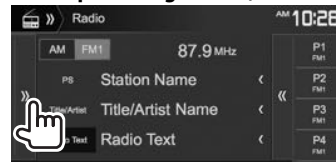

The local stations with the strongest signals are found and stored automatically.

Manual presetting

- Tune in to a station you want to preset. (See the far left column.)
- Select a preset number.

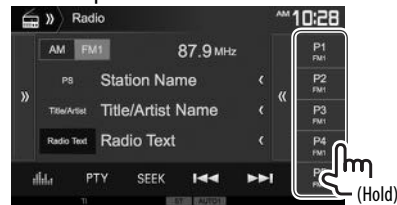

The station selected in step 1 is stored.

RADIO

❑ Selecting a preset station

- 1 Select the band (①), then display the preset station window (②).

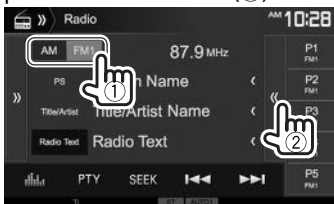

- You can also select a preset station by pressing [P1] – [P5].

- 2 Select a preset station.

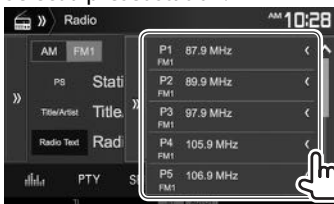

- Pressing [<] scrolls the text if not all of the text is shown.
- To hide the window list, press [>>>].

FM RBDS features

❑ Searching for FM RBDS programs—PTY Search

You can search for your favorite programs being broadcast by selecting the PTY code.

- 1



- 2 Select a PTY code.

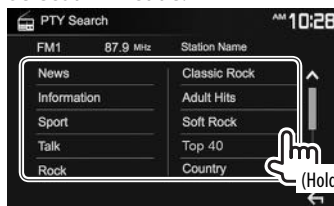

- You can change the page to display more items by pressing [^]/[v].

PTY Search starts.

If there is a station broadcasting a program of the same PTY code as you have selected, that station is tuned in.

❑ Activating/deactivating TI Standby Reception

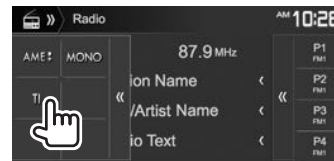
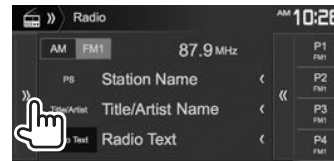

The unit is in standby to switch to Traffic Information (TI) if available. (The TI indicator lights up in white.)

- If the TI indicator is lit in orange, tune into another station providing RBDS signals.

To deactivate TI Standby Reception: Press [TI]. (The TI indicator turns off.)

- The volume adjustment for Traffic Information is automatically memorized. The next time the unit switches to Traffic Information, the volume is set to the previous level.

SiriusXM® Satellite Radio (Only for DDX793/DDX773BH/DDX593/DDX573BH/DDX393/DDX373BT)

Only SiriusXM® brings you more of what you love to listen to, all in one place. Get over 140 channels, including commercial-free music plus the best sports, news, talk, comedy and entertainment. Welcome to the world of satellite radio. A SiriusXM Vehicle Tuner and Subscription are required.

Activating subscription

1 Check your Radio ID.

The SiriusXM Satellite Radio ID is required for activation and can be found by tuning to Channel 0 as well as on the label found on the SiriusXM Connect tuner and its packaging.

- The Radio ID does not include the letters I, O, S or F.

2 When the following screen appears, press [Return].

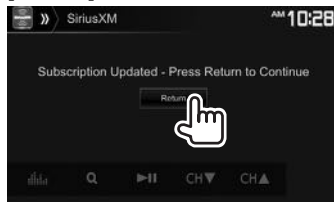

Listening to the SiriusXM® Satellite Radio

Indications and buttons on the source control screen



SiriusXM® Satellite Radio reception information

- 1 Band
- 2 Channel number
- 3 Text information
 - Pressing [←] scrolls the text if not all of the text is shown.
- 4 Information for the buffered data and the replay mode (Page 34)
- 5 Signal strength indicator
- 6 Seek mode

SiriusXM® Satellite Radio

Operation buttons

- [SXM1] – [SXM4]** Selects the band.
→ SXM1 → SXM2 → SXM3 → SXM4
- [>>]** Displays the other operation button window.
• To hide the window, press [≪≪].
- [Song Title]/ [Info]/ [Category]** Changes the displayed information each time this button is pressed.
- [≪≪]** Displays the preset channel window. (See the far right column.)
• To hide the window, press [>>>].
- [EQ]** Displays the **<Equalizer>** screen. (Page 52)
- [Q]** Displays the **<Channel List>** screen. (Page 34)
- [▶||]** Starts/pauses the content replay. (Page 34)
- [CH▼]/[CH▲]** Selects the channel.
- [SEEK]** Changes the seek mode.
• **SEEK1**: Skip to another available channel.
• **SEEK2**: Skip to another preset channel.
- [SCAN]** Starts TuneScan™. (Page 35)
- [◀◀]/[▶▶]** Used while replaying content. (Page 34)
- [Live]**
- [MODE]** Changes the settings for SiriusXM Satellite Radio reception on the **<SiriusXM Mode>** screen. (Pages 35–37)
- To display all available operation buttons, press [>>>] to display the other operation button window.

Presetting channels

❑ Storing channels in the memory

You can preset 5 channels for each band.

- 1 Tune in to a channel you want to preset. (See the left column.)
- 2 Select a preset number.

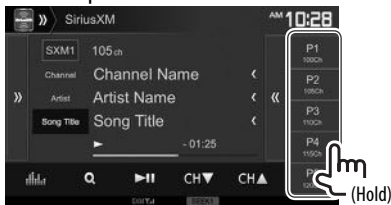

The channel selected in step 1 is stored.

❑ Selecting a preset channel

- 1 Select the band (①), then display the preset channel window (②).

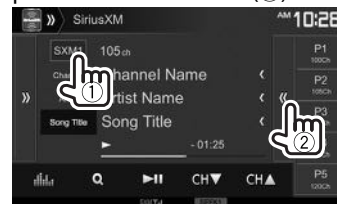

- You can also select a preset channel by pressing [P1] – [P5].

- 2 Select a preset channel.



- Pressing [◀] scrolls the text if not all of the text is shown.
- To hide the window list, press [>>>].

- 3 Select a preset channel in **SEEK2**.

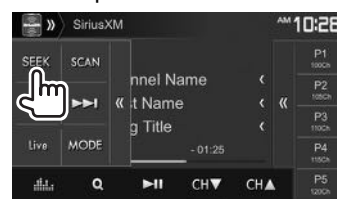

Selecting a channel

❑ Selecting a channel on the list

You can obtain information on channels or select a category and then a channel.

1 Display the <Channel List> screen.



2 Select a category (1), and then select a channel (2).



- You can change the page to display more items by pressing [▲]/[▼].
- To list all the channels, select [All Channels].



- Pressing the info change button above the list displays information in the following order: Channel, Artist, Song Title, Content Info.



Replay

You can pause, rewind and replay content from the currently tuned channel.

- The SiriusXM Connect Vehicle Tuner continually buffers up to 60 minutes of audio.
- If you change to another channel during playback, the Replay buffer content will be lost.

❑ Indications on the source control screen

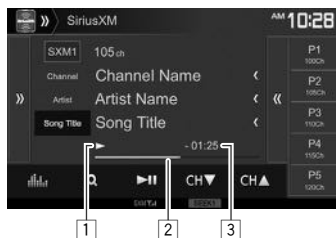

- 1 Playback status
- 2 Replay time bar
Shows the remaining capacity (gray) and the amount of buffered content (blue). If the Replay buffer is full, the entire bar becomes blue.
 - Updated every second.
- 3 Time code
Shows you the point in the Replay buffer you are listening to.
 - Example: -5:00
 - You are listening to audio that is 5 minutes behind the current broadcast.
 - Updated every second.

❑ Replaying content

1 Display operations buttons for replay.

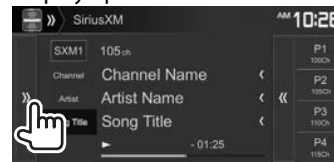

2 Perform the replay operations.

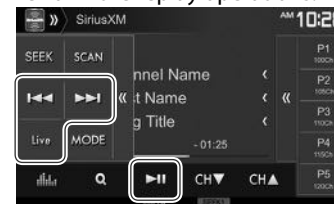

- To start/pause the playback, press [▶/⏸].
- To skip the current track/segment, press [◀◀]/[▶▶].
 - Pressing [◀◀] within 2 seconds of the beginning of the current track/segment returns to the previous track.
 - Pressing [◀◀] after 2 seconds or more of the track have been replayed returns to the beginning of the current track/segment.
- To rewind/fast forward, press and hold [◀◀]/[▶▶].
- To return to the live position, press [Live].

SiriusXM® Satellite Radio

SmartFavorites

User stored channels (P1 to P5) of current band are recognized as SmartFavorites channels. SiriusXM Connect Vehicle Tuner automatically buffers their broadcast content in the background. When you select a SmartFavorite channel, you can rewind and replay up to 30 minutes of any of the missed news, talk, sports or music content.

- SmartFavorites is available only when you connect an SXV200 or later SiriusXM Connect Vehicle Tuner.
- If you change to another band, the buffered content is cleared and new channels in the current band will start buffering.

TuneStart™

When you select a SmartFavorites channel, you can listen to the current song from the beginning.

Activating TuneStart™

- 1 Display the <SiriusXM Mode> screen.

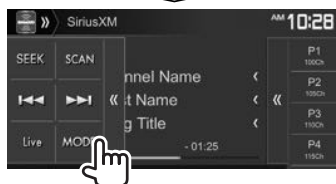
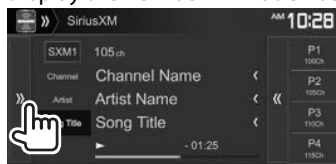

- 2



To deactivate TuneStart: Select [OFF] for <TuneStart>.

TuneScan™

When you activate TuneScan™, you will hear 6 seconds of the songs, which have not been listened to, from each of the music channel presets on the current Band and the currently tuned channel.

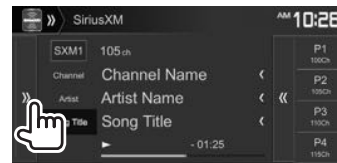

The unit starts scanning.

- To select the previous/next content, press [◀◀] or [▶▶].
- To end scanning and continue listening to the current song/content, press [SCAN].
- To exit scanning, press and hold [SCAN].

SiriusXM® Satellite Radio

Setting reception restrictions

□ Setting the parental control

You can limit access to SiriusXM channels, such as those with mature content.

Setting/Changing the parental code

- The initial setting is "0000."
- Changing the code does not change the <Parental Control>/<Parental Lock Channel Selection> settings.

1 Display the <SiriusXM Mode> screen.

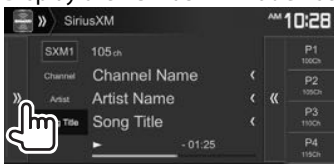

2 Display the <Parental Code Check> screen.



3 Enter a four-digit code (1), and then confirm (2).

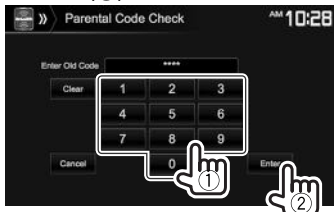

- To clear the entry, press [Clear].
- To cancel setting the code, press [Cancel].

4 Enter a new four-digit code (1), and then confirm (2).

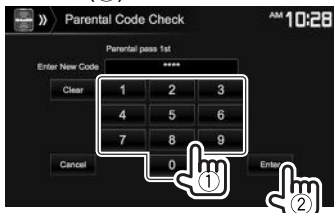

- To clear the entry, press [Clear].
- To cancel setting the code, press [Cancel].

5 Enter the four-digit code and then press [Enter] again to confirm the code.

Activating/Deactivating the parental control

You can set the parental control feature to lock any SiriusXM channel(s) or automatically lock all channels classified as "mature" by SiriusXM®.

1 Display the <SiriusXM Mode> screen. (See the far left column.)

2 Select a parental control mode.



[OFF] Deactivates the parental mature and user lock.

[Mature] Locks channels classified as "mature" only.

[User] Locks only the selected channels.

3 Enter the parental code to confirm your choice.

SiriusXM® Satellite Radio

Selecting the channels to lock—Parental Lock Channel Selection

This parental control option allows you to pick the channels to be locked by the parental control feature.

- When **<Parental Control>** is set to **[Mature]** or **[OFF]**, you cannot change the **<Parental Lock Channel Selection>** setting.

1 Display the **<SiriusXM Mode>** screen. (Page 36)



3 Enter the parental code. The **<Parental Lock Channel Selection>** screen is displayed.

4 Select a category (①), and then a channel (②).



- You can change the page to display more items by pressing [**▲**]/[**▼**].
- To list all the channels, select **[All Channels]**.
- A check mark appears beside the selected channel.

Repeat this step if you want to set the lock on multiple channels.

To deactivate the parental lock for all locked channels: Select **[All Clear]** for **<Parental Lock Channel Selection>** on the **<SiriusXM Mode>** screen, then enter the parental code number.

❑ Skipping unwanted channels

If you do not want to receive some channels, you can skip them.

Activating the channel skipping

1 Display the **<SiriusXM Mode>** screen. (Page 36)

2 Display the **<Skip Channel Selection>** screen.



3 Select a category (①), and then select a channel (②).

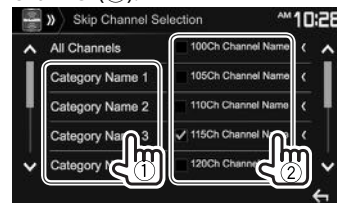

- You can change the page to display more items by pressing [**▲**]/[**▼**].
- To list all the channels, select **[All Channels]**.
- A check mark appears beside the selected channel.

Repeat this step if you want to skip multiple channels.

To clear the channel skipping for all skipped channels: Press and hold **[All Clear]** in **<Skip Channel Selection>** on the **<SiriusXM Mode>** screen.

❑ Resetting the SiriusXM Satellite Radio settings

You can reset the SiriusXM Satellite Radio settings you set up and restore the default settings.

1 Display the **<SiriusXM Mode>** screen. (Page 36)

- Press [**▼**] repeatedly to change the page on the **<SiriusXM Mode>** screen.

2

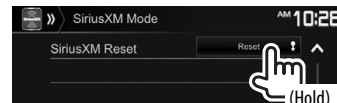

OTHER EXTERNAL COMPONENTS

Using camera

- To connect a camera, see page 70.
- To use a rear view camera, a REVERSE lead connection is required. (Page 68)

Settings for the camera

Rear view camera setting

- 1 Display the <Input> settings screen.
On the Home screen:

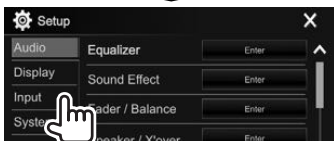
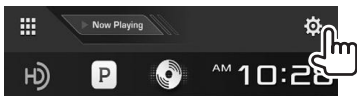

- 2 Display the <Rear Camera> screen.

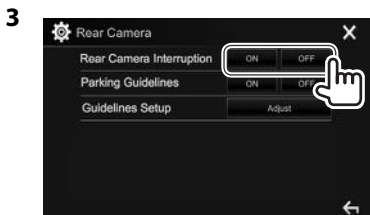
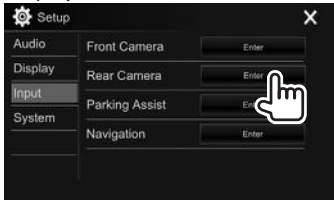

[ON] Displays the picture from the rear view camera when you shift the gear to the reverse (R) position.

[OFF] Select this when no camera is connected

Front view camera settings (Only for DDX793/DDX773BH/DDX593/DDX573BH/DDX393)

- 1 Display the <Input> screen. (See the left column.)
- 2 Display the <Front Camera> screen.

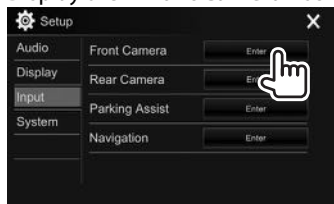

<Front Camera>

- **ON:** Activates the front view camera. Select this to use the front view camera.
- **OFF:** Select this when no camera is connected.

<Reverse Image>

- **ON:** Displays the picture from the front view camera horizontally reversed.
- **OFF:** Displays the picture from the front view camera as it is.

Displaying the camera screen

To display the picture from the rear view camera
The rear view screen is displayed when you shift the gear to the reverse (R) position.



- To remove the caution message, touch the screen.

OTHER EXTERNAL COMPONENTS

To display the picture from the connected camera manually

- Only for DDX793/DDX773BH/DDX593/DDX573BH/DDX393: When <Front Camera> is set to [ON], the picture from the front view camera is displayed. When <Front Camera> is set to [OFF], the picture from the rear view camera is displayed. (Page 38)

On the pop-up short-cut menu (Page 12):

Display the pop-up short-cut menu by pressing MENU on the monitor panel, then select [Camera].



On the monitor panel:

DDX793/DDX773BH

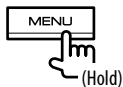

**DDX593/DDX573BH/
DDX393/DDX373BT/
DDX23BT**



DDX416BT

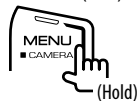

To switch the screen between the front view camera and the rear view camera (only for DDX793/DDX773BH/DDX593/DDX573BH/DDX393)



- Each time you touch the area shown above, the screen is switched between the rear view screen and the front view screen.

To exit the camera screen

On the camera screen:

Touch the area shown below.



On the monitor panel:

DDX793/DDX773BH

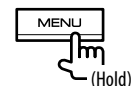

**DDX593/DDX573BH/
DDX393/DDX373BT/
DDX23BT**



DDX416BT

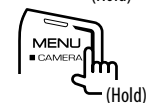

To adjust the picture

While the camera screen is displayed...

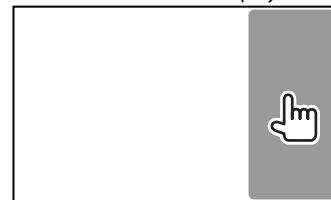

- The picture adjustment menu is displayed. (Page 55)
To close the picture adjustment menu, touch the same area again.

OTHER EXTERNAL COMPONENTS

❑ Using the parking guidelines on the rear view screen

You can display parking guidelines to enable easier parking when you shift the gear to the reverse (R) position.

Displaying the parking guidelines

1 Display the <Input> settings screen.

On the Home screen:

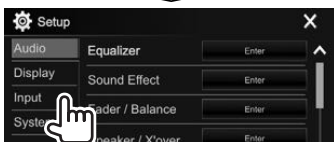
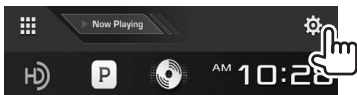

2 Display the <Rear Camera> screen.

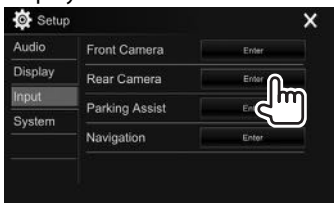

3

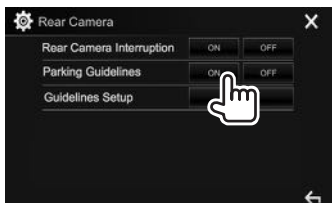

To deactivate: Select [OFF] for <Parking Guidelines>.

- You can also display the parking guidelines by touching the area shown below. To close the parking guidelines, touch the same area again.

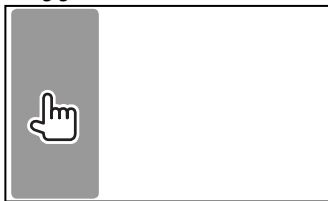



Adjusting the parking guidelines

Adjust the parking guidelines according to the size of the car, parking space and so on.

- Install the rear view camera in the appropriate position according to the instructions supplied with the rear view camera.
- When adjusting the parking guidelines, make sure to use the parking brake to prevent the car from moving.

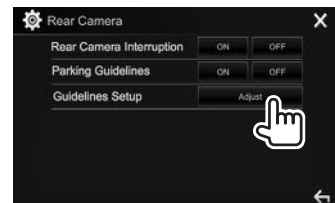

- 1 Display the <Rear Camera> screen. (See the far left column.)
- 2 Display the parking guidelines adjustment screen.

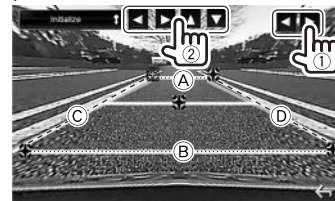

- 3 Adjust the parking guidelines by selecting the  mark (1), then adjusting the position of the selected  mark (2).



Make sure that (A) and (B) are horizontally parallel, and that (C) and (D) are the same length.

- Press and hold [Initialize ] for 2 seconds to set all the  marks to the initial default position.

OTHER EXTERNAL COMPONENTS

Using external audio/video players—AV-IN

When the operation buttons are not displayed on the screen, touch the area shown on the illustration.

- To change settings for video playback, see page 55.

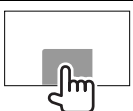

Starting playback

Preparation:

“AV-IN” cannot be selected when <iPod Setup> is set to [USB+AV-IN]. Be sure to select [USB 1 Wire] for <iPod Setup> beforehand. (Page 22)

- 1 Connect an external component to the iPod/AV-IN input terminal. (Page 70)
- 2 Select “AV-IN” as the source. (Page 11)
- 3 Turn on the connected component and start playing the source.



Changing the AV-IN name

You can change the AV-IN name displayed on the “AV-IN” source control screen.

- 1 Display the <VIDEO Mode> screen.



- 2 Select an AV-IN name.



- This setting does not affect the source name displayed on the Home screen.

Using an external component via ADS adapter—OEM Features (Only for DDX793/DDX773BH/DDX593/DDX573BH/DDX393)

You can control the sources from the component via ADS adapter.

Preparation:

Configure the settings on the <Parking Assist> (Page 61)/<OEM Setup> (Page 62) screens beforehand.

- 1 Connect the ADS adapter to the iDataLink input terminal. (Page 70)
- 2 Select “OEM Features” as the source. (Page 11)
- 3 Turn on the connected component and start playing the source.

OTHER EXTERNAL COMPONENTS

Using the external navigation unit (Only for DDX416BT)

You can connect a navigation unit (KNA-G630: optional accessory) to the NAV input terminal so that you can view the navigation screen. (Page 70)

- The navigation guidance comes out of the front speakers even when you are listening to an audio source.

❑ Viewing the navigation screen

On the Home screen:



- While the navigation screen is displayed, the touch panel operations are available only for navigation.
- The aspect ratio of the navigation screen is fixed to **<FULL>** regardless of the **<Aspect>** setting (Page 55).

When receiving a call during navigation guidance

The screen is switched automatically. To return to the navigation screen, press [A].



To exit the navigation screen

On the pop-up short-cut menu (Page 12):
Display the pop-up short-cut menu by pressing MENU on the monitor panel, then select [**Current Source**].

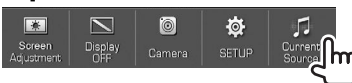

❑ Settings for the navigation unit

1 Display the **<Input>** setting screen.

On the Home screen:

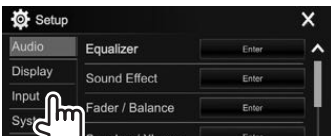
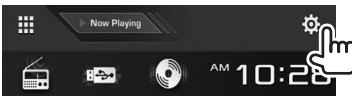

2 Display the **<Navigation>** screen.

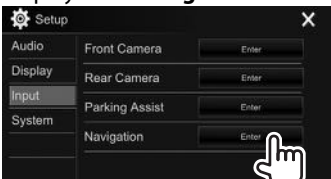

3



<Guidance>

Select which front speakers are used for the navigation guidance.

<Volume>

Adjust the volume of the navigation guidance. (0 to 35)

<NAV Mute>

Select [**ON**] to attenuate the sound coming out of speakers other than the front speakers during navigation guidance.

- To cancel the attenuation, select [**OFF**].

<NAV Setup>

Press [**Enter**] to display the setup screen for the navigation unit. See the instruction manual supplied for the navigation unit.

BLUETOOTH

Information for using Bluetooth® devices



Bluetooth is a short-range wireless radio communication technology for mobile devices such as mobile phones, portable PCs, and other devices. Bluetooth devices can be connected without cables and communicate with each other.

Notes

- While driving, do not perform complicated operations such as dialing numbers, using the phone book, etc. When you perform these operations, stop your car in a safe place.
- Some Bluetooth devices may not connect to this unit depending on the Bluetooth version of the device.
- This unit may not work for some Bluetooth devices.
- Connecting conditions may vary depending on your environment.
- For some Bluetooth devices, the device is disconnected when the unit is turned off.

About mobile phones compatible with Phone book Access Profile (PBAP)

If your mobile phone supports PBAP, you can display the following items on the touch panel screen when the mobile phone is connected.

- Phone book
- Dialed calls, received calls, and missed calls (up to 10 entries in total)

Connecting Bluetooth devices

❑ Registering a new Bluetooth device

When you connect a Bluetooth device to the unit for the first time, pair the unit and the device. Pairing allows Bluetooth devices to communicate with each other.

- The pairing method differs depending on the Bluetooth version of the device.
 - For devices with Bluetooth 2.1: You can pair the device and the unit using SSP (Secure Simple Pairing) which only requires confirmation.
 - For devices with Bluetooth 2.0: You need to enter a PIN code both on the device and unit for pairing.
- Once the connection is established, it is registered in the unit even if you reset the unit. Up to 10 devices can be registered in total.
- Two devices for Bluetooth phone and one for Bluetooth audio can be connected at a time.
- To use the Bluetooth function, you need to turn on the Bluetooth function of the device.
- To use the registered device, you need to connect the device to the unit. (Page 45)

Auto pairing

When <Auto Pairing> is set to [ON], iOS devices (such as iPhone) are automatically paired when connected via USB. (Page 50)

Pairing a Bluetooth device using SSP (for Bluetooth 2.1)

When the Bluetooth device is compatible with Bluetooth 2.1, a pairing request is sent from an available device.

- 1 Search for the unit (“DDX****”) from your Bluetooth device.
- 2 Confirm the request both on the device and the unit.



- Press [Cancel] to reject the request.

BLUETOOTH

Pairing a Bluetooth device using a PIN code (for Bluetooth 2.0)

- 1 Display the **<Bluetooth Setup>** screen.
On the Home screen:

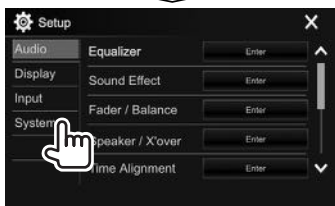
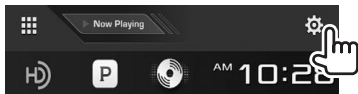

- You can also display the **<Bluetooth Setup>** screen by pressing [**Bluetooth**] on the phone control screen. (Page 47)



- 2 Change the PIN code.
 - If you wish to skip changing the PIN code, go to step 3.
 - The PIN code is initially set to “0000”.
 - The maximum number of digits in the PIN code is 15.

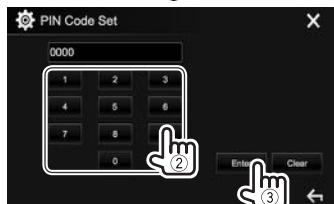

- Press [**Clear**] to delete the last entry.
- 3 Search for the unit (“**DDX******”) from your Bluetooth device.

- 4 Select the unit (“**DDX******”) on your Bluetooth device.
 - If a PIN code is required, enter “0000” (initial).

When pairing is complete, the device is listed on the **<Paired Device List>**.



- To use the paired device, connect the device on the **<Paired Device List>**. (Page 45)

BLUETOOTH

❑ Connecting/disconnecting a registered Bluetooth device

Two devices can be connected simultaneously.

1 Display the <Bluetooth Setup> screen.
(Page 44)

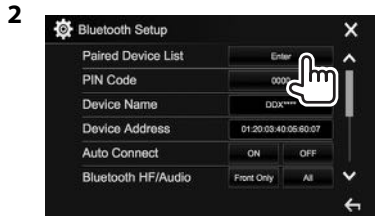

3 Select the device you want to connect (①), then press [Connection] (②).

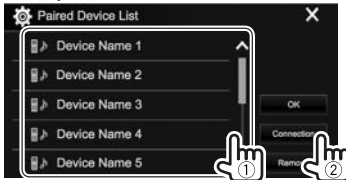

4 Select [ON] (to connect) or [OFF] (to disconnect) for the target (①), then display the <Paired Device List> screen (②).

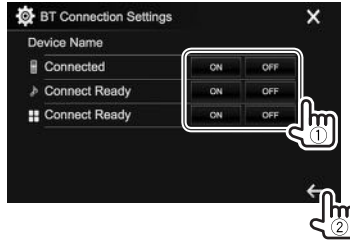

📱: Mobile phone

🎵: Audio device

🎮: Device for using Apps

- The status is shown as follows:
 - “Connecting”: Connection is in progress.
 - “Connected”: A connection has been established.
 - “Connect Ready”: A connection can be established.
 - “Disconnecting”: Disconnection is in progress.
 - “Disconnected”: No connection is established.

5 Connect the selected device.



- When a Bluetooth mobile phone is connected, the signal strength and battery level are displayed when the information is acquired from the device.

❑ Deleting a registered Bluetooth device

1 Display the <Bluetooth Setup> screen.
(Page 44)

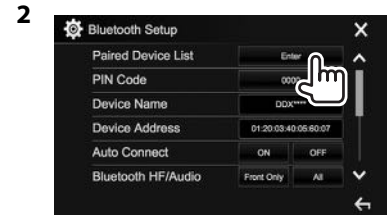

3 Select a device to delete (①), then press [Remove] (②).

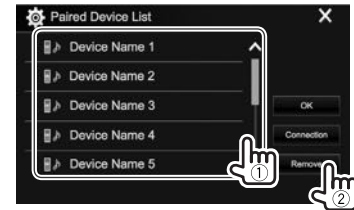

A confirmation message appears. Press [Yes].

BLUETOOTH

Using a Bluetooth mobile phone

Receiving a call

When a call comes in...



- Call information is displayed if acquired.
- Phone operation is not available while the picture from the connected camera is displayed. (Page 38)

To reject a call

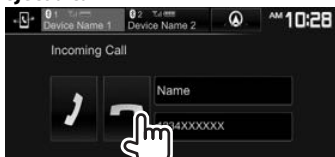

When <Auto Response> is set to [ON] (Page 50)
The unit answers incoming calls automatically.

When receiving a call during navigation guidance (only for DDX416BT)

The screen is switched automatically. To return to the navigation screen, press [A].



Ending a call

While talking...



Adjusting the volume of calls/earpiece/microphone

While talking...



- You can adjust the volume level between -10 to 10 (initial: -4).
- Use the monitor panel to adjust the call/earpiece volume. (Page 8)

Switching between handsfree mode and phone mode

While talking...



Each time you press the button, the talking method is switched (📞↔️📶: handsfree mode / 📞↔️📱: phone mode).

Adjusting the noise reduction/echo cancel level

While talking...



- To adjust the noise reduction volume (between -5 to 5, initial: 0) : Adjust <NR LEVEL>.
- To adjust the echo volume (between -5 to 5, initial: 0): Adjust <EC LEVEL>.

BLUETOOTH

❑ Sending text during a call

You can send text during a call using the DTMF (Dual Tone Multi Frequency) function.

While talking...



❑ Switching between two connected devices

When 2 devices are connected, you can change the device to use.

While using a Bluetooth mobile phone, select the device you want to use.



- The active device is highlighted.

❑ Making a call

- 1 Display the phone control screen.

On the Home screen:

- Press [] to change the page.

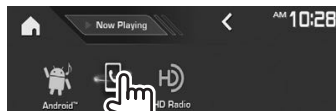
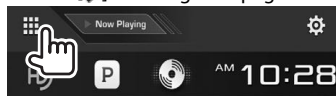

- You can also display the phone control screen by pressing TEL on the monitor panel.

- 2 Select a method to make a call.



- 1 From the call history*
- 2 From the phone book*
- 3 From the preset list
- 4 Direct number entry
- 5 Voice dialing

- You can display the <Bluetooth Setup> screen by pressing [].

- * When the mobile phone is not compatible with Phone Book Access Profile (PBAP), the call history and the phone book are not displayed.

From the call history/phone book/preset list

- 1



- [] From the call history (missed calls/received calls/dialed calls)

- [] From the phone book

- [★] From the preset list

- 2 Select the target (①), then make a call (②).



- You can change the page to display more items by pressing []/[].

BLUETOOTH

- To use the A to Z search in the phone book:

1



2 Select the initial.

- If the initial character is a number, press [1,2,3...] and then select the number.



3 Select a phone number from the list.



- To display other phone numbers:

When the phone book list is displayed, you can switch between phone numbers if several phone numbers are registered for the same contact (up to 10 phone numbers per contact).

1 Switch the phone number.

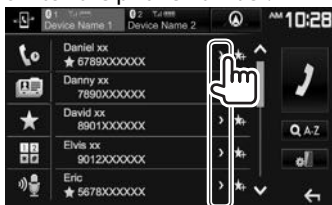

- The phone number switches each time [>] is pressed.

2 Select a phone number to call.



Direct number entry

You can enter up to 31 numbers.



- Press [X] to delete the last entry.
- Press and hold [0/+] to add "+" to the phone number.

Voice dialing

- Available only when the connected mobile phone has a voice recognition system.

1 Activate voice dialing.

On the phone control screen:



- When iPhone is connected, Siri is activated.
- You can also activate voice dialing by holding TEL on the monitor panel.

2 Say the name of the person you want to call.

- If the unit cannot find the target, the following screen appears. Press [Start], then say the name again.



To cancel voice dialing: Press [Cancel].

BLUETOOTH

❑ Presetting phone numbers

You can preset up to 5 phone numbers.

- 1 Display the phone control screen.
(Page 47)
- 2 Select phone book or call history.



- 3 Select a phone number to preset.

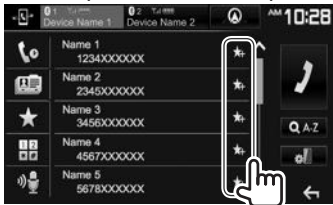

The preset list is displayed.

- 4 Select a preset number to store into.



- To display the preset list, press [★] on the phone control screen. (Page 47)

Using the Bluetooth audio player

- To register a new device, see page 43.
- To connect/disconnect a device, see page 45.

❑ Indications and buttons on the source control screen



- The operation buttons, indications and information displayed on the screen differ depending on the connected device.

Playback information

- 1 Tag data (current track title/artist name/album title)*¹
 - Pressing [←] scrolls the text if not all of the text is shown.
- 2 The signal strength and battery level (Appear only when the information is acquired from the device.)
- 3 Playing time*¹
- 4 Playback status*¹

Operation buttons

- [>>]) Displays the other operation button window.
 - To hide the window, press [≪≪].
- [📶]] Displays the <Equalizer> screen. (Page 52)
- [Q] Displays the track list. (Page 50)
- [|<<<] [>>>|]
 - Selects a track. (Press)
 - Reverse/forward search.*¹ (Hold)
- [▶] Starts playback.
- [⏸] Pauses playback.
- [🔀] Selects random playback mode.*²
- [🔁] Selects repeat playback mode.*²
- [⚙️] Displays the <Bluetooth Setup> screen. (Page 50)

- To display all available operation buttons, press [>>]) to display the other operation button window.

*¹ Available only for devices compatible with AVRCP 1.3.

*² The random and repeat functions vary depending on the Bluetooth audio device.

BLUETOOTH

❑ Selecting an audio file from the menu

1



2 Select a category (①), then a desired item (②).



- Select an item in each layer until you reach and select the desired file.
- You can change the page to display more items by pressing [**▲**]/[**▼**].
- Press [**⏪**] to return to the upper layer.
- If you want to play all tracks in the folder, press [**▶**] on the right of the desired folder.

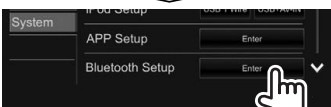
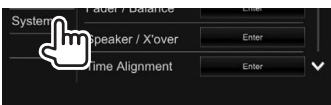

- You can also display the **<Bluetooth Setup>** screen by pressing [**⚙**] on the phone control screen (Page 47) or [**⚙**] on the “**BT Audio**” source control screen (Page 49).

2 Configure the Bluetooth settings.



❑ Setting items

<Paired Device List>	Press [Enter] to show the list of registered devices. You can connect a device or delete registered devices. (Page 45)
<PIN Code>	Changes the PIN code of the unit. (Page 44)
<Device Name>	Shows the device name to be shown on the Bluetooth device — DDX**** .

<Device Address>	Shows the device address of the unit.
<Auto Connect>	<ul style="list-style-type: none"> • ON (Initial): A connection is automatically established with the last connected Bluetooth device when the unit is turned on. • OFF: Cancels.
<Bluetooth HF/Audio>	Select the speakers used for Bluetooth (both phone and audio player). <ul style="list-style-type: none"> • Front Only: Front speakers only. • All (Initial): All speakers.
<Auto Response>	<ul style="list-style-type: none"> • ON: The unit answers the incoming calls automatically after 5 seconds. • OFF (Initial): The unit does not answer the calls automatically. Answer the calls manually.
<Auto Pairing>	<ul style="list-style-type: none"> • ON (Initial): Establishes pairing automatically with the connected iOS device (such as iPhone) even if the Bluetooth function is deactivated on the device. (Auto pairing may not work for some devices depending on the iOS version.) • OFF: Cancels.
<Initialize>	Hold [Enter] to reset all settings you have made for using Bluetooth mobile phones and Bluetooth audio players.

Settings for Bluetooth devices

You can change various settings for using Bluetooth devices on the **<Bluetooth Setup>** screen.

1 Display the **<Bluetooth Setup>** screen. On the Home screen:



SETTINGS

Settings for using applications of iPod touch/iPhone/Android/BlackBerry

Before using applications of iPod touch /iPhone/ Android/BlackBerry such as Pandora, select the device to use.

When connecting the device for first time, the setup screen (for connection, etc.) appears. Follow the procedure on the setup screen to configure the settings.

Preparation:

- **For Android/BlackBerry:** Connect the Android/ BlackBerry device via Bluetooth. (Page 43)
- **For iPod touch/iPhone:**
 - Connect iPod touch/iPhone with a cable. (Page 69)
 - Select the connection method of iPod touch/iPhone on <iPod Setup>. (Page 22)

- 1 Display the <APP Setup> screen.
On the Home screen:

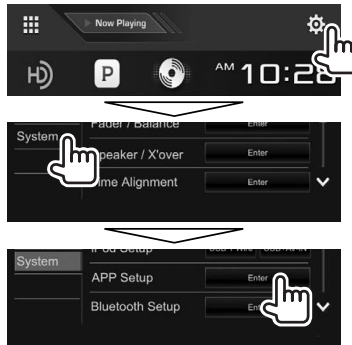

- If [Enter] for <APP Setup> cannot be selected, put the unit in standby. (Page 9)
- 2 Select the device type (①), then press [OK] (②).

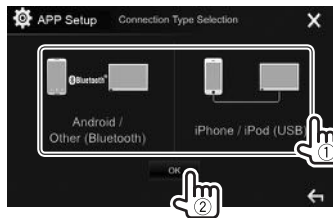

- When selecting [iPhone/iPod (USB)], the setting is complete.

- 3 When selecting [Android/Other (Bluetooth)] as the device type: Select the Android/BlackBerry device (①), then press [OK] to connect (②).

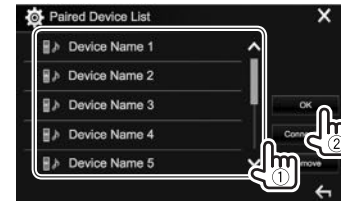

- You can change the page to display more items by pressing [▲]/[▼].

SETTINGS

Sound adjustment

❑ Using the sound equalization

- The adjustments are memorized for each source until you adjust the sound again. If the source is a disc, the adjustments are stored for each of the following categories.
 - DVD/VCD
 - CD
 - DivX/MPEG1/MPEG2/MP3/WMA/WAV/AAC
- You cannot adjust the sound when the unit is in standby.

Selecting a preset sound mode

- 1 Display the **<Equalizer>** screen.
On the Home screen:

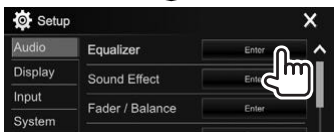
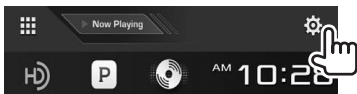

- 2 Select a sound mode.



- You can change the page to display more items by pressing [**▲**]/[**▼**].
- You can also display the **<Equalizer>** screen by pressing [**⏏**] on the source control screen.

Storing your own adjustments—Adjusting the sound precisely

- 1 Select a sound mode. (See the left column.)
- 2 Select a band and adjust the level of the selected band.
 - You can adjust the level by dragging the slider or using [**▲**]/[**▼**].
 - Repeat this step to adjust the level of other bands.

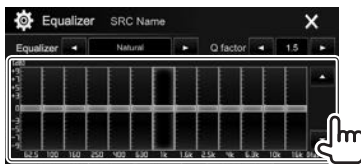

The adjustments are stored and **<User>** is activated.

- 3 Adjust the sound.



<Q factor> Adjusts the width of the frequency.

<Bass EXT> Activates (**[ON]**)/deactivates (**[OFF]**) bass.

<SW LEVEL> Adjusts subwoofer level.*

- To apply the adjusted equalizer to all playback sources, press [**ALL SRC**], then press [**OK**] to confirm.
- To clear the adjustment, press [**EQ INT**].

* Not adjustable when **<None>** is selected for subwoofer on the **<Speaker Select>** screen. (Page 53)

SETTINGS

□ Setting the speakers—car type, speaker size and crossover frequency

1 Display the <Car Setting> screen.

On the Home screen:

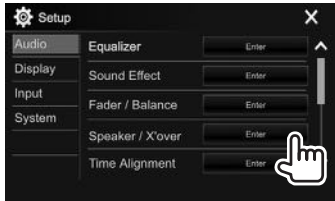
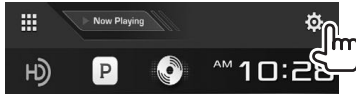

2 Select a car type (①), select the location of the speakers (②), then display the <Speaker Select> screen (③).



3 Select the speaker type (①), select the size of the selected speaker (②), then display the <X'over> screen (③).



- When a speaker is not connected, select **<None>**.
- When setting the front speakers, also select the speaker size for **<Tweeter>**.

4 Adjust the crossover frequency of the selected speaker.

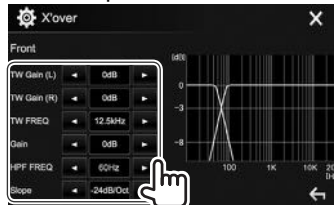

- <TW Gain (L)>/<TW Gain (R)>** Adjusts the output volume of the tweeter (left/right).^{*1*2}
- <TW FREQ>** Adjusts the crossover frequency for the tweeter.^{*1*2}
- <Gain>** Adjusts the output volume of the selected speaker.
- <HPF FREQ>** Adjusts the crossover frequency for the front or rear speakers (high pass filter).^{*3}
- <LPF FREQ>** Adjusts the crossover for the subwoofer (low pass filter).^{*4}
- <Slope>** Adjusts the crossover slope.^{*5}
- <Phase>** Selects the phase for the subwoofer.^{*4}

*1 Appears only when the front speakers are selected.

*2 Adjustable only when **<Tweeter>** is set to **<Small>**, **<Middle>**, or **<Large>** on the **<Speaker Select>** screen.

*3 Appears only when the front or rear speakers are selected.

*4 Appears only when the subwoofer is selected.

*5 Not adjustable when **<HPF FREQ>** or **<LPF FREQ>** is set to **<Through>**.

SETTINGS

❑ Adjusting the Digital Time Alignment (DTA)

Make fine adjustments to the delay time of the speaker output to create a more suitable environment for your vehicle.

- 1 Display the **<Time Alignment>** screen. On the Home screen:

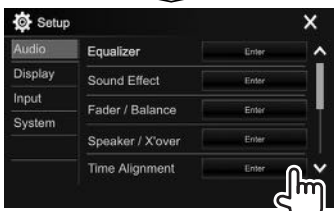
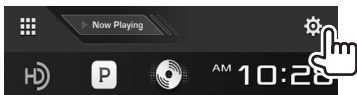

- 2 Select the listening position (**<All>**, **<Front L>**, **<Front R>** or **<Front All>**).

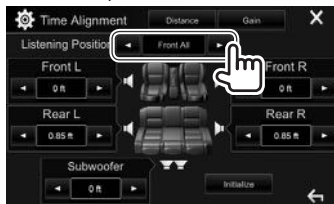

- 3 Select an item to make an adjustment.

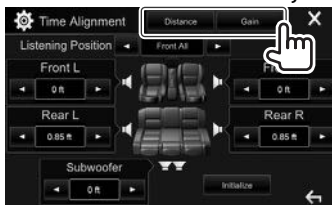

[Distance] Adjusts the Digital Time Alignment (DTA) value.

[Gain] Adjusts the output volume of the selected speaker.

- 4 Adjust each speaker setting.

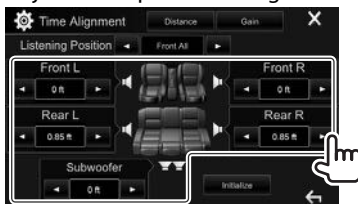

- To determine the adjustment value, see the right column.
- To initialize the setting value, press **[Initialize]**.

Determining the value for <Position DTA> adjustment

If you specify the distance from the center of the currently set listening position to every speaker, the delay time will be automatically computed and set.

- ① Determine the center of the currently set listening position as the reference point.
- ② Measure the distances from the reference point to the speakers.
- ③ Calculate the differences between the distance of the furthest speaker and other speakers.
- ④ Set the DTA value calculated in step ③ for individual speakers.
- ⑤ Adjust gain for individual speakers.

Example: When **<Front All>** is selected as the listening position

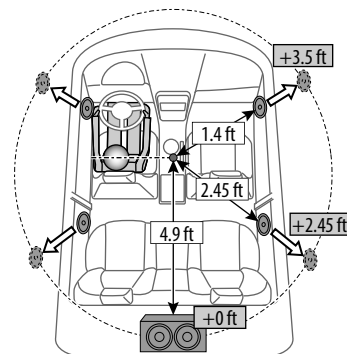

SETTINGS

Adjustment for video playback

Adjusting the picture

You can adjust the picture quality.

1 Display the picture adjustment screen.

On the source control screen:



2 Select [DIM ON] (dimmer on) or [DIM OFF] (dimmer off) (1), then adjust the picture (2).



- <Bright>** Adjusts the brightness. (-15 to +15)
- <Contrast>** Adjusts the contrast. (-10 to +10)
- <Black>** Adjusts the blackness. (-10 to +10)
- <Color>** Adjusts the color. (-10 to +10)
- <Tint>** Adjusts the tint. (-10 to +10)
- <Sharpness>** Adjusts the sharpness. (-2 to +2)

- You can also display the picture adjustment screen by selecting [**Screen Adjustment**] on the pop-up short-cut menu (Page 12).

Changing the aspect ratio

You can change the aspect ratio for video playback.

1 Display the aspect ratio selection screen.

On the source control screen:

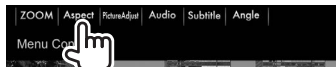

2 Select the aspect ratio.



<FULL>* For 16:9 original pictures

4:3 signal 16:9 signal



<JUST> For viewing 4:3 pictures naturally on the wide screen

4:3 signal 16:9 signal



<Normal>* For 4:3 original pictures

4:3 signal 16:9 signal



<Auto> For "DISC"/"USB" only: The aspect ratio is automatically selected to match the incoming signals.

* While DivX is played back with **<Screen Ratio>** set to **[16:9]** (Page 17 for discs/Page 19 for USB), the aspect ratio may not set correctly.

SETTINGS

Zooming the picture

You can zoom the picture (<FULL>, <Zoom1> to <Zoom3>).

- When <Aspect> is set to <JUST> or <Auto> (Page 55), the picture is zoomed with the aspect ratio of the <FULL> setting.

- 1 Display the magnification level selecting screen.

On the source control screen:



- 2 Change the magnification (①), then move the zooming frame (②).



- The zoom function cannot be used for some video sources.

Changing the display design

You can change the background and panel color.

- 1 Display the <User Customize> screen. On the Home screen:

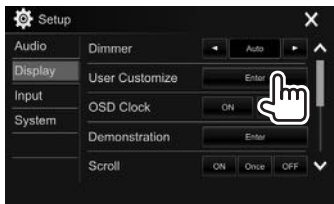
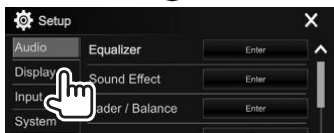
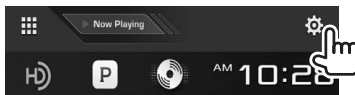

- 2 Select an item to change (background design: [Background]/panel color: [Panel Color]).

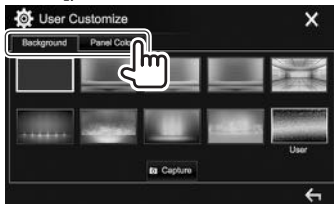

- 3 Select a background/panel color.

To select a background

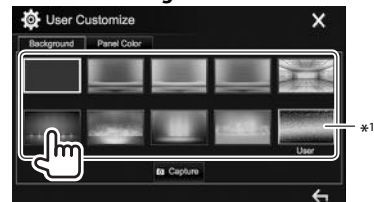

To select a panel color

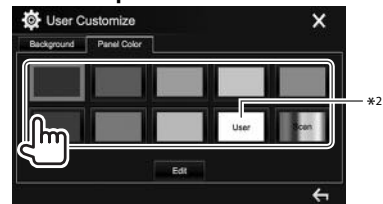

- Selecting [Scan] changes the illumination color gradually.

*1 Store your own scene beforehand. (Page 57)

*2 Store your own color adjustment beforehand. (Page 57)

SETTINGS

❑ Making your own color adjustment

1 Select [Panel Color] on the <User Customize> screen. (Page 56)

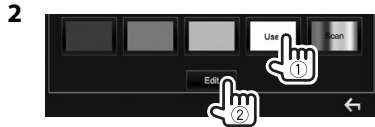

3 Select the dimmer setting for the color (①), then adjust the color (②).



❑ Storing your own scene for the background image

While playing a video or picture, you can capture an image and use the captured image as a background.

- You cannot capture copyrighted content and images from iPod/iPhone.
- When using a JPEG file as the background, make sure that the resolution is 800 x 480 pixels.
- The color of the captured image may look different from that of the actual scene.

1 Play a video or picture.

2 Display the <User Customize> screen. (Page 56)

3 Display the image adjustment screen.

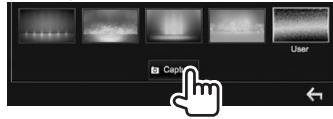

4 Adjust the image.



- [▲][▼][◀][▶] Moves the zooming frame.
- [🔍] Magnifies the scene. (<OFF>, <Zoom1> - <Zoom3>)
- [▶||]* Starts/pauses playback.
- [▶▶]* Advances scenes frame-by-frame.

- To cancel the capture, press [Cancel].

5 Capture the image displayed on the screen.

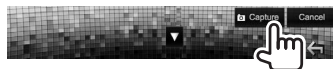

A confirmation message appears. Press [Yes] to store the newly captured image. (The existing image is replaced with the new one.)

- Press [No] to return to the previous screen.

* Not displayed when playing an external component connected to the iPod/AV-IN input terminal.

Customizing the Home screen

You can arrange the items to display on the Home screen.

1 Display the <HOME Customize> screen. On the Home screen:

- Press [▼] repeatedly to change the page on the <Display> menu screen.

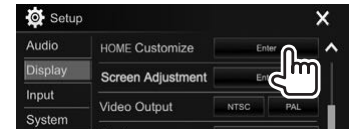
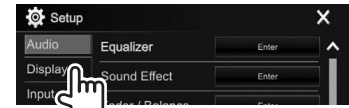

2 Select the position to place the icon (①), then select the item you want to display in the selected position (②).



Repeat this step to place icons for other items.

SETTINGS

Customizing the system settings

❑ Memorizing/recalling the settings

- You can memorize the settings changed in the <Setup> menu and recall the memorized settings any time.
- The memorized settings are kept even when the unit is reset.

1 Display the <SETUP Memory> screen.

On the Home screen:

- Press [▼] repeatedly to change the page on the <System> menu screen.

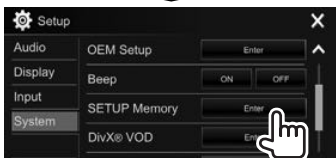
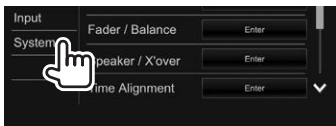
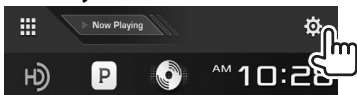

2



- To cancel, press [No].

3 Select an operation.



- [Recall]** Recalls the memorized settings.
- [Memory]** Memorizes the current settings.
- [Clear]** Clears the currently memorized settings.

- To cancel, press [Cancel].

A confirmation message appears. Press [Yes].

❑ Locking the settings

You can lock the settings to prevent them from being changed.

-  is shown beside the settings that can be locked.

1 Display the <SETUP Memory> screen. (See the left column.)

2

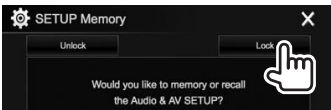

To unlock the setting: Press [Unlock].

❑ Updating the system

You can update the system by connecting a USB device containing an update file.

1 Create an update file and copy it to a USB device.

- To connect a USB device, see page 69.

2 Display the <System Information> screen.

On the Home screen:

- Press [▼] repeatedly to change the page on the <System> menu screen.

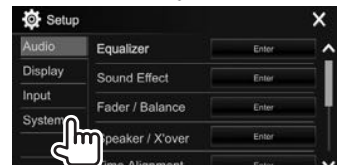
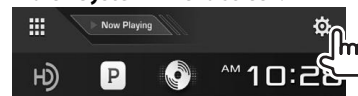

SETTINGS

3



- <Application Version>** Updates the system application.
- <System Version>** Updates the system.
- <DVD Version>** Updates the DVD system application.
- <HD Radio Version>*** Updates the HD Radio module application.

It may take a while.

If the update has been completed successfully, "Update Completed" appears. Reset the unit.

- Do not disconnect the USB device while updating.
- If the update has failed, turn the power off and then on, and retry the update.
- Even if you have turned off the power during the update, you can restart the update after the power is turned on. The update will be performed from the beginning.

* Only for DDX793/DDX773BH/DDX593/DDX573BH.

Adjusting the touch position

You can adjust the touch position on the touch panel if the position touched and the operation performed do not match.

1 Display the <Touch Panel Adjust> screen.

On the Home screen:

- Press [**▼**] repeatedly to change the page on the <System> menu screen.

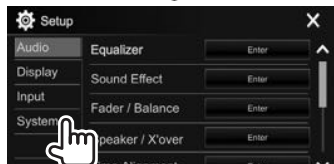

2 Touch the center of the marks at the upper left (①), the lower center (②), then the upper right (③) as instructed.

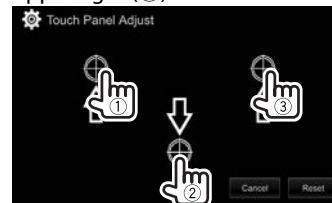

- To reset the touch position, press [**Reset**].
- To cancel the current operation, press [**Cancel**].

SETTINGS

Setting menu items

□ Displaying the <Setup> menu screen

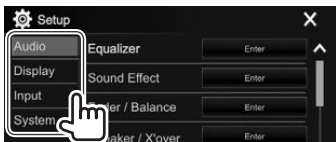
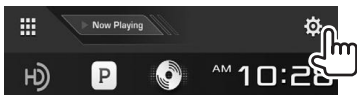

- You can change the page to display more items by pressing [**▲**]/[**▼**].
- You can also display the <Setup> screen by selecting [**SETUP**] on the pop-up short-cut menu (Page 12).
- You cannot change the <Audio> settings screen in the following situations:
 - When the unit is in standby (Page 9)
 - When the Bluetooth phone is used (making or receiving a call, during a call, or while voice dialing)
 - During navigation guidance*

* Only for DDX416BT.

□ <Audio> setting screen

<Equalizer>

Change the sound mode or adjust and store the equalization for each source. (Page 52)

- **Equalizer:** Selects the preset sound mode.
 - **Natural** (Initial)/**Rock/Pops/Easy/Top40/Jazz/Powerful/User**
- **Q factor:** Adjusts the width of the frequency.
 - **1.35/1.5** (Initial)/**2.0**
- **Bass EXT:** Activates/deactivates bass.
 - **ON/OFF** (Initial)
- **SW LEVEL:** Adjusts the subwoofer level.
 - **-50 to +10** (Initial: **0**)

<Sound Effect>

Adjust the sound effect.

- **Loudness:** Adjusts loudness.
 - **OFF** (Initial)/**Low/High**
- **Bass Boost:** Selects the bass boost level.
 - **OFF** (Initial)/**Level 1/Level 2/Level 3/Level 4/Level 5**
- **Drive EQ:** You can reduce the driving noise by raising the bandwidth.
 - **OFF** (Initial)/**ON**
- **Space Enhancer***¹: Virtually enhances the sound space using the Digital Signal Processor (DSP) system. Select the enhance level.
 - **OFF** (Initial)/**Small/Medium/Large**
- **Supreme***²: Restores the sound lost due to audio compression to a realistic sound.
 - **OFF/ON** (Initial)

- **Sound Realizer:** Virtually makes the sound more realistic using the Digital Signal Processor (DSP) system. Select the sound level.
 - **OFF** (Initial)/**Level 1/Level 2/Level 3**
- **Stage EQ:** You can move the center of the sound to the lower or higher point. Select the height.
 - **OFF** (Initial)/**Low/Middle/High**

<Fader/Balance>

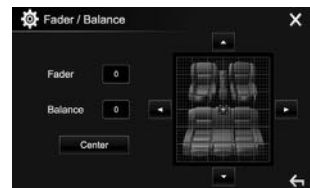

Fader: Adjusts the front and rear speaker output balance.

- **F15 to R15** (Initial: **0**)
 - When using a two-speaker system, set the fader to the center (**0**).

Balance: Adjusts the left and right speaker output balance.

- **L15 to R15** (Initial: **0**)

Press [**▲**]/[**▼**]/[**◀**]/[**▶**] or drag [**✚**] to adjust.

- To clear the adjustment, press [**Center**].

<Speaker/X'over>

Select the car type/speaker size and adjust the crossover frequency. (Page 53)

*¹ You cannot change the setting when "Radio" is selected as the source.

*² This function works only when "DISC"/"USB"/"iPod"/"Android"[™] is selected as the source.

SETTINGS

<Time Alignment>

Select the listening position, then adjust the delay time of the speaker output to create a more suitable environment for your vehicle. (Page 54)

<Volume Offset>

Adjust and store the auto-adjustment volume level for each source. (For discs, the adjustment is stored for each of the following categories: DVD/VCD, CD, and DivX/MPEG1/MPEG2/WMV/MP3/WMA/WAV/AAC.) The volume level will automatically increase or decrease when you change the source.

- **-15 to +6** (Initial: **00**)

<Display> setting screen

<Dimmer>

- **Auto** (Initial): Dims the screen and button illumination when you turn on the headlights.
 - The ILLUMI lead connection is required. (Page 68)
- **ON**: Activates dimmer.
- **OFF**: Cancels.
- **NAV***1: Activates or deactivates dimmer according to the day/night display setting of the connected navigation unit.

<User Customize>

Change the display design. (Page 56)

<OSD Clock>

- **ON**: Displays the clock while a video source is playing.
- **OFF** (Initial): Cancels.

<Demonstration>

- **ON** (Initial): Activates the demonstration on the screen.
- **OFF**: Cancels.

<Scroll>

- **ON** (Initial): Scrolls the displayed information repeatedly.
 - **Once**: Scrolls the displayed information once.
 - **OFF**: Cancels.
- Pressing [**<**] scrolls the text regardless of this setting.

<HOME Customize>

Change the items to display on the Home screen. (Page 57)

<Screen Adjustment>

Adjust the brightness and blackness of the screen. Press [**Enter**] to display the setting screen, select [**DIM ON**] (dimmer on)/[**DIM OFF**] (dimmer off), then change the following settings:

- **Bright**: Adjusts brightness.
 - **-15 to +15** (Initial: **0** for dimmer on/+15 for dimmer off)
- **Black**: Adjusts blackness.
 - **-10 to +10** (Initial: **0**)

<Video Output>*2

Select the color system of the external monitor.

- **NTSC** (Initial)/**PAL**

<Angle>*3

Adjust the panel angle. (Page 8)

*1 Only for DDX416BT.

*2 "Please Power Off" appears when the setting is changed. Turn off the power, then turn on to enable the change.

*3 Only for DDX793/DDX773BH.

<Input> setting screen

<Front Camera>*1

Configure the front view camera settings. (Page 38)

- **Front Camera**: Activates or deactivates the front view camera.

- **Reverse Image**: Selects whether to reverse the picture from the front view camera or not.

<Rear Camera>

Configure the rear view camera settings.

• **Rear Camera Interruption** (Page 38):

- **ON**: Displays the picture from the rear view camera when you shift the gear to the reverse (R) position.
- **OFF** (Initial): Select this when no camera is connected

• **Parking Guidelines**: Displays (**ON**: Initial) or hides (**OFF**) the parking guidelines. (Page 40)

• **Guidelines Setup**: Adjusts the parking guidelines. (Page 40)

<Parking Assist>*1

Configure settings for using the ADS adapter.

• **Parking Assist Display**: When an ADS adapter is connected, you can display information about obstacles around the car.

- **ON**: Always displays information.
- **Dyn.** (Initial): Displays information when the sensor detects obstacles.
- **OFF**: Cancels.

• **Parking Assist Position**: Selects where information about obstacles is displayed on the screen

- **Left/Right** (Initial)

<Navigation>*2

Change the navigation settings. (Page 42)

*1 Only for DDX793/DDX773BH/DDX593/DDX573BH/DDX393.

*2 Only for DDX416BT.

SETTINGS

☐ <System> setting screen

<Language>*1

Select the text language used for on-screen information.

- **English** (Initial)/**Español**/**Français**/**Deutsch**/**Italiano**/**Nederlands**/**Ελληνικά**/**Português**/**Türkçe**/**Čeština**/**Polski**/**Magyar**/**Русский**/**עברית**/**العربية**/**فارسی**/**ไทย**/**ភាសាខ្មែរ**/**简体中文**/**繁體中文**/**Bahasa Indonesia**/**한국어**
 - For external monitors, only English/Spanish/French/German/Italian/Dutch/Russian/Portuguese/Chinese Simplified are available. If another language has been selected, the text language for external monitors will be set to English.
- **GUI Language**: Selects the language used for displaying operation buttons and menu items.
 - **English** (Initial)/**Local** (the language selected above)

<Clock>

Adjust the clock time. (Page 5)

<iPod Setup>

Specify the connection method of iPod/iPhone. (Page 22)

<APP Setup>

Configure the App settings. (Page 51)

<Bluetooth Setup>

Configure settings for using a Bluetooth device, such as connection and other general operations. (Page 50)

<OEM Setup>*2

Shows information about/changes the settings for using the ADS adapter.

<Beep>

- **ON** (Initial): Activates the key-touch tone.
- **OFF**: Cancels.

<SETUP Memory>

You can memorize, recall, or clear the settings you have made. (Page 58)

<DivX(R) VOD>*3

This unit has its own Registration Code. Once you have played back a file with the Registration Code recorded, this unit's Registration Code is overwritten for copyright protection.

- Press [**Enter**] to display the information.
- To return to the previous screen, press [**OK**].

<Security Code>*3

Register the security code for the unit. (Page 4)

<SI>

Activate or deactivate the security function. (Page 5)

<Serial Number>*4

Displays the serial number.

<Touch Panel Adjust>

Adjust the touch positions of the buttons on the screen. (Page 59)

<Steering Remote Controller>*3

Assign functions to the keys on the remote controller of the steering wheel. (Page 65)

<System Information>

Displays the version information of the software. You can update the software. (Page 58)

<Open Source Licenses>

Shows the Open Source Licenses.

*1 "Please Power Off" appears when the setting is changed. Turn off the power, then turn on to enable the change.

*2 Only for DDX793/DDX773BH/DDX593/DDX573BH/DDX393.

*3 Only for DDX416BT.

*4 Only for DDX793/DDX773BH/DDX593/DDX573BH/DDX393/DDX373BT.

REMOTE CONTROLLER

Overview

DDX416BT:

This unit can be operated using the Remote Controller (RC-DV340) supplied with this unit.

DDX793/DDX773BH/DDX593/DDX573BH/DDX393/DDX373BT/DDX23BT:

Optional Remote Controller KNA-RCDV331 is designed for controlling this unit. Refer to the instruction manual that comes with the remote controller.

⚠ Caution:

- Put the Remote Controller in a place where it will not move during braking or other operations. A dangerous situation could result if the Remote Controller falls down and gets wedged under the pedals while driving.
- Do not leave the battery near fire or under direct sunlight. A fire, explosion or excessive heat generation may result.
- Do not recharge, short, break up or heat the battery, or place it in an open fire. Such actions may cause the battery to leak fluid. If spilled fluid comes in contact with your eyes or clothing, immediately rinse with water and consult a physician.
- Place the battery out of reach of children. In the unlikely event that a child swallows the battery, immediately consult a physician.

❑ Battery installation

Use two “AAA”/“R03”-size batteries.

Insert the batteries with the + and – poles aligned properly, following the illustration inside the case.

- Always insert batteries from – poles to prevent spring bend.

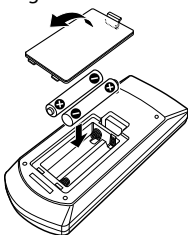

- If the Remote Controller operates only over shorter distances or does not operate at all, it is possible that the batteries are depleted. In such instances, replace both batteries with new ones.

❑ Remote Controller mode switch

The functions operated from the remote controller differ depending on the position of the mode switch.

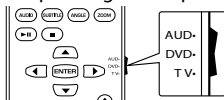

AUD mode: Switch to this mode when controlling a selected source or tuner source, etc.

DVD mode: Switch to this mode when playing DVDs or CDs etc. with the player integrated in this unit.

TV mode: Not used.

- The position of the remote control mode switch is indicated in the title of each mode, e.g., “AUD mode”.
- When controlling a player that is not integrated in the unit, select “AUD” mode.

Operations from the remote controller

❑ Common operations (AUD mode)

SRC	<ul style="list-style-type: none">• Selects the source.• Hangs up the incoming/current call.
▲/▼ VOL	Adjusts the volume level.
ATT	Attenuates/restores the sound.
DISP/V.SEL	Switches to the navigation screen.*1
ENTER	Enters options.
☎	Answers incoming calls.
FNC/PBC/MENU	Switches the control screen.
MODE/TOP MENU	Changes the aspect ratio. <ul style="list-style-type: none">• The aspect ratio changes each time you press this key.
OPEN	Adjusts the panel angle.*2 <ul style="list-style-type: none">• The panel angle changes each time you press this key.

*1 Available for DDX416BT only.

*2 Available for DDX793/DDX773BH only.

REMOTE CONTROLLER

❑ DVD/VCD (DVD mode)

	Moves the cursor when displaying a menu.
	Selects a track.
	Starts/pauses playback.
	Stops and memorizes the point where the disc stops.
0 – 9	<ul style="list-style-type: none"> Specifies the number to search for in direct search. : Fast forwards/backwards. <ul style="list-style-type: none"> – Fast forward/backward speed changes each time you press this key. : Slow forwards/backwards during pause.
MODE/TOP MENU	Shows the disc top menu.
FNC/PBC/MENU	Shows the disc menu.
SUBTITLE	Changes the subtitle language.
ZOOM	<ul style="list-style-type: none"> Changes the zoom ratio. The zoom ratio changes each time you press this key.
ANGLE	<ul style="list-style-type: none"> Changes the picture angle. The picture angle changes each time you press this key.
AUDIO	<ul style="list-style-type: none"> Changes the voice language. The voice language changes each time you press this key.
DIRECT	Enters direct search mode. (See the far right column.)
CLEAR	Deletes a character while in direct search mode.

❑ Music Disc/Audio file/Video file/Picture file (AUD mode)

AM –/FM +	Selects a folder.
	Selects a track/file.
	Starts/pauses playback.
0 – 9	Specifies the number to search for in direct search.
DIRECT	Enters direct search mode. (See the right column.)

❑ Radio/HD Radio*1/SiriusXM*2 (AUD mode)

AM –/FM +	Selects the band.
	Searches for stations.
	Changes the seek mode (AUTO1, AUTO2, MANU).
0 – 9	<ul style="list-style-type: none"> Specifies preset number. (–) Specifies the frequency of the station to receive to search for in direct search.
DIRECT	Enters direct search mode. (See the right column.)

*1 Only for DDX793/DDX773BH/DDX593/DDX573BH.

*2 Only for DDX793/DDX773BH/DDX593/DDX573BH/DDX393/DDX373BT.

❑ iPod/Android (AUD mode)

	Selects music/videos.
	Starts/pauses playback.

❑ USB (AUD mode)

AM –/FM +	Selects a folder.
	Selects a file.
	Starts/pauses playback.

Searching for an item (chapter/title/folder/file/track) directly

- Press DIRECT to enter the search mode. Each time you press DIRECT, the item to search for changes.
- Press a number button to select a desired item.
- Press ENTER to confirm the selection.

Searching for a tuner frequency directly

- Press DIRECT to enter the search mode.
- Press number buttons to enter a frequency.
- Press to confirm the entry.

REMOTE CONTROLLER

Using the steering remote controller (Only for DDX416BT)

You can assign functions to the keys of the remote controller on the steering wheel.

- This function is available only when your vehicle is equipped with the electrical steering remote controller.
- You can only register/change the functions while you are parked.
- If your steering remote controller is not compatible, learning may not be completed and an error message may appear.

□ Registering/changing the functions

- 1 Display the <System> setting screen. On the Home screen:



- 2 Display the <Steering Remote Control Setting> screen.
 - Press [▼] repeatedly to change the page on the <System> menu screen.

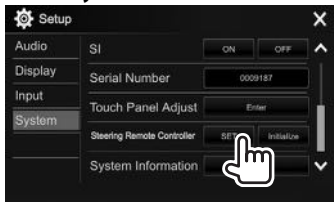

- 3 Press and hold a steering remote controller button to register/change.
- 4 Select a function to assign.

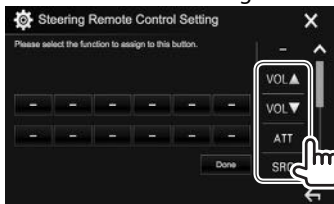

- You can change the page to display more items by pressing [▲]/[▼].

- 5 Repeat steps 3 and 4 as necessary.
- 6 Finish the procedure.

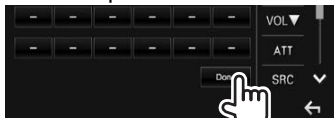

- The unit can register/change all of the buttons' functions at the same time. To do this, press each button in turn and after pressing all of them, press [Done] on the <Steering Remote Control Setting> screen. However, new functions cannot be learned after this operation.
- When changing the functions already learned, touch the button you want to change in step 3 and then touch to select the new function from the function list.
- Confirm the contents of the settable functions in the function list. You cannot edit the function list.

□ Initializing the settings

- 1 Display the <System> setting screen. (See the far left column.)
 - Press [▼] repeatedly to change the page on the <System> menu screen.



- To cancel the initialization, press [No].

CONNECTION/INSTALLATION

Before installing the unit

⚠ WARNING

- If you connect the ignition wire (red) and the battery wire (yellow) to the car chassis (ground), you may cause a short circuit, that in turn may start a fire. Always connect those wires to the power source running through the fuse box.
- Do not cut out the fuse from the ignition wire (red) and the battery wire (yellow). The power supply must be connected to the wires via the fuse.

⚠ Precautions on installation and connection

- Mounting and wiring this product requires skills and experience. For best safety, leave the mounting and wiring work to professionals.
- Make sure to ground the unit to a negative 12 V DC power supply.
- Do not install the unit in a location exposed to direct sunlight or excessive heat or humidity. Also avoid places with too much dust or the possibility of water splashing.
- Do not use your own screws. Use only the screws provided. If you use the wrong screws, you could damage the unit.
- If the power is not turned on ("Miswiring DC Offset Error", "Warning DC Offset Error" is displayed), the speaker wire may have a short circuit or have touched the chassis of the vehicle and the protection function may have been activated. Therefore, the speaker wire should be checked.
- Keep all cables away from heat dissipate metal parts.

- If your car's ignition does not have an ACC position, connect the ignition wires to a power source that can be turned on and off with the ignition key. If you connect the ignition wire to a power source with a constant voltage supply, such as with battery wires, the battery may be drained.
- Only for DDX793/DDX773BH:
If the console has a lid, make sure to install the unit so that the monitor panel will not hit the lid when closing and opening.
- If the fuse blows, first make sure the wires are not touching to cause a short circuit, then replace the old fuse with one with the same rating.
- Insulate unconnected wires with vinyl tape or other similar material. To prevent a short circuit, do not remove the caps on the ends of the unconnected wires or the terminals.
- Connect the speaker wires correctly to the terminals to which they correspond. The unit may be damaged or fail to work if you share the ⊖ wires or ground them to any metal part in the car.
- When only two speakers are being connected to the system, connect both connectors either to the front output terminals or to the rear output terminals (do not mix front and rear). For example, if you connect the ⊕ connector of the left speaker to a front output terminal, do not connect the ⊖ connector to a rear output terminal.
- After the unit is installed, check whether the brake lamps, blinkers, wipers, etc. on the car are working properly.
- Mount the unit so that the mounting angle is 30° or less.
- Do not press hard on the panel surface when installing the unit to the vehicle. Otherwise scratches, damage, or failure may result.

⚠ CAUTION

Install this unit in the console of your vehicle. Do not touch the metal parts of this unit during and shortly after the use of the unit. Metal parts such as the heat sink and enclosure become hot.

▣ Supplied accessories for installation

- ① Wiring harness x 1
- ② Trim plate x 1
- ③ Extension wire (2 m) x 1
- ④ Extraction keys x 2 *1
- ⑤ Flat head screws (M5 x 8 mm) x 6
- ⑥ Round head screws (M5 x 8 mm) x 6
- ⑦ Microphone (3 m) x 1
- ⑧ Steering Remote cable x 1 *2

*1 Only for DDX793/DDX773BH/DDX593/DDX573BH/DDX393/DDX373BT/DDX23BT.

*2 Only for DDX416BT.

CONNECTION/INSTALLATION

❑ Installation procedure

- 1 To prevent a short circuit, remove the key from the ignition and disconnect the \ominus battery.
- 2 Make the proper input and output wire connections for each unit.
- 3 Connect the speaker wires of the wiring harness.
- 4 Connect the wiring harness wires in the following order: ground, battery, ignition.
- 5 Connect the wiring harness connector to the unit.
- 6 Install the unit in your car.
 - Make sure that the unit is installed securely in place. If the unit is unstable, it may malfunction (eg, the sound may skip).
- 7 Reconnect the \ominus battery.
- 8 Press the reset button. (Page 3)
- 9 Configure <Initial Setup>. (Page 4)

Installing the unit

- ❑ Installing the unit (only for DDX793/DDX773BH/DDX593/DDX573BH/DDX393/DDX373BT/DDX23BT)

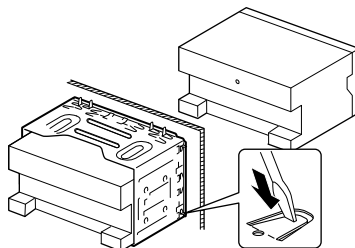

- Bend the tabs of the mounting sleeve with a screwdriver or similar utensil and attach it in place.

- ❑ Installing the unit using the mounting bracket removed from the car

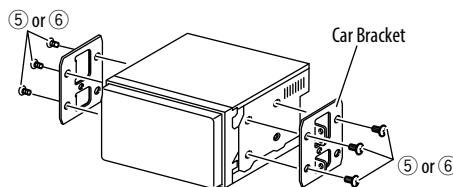

- Select the appropriate type of screw for the mounting bracket: flat head (5) or round head (6).

- ❑ Installing the trim plate

- 1 Attach the trim plate (2).

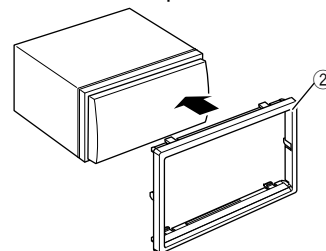

CONNECTION/INSTALLATION

❑ Connecting a USB device

USB device*
(commercially available)

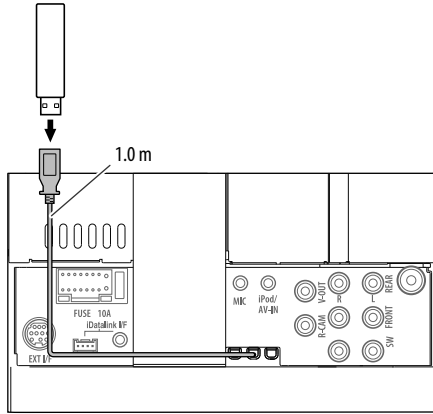

* Use CA-U1EX for extending the cable if necessary. (Max 500 mA, 5V)

❑ Connecting an Android device

Android device (commercially available)

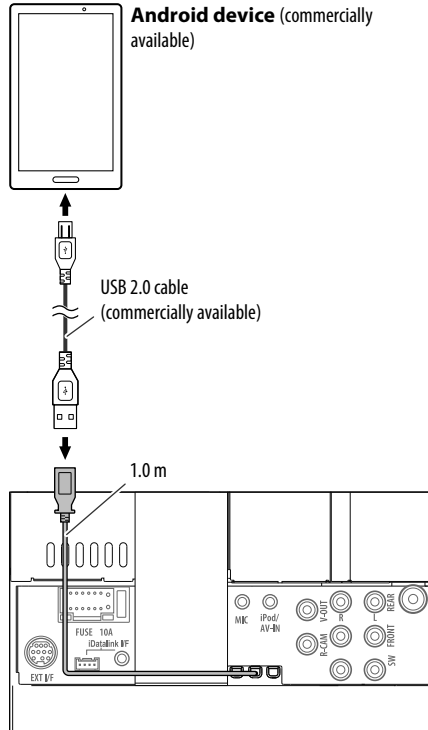

❑ Connecting iPod/iPhone

iPod/iPhone (Lightning connector models)
(commercially available)

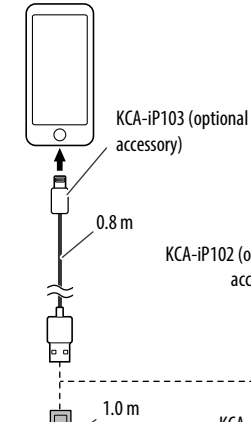

iPod/iPhone (30-pin connector models)
(commercially available)

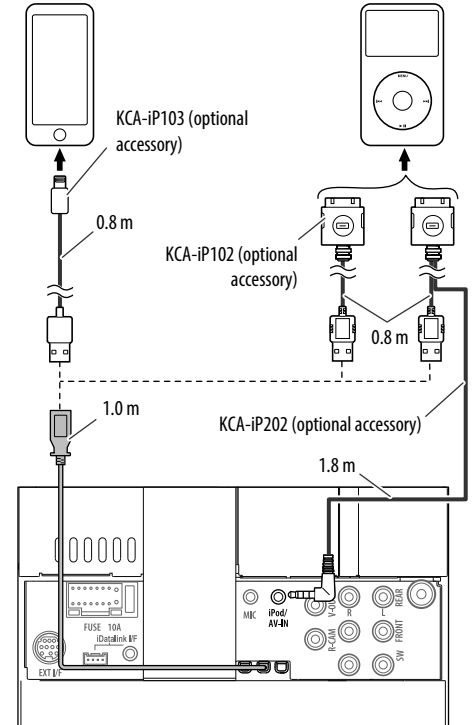

CONNECTION/INSTALLATION

Connecting external components

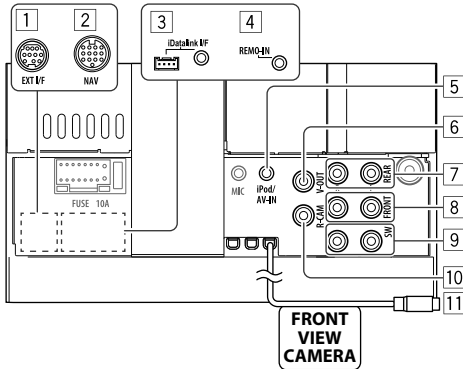

- 1 Expansion port for connecting SiriusXM Connect Vehicle Tuner (commercially available)*1
- 2 NAVI I/F input*2
- 3 iDataLink input for connecting ADS adapter (commercially available)*3
- 4 Steering wheel remote controller input*2
 - Connect to the vehicle's steering remote harness using the Steering Remote cable (8). Contact your Kenwood dealer for details.
- 5 iPod/Audio Video input (iPod/AV-IN)*4
- 6 Video output (Yellow)
- 7 Rear preout*5
 - Audio left output (White)
 - Audio right output (Red)

- 8 Front preout*5
 - Audio left output (White)
 - Audio right output (Red)
- 9 Subwoofer preout*5
 - Subwoofer left output (White)
 - Subwoofer right output (Red)
- 10 Rear view camera input (Yellow)
- 11 Front view camera input*3

*1 Only for DDX793/DDX773BH/DDX593/DDX573BH/DDX393/DDX373BT.

*2 Only for DDX416BT.

*3 Only for DDX793/DDX773BH/DDX593/DDX573BH/DDX393.

*4 When connecting the component to play on "AV-IN", use the Audio and Video cable CA-C3AV (optional accessory).

*5 When connecting an external amplifier, connect its ground wire to the chassis of the car; otherwise the unit may be damaged.

Connecting microphone for Bluetooth

Connect the microphone (7) to the MIC terminal.

- To install the microphone, peel off the adhesive tape, fix on the installation position, then adjust the direction of the microphone to face the driver. After installing, fix the microphone cable to the car with clamps (commercially available).

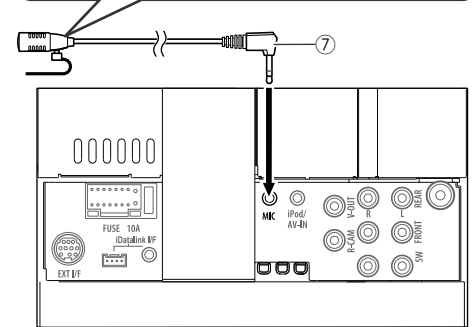
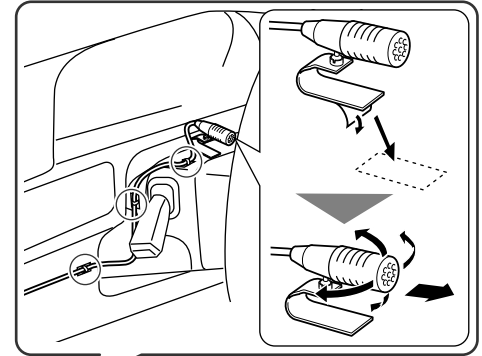

CONNECTION/INSTALLATION

Removing the unit (Only for DDX793/
DDX773BH/DDX593/DDX573BH/DDX393/
DDX373BT/DDX23BT)

❑ Removing the trim plate

- 1 Engage the catch pins on the extraction key (④) and remove the two locks on the lower part. Lower the frame and pull it forward.

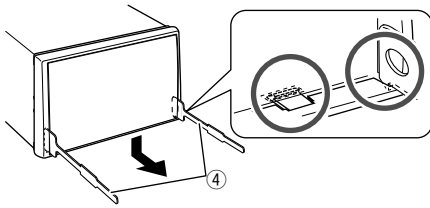

- 2 Remove from the upper two catches.

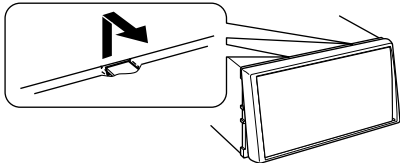

- The frame can be removed from the top side in the same manner.

❑ Removing the unit

- 1 Remove the trim plate. (See the left column.)
- 2 Insert the two extraction keys (④), then pull them as illustrated so that the unit can be removed.

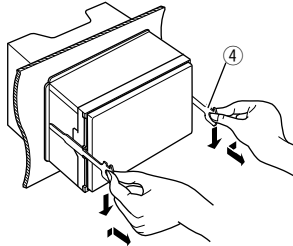

- Be careful to avoid injury from the catch pins on the extraction key.

REFERENCES

Maintenance

❑ Caution on cleaning the unit

Do not use any solvent (for example, thinner, benzine, etc.), detergent, or insecticide. This may damage the monitor or the unit.

Recommended cleaning method:

Gently wipe the panel with a soft, dry cloth.

❑ Moisture condensation

Moisture may condense on the lens inside the unit in the following cases:

- After starting the heater in the car.
- If it becomes very humid inside the car.

Should this occur, the unit may malfunction. In this case, eject the disc and leave the unit turned on for a few hours until the moisture evaporates.

❑ How to handle discs

- When removing a disc from its case, press down the center holder of the case and lift the disc out, holding it by the edges.



- Always hold the disc by the edges. Do not touch its recording surface.
- When storing a disc in its case, gently insert the disc around the center holder (with the printed surface facing up).
 - Make sure to store discs in their cases after use.

❑ To keep discs clean

Dirty discs may not play correctly.

If a disc does become dirty, wipe it with a soft cloth in a straight line from the center to the edge.



- Do not use any solvents (for example, conventional record cleaner, spray, thinner, benzine, etc.) to clean discs.

❑ To play new discs

New discs may have some rough spots around the inner and outer edges. If such a disc is used, this unit may reject the disc.



- To remove these rough spots, rub the edges with a pencil or ball-point pen, etc.

More information

❑ File playback

Playing DivX files*

- This unit can play back DivX files with the extension code <.divx>, <.div>, or <.avi> (regardless of the letter case—upper/lower).
- Audio streams should conform to MP3 or Dolby Digital.
- Files encoded in the interlaced scanning mode may not be played back correctly.
- The maximum bit rate for video signals (average) is 8 Mbps.

* Only for DDX416BT.

Playing MPEG1/MPEG2 files

- This unit can play back MPEG1/MPEG2 files with the extension code <.mpg>, <.mpeg>.
- The stream format should conform to MPEG system/program stream.
The file format should be MP@ML (Main Profile at Main Level)/SP@ML (Simple Profile at Main Level)/MP@LL (Main Profile at Low Level).
- Audio streams should conform to MPEG1 Audio Layer-2 or Dolby Digital.

Playing JPEG files

- This unit can play back picture files with the extension code <.jpg> or <.jpeg>.
- This unit can play back files that are at 32 x 32 to 8 192 x 7 680 resolution.
It may take time to display the file depending on its resolution.
- This unit can play back baseline JPEG files.
Progressive JPEG files or lossless JPEG files cannot be played.

REFERENCES

Playing audio files (MP3/WMA/WAV/AAC)

- This unit can play back files with the extension code <.mp3>, <.wma>, <.wav> or <.m4a> (regardless of the letter case—upper/lower).
- This unit can play back files that meet the conditions below:
 - Bit rate:
 - MP3: 8 kbps – 320 kbps
 - WMA: 5 kbps – 320 kbps
 - AAC: 16 kbps – 320 kbps
 - Sampling frequency:
 - 8 kHz – 48 kHz (for MP3/WMA)
 - 44.1 kHz (for WAV)
 - 32 kHz – 48 kHz (for AAC)
- This unit can show ID3 Tag Version 1.0/1.1/2.2/2.3/2.4 (for MP3).
- This unit can also show WMA/WAV/AAC Tag.
- This unit can play back files recorded in VBR (variable bit rate).
- Files recorded in VBR have a discrepancy in elapsed time indication.
- This unit cannot play back the following files:
 - MP3 files encoded with MP3i and MP3 PRO format.
 - MP3 files encoded with Layer 1/2.
 - WMA files encoded with lossless, professional, and voice format.
 - WMA files which are not based upon Windows Media® Audio.
 - WMA/AAC files copy-protected with DRM.
 - AAC files encoded using any other application than iTunes.
 - AAC files copy-protected with FairPlay (except those stored on an iPod/iPhone).
 - Files which have data such as AIFF, ATRAC3, etc.

- This unit can display jacket pictures that meet the conditions below:
 - Picture size: 32 x 32 to 1 232 x 672 resolution
 - Data size: less than 500 KB
 - File type: JPEG

Disc playback

Playable disc types

Disc type	Recording format, file type, etc.
DVD <ul style="list-style-type: none"> • DTS sound cannot be reproduced or emitted from this unit. 	DVD Video* ¹
DVD Recordable/Rewritable (DVD-R/-RW*², +R/+RW*³) <ul style="list-style-type: none"> • DVD Video: UDF bridge • DivX*⁴/MPEG1/MPEG2/MP3/WMA/WAV/AAC: ISO 9660 level 1, level 2, Romeo, Joliet 	<ul style="list-style-type: none"> • DVD Video • DivX*⁴/MPEG1/MPEG2/JPEG • MP3/WMA/WAV/AAC
Dual Disc	DVD side
CD/VCD	<ul style="list-style-type: none"> • VCD (Video CD) • Audio CD/CD Text (CD-DA)
CD Recordable/Rewritable (CD-R/-RW) <ul style="list-style-type: none"> • ISO 9660 level 1, level 2, Romeo, Joliet 	<ul style="list-style-type: none"> • VCD (Video CD) • CD-DA • DivX*⁴/MPEG1/MPEG2/JPEG • MP3/WMA/WAV/AAC

*¹ DVD Region code:

For DDX793/DDX773BH/DDX593/DDX573BH/DDX393/DDX373BT/DDX238T: 1

For DDX416BT: 4

If you insert a DVD Video disc of an incorrect Region Code, "Region Code Error" appears on the screen.

*² DVD-R recorded in multi-border format are also playable (except for dual layer discs). DVD-RW dual layer discs are not playable.

*³ It is possible to play back finalized +R/+RW (Video format only) discs. "DVD" is selected as the disc type when a +R/+RW disc is loaded. +RW double layer discs are not playable.

*⁴ Only for DDX416BT.

REFERENCES

Unplayable discs

- Unplayable disc types and formats are as follows:
 - DVD-Audio/DVD-ROM discs
 - MPEG4/DivX*/FLAC/MKV/DVD–VR/DVD+VR/DVD-RAM recorded on DVD-R/RW or +R/+RW
 - SVCD (Super Video CD), CD-ROM, CD-I (CD-I Ready), DTS-CD
 - MPEG4/DivX*/FLAC/MKV recorded on CD-R/RW
- Discs that are not round.
- Discs with coloring on the recording surface or discs that are dirty.
- Recordable/Rewritable discs that have not been finalized.
- 3 inch discs. Attempting to insert these discs using an adapter may cause a malfunction.

* Only for DDX793/DDX773BH/DDX593/DDX573BH/DDX393/DDX373BT/DDX23BT.

DualDisc playback

The Non-DVD side of a “DualDisc” does not comply with the “Compact Disc Digital Audio” standard. Therefore, the use of the Non-DVD side of a DualDisc on this product cannot be recommended.

Playing Recordable/Rewritable discs

- This unit can recognize a total of 5 000 files and 250 folders (a maximum of 999 files per folder).
- Use only “finalized” discs.
- This unit can play back multi-session discs; however, unclosed sessions will be skipped while playing.
- Some discs or files may not be played back due to their characteristics or recording conditions.

□ About data stored in the connected USB device/iPod/iPhone/Android/BlackBerry

- We bear no responsibility for any loss of data in iPod/iPhone, Android, BlackBerry, and USB mass storage class devices while using this unit.

□ USB playback

Playable files on a USB device

- This unit can play the following types of files stored in a USB mass storage class device.
 - JPEG/DivX*/MPEG1/MPEG2/MP3/WMA/WAV/AAC
- This unit can recognize a total of 5 000 files and 250 folders (a maximum of 999 files per folder).
- Make sure all important data has been backed up to avoid losing the data.

* Only for DDX416BT.

Notes on using a USB device:

- This unit may not play back files in a USB device properly when using a USB extension cable.
- USB devices equipped with special functions such as data security functions cannot be used with the unit.
- Do not use a USB device with 2 or more partitions.
- Depending on the shape of the USB devices and connection ports, some USB devices may not be attached properly or the connection might be loose.
- This unit may not recognize a memory card inserted into a USB card reader.
- When connecting with a USB cable, use a USB 2.0 cable.

- The maximum number of characters (when the characters are 1 byte):
 - Folder names: 50 characters
 - File names: 50 characters
- Avoid using the USB device if it might affect driving safety.
- Do not pull out and connect the USB device repeatedly while “Reading” is shown on the screen.
- Electrostatic shock at connecting a USB device may cause abnormal playback of the device. In this case, disconnect the USB device then reset this unit and the USB device.
- Operation and power supply may not work as intended for some USB devices.
- Do not leave a USB device in the car, or expose to direct sunlight or high temperatures to prevent deformation or damage to the device.

□ Notes on playing iPod/iPhone

- iPod/iPhone that can be connected to this unit:
 - Made for
 - iPod with video
 - iPod classic
 - iPod nano (7th Generation)*
 - iPod nano (6th Generation)
 - iPod nano (5th Generation)
 - iPod nano (4th Generation)
 - iPod nano (3rd Generation)*
 - iPod touch (5th Generation)*
 - iPod touch (4th Generation)
 - iPod touch (3rd Generation)
 - iPhone 6 Plus*
 - iPhone 6*
 - iPhone 5S*

REFERENCES

- iPhone 5C*
- iPhone 5*
- iPhone 4S
- iPhone 4
- iPhone 3GS
- iPhone 3G
- iPhone

- * You cannot watch video when connecting Lightning connector models.
- When operating an iPod/iPhone, some operations may not be performed correctly or as intended.
- For some iPod/iPhone models, the performance may be abnormal or unstable during operation. In this case, disconnect the iPod/iPhone device, then check its condition.
If the performance is not improved or slow, reset your iPod/iPhone.
- When you turn on this unit, the iPod/iPhone is charged through the unit.
- The text information may not be displayed correctly.

Notes on using BlackBerry device

Compatible BlackBerry device

This unit supports BlackBerry OS 10.1 and above.

Language codes (for DVD language selection)

AA	Afar	GL	Galician	MI	Maori	SO	Somali
AB	Abkhazian	GN	Guarani	MK	Macedonian	SQ	Albanian
AF	Afrikaans	GU	Gujarati	ML	Malayalam	SR	Serbian
AM	Ameharic	HA	Hausa	MN	Mongolian	SS	Siswati
AR	Arabic	HI	Hindi	MO	Moldavian	ST	Sesotho
AS	Assamese	HR	Croatian	MR	Marathi	SU	Sundanese
AY	Aymara	HU	Hungarian	MS	Malay (MAY)	SW	Swahili
AZ	Azerbaijani	HY	Armenian	MT	Maltese	TA	Tamil
BA	Bashkir	IA	Interlingua	MY	Burmese	TE	Telugu
BE	Byelorussian	IE	Interlingue	NA	Nauru	TG	Tajik
BG	Bulgarian	IK	Inupiak	NE	Nepali	TH	Thai
BH	Bihari	IN	Indonesian	NO	Norwegian	TI	Tigrinya
BI	Bislama	IS	Icelandic	OC	Occitan	TK	Turkmen
BN	Bengali, Bangla	IW	Hebrew	OM	(Afan) Oromo	TL	Tagalog
BO	Tibetan	JA	Japanese	OR	Oriya	TN	Setswana
BR	Breton	JI	Yiddish	PA	Panjabi	TO	Tonga
CA	Catalan	JW	Javanese	PL	Polish	TR	Turkish
CO	Corsican	KA	Georgian	PS	Pashto, Pushto	TS	Tsonga
CS	Czech	KK	Kazakh	QU	Quechua	TT	Tatar
CY	Welsh	KL	Greenlandic	RM	Rhaeto-Romance	TW	Twi
DZ	Bhutani	KM	Cambodian	RN	Kirundi	UK	Ukrainian
EL	Greek	KN	Kannada	RO	Rumanian	UR	Urdu
EO	Esperanto	KO	Korean (KOR)	RW	Kinyarwanda	UZ	Uzbek
ET	Estonian	KS	Kashmiri	SA	Sanskrit	VI	Vietnamese
EU	Basque	KU	Kurdish	SD	Sindhi	VO	Volapuk
FA	Persian	KY	Kirghiz	SG	Sangho	WO	Wolof
FI	Finnish	LA	Latin	SH	Serbo-Croatian	XH	Xhosa
FJ	Fiji	LN	Lingala	SI	Singhalese	YO	Yoruba
FO	Faroese	LO	Laothian	SK	Slovak	ZU	Zulu
FY	Frisian	LT	Lithuanian	SL	Slovenian		
GA	Irish	LV	Latvian, Lettish	SM	Samoan		
GD	Scots Gaelic	MG	Malagasy	SN	Shona		

REFERENCES

Error message list

If an error occurs while using the unit, a message appears. Take appropriate action according to the following message/remedy/cause list.

“No Signal”/“No Video Signal”:

- Start playback on the external component connected to the iPod/AV-IN input terminal.
- Check the cords and connections.
- Signal input is too weak.

“Miswiring DC Offset Error”/“Warning DC Offset Error”:

- A speaker cord has shorted or it has come into contact with the car chassis. Wire or insulate the speaker cord as appropriate, then reset the unit. (Pages 3 and 68)

“Parking off”:

- No playback picture is shown when the parking brake is not engaged.

“Authorization Error”:

- Check whether the connected iPod/iPhone is compatible with this unit. (Page 74)

“USB Device Error”:

- The USB power voltage is abnormal.
- Turn off and turn on the unit.
- Connect another USB device.

“Panel Mecha Error”:

- The panel does not work properly. Reset the unit.

“No Navigation”:

- No navigation unit is connected.

“Connection Error”:

- The device is registered but the connection has failed. Connect the registered device. (Page 45)

“Please Wait...”:

- The unit is preparing to use the Bluetooth function. If the message does not disappear, turn off and turn on the unit, then connect the device again (or reset the unit).

“No Voice Device”:

- The connected mobile phone does not have a voice recognition system.

“No Data”:

- No phone book data is contained in the connected Bluetooth phone.

“Initialize Error”:

- The unit has failed to initialize the Bluetooth module. Try the operation again.

“Dial Error”:

- Dialing has failed. Try the operation again.

“Hung Up Error”:

- The call has not ended yet. Park your car, and use the connected mobile phone to end the call.

“Pick Up Error”:

- The unit has failed to receive a call.

“Please update Pandora App”:

- The Pandora application on your iPod touch/iPhone/Android/BlackBerry is not the latest version. Update the application.

“Please check device.”:

- The Pandora application on your iPod touch/iPhone/Android/BlackBerry is not started up.
- The Pandora application is not installed on the connected device.
- An error has occurred on the Pandora application.

“Login Error”:

- You have not been signed into Pandora.

“No skips remaining”:

- No more songs can be skipped.

“Failed to save your thumb rating”:

- Thumb-up/down is prohibited.

“No Station”:

- No station is available.

“No Active Station”:

- No station is being played.

“Station limit reached”:

- The Station List is full and no more stations can be registered.

“Failed to save your bookmark”:

- The unit has failed to save a bookmark. Try the operation again.

“Limited Connectivity”:

- The connection with the Pandora application cannot be established.

“Pandora not available”:

- You cannot use the Pandora application from the area where you are currently trying to access Pandora.

“Try again later”:

- The Pandora server is under maintenance.

“Station does not exist”:

- The selected station has been deleted by another device or has expired.

REFERENCES

“Cannot create a Station”:

- You cannot create a station during the read-only mode or when network connection is not established.

“SXM No Signal”:

- Make sure the SiriusXM Satellite Radio antenna is mounted outside the vehicle. Move the vehicle to an area with a clear view of the sky.

“SXM Check Antenna”:

- Check the SiriusXM Satellite Radio antenna connection, and make sure the antenna is firmly attached to the tuner.
- Check whether the SiriusXM Satellite Radio antenna cable is bent or broken. If it is damaged, replace the whole antenna unit.

“SXM Check Tuner”:

- Make sure the SiriusXM Connect Vehicle Tuner is connected to the unit.

“SXM Chan Unavailable” (appears on the screen for about 5 seconds, then returns to the previous channel):

- The selected channel is no longer available. Select another channel or continue listening to the previous channel.

“SXM Ch Unsubscribed” (appears on the screen for about 5 seconds, then returns to the previous channel):

- The selected channel is not part of your current subscription plan.

“SXM Subscription Updated – Press Return to Continue”:

- Your subscription has been updated. Press the appropriate button to continue.

“SXM Channel Locked”

- The selected channel has been locked by the parental controls. Enter the unlock code when you are asked. (Page 37)

“SXM Incorrect Lock Code”

- The selected channel is a mature or parental lock channel, and locked by the parental lock or user lock code. Enter the correct lock code.

Troubleshooting

What appears to be trouble is not always serious. Check the following points before calling a service center.

- For operations with the external components, refer also to the instructions supplied with the adapters used for the connections (as well as the instructions supplied with the external components).

□ General

No sound comes out of the speakers.

- Adjust the volume to the optimum level.
- Check the cords and connections.

No picture is displayed on the screen.

- Turn on the screen. (Page 9)

The unit does not work at all.

- Reset the unit. (Page 3)

The remote controller* does not work.

- Replace the battery.

* For DDX793/DDX773BH/DDX593/DDX573BH/DDX393/DDX373BT/DDX23BT: Purchase KNA-RCDV331 separately.

□ Discs

Recordable/Rewritable discs cannot be played back.

- Insert a finalized disc.
- Finalize the discs with the component which you used for recording.

Tracks on the Recordable/Rewritable discs cannot be skipped.

- Insert a finalized disc.
- Finalize the discs with the component which you used for recording.

Playback does not start.

- The format of files is not supported by the unit.

No picture appears on the external monitor.

- Connect the video cord correctly.
- Select the correct input on the external monitor.

DivX*/MPEG1/MPEG2/MP3/WMA/WAV/AAC discs cannot be played back.

- Record the tracks using a compatible application on the appropriate discs. (Page 73)
- Add appropriate extension codes to the file names.

Tracks on the Recordable/Rewritable discs are not played back as you have intended them to play.

- Playback order may differ from the one played back using other players.

* Only for DDX416BT.

REFERENCES

USB

“Reading” does not disappear from the screen.

- Turn the power off and on again.

While playing a track, sound is sometimes interrupted.

- The tracks are not properly copied into the USB device. Copy the tracks again, and try again.

Tracks are not played back as you have intended them to play.

- Playback order may differ from the one played back using other players.

Android

Sound cannot be heard during playback.

- Reconnect the Android device.
- When <Android Setup> is set to [HAND MODE], launch any media player application on the Android device and start playback.

Sound output only from the Android device.

- When <Android Setup> is set to [HAND MODE], relaunch the current media player application or use another media player application.
- Restart the Android device.
- If this does not solve the problem, the connected Android device is unable to route the audio signal to unit.

Cannot playback when <Android Setup> is set to [BROWSE MODE].

- Make sure KENWOOD Music Play APP is installed on the Android device.
- Reconnect the Android device and select the appropriate control mode.
- If this does not solve the problem, the connected Android device does not support the Browse Mode.

“NO DEVICE” or “READING” keeps flashing.

- Switch off the developer options on the Android device.
- Reconnect the Android device.
- If this does not solve the problem, the connected Android device does not support the Browse Mode.

iPod/iPhone

No sound comes out of the speakers.

- Disconnect the iPod/iPhone, then connect it again.
- Select another source, then reselect “iPod”.

The iPod/iPhone does not turn on or does not work.

- Check the connecting cable and its connection.
- Update the firmware version.
- Charge the battery.
- Reset the iPod/iPhone.

Sound is distorted.

- Deactivate the equalizer either on this unit or the iPod/iPhone.

A lot of noise is generated.

- Turn off (uncheck) “VoiceOver” on the iPod/iPhone.

No operations are available when playing back a track containing artwork.

- Operate the unit after the artwork has loaded.

Videos cannot be played.

- Connect with USB Audio and Video cable KCA-iP202 (optional accessory) to iPod/iPhone 30-pin connector model. Other cables cannot be used.
- Select [USB+AV-IN] for <iPod Setup>. (Page 22)

No sound of videos comes out.

- Connect with USB Audio and Video cable KCA-iP202 (optional accessory) to iPod/iPhone 30-pin connector model. Other cables cannot be used.
- Select [USB+AV-IN] for <iPod Setup>. (Page 22)

Radio

AME automatic presetting does not work.

- Store stations manually. (Page 30)

Static noise while listening to the radio.

- Connect the antenna firmly.

AV-IN

“AV-IN” cannot be selected on the Home screen.

- Select [USB 1 Wire] for <iPod Setup>. (Page 22)

No picture appears on the screen.

- Turn on the video component if it is not on.

REFERENCES

❑ HD Radio reception (only for DDX793/DDX773BH/DDX593/DDX573BH)

Sound quality changes when receiving HD Radio stations.

- Fix the reception mode either to <Digital> or <Analog>. (Page 28)

No sound can be heard.

- The HD Radio reception mode is not appropriate. Select the appropriate mode from <Digital>, <Analog> or <Auto>.

❑ Pandora*

The application does not work.

- The application on your iPod touch/iPhone/Android/BlackBerry is not the latest version. Update the application.

* Only for DDX793/DDX773BH/DDX593/DDX573BH/DDX393/DDX373BT/DDX23BT.

❑ Bluetooth

Phone sound quality is poor.

- Reduce the distance between the unit and the Bluetooth mobile phone.
- Move the car to a place where you can get a better signal reception.

The sound is interrupted or skipped while using a Bluetooth audio player.

- Reduce the distance between the unit and the Bluetooth audio player.
- Disconnect the device connected for Bluetooth phone.
- Turn off, then turn on the unit. (When the sound is not yet restored) connect the player again.

The connected audio player cannot be controlled.

- Check whether the connected audio player supports AVRCP (Audio/Video Remote Control Profile).

The Bluetooth device does not detect the unit.

- Search from the Bluetooth device again.

The unit does not pair with the Bluetooth device.

- For devices compatible with Bluetooth 2.1: Register the device using a PIN code. (Page 44)
- For devices compatible with Bluetooth 2.0: Enter the same PIN code for both the unit and target device. If the PIN code of the device is not indicated in its instructions, try "0000" or "1234."
- Turn off, then turn on the Bluetooth device.

Echo or noise occurs.

- Adjust the microphone unit position.
- Adjust the echo volume or noise reduction volume. (Page 46)

The unit does not respond when you try to copy the phone book to the unit.

- You may have tried to copy the same entries (as stored) to the unit.

Specifications

❑ Monitor section

Picture Size (W x H)

DDX793/DDX773BH:

6.95 inches (diagonal) wide
156.6 mm × 81.6 mm
(6-3/16" × 3-3/16")

DDX593/DDX573BH/DDX416BT/DDX393/
DDX373BT/DDX23BT:

6.2 inches (diagonal) wide
137.5 mm × 77.2 mm
(5-7/16" × 3-1/16")

Display System	Transparent TN LCD panel
Drive System	TFT active matrix system
Number of Pixels	1 152 000 (800H × 480V × RGB)
Effective Pixels	99.99%
Pixel Arrangement	RGB striped arrangement
Back Lighting	LED

REFERENCES

❑ DVD player section

D/A Converter	24 bit
Audio Decoder	Linear PCM/Dolby Digital/MP3/WMA/WAV/AAC
Video Decoder	DivX*/MPEG1/MPEG2/JPEG
Wow & Flutter	Below Measurable Limit
Frequency Response	
96 kHz Sampling:	20 Hz to 22 000 Hz
48 kHz Sampling:	20 Hz to 22 000 Hz
44.1 kHz Sampling:	20 Hz to 20 000 Hz
Total Harmonic Distortion	
	0.010% (1 kHz)
Signal to Noise Ratio	
	99 dB (DVD-Video 96 kHz)
Dynamic Range	99 dB (DVD-Video 96 kHz)
Disc Format	DVD-Video/VIDEO-CD/CD-DA
Sampling Frequency	
	44.1 kHz/48 kHz/96 kHz
Quantifying Bit Number	
	16/20/24 bit

* Only for DDX416BT.

❑ USB interface section

USB Standard	USB 2.0 High Speed
Compatible Devices	Mass Storage Class
File System	FAT 16/32
Maximum Power Supply Current	DC 5 V \leq 1.5 A
D/A Converter	24 bit
Audio Decoder	MP3/WMA/AAC/WAV
Video Decoder	DivX*/MPEG1/MPEG2/JPEG

* Only for DDX416BT.

❑ Bluetooth section

Technology	Bluetooth 3.0
Frequency	2.402 GHz to 2.480 GHz
Output Power	+4 dBm (MAX), 0 dBm (AVE), Power Class 2
Maximum Communication Range	Line of sight approx. 10 m (32.8 ft)
Audio Codec	SBC/AAC/aptX*
Profile	HFP (Hands Free Profile) 1.6 A2DP (Advanced Audio Distribution Profile) 1.3 AVRCP (Audio/Video Remote Control Profile) 1.5 GAP (Generic Access Profile) PBAP (Phonebook Access Profile) 1.2 SDP (Service Discovery Profile) SPP (Serial Port Profile) 1.2

* aptX is compatible only with DDX793/DDX593.

❑ DSP section

Equalizer	
BAND	13 Band
Frequency (Hz) (BAND1-13)	62.5/100/160/250/400/630/1k/1.6k/2.5k/4k/6.3k/10k/16k
Gain	-9/-8/-7/-6/-5/-4/-3/-2/-1/0/1/2/3/4/5/6/7/8/9 dB
Q factor	1.35/1.5/2.0
2 Way X'Over	
Tweeter:	
Frequency (Hz)	1k/1.6k/2.5k/4k/5k/6.3k/8k/10k/12.5k
Gain	-8/-7/-6/-5/-4/-3/-2/-1/0 dB
Front/Rear (HPF):	
Frequency (Hz)	Through/30/40/50/60/70/80/90/100/120/150/180/220/250
Slope	-6/-12/-18/-24 dB/Oct.
Gain	-8/-7/-6/-5/-4/-3/-2/-1/0 dB
Subwoofer (LPF):	
Frequency (Hz)	30/40/50/60/70/80/90/100/120/150/180/220/250/Through
Slope	-6/-12/-18/-24 dB/Oct.
Phase	Normal/Reverse
Gain	-8/-7/-6/-5/-4/-3/-2/-1/0 dB
Position	
Front/Rear/Subwoofer Delay	0 ft to 20.0 ft (0.07 ft Step)
Gain	-8 dB to 0 dB
Subwoofer Level	-50 dB to +10 dB

REFERENCES

FM radio section

Frequency Range

DDX793/DDX773BH/DDX593/DDX573BH/
DDX393/DDX373BT/DDX23BT:

87.9 MHz to 107.9 MHz (200 kHz)

DDX416BT: 87.5 MHz to 108.0 MHz (50 kHz)

Usable Sensitivity (S/N: 30 dB)

8.2 dBf (0.71 μ V/75 Ω)

Quieting Sensitivity (S/N: 50 dB)

17.2 dBf (2.0 μ V/75 Ω)

Frequency Response (\pm 3.0 dB)

Digital: 20 Hz to 20 kHz*

Analog: 30 Hz to 15 kHz

Signal to Noise Ratio

Digital: 75 dB (STEREO)*

Analog: 64 dB (MONO)

Selectivity (\pm 400 kHz)

\geq 80 dB

Stereo Separation 40 dB (1 kHz)

* Only for DDX793/DDX773BH/DDX593/DDX573BH.

AM radio section

Frequency Range (10 kHz)

530 kHz to 1 700 kHz

Usable Sensitivity 29 dB μ

Frequency Response (\pm 3.0 dB)

Digital: 40 Hz to 15 kHz*

Signal to Noise Ratio

Digital: 75 dB (STEREO)*

* Only for DDX793/DDX773BH/DDX593/DDX573BH.

Video section

Color System of External Video Input

NTSC/PAL

External Video Input Level (mini jack)

1 Vp-p/75 Ω

External Audio Max Input Level (mini jack)

2 V/25 k Ω

Video Input Level (RCA jack)

1 Vp-p/75 Ω

Video Output Level (RCA jack)

1 Vp-p/75 Ω

Analog RGB Input 0.7 Vp-p/75 Ω *

* Only for DDX416BT.

Audio section

Maximum Power (Front & Rear)

50 W \times 4

Full Bandwidth Power (Front & Rear)

22 W \times 4 (at less than 1%THD)

Preout Level

DDX793/DDX773BH/DDX593/DDX573BH/
DDX416BT/DDX393/DDX373BT:

4 V/10 k Ω

DDX23BT: 2.5 V/10 k Ω

Preout Impedance

DDX793/DDX773BH/DDX593/DDX573BH/
DDX416BT/DDX393/DDX373BT:

\leq 600 Ω

DDX23BT: \leq 250 Ω

Speaker Impedance

4 Ω to 8 Ω

General

Operating Voltage

14.4 V (10.5 V to 16 V allowable)

Maximum Current Consumption

10 A

Installation Dimensions (W \times H \times D)

DDX793/DDX773BH/DDX593/DDX573BH/
DDX393/DDX373BT/DDX23BT:

182 mm \times 111 mm \times 165 mm
(7-3/16" \times 4-7/16" \times 6-5/16")

DDX416BT: 178mm \times 100 mm \times 162 mm

(7" \times 3-7/8" \times 6-3/8")

Operational Temperature Range

-10°C to +60°C

Operational Temperature Range

-10°C to +60°C

Weight

DDX793/DDX773BH:

2.3 kg (5.1 lbs)

DDX593/DDX573BH/DDX416BT/DDX393/
DDX373BT/DDX23BT:

1.7 kg (3.7 lbs)

Design and specifications are subject to change without notice.

REFERENCES

☐ Trademarks and licenses

- Manufactured under license from Dolby Laboratories. Dolby and the double-D symbol are trademarks of Dolby Laboratories.
- “DVD Logo” is a trademark of DVD Format/Logo Licensing Corporation registered in the US, Japan and other countries.
- The “AAC” logo is a trademark of Dolby Laboratories.
- Microsoft and Windows Media are either registered trademarks or trademarks of Microsoft Corporation in the United States and/or other countries.
- “Made for iPod,” and “Made for iPhone” mean that an electronic accessory has been designed to connect specifically to iPod, or iPhone, respectively, and has been certified by the developer to meet Apple performance standards. Apple is not responsible for the operation of this device or its compliance with safety and regulatory standards. Please note that the use of this accessory with iPod, or iPhone may affect wireless performance. iPhone, iPod, iPod classic, iPod nano, and iPod touch are trademarks of Apple Inc., registered in the U.S. and other countries.
- Lightning is a trademark of Apple Inc.
- This item incorporates copy protection technology that is protected by U.S. patents and other intellectual property rights of Rovi Corporation. Reverse engineering and disassembly are prohibited.
- Font for this product is designed by Ricoh.

- THIS PRODUCT IS LICENSED UNDER THE MPEG-4 VISUAL PATENT PORTFOLIO LICENSE FOR THE PERSONAL AND NON-COMMERCIAL USE OF A CONSUMER FOR (i) ENCODING VIDEO IN COMPLIANCE WITH THE MPEG-4 VISUAL STANDARD (“MPEG-4 VIDEO”) AND/OR (ii) DECODING MPEG-4 VIDEO THAT WAS ENCODED BY A CONSUMER ENGAGED IN A PERSONAL AND NON-COMMERCIAL ACTIVITY AND/OR WAS OBTAINED FROM A VIDEO PROVIDER LICENSED BY MPEG LA TO PROVIDE MPEG-4 VIDEO. NO LICENSE IS GRANTED OR SHALL BE IMPLIED FOR ANY OTHER USE. ADDITIONAL INFORMATION INCLUDING THAT RELATING TO PROMOTIONAL, INTERNAL AND COMMERCIAL USES AND LICENSING MAY BE OBTAINED FROM MPEG LA, LLC..
- THIS PRODUCT IS LICENSED UNDER THE AVC PATENT PORTFOLIO LICENSE FOR THE PERSONAL USE OF A CONSUMER OR OTHER USES IN WHICH IT DOES NOT RECEIVE REMUNERATION TO (i) ENCODE VIDEO IN COMPLIANCE WITH THE AVC STANDARD (“AVC VIDEO”) AND/OR (ii) DECODE AVC VIDEO THAT WAS ENCODED BY A CONSUMER ENGAGED IN A PERSONAL ACTIVITY AND/OR WAS OBTAINED FROM A VIDEO PROVIDER LICENSED TO PROVIDE AVC VIDEO. NO LICENSE IS GRANTED OR SHALL BE IMPLIED FOR ANY OTHER USE. ADDITIONAL INFORMATION MAY BE OBTAINED FROM MPEG LA, L.L.C..
- Pandora, the Pandora logo, and the Pandora trade dress are trademarks or registered trademarks of Pandora Media, Inc., used with permission.
- HD Radio Technology manufactured under license from iBiquity Digital Corporation. U.S. and Foreign Patents. HD Radio™ and the HD, HD Radio, and “Arc” logos are proprietary trademarks of iBiquity Digital Corp.

- Sirius, XM and all related marks and logos are trademarks of Sirius XM Radio Inc. All rights reserved.
- Android is a trademark of Google Inc.
- BlackBerry®, RIM®, Research In Motion® and related trademarks, names and logos are the property of Research In Motion Limited and are registered and/or used in the U.S. and countries around the world. Used under license from Research In Motion Limited.
- The Bluetooth® word mark and logos are registered trademarks owned by Bluetooth SIG, Inc. and any use of such marks by JVC KENWOOD Corporation is under license. Other trademarks and trade names are those of their respective owners.
- The aptX® software is copyright CSR plc or its group companies. All rights reserved. The aptX® mark and the aptX logo are trade marks of CSR plc or one of its group companies and may be registered in one or more jurisdictions.

DIVX

- This DivX Certified® device has passed rigorous testing to ensure it plays DivX® video. To play purchased DivX movies. Find your registration code in the DivX VOD section of your device setup menu. (Page 62)
- DivX Certified® to play DivX® video, including premium content.
- DivX®, DivX Certified® and associated logos are trademarks of DivX, LLC and are used under license.