



2011+ Ford F-250/350 2011-2014 Ford F-450 P/U 4-6" Rear Install Instructions



Installation

1. Before doing anything, measure the pinion angle and write the angle down. This is important because you will need to put the axle back to this measurement after the installation. Also, take a measurement from the front of the axle to a location on each side of the frame. Write these measurements here. Pinion angle _____. Right side _____ Left side _____ **NOTE: All the bolts in this kit use a flat washer on each side of the bolt.** It is not required to remove the bed, but if you have the ability to, it will make the install much, much easier.
2. Jack up the rear of the frame so that most of the tension is off the leaf springs. Place a set of jack stands under the frame, block the tires so the axle won't move and place a jack stand under the pinion so it doesn't rotate. Remove the leaf springs and shocks. Remove the bolts that hold the sway bar to the axle (if equipped) and let it hang from the end links. Keep the rear shackle bolt as you will use it in step 8 when installing the accumulator tanks.

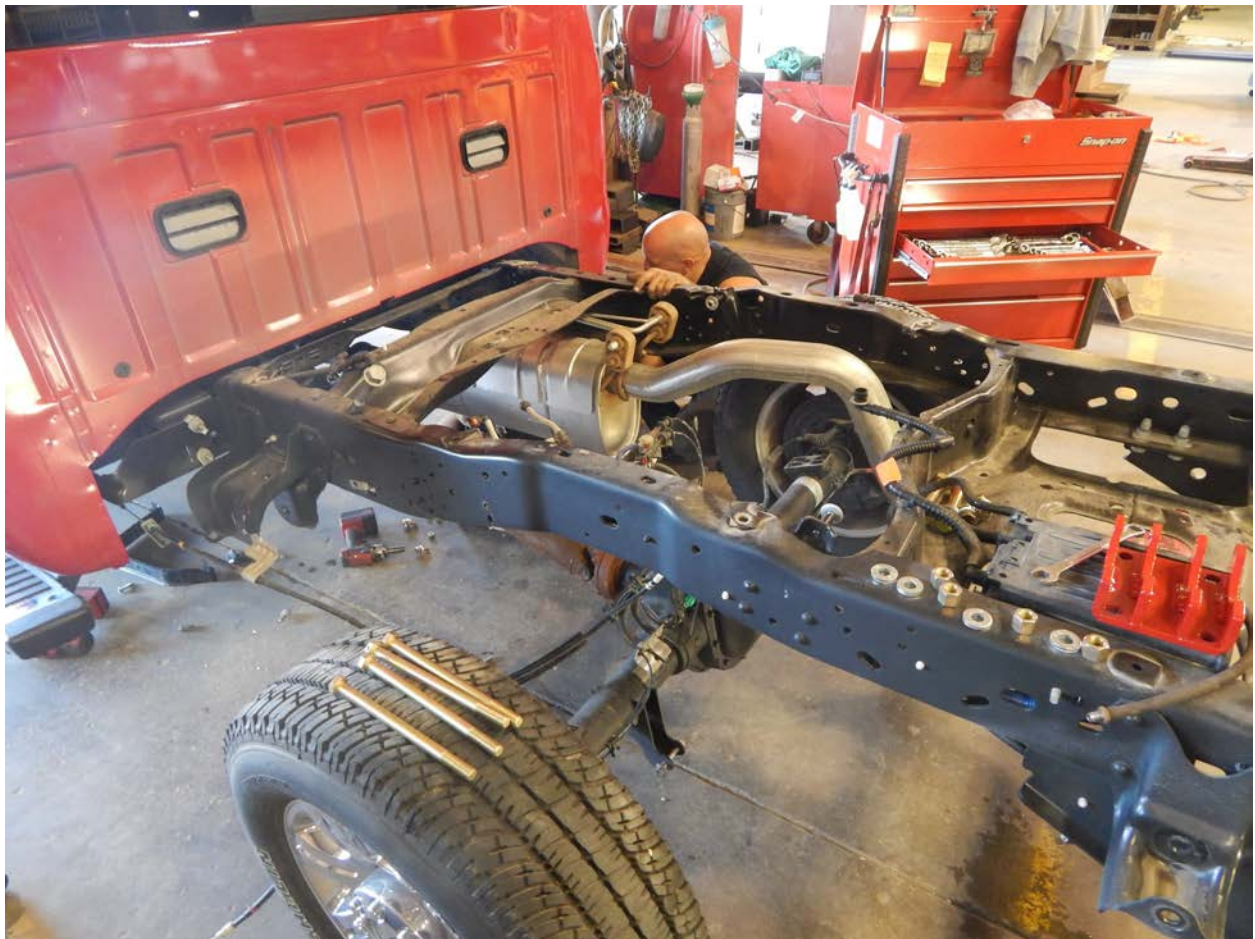

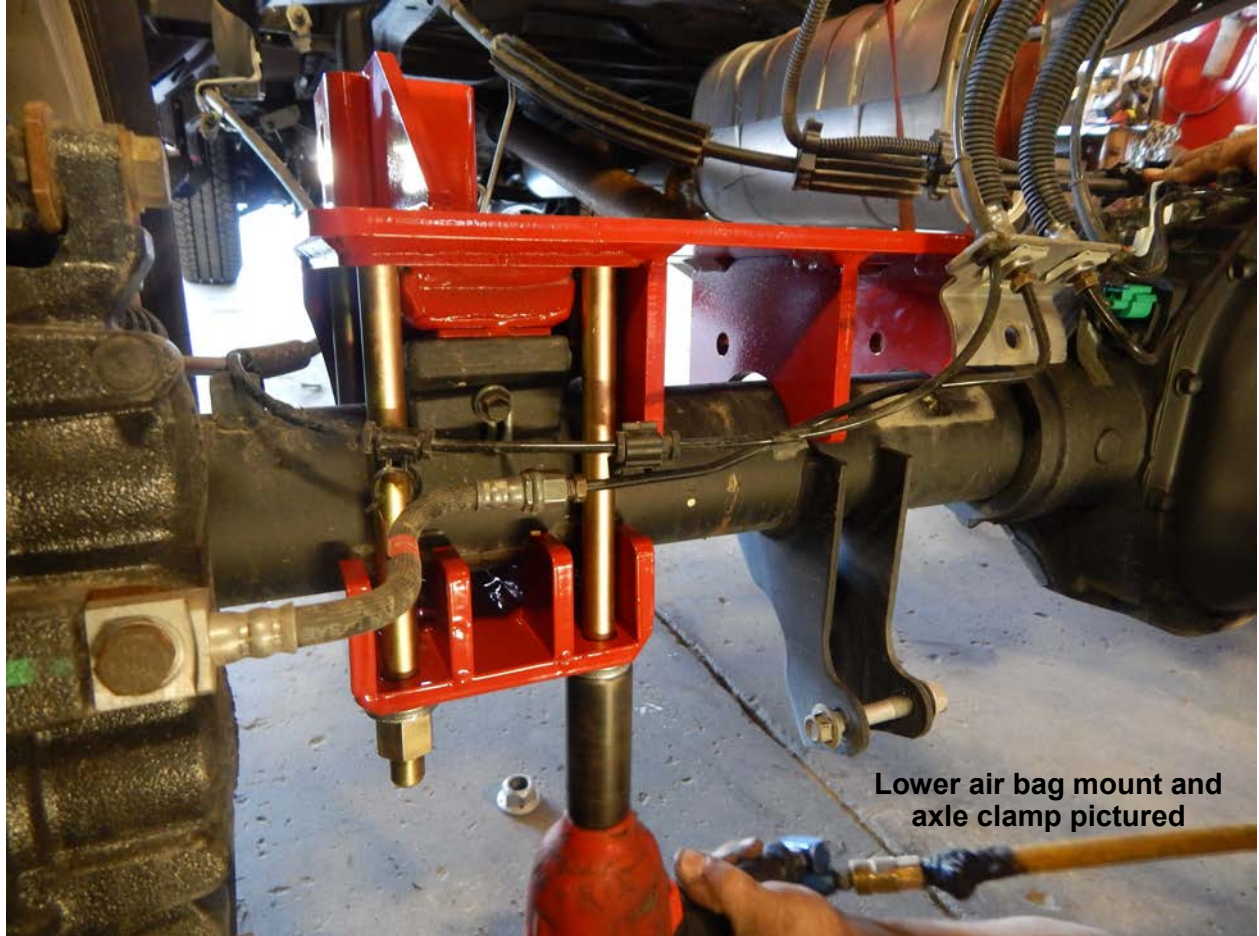

Lower air bag mount and axle clamp pictured



3. Locate the lower bag mounts (part# 70403 DSSRW and 70404PSSRW) and the lower axle clamps (part# 70402 SRW). The axle clamps fit on top of the leaf spring perches and fasten to the axle with the axle clamps and the 5/8x9" bolts. Fasten the bolts finger tight, but do not torque yet.

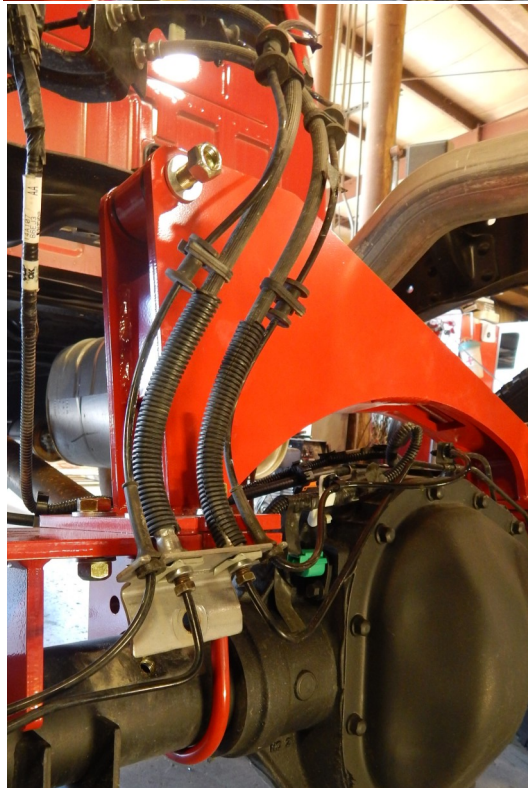
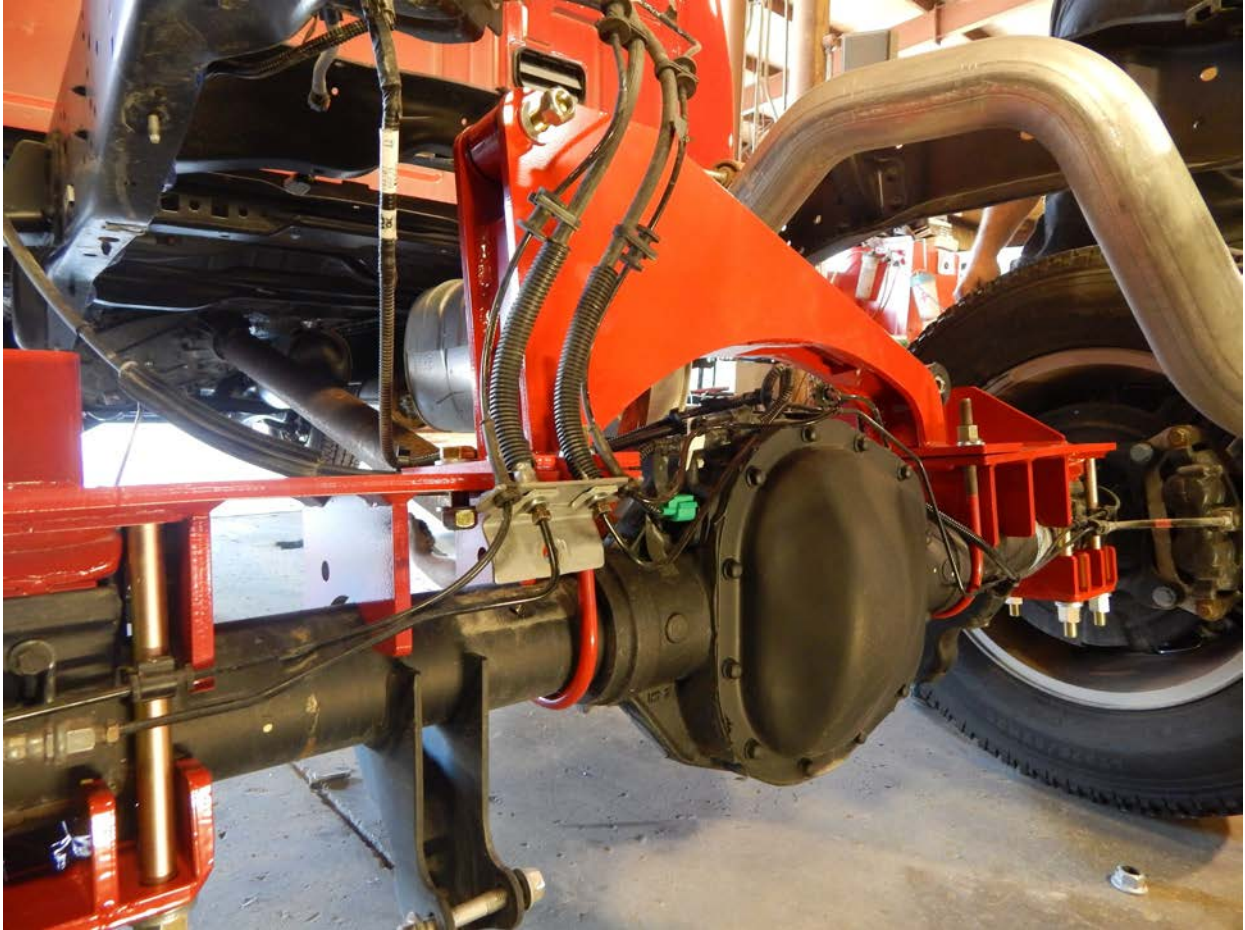

4. Locate the lower pan hard bar (cross member part# 70540). It fastens to the lower bag mounts with two 5/8x2" bolts and one 5/8" u-bolts. Once you get the bolts started you can torque the 5/8" bolts to 150 ft/lbs, including the lower bag mounts and fasten the 5/8" U bolt to 85 ft/lbs.

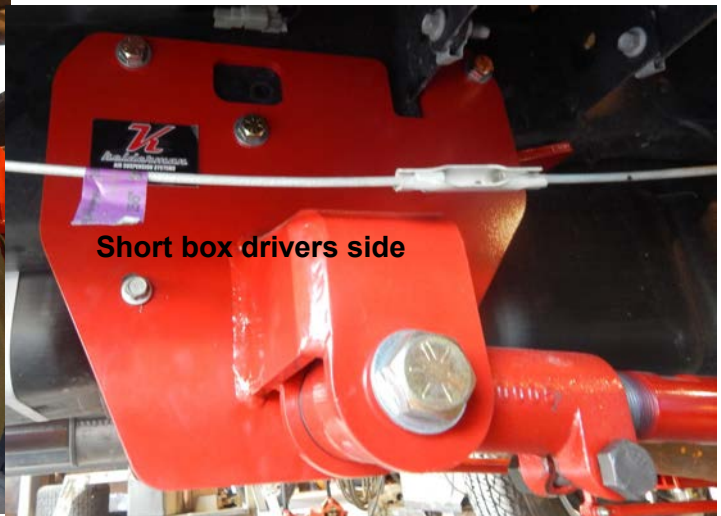

5. Locate the side plates, (part# 20154 PSSB and 20153DSSB or 20324 PPSLB and 20325 DSLB). They fasten to the frame with the one 3/4x2" bolt and four 1/2x1 1/2" bolts. **Drilling will be required.** On the drivers side you will have to notch the fuel tank cover or remove the fuel tank cover to provide enough clearance for the side plate. The fuel tank mounting strap will fasten to the side plate instead of the side of the frame. The short box side plates have a slot cut out to fit around the cab mounts.

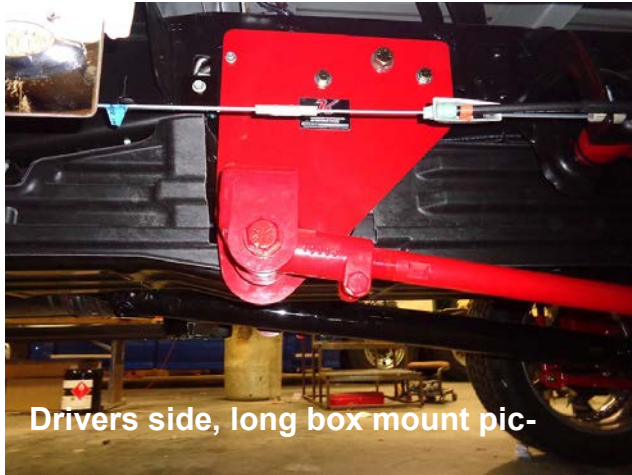

Drivers side, long box mount pic-



Passenger side short box

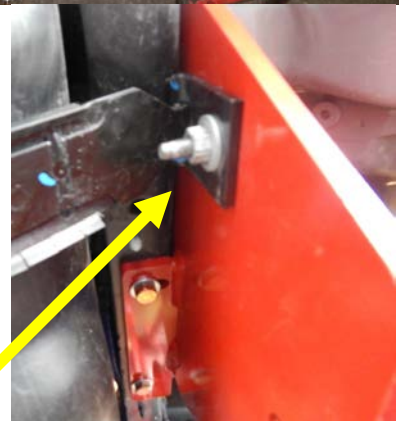

The gas short box truck will need the tank strap mounted to the trailing arm mount. Use the strap to figure out where to drill the hole. Make sure the mount is tightened in place.

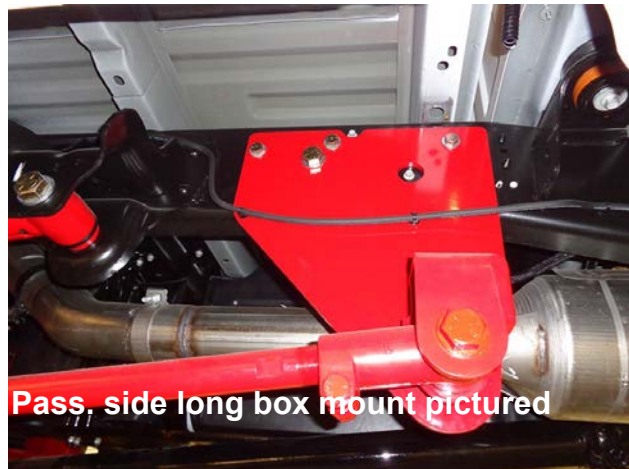

Pass. side long box mount pictured

Notch the fuel tank cover for clearance for the forward trailing arm side mount (long box, drivers side). On short box trucks its just as easy

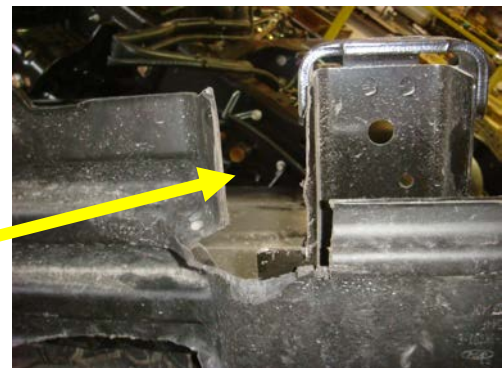

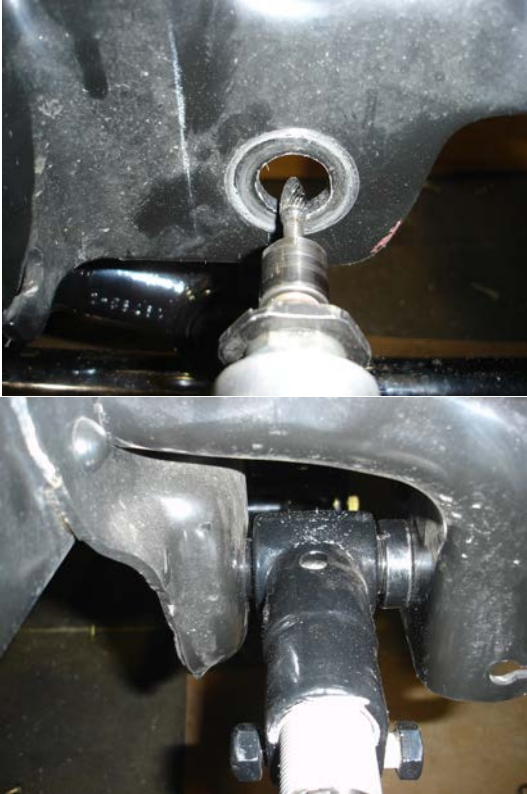

6. Locate the trailing arms (part # 17745 upper) and part# 17746SB lower). The top trailing arm goes into the original leaf spring perch (set the measurement between the knuckles at 16 1/4"). The original hole in the trailing arm perch will need to be opened up about 1/16". Use a die grinder to open up the hole. Use the 7/8x5 1/2" bolts and spacers to fasten the trailing arm into the spring perch. The spacer goes on the inside of the link. Use the 7/8" x 5" bolt to fasten the trailing arms into the air bag axle mounts. Set the lower trailing arm so there is 35 1/4" between the knuckles. Use the 7/8" x 8" bolts and spacers on the front trailing arm mount. Presetting the trailing arms at those distances should allow the final adjustment to be easier. If the arms get more than 1/4" off in length (top left compared to top right and bottom left compared to bottom right) they will bind when adjusting. Use the supplied flat washer on each side of the 7/8 bolt. Tighten these bolts to 275 lb/ft.



Passenger side



7. Remove the bump stops on the bottom of the frame. Now locate the upper air bag mounts (part# 70507DS and

70506PS), as well as the upper pan hard bar mount (part# 70504). The passenger side fastens to the frame with the 5/8x2 1/2" bolt and 1/2" bolts. You will install the upper pan hard bar mount at the same time. The driver's side fastens with three 1/2x1 1/2" bolts. You will have to drill the holes out for the 1/2" bolts. The hole in the bottom of the frame will locate the mounting placement. Once fastened, torque the 5/8" bolts to 150 ft/lbs and the 1/2" bolts to 85 ft/lbs. See next page for picture of pan hard bar mount installed.





8. Locate the 5748 air bags (part# 5748), 2 accumulator air tanks (part# 21002) and 3/4" air line. The air bags fasten in place with two 3/8x 1" bolts, flat washers and lock washers to the upper bag mount and a 5/8" nut and lock washer on the bottom bag stud. Insert the 90 degree air fitting and tighten into the top of the bag. Use Tef-

lon tape on the fitting threads. The accumulator tanks mount to the rear factory leaf spring shackle perch with the factory bolt. Make sure to mount to the large port faces forward. Insert the straight fitting in the tank. The rear tank port uses the 1/4" or 3/8" fitting, depending on what controls you are installing. Again use Teflon tape on the threads (unless it is supplied with it). Cut the 3/4" air line around 23" long and connect the tank to the air bag.



9. Locate the pan hard bar (part# 70505). Fasten it into the upper pan hard bar with the 5/8x4" bolt and fasten the other end into the lower bag mount/cross member with the 5/8x4 1/2" bolt. Once installed, torque the 5/8" bolts to 150 ft/lbs. (If your pan hard bar has heim ends, use a spacer on each side of the heim to center it up.

10. Locate the sway bar (part# 21003), sway bar bushings and the sway bar end links (part# 17744). The sway bar mounts to the bottom of the shock mounts on the bottom of the axle. Use the supplied grease to lube the blue bushings before you install them over the sway bar. Once that step is done, fasten with the "D" ring to the bottom of the axle with the m12x45 bolts. Torque these bolts to 45 ft/lbs.

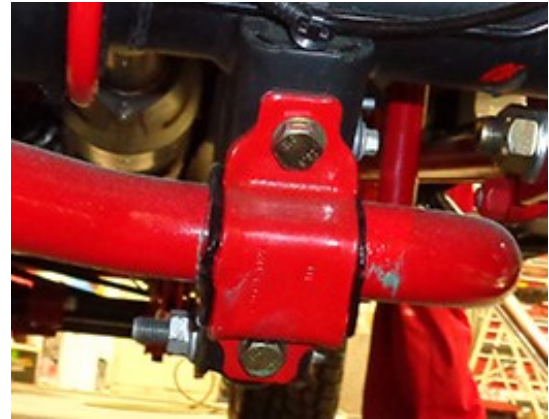

11. Once the sway bar is installed, install the sway bar end links. The sway bar end links attach to the sway bar with the 1/2x2 1/2" bolts. Make sure to use the large machined washer on the outside on the on the bolt head. The upper end of the sway bar attaches to the frame with the 1/2x2" bolt. Again make sure the machined washer is on the outside. To find out which hole to use in the frame, jack the frame of the truck up so the air bags would be 8" tall (the distance between the air bag mounting brackets). Now set the sway bar its level with the ground. With the end links straight up vertical, locate a hole to use. If no hole is there to drill out, drill your own hole. **NOTE: MAKE SURE TO LOOK INSIDE THE FRAME TO MAKE SURE THERE ARE NO FUEL OR BRAKE LINES AND WIRING!** Torque the 1/2" bolts to 85 ft/lbs.

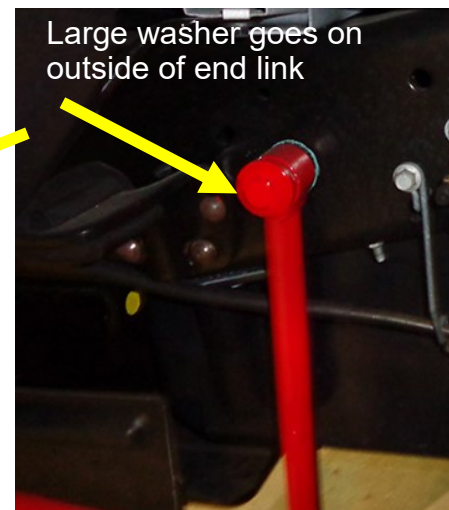
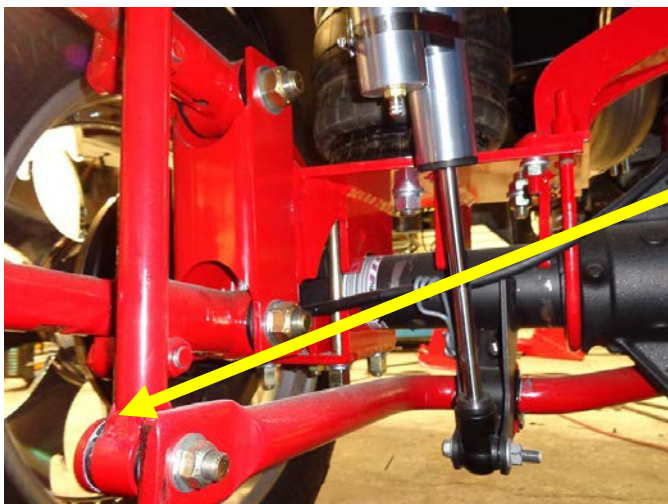

11. Locate the longer rear brake lines. Simply remove the factory lines and install the longer ones. Make sure you bleed the rear brakes before driving. Also check your brake fluid level after bleeding to make sure the truck does not run low. **THE OEM UPPER BRAKE LINE MOUNT WILL HAVE TO BE BENT UPWARDS SO THAT WHEN THE AIR IS DUMPED, THE PANHARD BAR MOUNT DOESN'T CUT THE BRAKE LINES! MAKE SURE TO CHECK THIS A COUPLE TIMES!**

13. If the truck is a long box, locate the carrier bearing drop (part# 11936) and kicker plate (part# 10579). You will use the 2" drop, not the 3" part. The kicker plate has a small thin piece of metal welded to it. Its used to kick the carrier bearing at an angle so the driveshaft going through it is close to the factory design. Install the top of the tube to the frame with the factory bolts and fasten the bottom of the carrier bearing/kicker plate and drop with the 3/8x1 1/2" bolts. Torque the factory bolts and 3/8" bolts to 35 ft/lbs



14. Locate the shocks. The part number will vary depend on what brand and what style was purchased. The upper end should slide over the oem stud. On the bottom, use either the factory bolts or the supplied 1/2" bolts to install, depending if the shocks have 1/2" or 14 mm spacers. You may have to use a washer or two as spacers on each side of the shock if they are narrower than your OEM shocks. Torque these bolts to 85 ft/lbs.

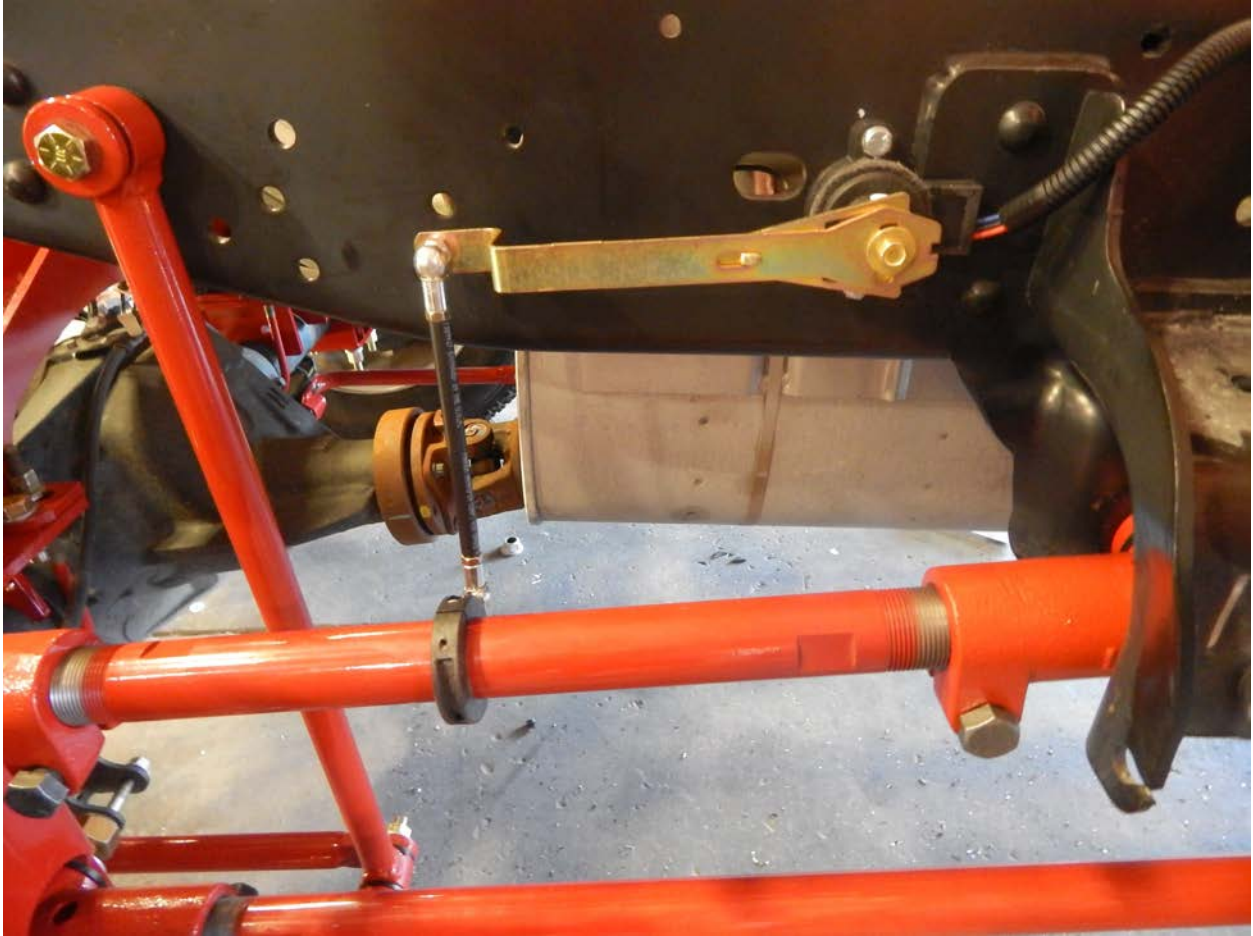

Hadley sensor

15. Locate your sensors/leveling valves. There are 3 different styles: mechanical Haldex valves, Hadley electronic sensors and Accuair electronic sensors. All valves/sensors mount to the frame and connect to the upper trailing arm. You can drill holes or drill and tap the frame for the 1/4x20" bolts. **NOTE: MAKE SURE YOU LOOK ON THE INSIDE OF THE FRAME FOR WIRES BEFORE DRILLING!** If the sensor linkage is too long for your application, just unthread the end, remove the black cover and cut the threaded rod to length. The sensors have a dead band when maxed out at the top and bottom. You will want at least a 1/8" gap between the arm and the plastic stop when all the way up or down. The sensor does not have to have this much range of travel to work. The mechanical Haldex unit has an eight second delay so it is slow reacting.

Hadley Box Mounting



The best place for the Hadley box and air tank is where the spare tire originally went. Use the supplied mounting tabs and weld them to the spare tire carrier. Make sure to use a battery protection device on the batteries or unhook the batteries before welding!



If a spare tire is going to be installed, relocate the drivers side accumulator tank, cut off the leaf spring shackle hanger and make a bracket to mount the box there. Make sure to measure out the box or reinstall the box before fully welding the mounting bracket to ensure its in the correct location.



AccuAir Mounting Tips

- Mount the ecu inside the truck either under the dash or under the back seat. This will extend the life of the ecu if its not exposed to road salts in the winter
- It works well to mount the manifold on the drivers side inside frame rail. Drill and tap the frame for the mounting bolts.
- A good spot for the Viair compressors are in between the box and the spare tire "well"
- Don't mount the Viair compressors upside down. It will shorten the life
- The sensors have a dead band the last 10% up and down, adjust your linkage accordingly.

Rear sensors mount straight up and down drill and tap for sensor or drill a hole and fasten with bolt

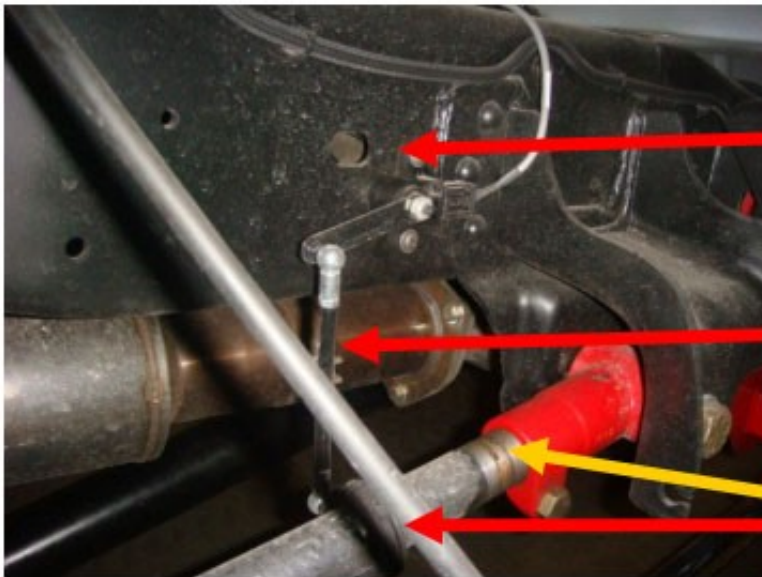

Top of sensor is 5/8" forward of the hole

6 1/4" linkage (center to center)

4" between knuckle and collar

AccuAir Sensors

Make sure to have 1/8" gap between sensor arm and plastic travel stop



Mechanical Valve Mounting Tips

- the height control valves have an 8 second delay
- before installing the height control valves rotate them 360 degrees each direction about 6 times
- mount the box where ever there is a spot. If the dryer hangs to low it can be removed and mounted somewhere else. The mounting bracket for the dryer can be cut off.
- the mechanical valves will mount the same way as the Hadley



Top Port - Exhaust
Middle Port - Air Spring
Bottom Port - Supply

**2011 F250-450 4-6" P/U
Shortbox / SRW**

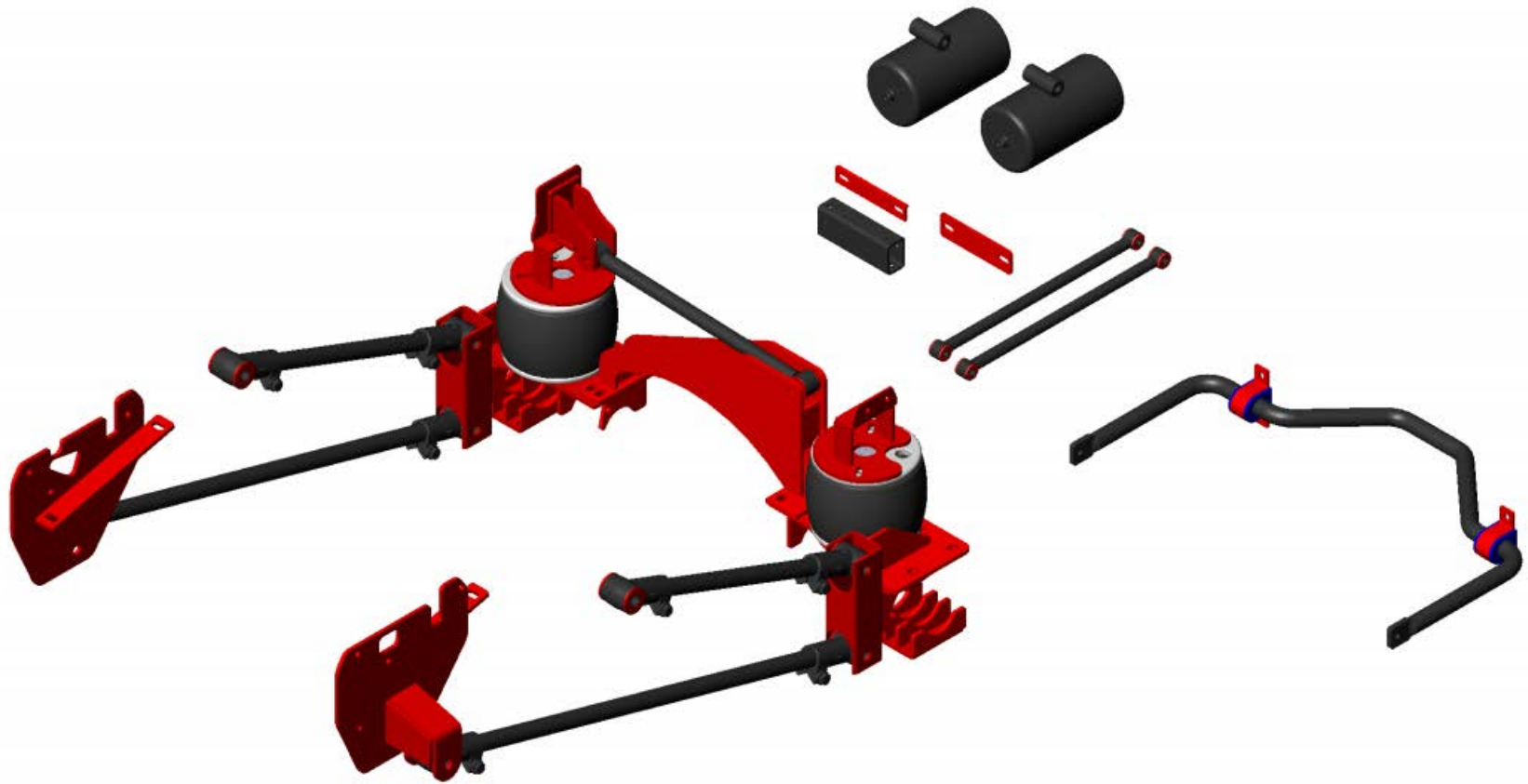

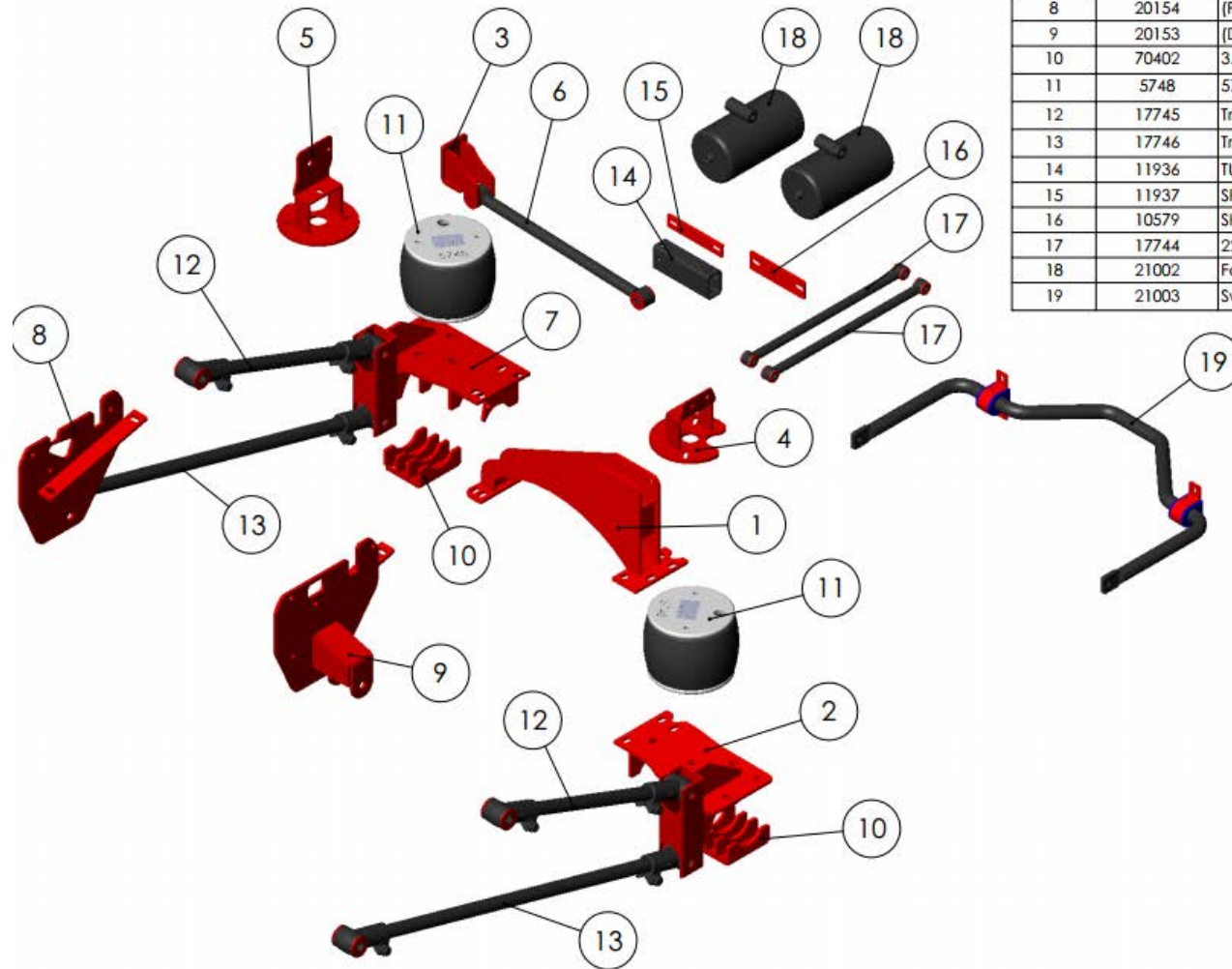

ITEM NO.	PART NUMBER	DESCRIPTION	QTY.
1	70540	(PHB) Crossmember	1
2	70403	(DS) Lower Bag Mount 3.5" Axle	1
3	70504	(PHB) Upper Frame Mount	1
4	70507	(DS) Upper Frame/Bag Mount	1
5	70506	(PS) Upper Bag Mount	1
6	70505	PHB 23 3/4"	1
7	70404	(PS) Lower Bag Mount 3.5" Axle	1
8	20154	(PS) Side Plate	1
9	20153	(DS) Side Plate	1
10	70402	3.5" Axle Clamp	2
11	5748	5748 Firestone Air Bag	2
12	17745	Trailing Arm Assembly w/ 22" Bar	2
13	17746	Trailing Arm Assembly w/ 41" Bar	2
14	11936	TUBE - CARRIER BEARING	1
15	11937	SPACER - BEARING KICKER	1
16	10579	SHIM - CARRIER BEARING - 1/4"- 3/8" - 1/2"	1
17	17744	22" End Link	2
18	21002	Ford Accumulator Tank	2
19	21003	Sway Bar Kit	1