

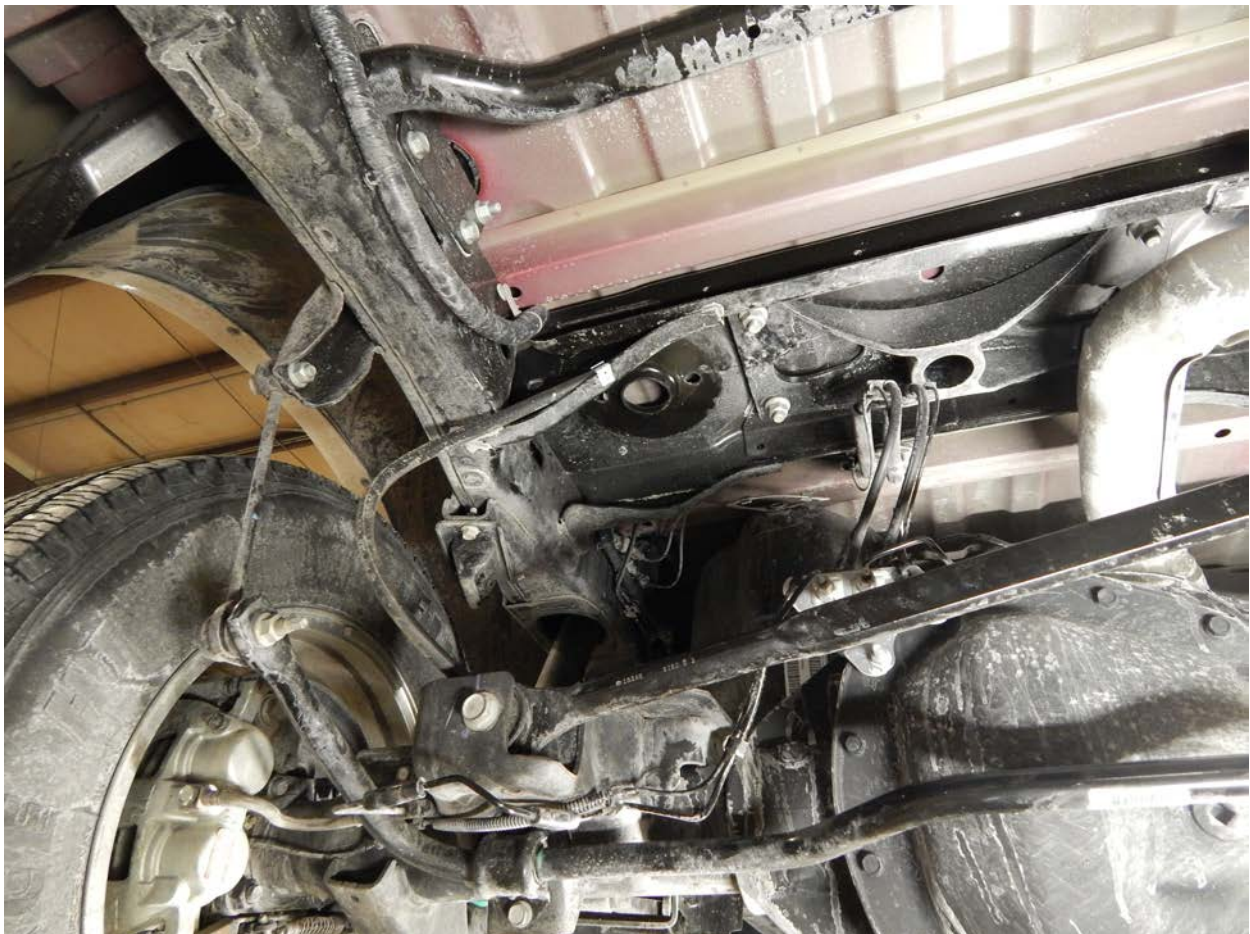

2014+ Ram 2500
Coil Replacement 8-**10" Rear**
Lift Installation Instructions



1. Before doing anything, place the truck on a level surface and use an angle finder to measure the pinion angle. Write the measurement here _____. Jack the truck up from the frame. You will also need to put a floor jack under the rear axle. Place jack stands under the frame while you work. Try and get the truck up a good 10-12" The rear coil springs need to be removed. To do this remove the bottom shock bolts and unhook the sway bar end links from the sway bar. Drop the axle down with the floor jack. NOTE: MAKE SURE TO WATCH THE BRAKE LINES AND NOT STRETCH AND DAMAMGE THEM. You will remove the rubber mounts that the springs set in also. Go ahead and remove the top shock nuts. The shocks will not be reused. You will also be removing the track bar as well as the 4 trailing arms, pan hard bar sway bar and sway bar end links. It works well to throw a strap over the front of the axle/driveshaft in order to keep the axle from rotating out of position.



2. Locate the upper air bag mounts (part# 19106DS and 19107PS). They fasten into the upper coil mounts with the 1/2" and 3/4" nut mounts (part# 19113 and 19114). Fasten the upper bag mounts in place and torque the 1/2" bolts to 85 ft/lbs and the 3/4" bolts to 125 ft/lbs.



3. Locate the brake line relocation bracket (part# 19046). Remove the 2 nuts off the mounting studs and slide the relocation bracket over the studs and fasten with the factory nuts. Torque to 20 ft/lbs. Next fasten the brake line bracket to the relocation bracket with the 1/4x1" bolts. Torque to 25 ft/lbs. Examine the brake lines along the axle. Make sure they are not rubbing on anything.

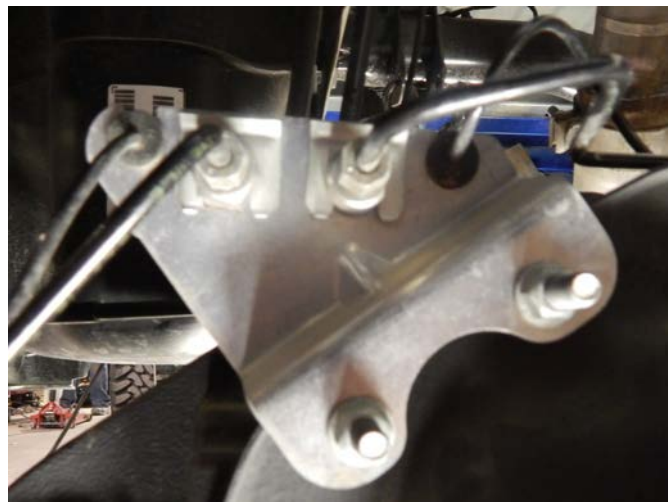

4. Locate the 4 trailing arms (part# 19051 upper and 19052 lower). Set the longer arms so there is 14 1/4" between the knuckles. These will be the bottom arms. Set the shorter arms at 11 11/16" between the knuckles (top arms). Insert the top bars first. Use the pictures on page 8 to set the bolt orientation. The factory bolts and nuts will be reused. While the trailing arms are removed, unhook the emergency brake line on the passenger side. Use the pictures below and page 6 to see how to reroute it. It will fasten to the lower trailing arm forward pinch bolt with the supplied clamp. Once the trailing arms are installed, torque the bolts to 200 ft/lbs.



By setting the trailing arms at these measurements the pinion angle and axle centering should be close.

Remove the e brake cable from this hole.



Remove the drivers side e brake cable from the metal loop that holds it in place. Unhook it from the connection on the side of the frame and push it back through the mounting brackets. It will now drop down and run up to the forward bracket. It will also tie into the lower forward trailing arm knuckle pinch bolt with the supplied clamp.

Remove drivers side e brake cable from this loop

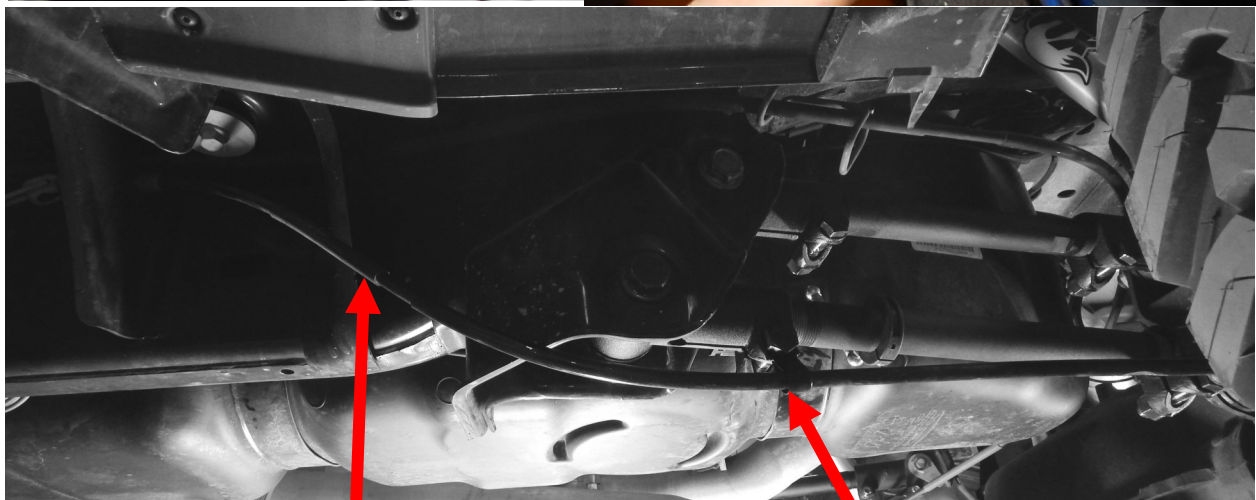

Brake cable now droops down below the rear mount that it originally was routed through

Clamp to the pinch bolt on the lower front knuckle



The lower trailing arms use the thicker walled bushings.

This tab needs to be bent so it will catch on the trailing arm mounting bracket.

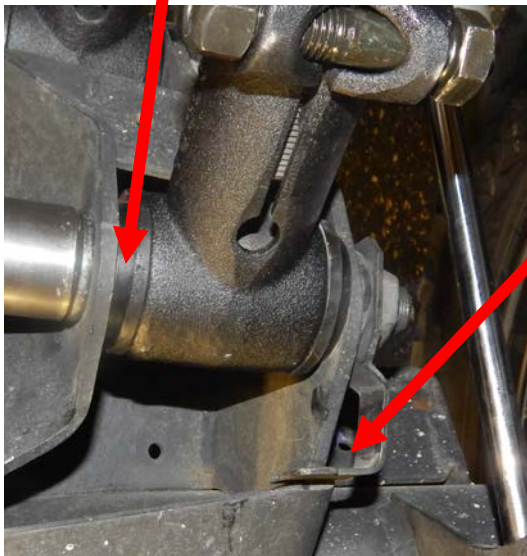

5. Locate the lower bag mounts (part# 19155 DS and 19163 PS). Beginning with the drivers side, place the bag mount on the axle. It fastens with the three 1/2x1 1/2" bolts (one hole gets drilled) and the factory pan hard bar mount. Once all the bolts are installed, torque the 1/2" bolts to 85 ft/lbs and the pan hard bar to 120 ft/lbs.

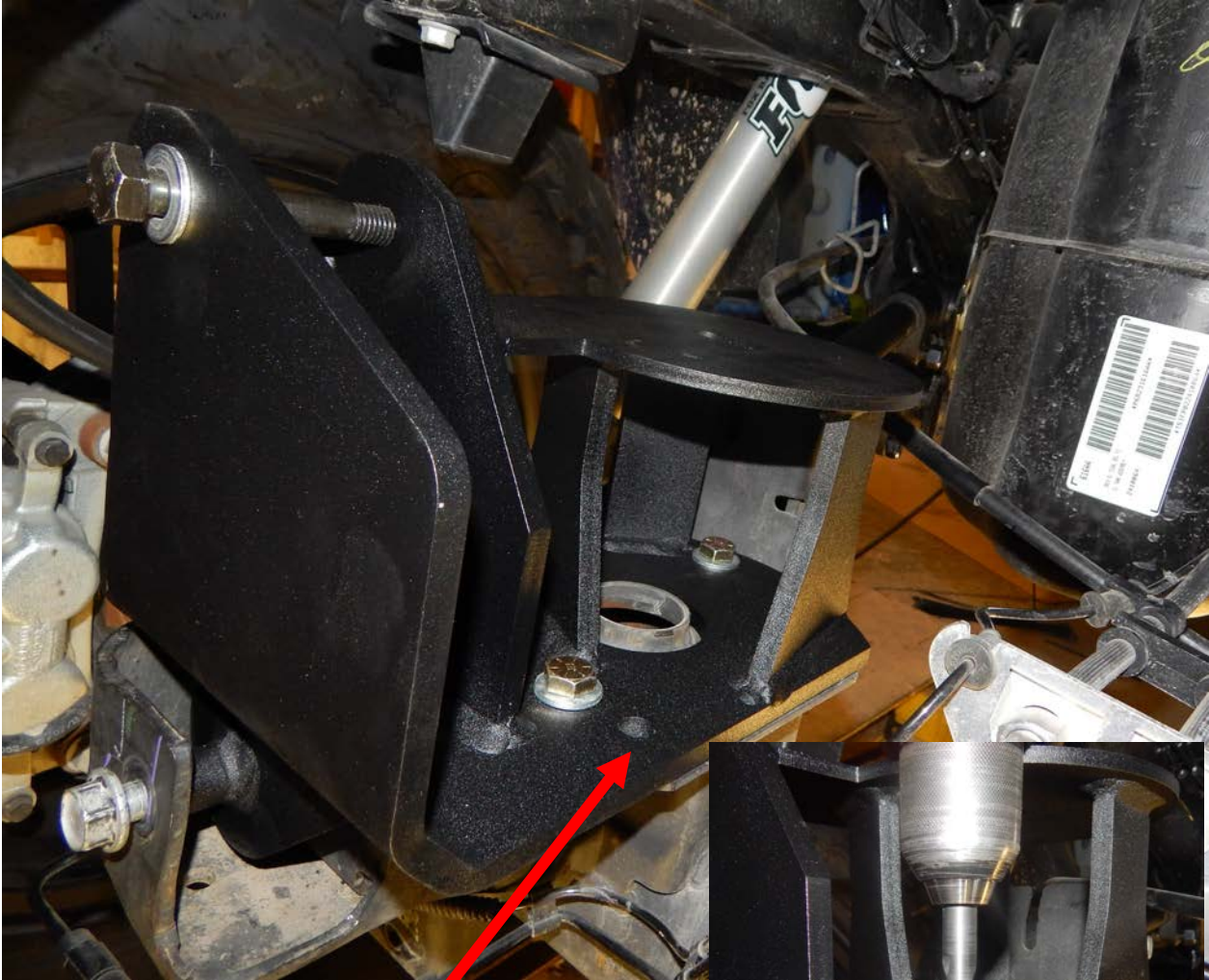

Drill this hole 17/32"

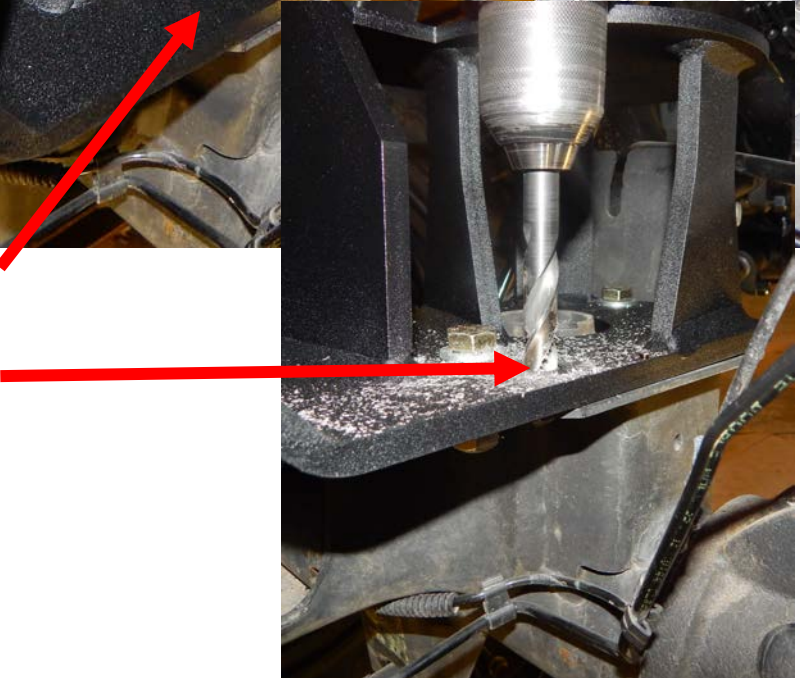

6. If your kit has the optional pan hard bar (part# 19167) locate it now. Set the heim ends so they are 35 13/16 center to center. Also locate the 4 spacers that go into each side of the heim ends. If not using the optional bar, locate the factory pan hard bar. It fastens into the lower air bag mount in the drivers side with the 9/16x4" bolt and in the factory location with the factory bolt on the passenger side. Torque these bolts to 135 ft/lbs.

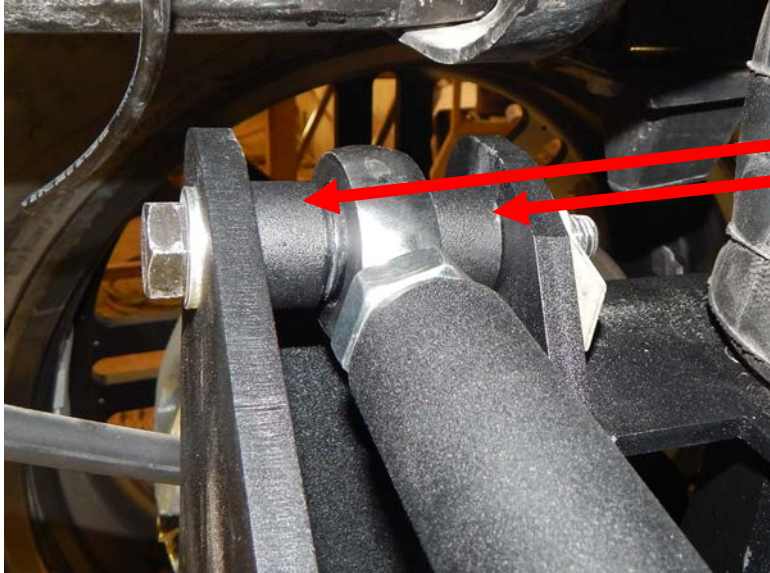

One spacer on each side of heim end



7. Locate the 2 holes in the top of the coil spring perch. Use the 17/32" drill bit to open up the holes. Now locate the passenger side lower bag mount and fasten to the axle with the two 1/2x1 1/2" bolts. Torque to 85 ft/lbs.

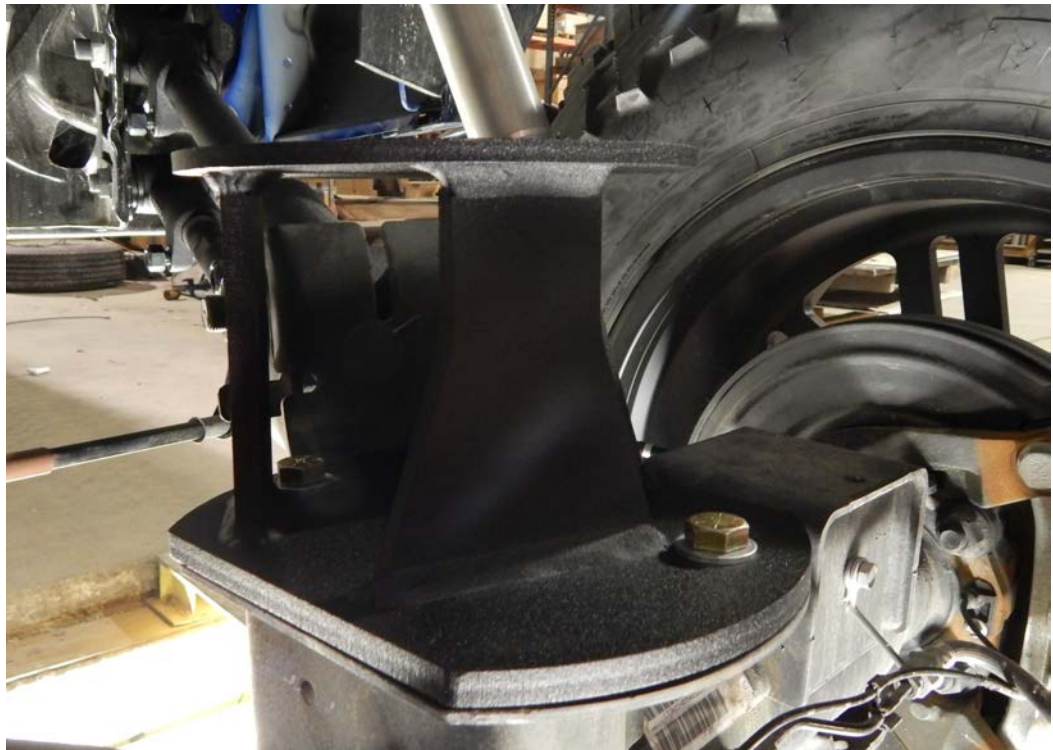
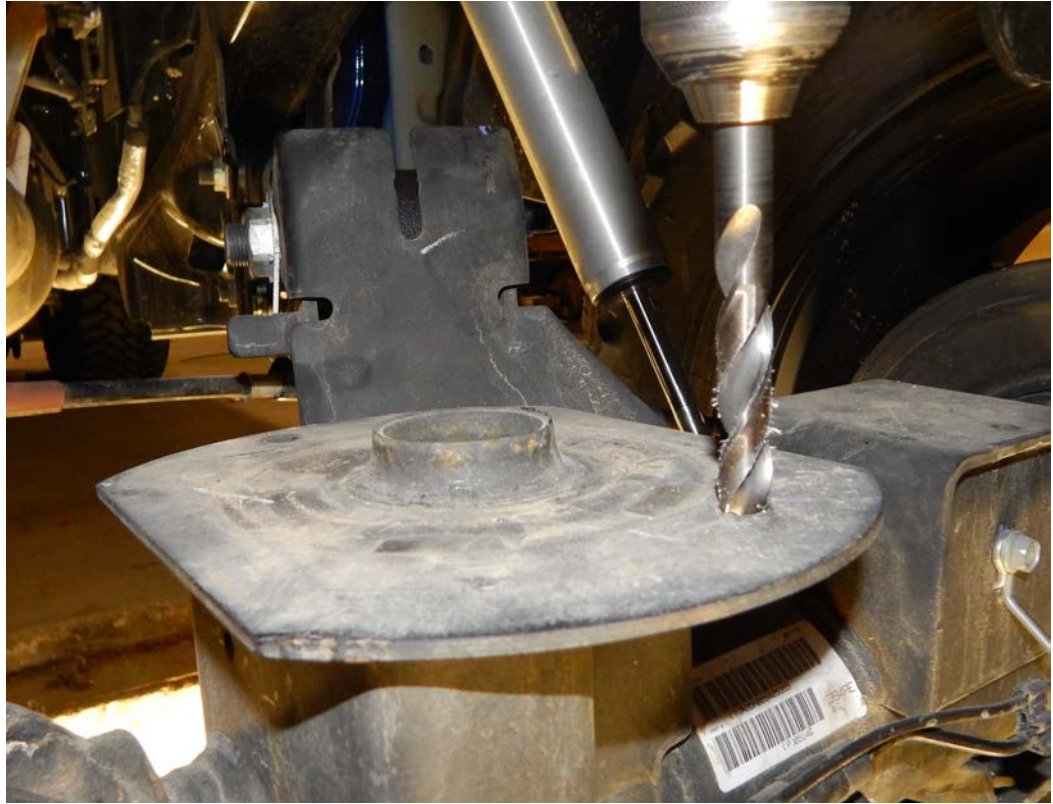

8. Locate the 8979 air bags. They fasten into the upper air bag mounts with the 1/2 and 3/4" nuts, flat washers and lock washers. The bottom of the bag fastens to the lower air bag mounts with the 1/2x5" bolts. Torque the bolts and nuts to 35 ft/lbs. Now locate the air fitting. Insert the fitting into the air bag and turn until it is finger tight. Now use a wrench to turn it once complete turn.

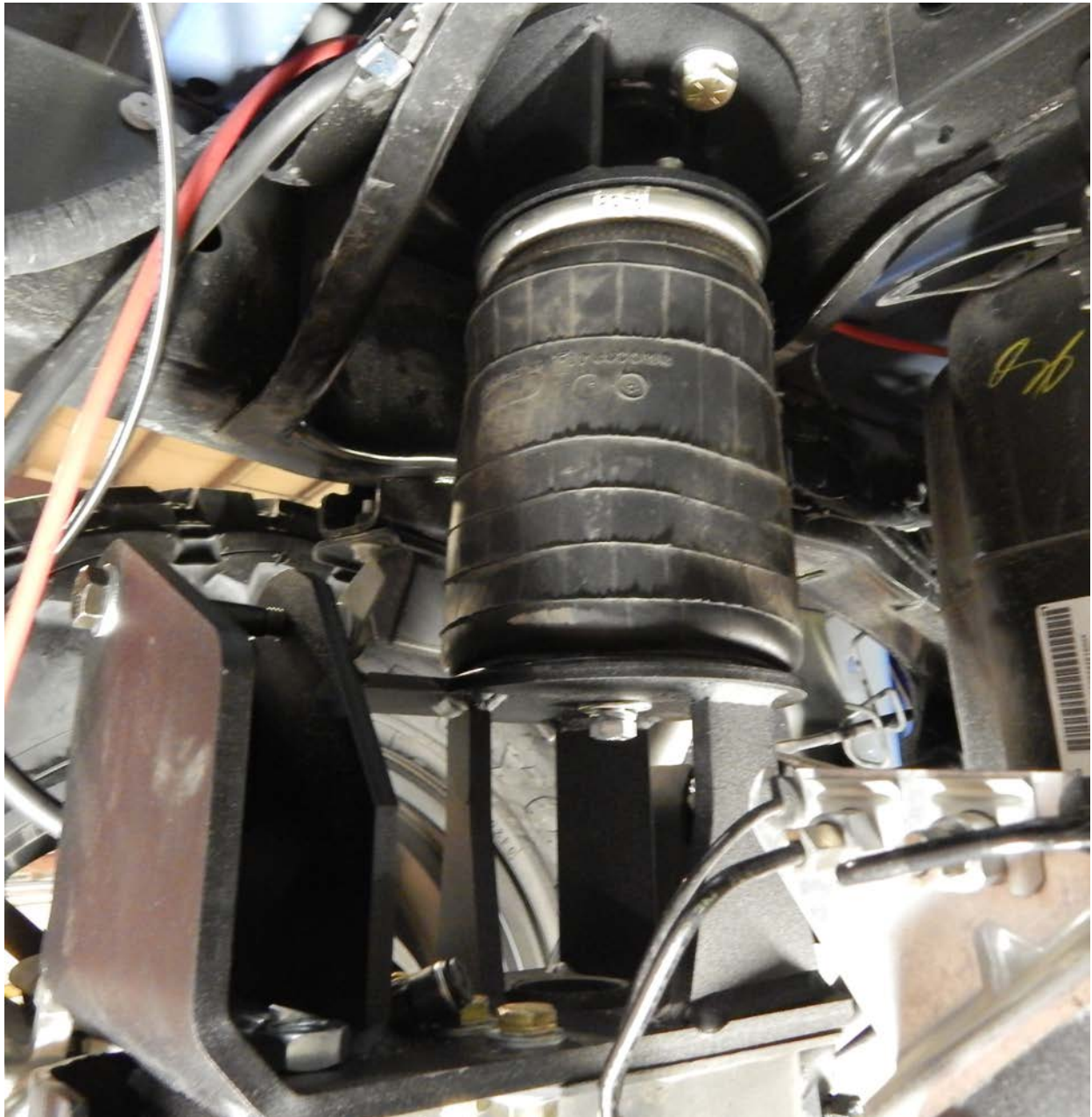

9. Now locate the shock relocation brackets (part# 19041). They fasten into the factory shock location with the 9/16x4" bolts and 3/8x1 1/4" bolts. Go ahead and install the shocks at this time. Use the factory bolts on the bottom to connect the shocks to the shock adaptors. You will torque the 9/16" bolts to 135 ft/lbs and the 3/8 top 45 ft/lbs.

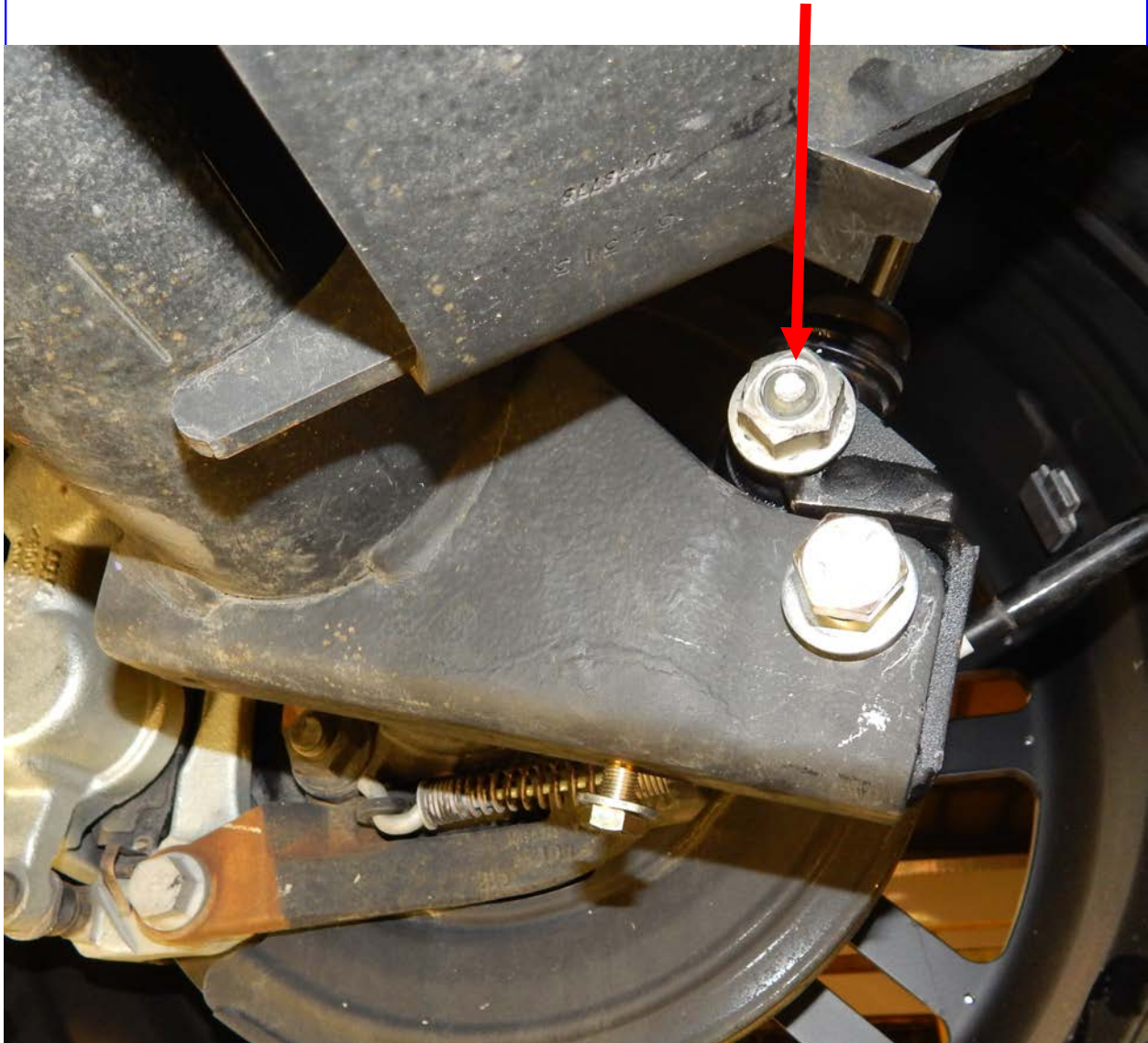

10. Locate the sway bar (part # 140KLD), the “D” rings, end links and upper end link adaptor mounts (part# 12345). The “D” ring holes will have to be opened up just a touch with a die grinder. (Your kit may already have them opened up at the factory). The holes need to be opened up towards the center in order to fit the factory holes. Use the provided grease to lube up the poly bushing before installing. Use plenty and then wipe the excess off once the install is complete. Failure to grease the poly bushing will result in a squeaking noise while driving. Fasten the sway bar to the axle with the factory sway bar bolts. Torque to 55 ft/lbs.

Open the holes up here to fit up to the holes in the factory sway bar mounts

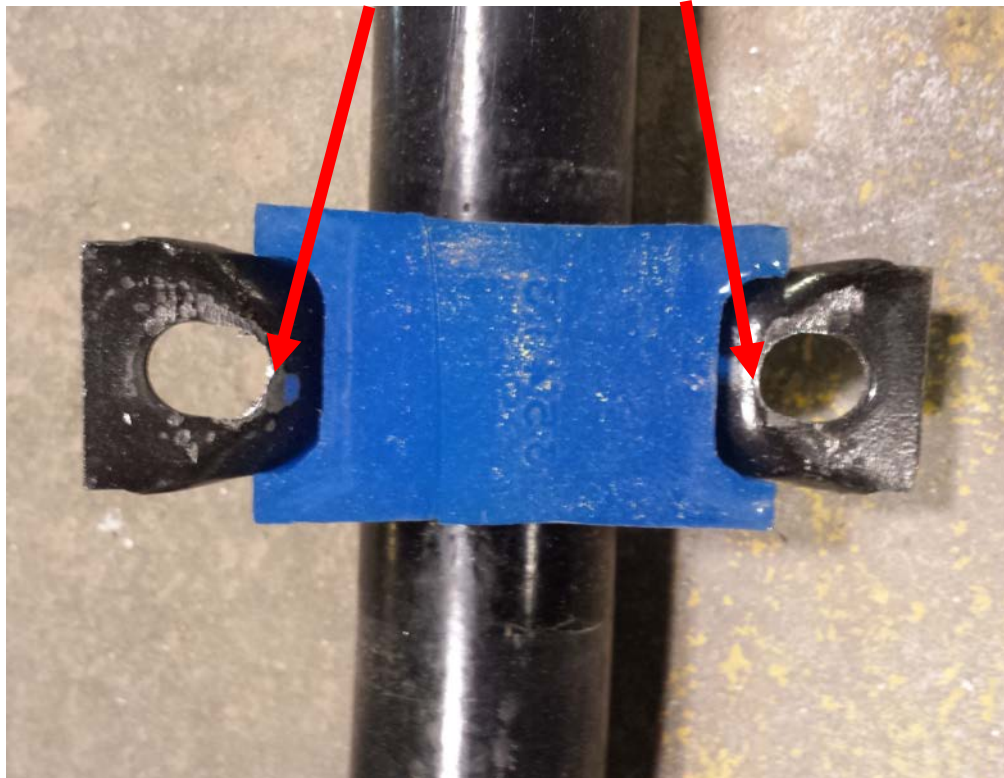

11. Locate the sway bar end links (part# 19164) and the upper end link mounts adaptors (part# 19161) The upper end link adaptors fasten to the factory end link mounts with the 1/2x3"bolts and the 3/8x 1 1/4" bolts. Fasten the bottom of the end link to the sway bar with the 1/2x3" bolt. Make sure to use the large flat washer on the outside of the end link (against the poly bushing). Torque the 1/2" bolt 85 ft/lbs and the 3/8" to 45 ft/lbs



go heavy on the grease and clean it up after the install is complete



Large washer on the outside of the bottom end link



12. Locate the 2 sensors and sensor mounting tabs. The tabs bolt to the hole in the trailing arm mounting brackets with the 1/2x1" bolt. Make sure to put the lock washer on the bolt head side when installing. This will keep the sensor mounting tab from rotating. The mounting tab should be straight out or lightly downward. Make sure the linkage doesn't hit on the pinch bolt when the air bags are deflated. The sensor linkage should be 3 1/2" center of ball to center of ball. Make sure the collar that goes on the lower trailing arm does not turn on. If it wont tighten up on the arm, remove it and use a file or grinder to take a little plastic off the mating surfaces. This will allow the 2 halves to clamp on the bar tighter.

This hole is already here

Linkage is 3 1/2"

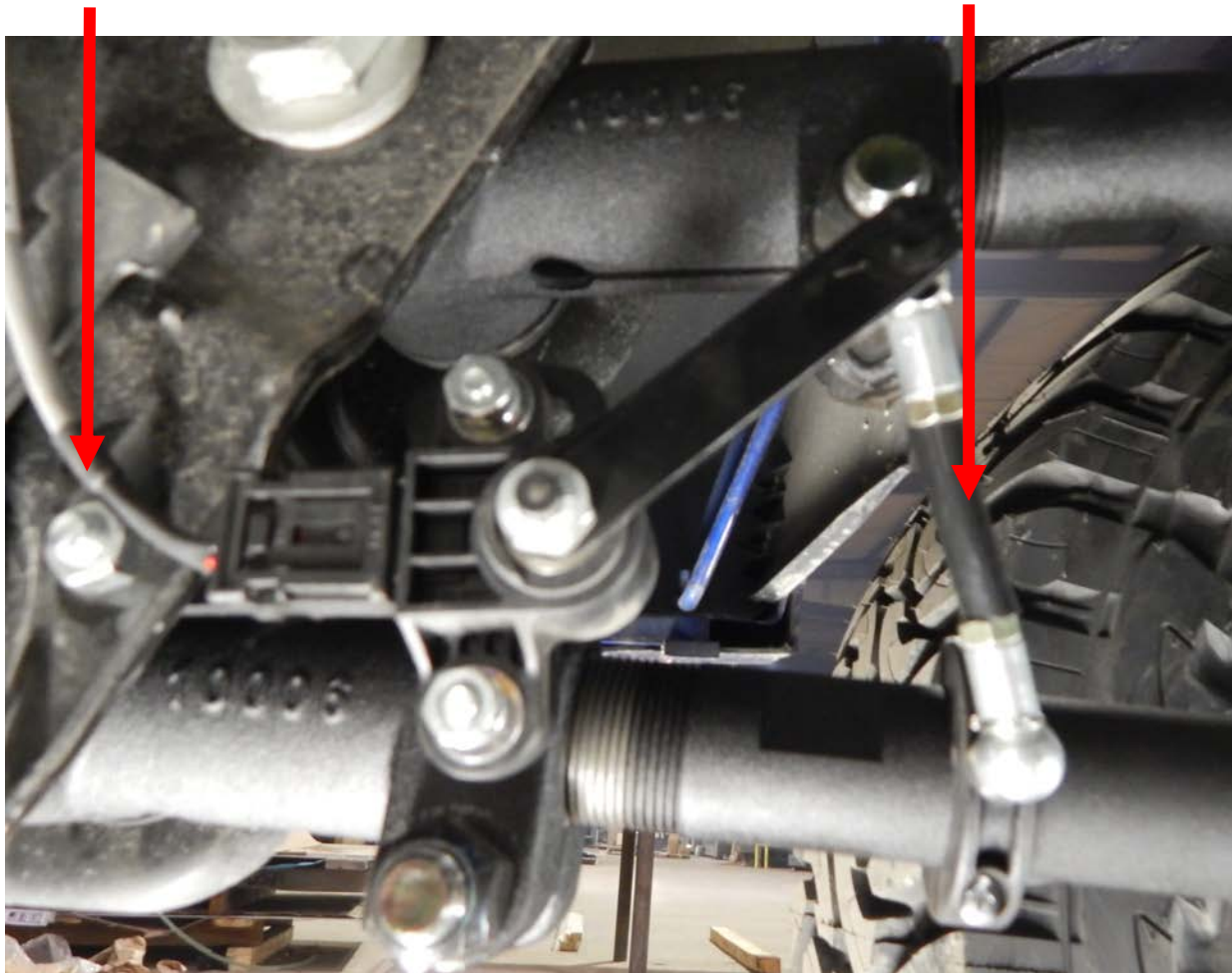

Place lock washer on bolt head side to keep the sensor bracket from rotating

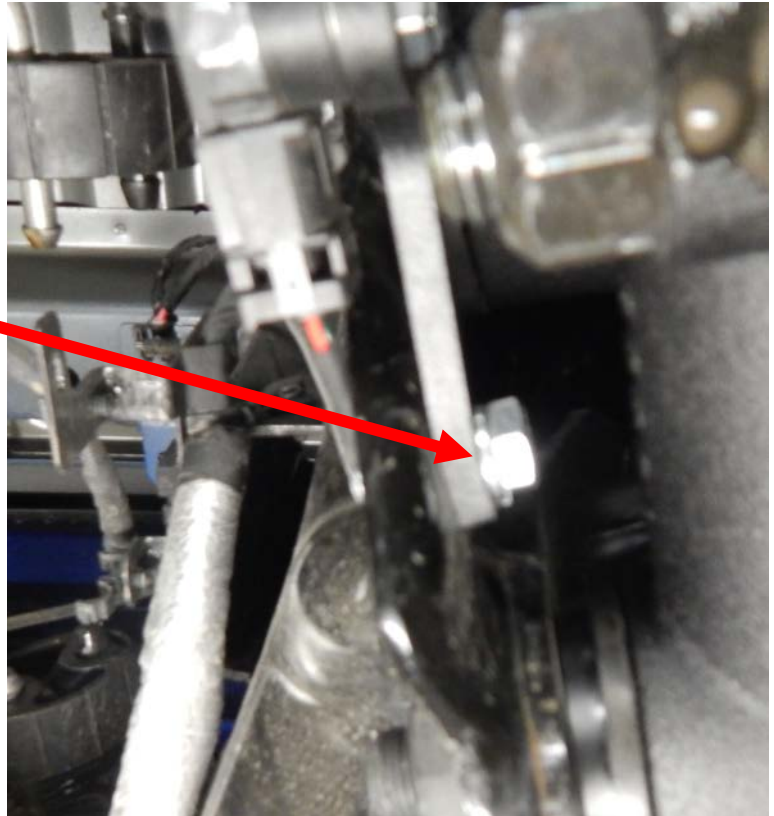

13. Locate the tanks for the air management system (part# 19049 PS and 19050 DS)
They will bolt to the side of the frame where the rear leaf spring perches are normally located on the truck. The holes will need to be drilled and tapped into the side of the frame. 3/8 bolts work the best.



14. Locate the air compressor mount it can be welded to bolted to the cross member on the frame. Its your call as to what kind of equipment your shop has. Once this installation the compressor system was crowded towards the drivers side in order to leave room for a larger aftermarket exhaust. The dryer was mounted to the drivers side frame rail.

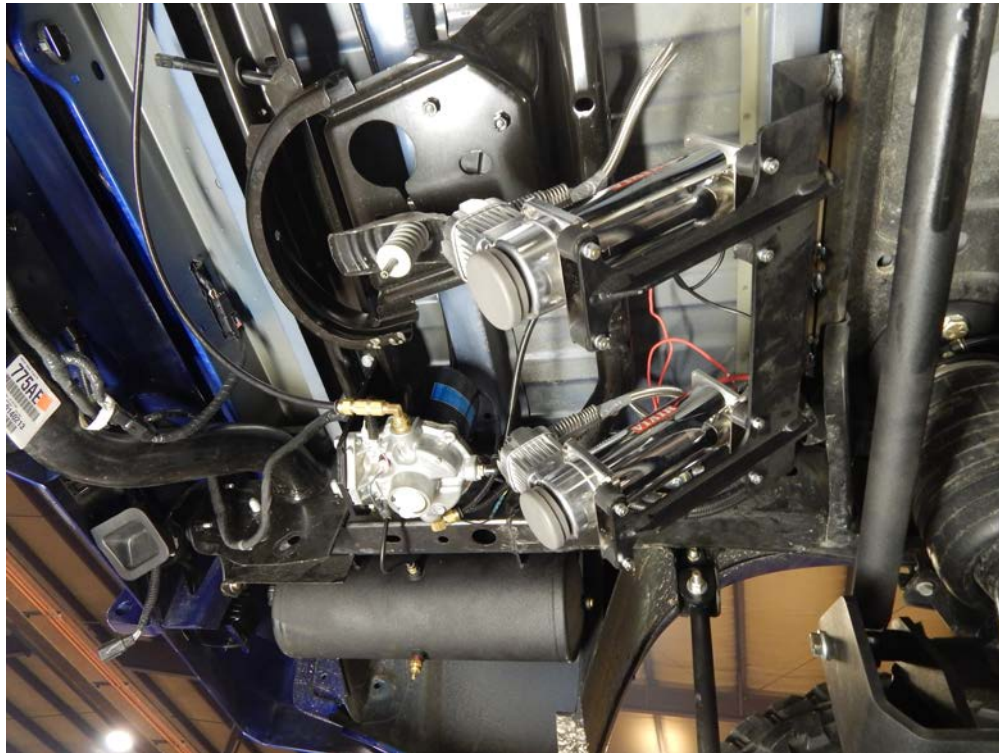

Drivers side front sensor installation. The frame is drilled and tapped for 1/4" bolt. This linkage is 7 3/8" The linkage arm just clears the body mount on the side of the frame

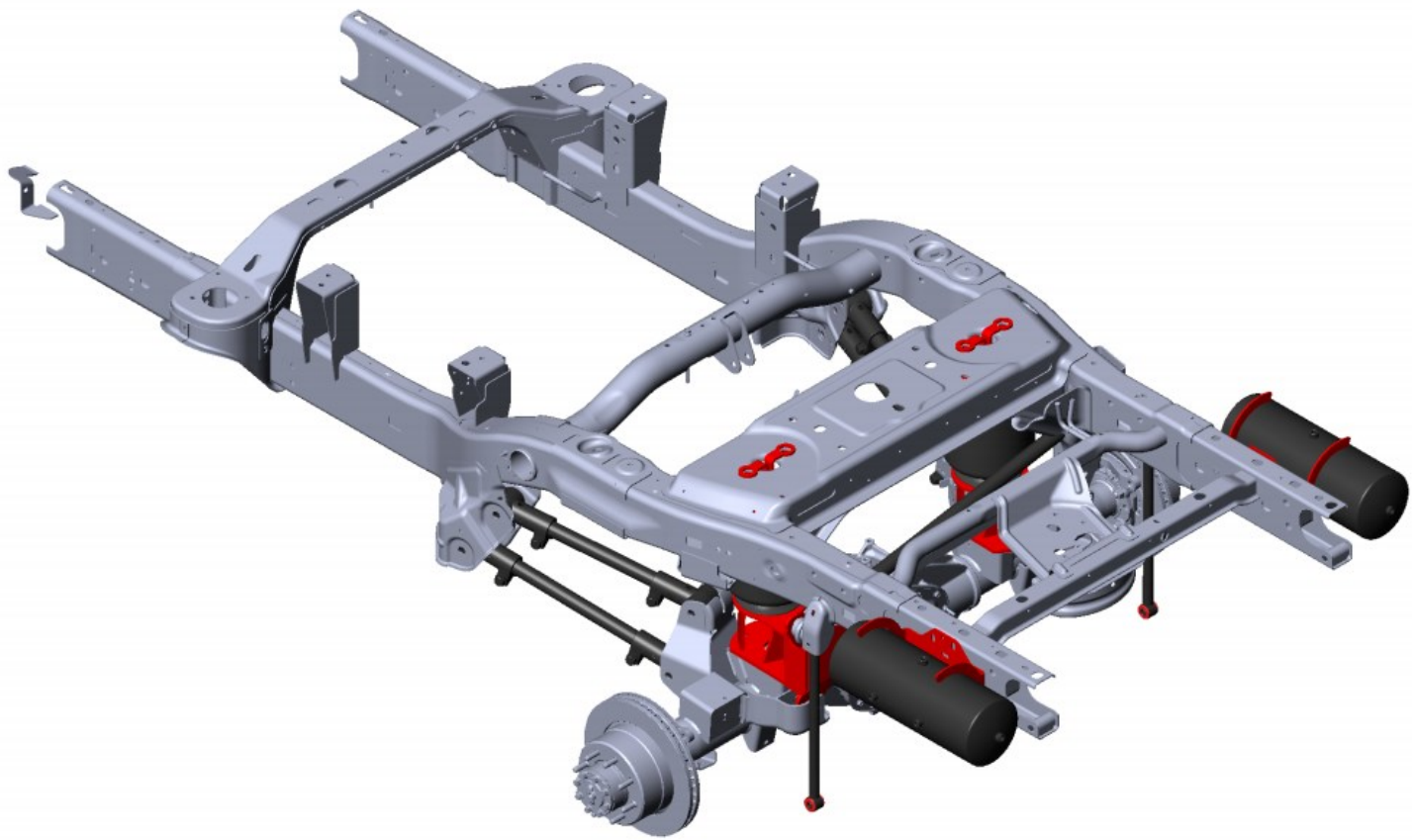

ITEM NO.	PART NUMBER	DESCRIPTION	Kit/QTY.
1	2014 2500 140WB PANHARD BAR		1
2	19106	(PS) Upper Bag Mount	1
3	19107	(DS) Upper Bag Mount	1
4	19155	(DS) Lower Bag/PHB Mount	1
5	19163	(PS) Lower Bag Mount	1
6	19041	Shock Relocation Bracket	2
7	19046	Brake Line Relocation Bracket	1
8	19113	3/4" Bolt Tool	2
9	19114	5/8" Bolt Tool	2
10	19161	End Link Mounting Ear w/ Bends	2
11	19164	18.5" End Link	2
12	19049	(PS) Air Tank Assembly	1
13	19051	18.5" Trailing Arm	2
14	19052	20" Trailing Arm	2
15	10023-1	8979 Firestone Air Bag	2
16	19167	Pan Hard Bar	1
17	19050	(DS) Air Tank Assembly	1

