

KARGO MASTER[®]

WE PUT EVERYTHING WITHIN REACH.

Installation Instructions

40651

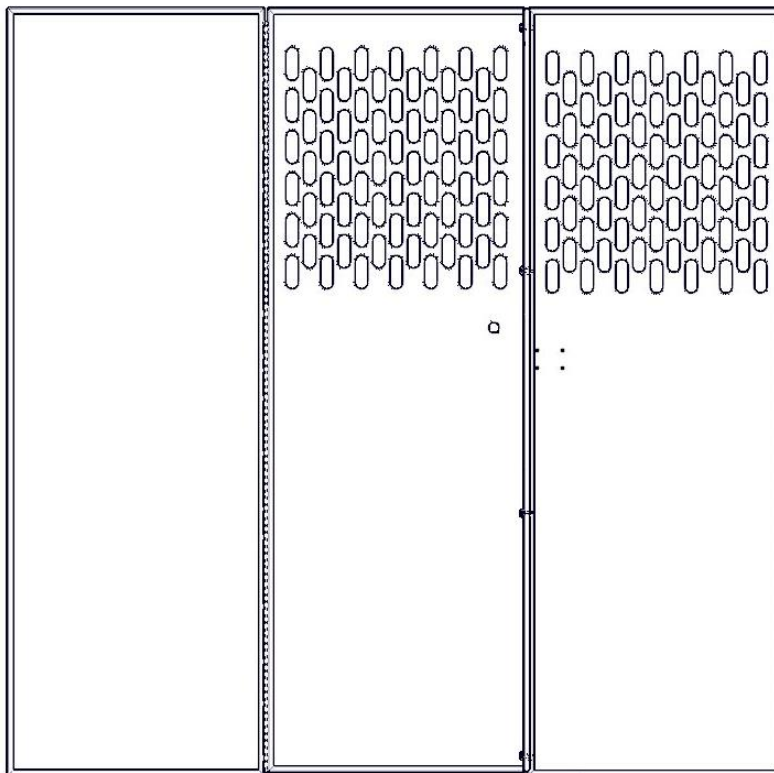

***PLEASE READ ALL INSTRUCTIONS AND WARNINGS PRIOR TO ASSEMBLING,
INSTALLING, AND USING THIS PRODUCT***

Warning



Always check for wires, fuel tanks and lines, brake lines and other important vehicle functionality items prior to drilling and installing all products.

Tools Needed

3/8" Wrench and Socket	7/16" Wrench and Socket
------------------------	-------------------------



Before You Begin

- Read all instructions

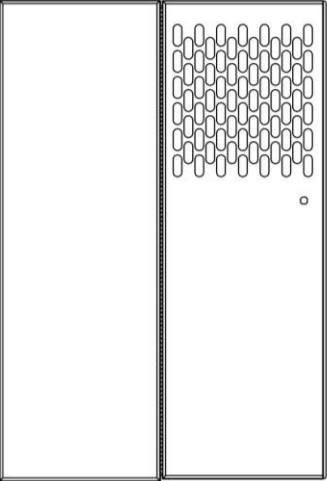
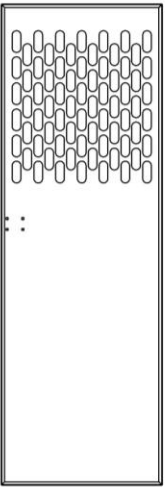
Parts

ITEM NO.	40651 PARTS	DESCRIPTION	QTY.
A		Partition Door Assy.	1
B		Partition Side Panel	1

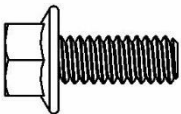
Hardware

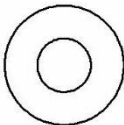
ITEM NO.	TO SCALE	PART NUMBER	DESCRIPTION	QTY.
1		92979A114	.25-20 x .625 Flange HH	4
2		93298A110	.25-20 Flanged Nyloc Nut	4
3		90126A029	.25 flat washer	8

Step 1 – Bolt Together

A.

- Place both pieces (A&B) flat on the ground or table. Be sure to have the flanges facing upward so you can access the bolt holes.

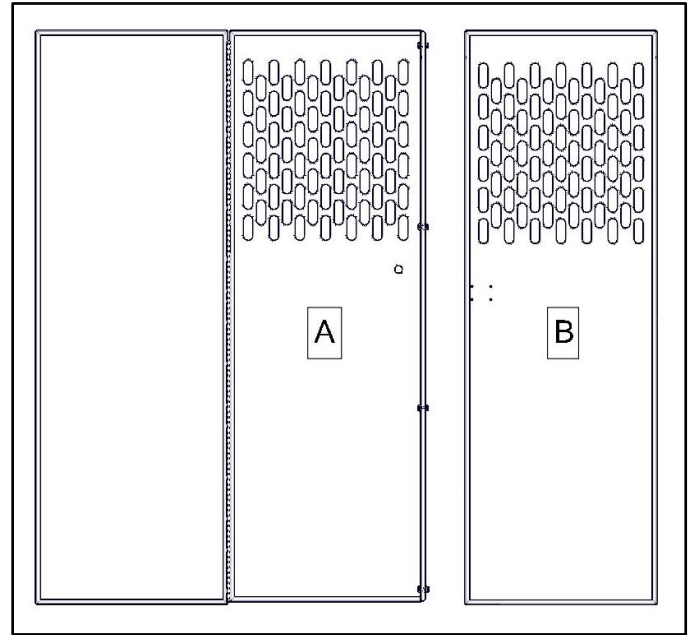

- Bolt together using a 1/4"-20 x .625" flanged hex bolt and a 1/4"-20 flanged nyloc nut.
- If installing the Door Kit (40260), Be sure to put two flat washers in between the two panels. This is used to get correct spacing.
- If no door kit is being used the washers (3) are not needed.

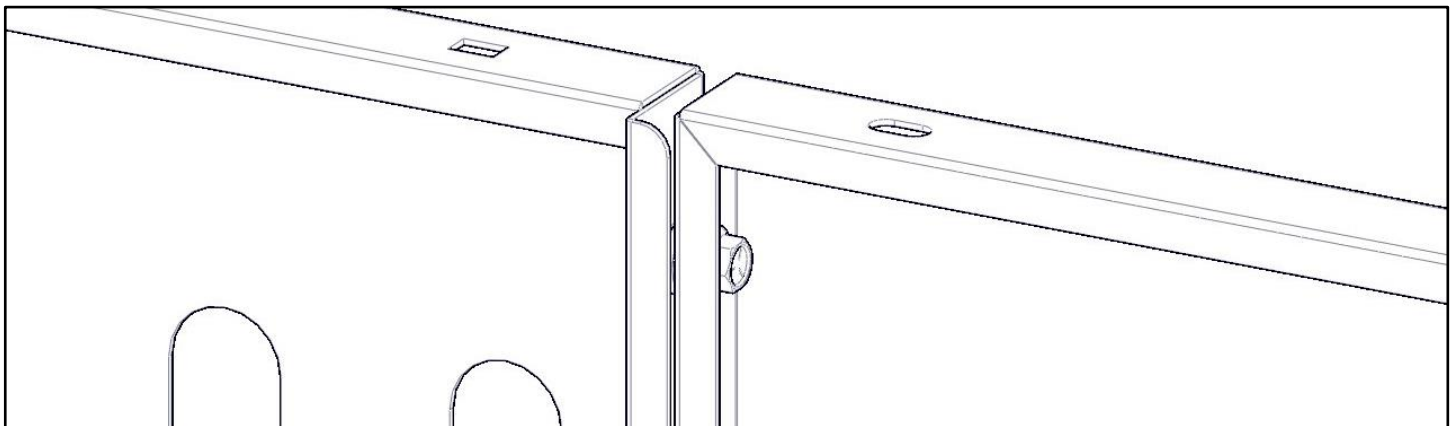
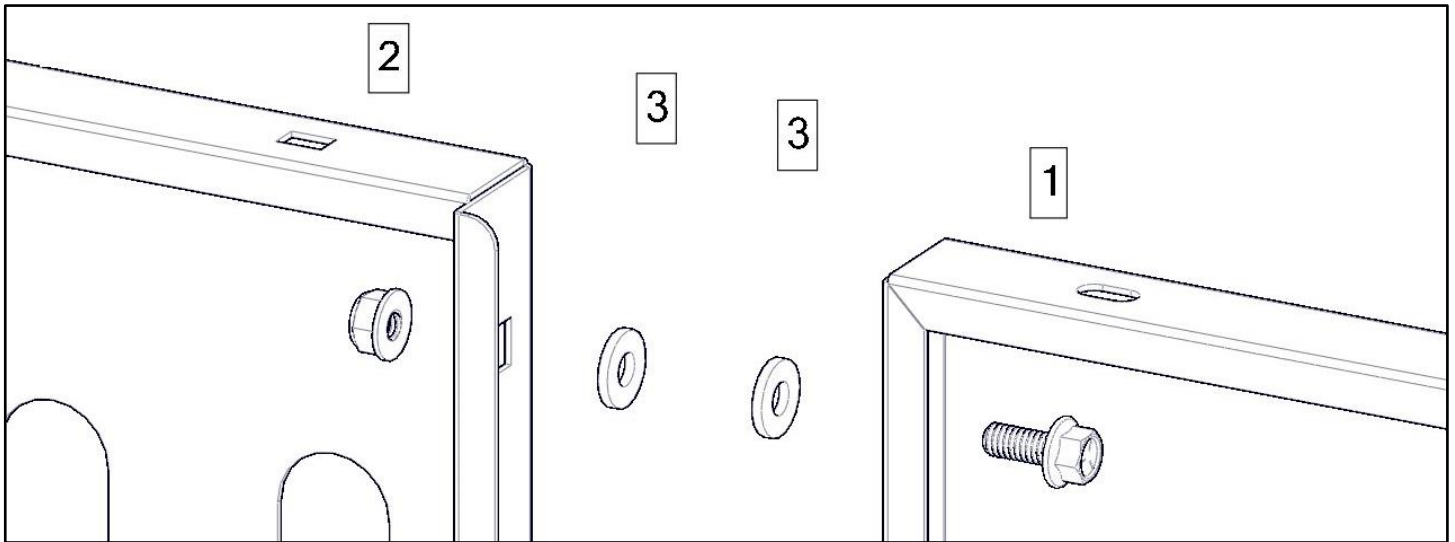

- Repeat 3 more times as shown. Be sure to insert the washers between the panels if needed.
- Some like to leave bolts snug tight to allow movement until partition is installed into vehicle.

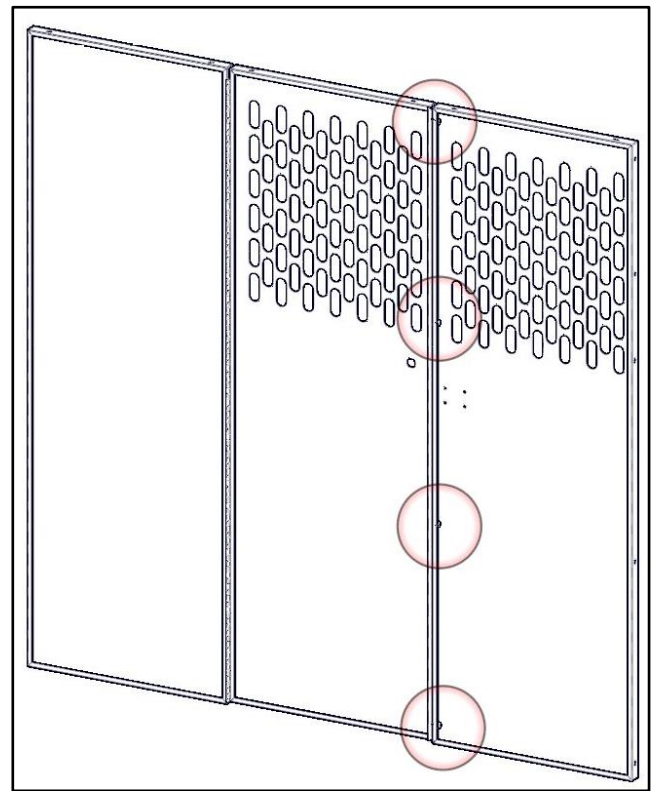

Follow instructions of desired wing kit to install into vehicle.