



#5700/#5700A/#5705/#5705A
Alpha MUTT® Series
Mobile **U**niversal **T**railer **T**ester

Operator's Manual



Tests Trailers with 7-Way Round Pin Type Connections
(Uses External 12/24 Volt Battery or Power Source)



LETTER FROM THE PRESIDENT OF IPA®

My name is Ian Vinci and I would like to thank you for your interest in our products. In today's world, we have all experienced the lack of service and consideration demonstrated by many companies after you buy their products. They say whatever they can to make the sale, and then it's like pulling teeth to get any service response out of them. I know this myself firsthand and because of this, I want to be sure that your experience with IPA® meets your expectations and that IPA® never disappoints you with our service or customer response.

Your satisfaction is more important to me than the sale itself. We will not be in business for long if we don't make you completely happy with our products and service. I want IPA® to be different and be known for its quality and service.

With that said, please take a look at our product line. You will see innovative first time products that were created to help you do your job faster and better than before.

I would also like to invite you to critique our products. If you can think of a better way to make them or changes that will make them work better, please contact me directly and I will be sure to look into it. If you have an innovation and would like some feedback, give me a call.

From all of us at IPA®, we thank you for taking the time to review our product line and wish you and your family the very best of everything.

TABLE OF CONTENTS

PART 1: IMPORTANT SAFETY INSTRUCTIONS	4
PART 2: WHAT'S INCLUDED	7
PART 3: CONTROLS AND PANELS	8
3.1 Left, Right and Back Panels	8
3.2 Electrical Control Panel	9
3.3 Air Brake Control Panel	10
PART 4: SET-UP	11
4.1 Choosing a Battery	11
4.2 Lifting the Unit	11
PART 5: PRETESTING CHECKLIST	12
5.1 Cable Testing Procedure	12
PART 6: GENERAL CONTROLS AND OPERATIONS	13
6.1 Initial Startup and Shutdown	13
6.2 Auto Shutdown Feature	13
6.3 Using the 3-Button Remote Control	14
6.4 Using the 12-Button Remote Control	14
6.5 Using the Tablet	15
PART 7: ELECTRICAL/LIGHTING TESTING	17
7.1 Selecting a Circuit	17
Auto-Cycle Mode	17
7.2 Ground Integrity Test	18
Establishing a Chassis Ground	18
7.3 Fault Indication	19
Open Circuit	19
Crossed Circuits	19
Short/Overloaded Circuit	20
7.4 Activating Hazard Lights	21
7.5 All Circuits On (Override) Mode	22
PART 8: AIR BRAKE TESTING	23
8.1 Testing Set-Up	23
8.2 Setting Desired Working Pressure	24
8.3 Leak Down Testing	24
8.4 Actuating Air Brakes	25
8.5 Emergency Air Exhaust	26
PART 9: ABS BLINK CODE DIAGNOSTICS	27
9.1 Meritor/WABCO Blink Codes	28
9.2 Haldex Blink Codes	29
9.3 Bendix® Blink Codes	34
PART 10: TYPICAL TRAILER WIRING	37
PART 11: MAINTENANCE AND STORAGE	38
PART 12: ADDITIONAL TESTING PROCEDURES	38
PART 13: OPTIONAL ACCESSORIES AND RELATED PRODUCTS	39

PART 1: IMPORTANT SAFETY INSTRUCTIONS

IT IS IMPORTANT TO READ, UNDERSTAND AND FOLLOW ALL SAFETY MESSAGES AND INSTRUCTIONS PRINTED IN THIS MANUAL AND ON THE EQUIPMENT BEFORE OPERATING. IF SAFETY INFORMATION IS NOT HEHEDED, SERIOUS INJURY OR DEATH TO THE OPERATOR OR BYSTANDERS MAY OCCUR.

DANGER

Indicates a hazardous situation, if not avoided, will result in death or serious injury. The possible hazards are shown in the adjoining symbols or explained in the text.

WARNING

Indicates a hazardous situation, if not avoided, could result in death or serious injury. The possible hazards are shown in the adjoining symbols or explained in the text.

CAUTION

Indicates a hazardous situation, if not avoided, may result in minor or major injury. The possible hazards are shown in the adjoining symbols or explained in the text.

THE FOLLOWING SAFETY ALERT SYMBOLS ARE USED IN THIS MANUAL.



SYMBOL 1: Potential burn hazard. Sparks from electrical shorts can ignite flammable liquids such as fuel or oil. Heat from electrical overloads can cause fire hazards.

SYMBOL 2: Potential electrical hazard. Batteries have enough electrical energy potential to ignite flammable liquids such as fuel or oil. Wire overloads can cause electrical failures. Shock hazard exists.

SYMBOL 3: Potential explosive air hazard. Pneumatic pressures used with this equipment can cause explosive failures on damaged equipment.

SYMBOL 4: Potential eye hazard. Wear OSHA approved safety glasses. Battery acid and high air pressures create hazardous situations for eyes.

SYMBOL 5: Potential chemical burn hazard. Wear protective gloves. Battery acid is corrosive and can cause skin damage.

SYMBOL 6: Potential electrical hazard. Electrical energy can cause heat and burn hazards.

SYMBOL 7: Potential fire hazard. Use caution with flammable liquids such as fuel and oil. Electrical shorts can ignite flammable liquids and wiring.

SYMBOL 8: Important information is stated.

BATTERY GASES, TESTER PREPARATION AND TESTER/CHARGER LOCATION

RISK OF EXPLOSION

- Gases produced by a battery are highly explosive.
- Wear safety goggles and protective clothing, both users and bystanders.
- Use in an area having at least four air changes per hour.
- Read, understand and follow all instructions for charger, battery, vehicle and any equipment used near battery and charger.
- Do not smoke, strike a match, place metal tools on battery or cause a spark in the vicinity of the battery. When removing battery cables, remove the ground cable first.
- Clean terminals before charging battery. During cleaning, keep corrosive particles from eyes, nose and mouth. Use baking soda and water to neutralize acid and help eliminate airborne corrosion.
- Never allow clamps on charger cables to touch each other.
- Do not expose tester or charger to rain, snow or wet conditions.
- Do not allow battery gases or acid to contact MUTT® cabinet. Do not place charger directly above or below battery.
- Fill battery to level specified by battery manufacturer using distilled water.
- Do not remove cell caps while charging per manufacturer's instructions.
- Make sure tester cable clamps make tight connections.
- Battery explosion can cause injury.



BLUETOOTH® MODULE

This equipment has been tested and found to comply with the limits for a Class B digital device, pursuant to part 15 of the FCC Rules. These limits are designed to provide reasonable protection against harmful interference in a residential installation. This equipment generates, uses and can radiate radio frequency energy, and if not installed and used in accordance with the instructions, may cause harmful interference to radio communications. However, there is no guarantee that interference will not occur in a particular installation. If this equipment does cause harmful interference to radio or television reception, which can be determined by turning the equipment off and on, the user is encouraged to try to correct the interference by one or more of the following measures:

- Reorient or relocate the receiving antenna.
- Increase the separation between the equipment and receiver.
- Connect the equipment into an outlet on a circuit different from that to which the receiver is connected.
- Consult the dealer or an experienced radio/TV technician for help.

GENERAL CHARGER USE

RISK OF ELECTRIC SHOCK AND FIRE

- Before connecting charger cable to unit, make sure controls are set to OFF.
- Do not remove or bypass the grounding pin.
- Do not operate charger with damaged cord or plug. Replace cord or plug immediately if damage occurs.
- Position power cord and charger cables away from the hood, doors and hot or moving engine parts where they could be damaged.
- Unplug power cord by grasping and pulling on the plug, rather than the cord when disconnecting charger from outlet.
- Charger power cord uses an equipment-grounding conductor and a grounding plug. Plug only into a 120V AC outlet that is correctly installed and grounded in accordance with all ordinances and local codes.
- Unplug power cord from outlet before cleaning or maintaining tester and charger. Turning off controls does not reduce the risk of electric shock.
- Do not operate charger after a sharp impact, drop or any other damage. Do not disassemble charger.
- Use only recommended attachments.
- Do not charge a frozen battery.
- Do not overcharge a battery.
- Use charger only on lead-acid automotive batteries. Do not use charger to charge dry-cell batteries.
- Electric shock or fire can cause injury.



RISK OF ENTANGLEMENT

- Keep yourself, clothing and battery charger leads clear of moving parts such as fan blades, pulleys, hood and doors.
- Moving parts can cause injury.

RISK OF BURNS

- Batteries can produce a short circuit current that is high enough to weld jewelry such as rings, bracelets and watches. You must remove them before working near batteries.
- Short circuits can cause injury.

PART 2: WHAT'S INCLUDED

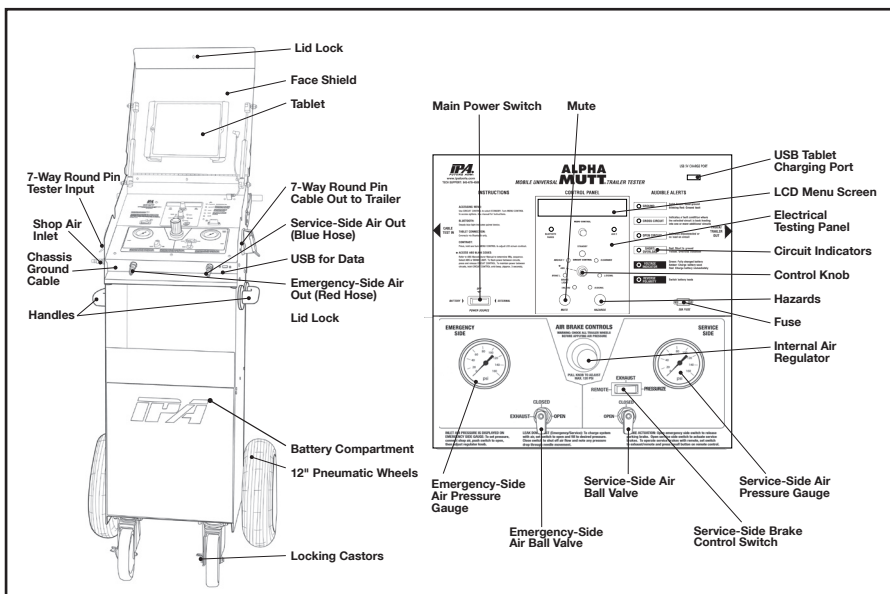

INCLUDED PARTS AND ACCESSORIES

12-BUTTON REMOTE CONTROL
#MUT-RM12



3-BUTTON REMOTE CONTROL
#MUT-RM3-9005A/8



TABLET
#5700-TAB



TABLET CHARGER
#5700-TABCH



12' 7-WAY CABLE
#7900K-1-12AS



12' RED GLADHAND
#7900AP-12RED-FX



12' BLUE GLADHAND
#7900AP-12BLU-FX



RAIN COVER
#CVR-0002



BATTERY JUMPER CABLE
#5700-BLKJMPR-AS



BATTERY JUMPER CABLE
#5700-REDJMPR-AS



POWER CORD
#7900K-80ACORD



MICRO USB
#CBL-9INUSBMIC



PART 3: CONTROLS AND PANELS

An overview of the MUTT®'s controls, inputs, outputs and their functions.

3.1 LEFT, RIGHT AND BACK PANELS

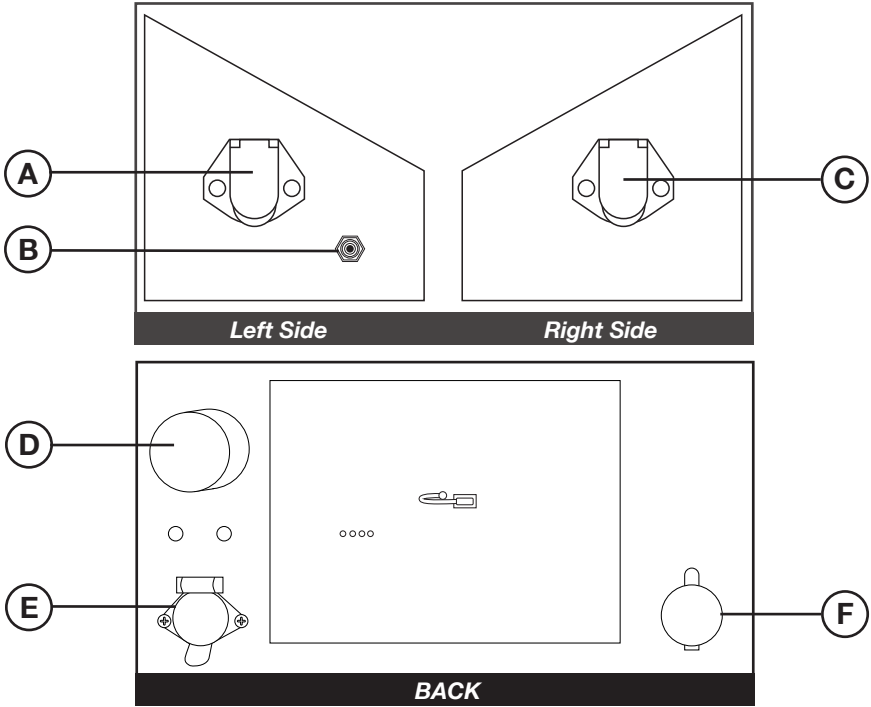

A. 7-WAY ROUND PIN CABLE TEST INPUT

For testing the integrity of a 7-way round pin trailer cable. Can also be used to verify that the MUTT® is operating correctly.

B. SHOP AIR INPUT

A bulk-head air input with external stone filter that is used to connect an air compressor to the MUTT® for testing air brakes on a trailer.

C. 7-WAY ROUND PIN CABLE OUT TO TRAILER

For connecting 7-way round pin trailer to the MUTT® to test electrical circuits.

D. BLUETOOTH® CONNECTIVITY RECEPTICLE

E. 20 AMP INDEPENDENT POWER INPUT

For connecting external 12V DC 20 amp max. power supply. (Power supply is an optional accessory, not for battery charging.)

F. 12V DC BATTERY TRICKLE CHARGE INPUT (CIGARETTE SOCKET)

For connecting a trickle charger to the MUTT®'s internal battery (battery not included).

3.2 ELECTRICAL CONTROL PANEL

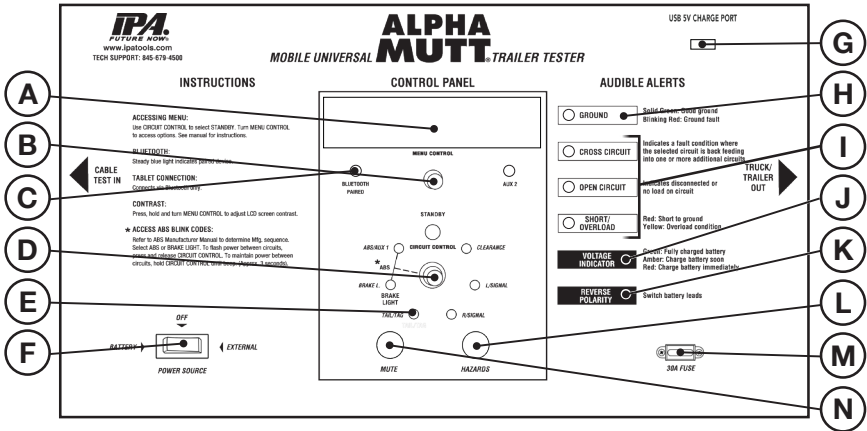

A. LCD MENU SCREEN

B. LCD MENU CONTROL KNOB

Knob activates all menu options and modes.

C. BLUETOOTH® PAIRED INDICATOR

Steady blue light indicates paired device.

D. CONTROL KNOB

Knob activates all electrical test modes and circuits to be diagnosed.

E. CIRCUIT INDICATORS

The small green LEDs illuminate or blink in testing phase.

F. POWER SOURCE SWITCH

Select between Internal Battery, External Power or Power Off.

Center: OFF (battery charge in this position only)

Left: Installed Battery ON

Right: External Power ON (power supply is an optional accessory)

G. TABLET CHARGE PORT

For charging tablet. Not a data port.

H. GROUND INTEGRITY

Solid green LED indicates good ground. Blinking red LED indicates a bad/poor ground. Ground integrity is automatically verified when power is turned on.

I. TROUBLE WARNING INDICATORS

Flashing red LEDs indicate problems that may exist in a selected circuit. This includes the Overload Indicator, Open Circuit Indicator and Reversed (Battery) Polarity Indicator.

J. VOLTAGE INDICATOR

Green LCD indicates fully charged battery. Amber LED indicates battery will need charge soon. Red LED indicates battery needs charge immediately.

K. REVERSE POLARITY INDICATOR

Indicates when battery leads need to be switch due to reversed polarity.

L. HAZARD BUTTON

Activates the four-way flashers on trailer.

M. 30 AMP FUSE SOCKET

Overload protection.

N. MUTE BUTTON

Mute all alerts.

3.3 AIR BRAKE CONTROL PANEL

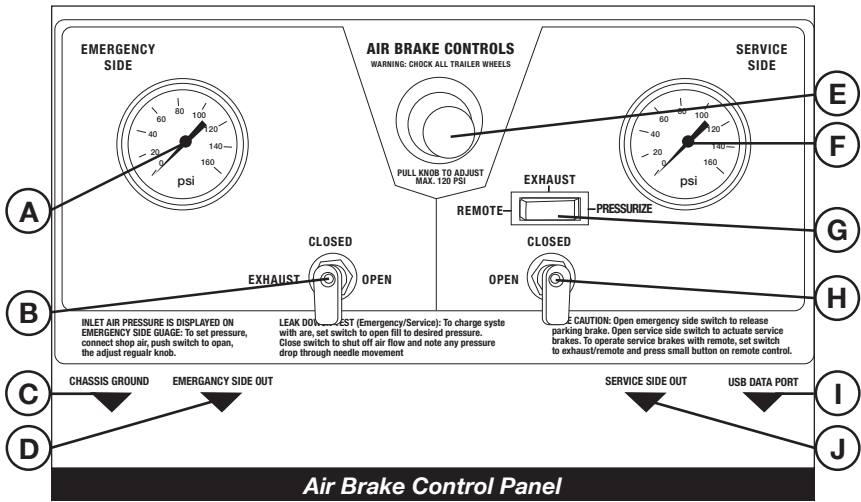

A. Emergency-Side Air Pressure Gauge

B. Emergency-Side Air Ball Valve

C. Chassis Ground Outlet

D. Emergency-Side Out

E. Air-Regulator Knob

F. Service-Side Air Pressure Gauge

G. Service-Side Brake Control Switch

H. Service-Side Air Ball Valve

I. USB Data Port (used for firmware updates)

J. Service-Side Out

PART 4: SET-UP

4.1 CHOOSING A BATTERY

The MUTT® is a 12/24V DC device. Attempting to power your MUTT® with anything other than a 12 or 24 volt DC power source will destroy the internal circuitry and void your warranty.

Manufacturer's Suggested Battery: Group 31. MUTT® will auto detect 12 or 24 volts. If 24 volts is required, two smaller 12 volt batteries can be used, but they must be wired in series.

- Battery Voltage: 12/24V DC
- Battery Type: Lead Acid
- Battery Compartment Dimensions: 14" W x 15 ½" H x 13" D.
- Battery Protection: Inline 30A fuse for overcharge.
- Battery must be clean and leak free.
- Identify battery polarity.
- Attach ring terminal with red heat shrink to positive (+) side and ring terminal with black heat shrink to negative (-) side. Also see warning indicators on pg. 4. Connections must only be made to clean terminal rings.
- Any loose or corroded connectors may cause misdiagnosis or result in erroneous readings.
- Use fully charged battery.

DC POWER

Do not plug directly into AC wall outlet

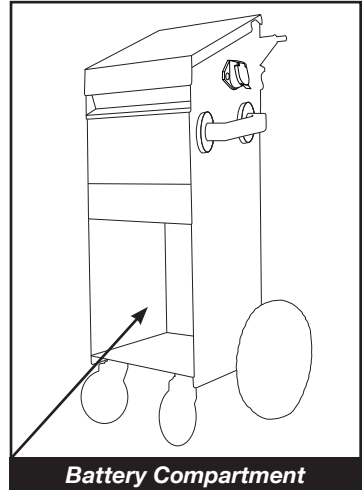

WARNING

DO NOT Use 24V On 12V Circuits

STANDARD 12V WIRING CONFIGURATION

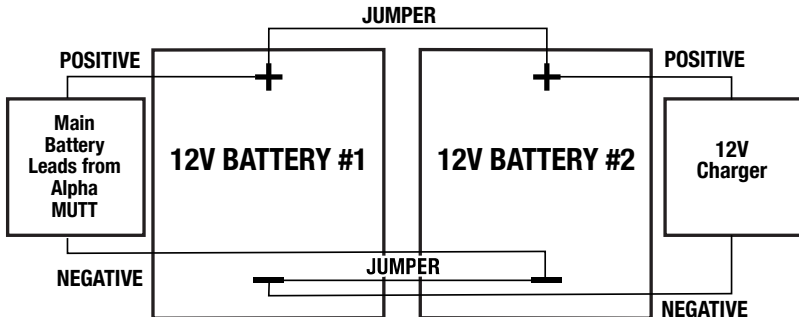

4.2 LIFTING THE UNIT

The MUTT® has three handles for use in maneuvering the unit. It should be noted that these handles are not intended to be used as lift points. If the unit needs to be lifted, you **MUST** use two people and lift from the bottom of the unit. As a safety precaution, **DO NOT** use just the handles for lifting the unit.

PART 5: PRETESTING CHECKLIST

The pretesting checklist should always be completed prior to using the MUTT®

UNIT PLACEMENT

- Place the tester on a flat, level surface.
- Chock trailer wheels to avoid rolling before testing brakes.

MAINTAIN CONNECTORS

Dielectric grease should be used on all connections to avoid corrosion. If a bad connection exists at the terminal junction, you may get an erroneous reading and the MUTT® will not work properly.

- Make sure you have a solid connection in the socket.
- Be certain the 7 pins in each plug are clean and spread to the proper size.
- Always check the MUTT® connector pins at the side of the MUTT® for proper expansion. Over time, the pins may bend in slightly resulting in a poor connection between the connector and the cable ends. A flat head screwdriver can be used to expand the pins until a tight connection is made.

CABLE TESTING PROCEDURE

The MUTT® has a special cable feature to test 7-way round pin cables for continuity. The cable testing feature can be used to test a tractor's cable or the supplied MUTT® cable. All cables should be tested prior to MUTT® operation.

- Insert each end of the cable into both side connectors on the MUTT®. Be sure to push the cable ends in firmly until they reach the bottom of the connector.
- Turn Power Source Switch to a desired power supply.
- Once the power is selected, the green lights around the control knob will blink and disappear one at a time until only the Ground Integrity Indicator remains solid green. Once the initial check has been performed, poor cable conditions will be shown by a blinking light for the problem circuit.
- If the cable has an open circuit or continuity problem, the corresponding circuit will flash repeatedly.
- Further testing can be performed by selecting each circuit individually via the control knob or remote. When an open circuit is detected, the LED for the circuit will flash and an audible alert will be heard.

PART 6: GENERAL CONTROLS AND OPERATIONS

6.1 INITIAL START-UP AND SHUTDOWN

All functions of the MUTT®, including air brake controls, require the Power Source Switch to be in BATTERY or EXTERNAL position.

POWERING UP

1. Push the Power Source Switch to BATTERY or EXTERNAL.

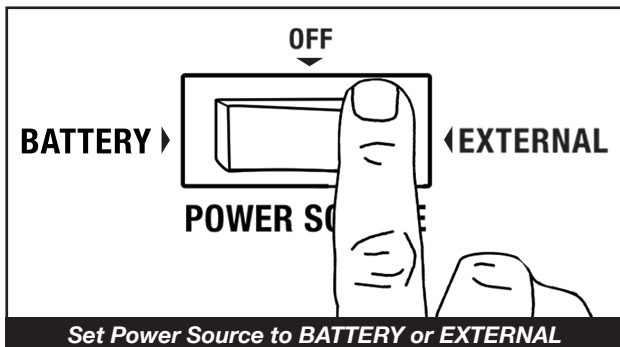

POWERING DOWN

1. Prior to shutting down, exhaust all air from the brake lines and return all air control switches to the CLOSED position.
2. Push the Power Source Switch to the OFF position.

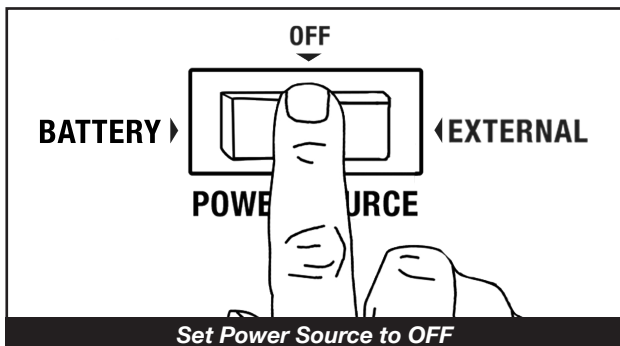

NOTE: Turning the power off will disengage the service brakes but **NOT** the emergency/parking brakes. Exhausting the emergency-side air will engage the spring/parking brakes. See pg. 26 for exhausting/dumping air pressure.

6.2 AUTO SHUTDOWN FEATURE

If left inactive for a period of 20 minutes, the MUTT® enters a Sleep Mode and powers down.

- A sound is emitted every 20 seconds during Sleep Mode.
- Activation of the Control Knob will cancel Sleep Mode.

6.3 USING THE 3-BUTTON REMOTE CONTROL

The included remote control(s) is preprogrammed to your MUTT® and should never lose its programming. In the event that you suspect your remote has lost its programming, contact Technical Support at 888-786-7899 or email tech247@ipatools.com.

HOW TO PROGRAM THE 3-BUTTON REMOTE

1. Press and hold the On/Off Button while turning on the MUTT®.
2. Continue to hold for two seconds.
3. Your Remote Control is now programmed.

HOW TO USE THE WIRELESS REMOTE

1. UP ARROW

Press and release to select the next circuit in a clockwise rotation. Press and hold for five seconds to activate All Circuits On Mode.

2. DOWN ARROW

Press and release to select the next circuit in a counterclockwise rotation. Press and hold for five seconds to turn on hazard lights.

3. ON/OFF

Press and release to engage/disengage air brakes.

4. REMOTE CONFIRMATION INDICATOR

Press any of the buttons (1, 2, 3) and the blue light (4) will illuminate to confirm the battery power of the remote.

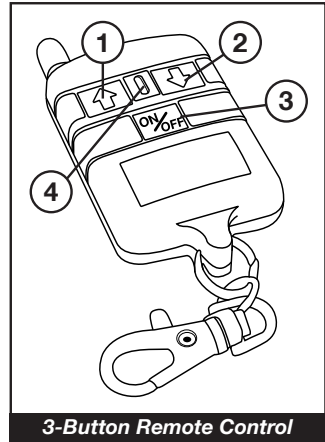

NOTE: Inclement weather, nearby power transformers and closely parked trailers may reduce the remote signal.

The supplied key fob battery for the remote control is 12V, Alkaline Energizer type A23. A Gold Peak type 23A or Duracell MN21 battery can also be used.

6.4 USING THE 12-BUTTON REMOTE CONTROL

The included remote control(s) is preprogrammed to your MUTT® and should never lose its programming. In the event that you suspect your remote has lost its programming, contact Technical Support at 888-786-7899 or email tech247@ipatools.com.

HOW TO PROGRAM THE 12-BUTTON REMOTE

1. Press and hold the Clearance Button while turning the Trailer Tester's main power ON.
2. Continue to hold the button for two seconds and then release.
3. Your Remote Control is now programmed.

HOW TO USE THE 12-BUTTON REMOTE

1. CIRCUIT SELECTION

Pressing these buttons will select the corresponding circuit on the MUTT® (Pressing and holding the ABS/AUX or Brake Light Buttons will latch both circuits on.)

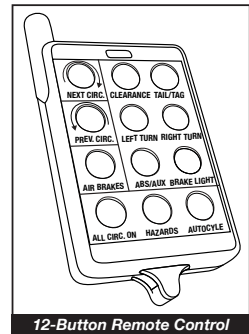

6.5 Using the Tablet

The Alpha MUTT® comes equipped with a tablet that provides leading-edge technology in performance, battery life, screen resolution and security integration.

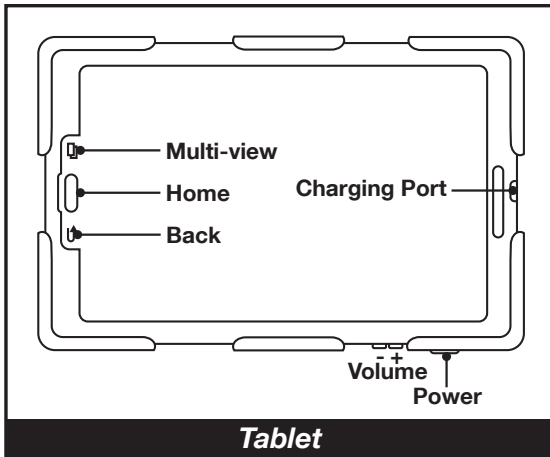

TABLET BUTTONS

The tablet features several stationary buttons which provide quick access to important features. These buttons include POWER, VOLUME, MULTI-VIEW, HOME and BACK. You will find that using the Back Button will be very helpful during normal operation of the Trailer Tester Application. To view all open applications or force close, press the Multi-View Button.

BLUETOOTH® CONNECTION (BLE)

The tablet controls the trailer tester through a Bluetooth® connection. The trailer tester is operated by 4.0 or newer BLE (Bluetooth® Low Energy) technology. This technology provides faster response times at longer distances.

If the BLE connection is lost during operation, you can attempt to reestablish the connection by accessing the BLE Connection Button in the settings menu. Otherwise, shut down the app and cycle power to the trailer tester.

GENERAL TABLET OPERATION

The tablet operate just like any other Android device. If you are unfamiliar with these systems, here are a few quick tips:

- All settings and quick tablet options can be accessed by swiping from the top down.
- All documents, images and videos are stored in a folder named "FILES".
- You can extend battery life by limiting tablet performance. Access the Battery Power Saving menu through the Settings screen.
- Charging - The tablet's charge port is located at the top center. It accepts the standard micro USB cable and charges using 5V at up to 2 amps.
- Emailing - Any email can be set up on the tablet.

OPERATING THE APP

Your Trailer Tester Application can be found on the Home screen of the tablet. Press the icon to launch the application. The application is designed to be intuitive and easy to use. Review the Application Overview Guide for basic operation flow.

1. APPLICATION SETUP

Password-protected user accounts can be created for each tablet. To access the Settings menu, you must sign in as administrator. By default, the administrator password is set as ADMIN.

2. COMPANY INFORMATION

In the Settings menu, enter your company's information.

3. FILE-SAVING STRUCTURE

You can choose the naming and file extension format by which the report will save each inspection report. In the Settings menu, choose your preferred method file names do not get overwritten.

4. ENABLING AND DISABLING APPLICATION FEATURES

Users can decide which features of the application appear in normal testing screens by enabling or disabling them in the Settings menu.

See Application Overview Guide included with tablet for more instructions.

PART 7: ELECTRICAL/LIGHTING TESTING

Complete the pretesting checklist prior to all testing procedures.

The MUTT[®] is microprocessor controlled and features a special diagnostic firmware, designed to seamlessly integrate with your preferred methods of testing. The MUTT[®] will power the selected electrical circuits and instantly alert you to any signs of a faulty condition. **To properly utilize the diagnostic features, a complete scan of the trailer's electrical system should be performed at the front of the trailer using the MUTT[®] prior to a walk-around inspection.** If any wiring faults are present, the MUTT[®] will blink or sound, alerting you to the issue. Only a one-time, walk-around/visual inspection is needed to confirm that each individual light bulb is properly illuminating.

NOTE: Some advanced functions may not be listed on the face panel, so it's important to read the manual in its entirety to ensure that you are getting the full use of this diagnostic system.

7.1 SELECTING A CIRCUIT

Circuits can be selected for testing manually, via remote control or by initiating Auto Cycle Mode.

OPERATING WITH MANUAL CONTROL

1. Turn the Control Knob to select a circuit. The Control Knob is automatically set to Ground Integrity when power is turned on.

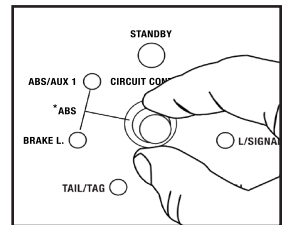

OPERATING WITH THE REMOTE CONTROL

1. Press and release the Up Arrow to select the next circuit in a clockwise rotation.
2. Press and release the Down Arrow to select the next circuit in a counterclockwise rotation.

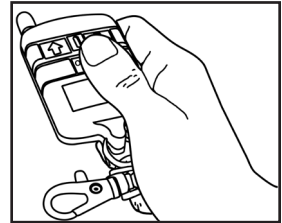

OPERATING WITH THE BLUETOOTH[®] TABLET

1. See Section 6.5 on pg. 15.

AUTO CYCLE MODE

Auto Cycle Mode automatically tests one circuit at a time in a clockwise rotation.

1. Press and release the Control Knob. The AUX 2 Indicator should illuminate.
2. A five second delay commences between circuit sections.
3. Circuits are automatically tested one at a time in a clockwise rotation.
4. To cancel Auto Cycle Mode, momentarily press and release or by rotating the Control Knob.

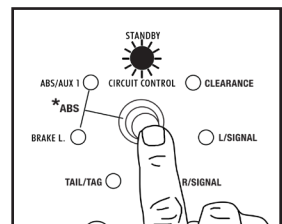

NOTE: Auto Cycle Mode does not work when ABS or Brake Light Circuits are selected.

7.2 GROUND INTEGRITY TEST

Each time the MUTT® is powered on, it automatically runs a Ground Integrity Test. A good ground connection must be established for the MUTT® to operate a trailer's electrical system.

1. Immediately after power up, the green lights around the Control Knob will illuminate.
2. A solid/healthy ground connection is indicated by a steadily illuminated Ground Integrity Indicator.
3. Bad/poor ground or bad cable condition is indicated by all of the LEDs blinking simultaneously. See ESTABLISHING A CHASSIS GROUND below.
4. When one or more green circuit LEDs blink while the Ground Integrity Indicator is steadily illuminated, it indicates that a solid ground has been established, but an open circuit has been detected. Refer to OPEN CIRCUIT on pg. 19.

CHASSIS AND PIN GROUNDS

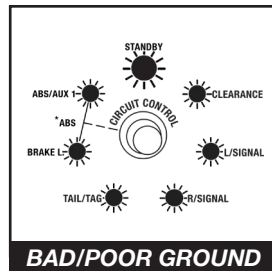
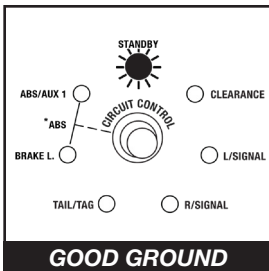

A poor ground warning may be an indication that the connected trailer is only wired for chassis ground. There are two ground types. 1) Pin Ground: The ground wire from each light assembly is wired through the main harness up into the trailer plug. 2) Chassis Ground: The ground wire from each light assembly is grounded directly to the trailer chassis. Ground with the truck is established at the king pin.

ESTABLISHING A CHASSIS GROUND

1. To simulate the king pin on a chassis ground connection and bypass the ground integrity fault, plug a chassis ground cable into the MUTT®'s Chassis Ground Outlet.
2. Attach the other end of the chassis ground cable to the chassis of the trailer.
3. Be sure that you are attaching to a clean, dry metal for an effective ground.

DO NOT
Assume That a Bad Ground
Warning is a Result of a
Faulty Trailer. Check Cable
Connection.

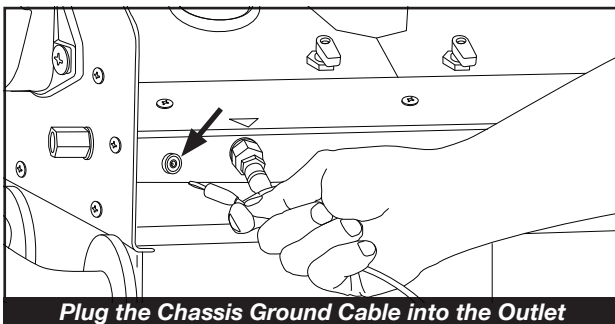

7.3 FAULT INDICATION

OPEN CIRCUIT

When the MUTT® senses no load, it is often a symptom of a disconnected wire, cut wire, poor pin connection or bad return ground. The MUTT® can detect open circuits in two ways.

1. During Ground Integrity Test: An individual circuit will blink and no audible alerts will be present.
2. During circuit selection: The selected circuit's LED will blink, while simultaneously the Open Circuit Indicator will flash. The MUTT® will also provide an audible alert (beep).

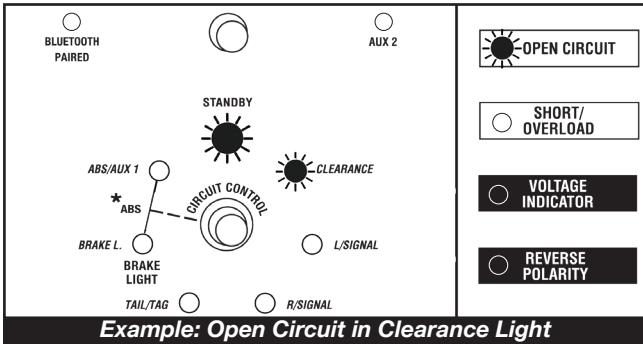

Example: The MUTT® detects an open circuit in the Clearance Light Circuit. The Clearance LED will blink, the Open Circuit Indicator will flash and the MUTT® will beep.

NOTE: Open Circuit Indicator will only illuminate during circuit selection.

CROSSED CIRCUITS

The MUTT® indicates that two or more circuits are back feeding or crossed. This can be a symptom of two wires in the same harness wearing through their insulated coating and connecting.

1. When a crossed circuit is identified, the selected circuit LED will illuminate steadily and the circuit it is crossed with will flash. The MUTT® will also provide an audible alert (beep).

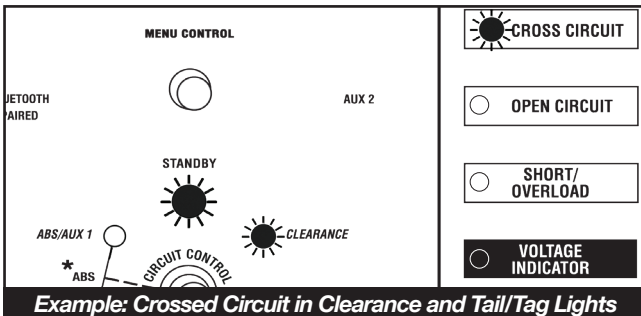

Example: The MUTT® detects that the Clearance and Tail/Tag are crossed while the Clearance Circuit is selected. The Clearance LED will illuminate, the Tail/Tag LED will flash and the MUTT® will beep.

NOTE: In some cases, a crossed circuit may be a normal function of advanced diagnostic testing, such as with certain ABS systems.

SHORT/OVERLOADED CIRCUIT

Short circuits or overloads can occur when a positive/hot wire touches ground. They can also occur due to faulty lights or connectors.

1. If a short or overloaded circuit is suspected, the MUTT® will instantly stop powering the circuit.
2. The Short/Overload Warning Indicator should flash, along with the selected circuit's LED.
3. The MUTT® will now automatically enter Pulsar® Mode. During Pulsar® Mode, the MUTT® will attempt to reapply power to the faulty circuit every three seconds for an indefinite period of time. After power is applied, if a short is still present, steps 1-3 will automatically repeat.

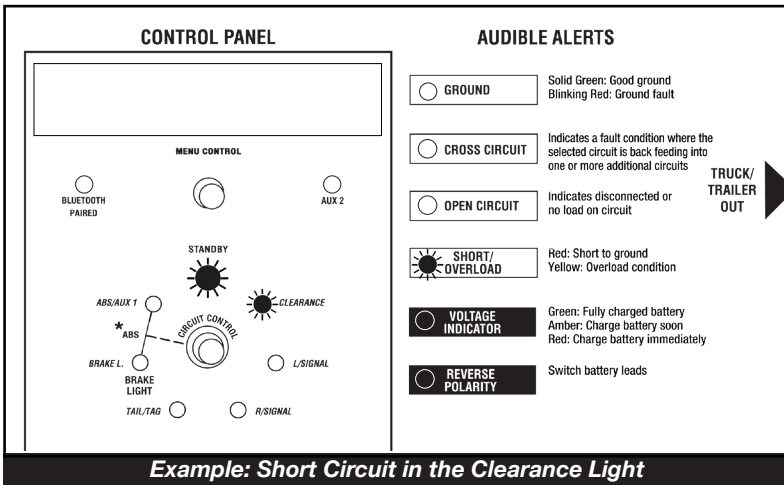

Example: The MUTT® detects a short in the Clearance Light Circuit. The Clearance LED and Overload Warning Indicator will flash and a warning beep will sound. The MUTT® will now enter Pulsar® Mode.

NOTE: Pulsar® Mode can be a useful troubleshooting tool for finding dead and intermittent shorts.

7.4 ACTIVATING HAZARD LIGHTS:

The four-way flashers on the vehicle can be activated manually or with the remote control.

MANUALLY

1. To activate, press the Hazard Button.

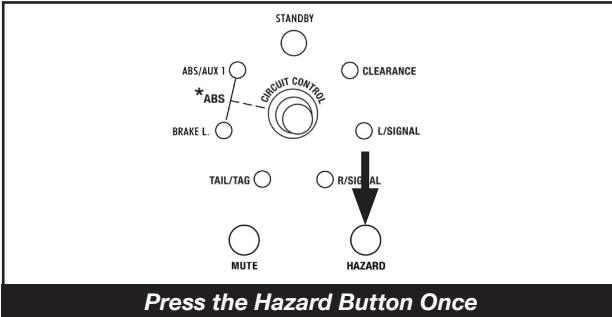

2. To deactivate, press the Hazard Button again.

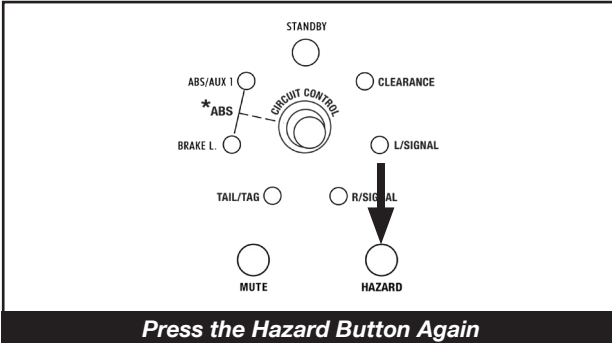

REMOTE CONTROL

1. To activate, press and hold the Down Arrow button for five seconds.

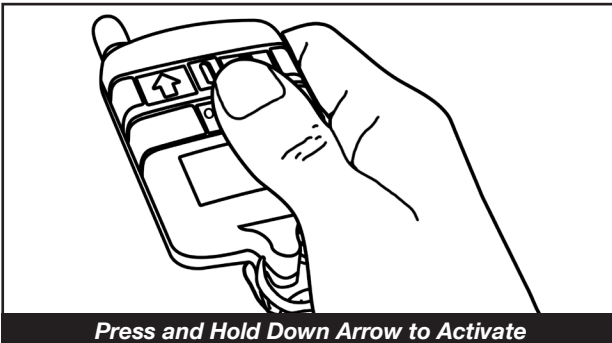

7.5 ALL CIRCUITS ON (OVERRIDE) MODE:

All Circuits On Mode will engage all electrical circuits at the same time. While short circuit sensing is operational in this mode, if a short circuit is found, the MUTT® will not be able to identify which circuit is the cause of the short. Open and crossed circuit sensing is not operational in this mode.

On trailers using incandescent bulbs, All Circuits On Mode will typically result in an overload because the amperage draw will exceed the maximum of 20 amps.

All Circuits On Mode can be accessed manually, by remote control or with the tablet.

MANUALLY

1. To activate, press and hold Control Knob for ten seconds. Listen for beep, then release.
2. To cancel, press or turn the Control Knob.

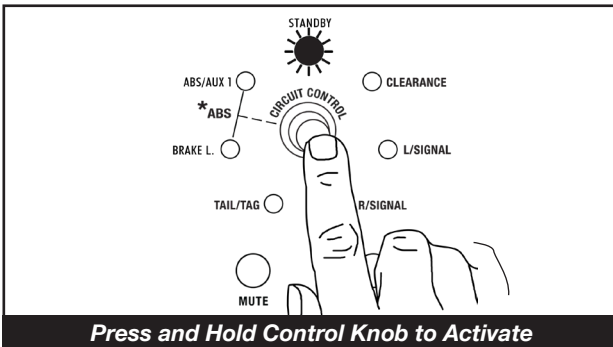

NOTE: Does not work when ABS or Brake Light Circuits are selected.

REMOTE CONTROL

1. To activate All Circuits On Mode press and hold Up Arrow for five seconds and then release.
2. To cancel, press and release either arrow.

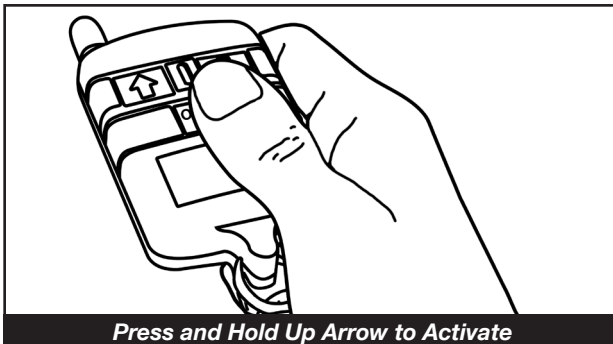

PART 8: AIR BRAKE TESTING

Complete the pretesting checklist prior to all testing procedures.



DANGER



CHOCK TRAILER WHEELS

WARNING!!! DO NOT CONNECT SHOP AIR UNTIL COMPLETING THE TESTING SET-UP PROCEDURE. FAILURE TO FULLY UNDERSTAND THESE WARNINGS CAN RESULT IN MINOR TO SERIOUS INJURY AND POSSIBLY DEATH.

8.1 TESTING SET-UP

1. Push the Power Source Switch to the OFF position.
2. Set both Emergency and Service-Side Air Ball Valves to the CLOSED position.
3. Attach gladhand hoses from the MUTT® directly to your trailer's air system, securing the red hose to the Emergency Side and the blue hose to the Service Side.
4. Connect your shop air to the Shop Air Inlet on the left-hand side of the tester.
5. Listen for any air leaks where the shop air connects to the tester, to avoid erroneous results.

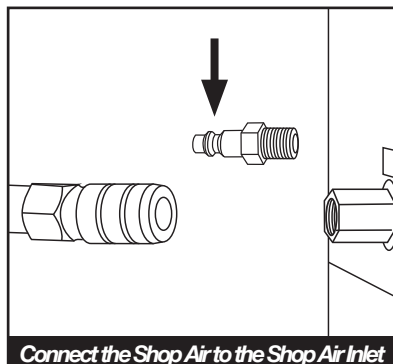
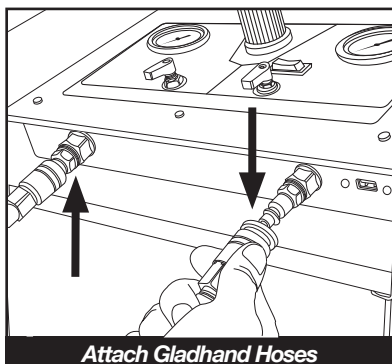
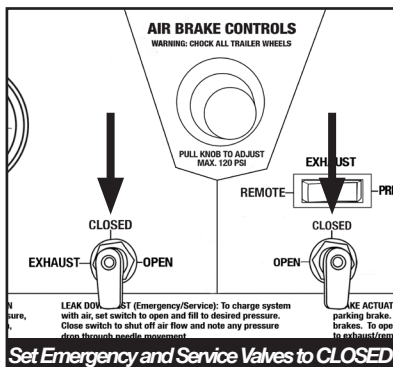
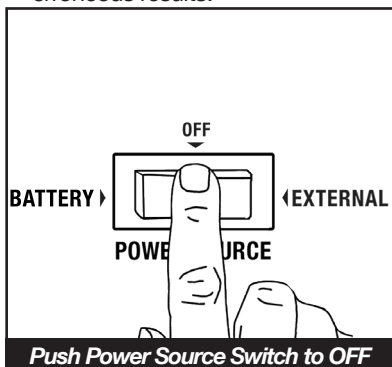

8.2 SETTING DESIRED WORKING PRESSURE

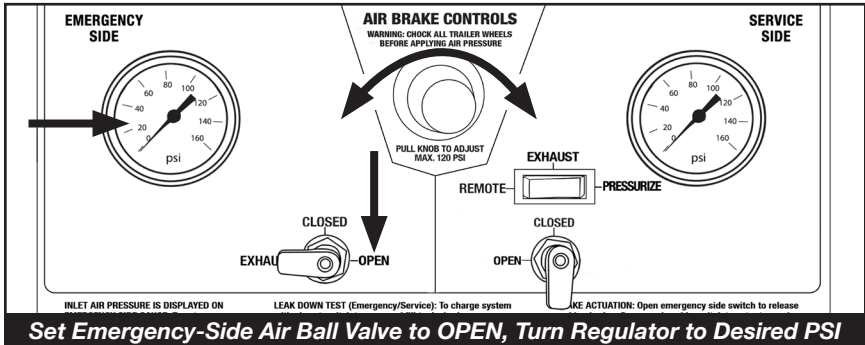

1. Turn the MUTT® on by selecting BATTERY or EXTERNAL power with the Power Source Switch.
2. Set the Emergency-Side Air Ball Valve to the OPEN position.
3. Turn Air Regulator Knob clockwise or counterclockwise until needle on the Emergency-Side Air Gauge points to the desired operating pressure. (Most shops prefer 80-100 psi during testing.)

8.3 LEAK DOWN TESTING

You must always test the Emergency Side before testing the Service Side. Trying to test the Service Side first will result in erroneous readings.

EMERGENCY-SIDE LEAK DOWN TESTING

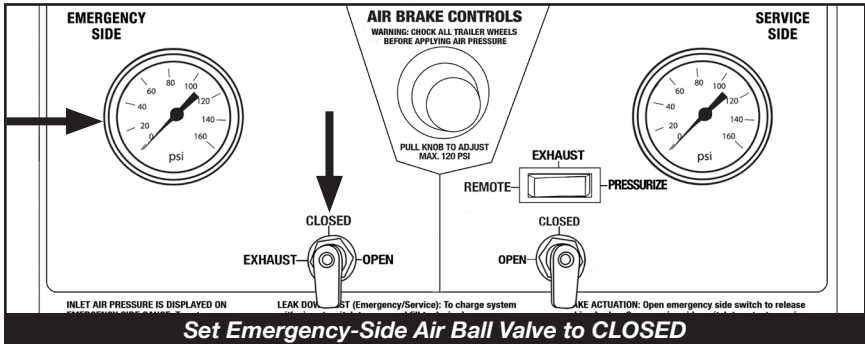

1. After setting the desired working pressure, set the Emergency-Side Air Ball Valve to the CLOSED position. This will begin the leak down test.
2. Observe the needle on the air gauge and note any PSI drop after pressure stabilizes.
3. Look for air loss according to your local specifications by noting consistent air drop over time. If air pressure continues to drop at an unacceptable rate, you can turn your air supply back on by setting the Emergency-Side Air Ball Valve to OPEN and attempt to find the source of the leak in the air system.

SERVICE-SIDE LEAK DOWN TESTING

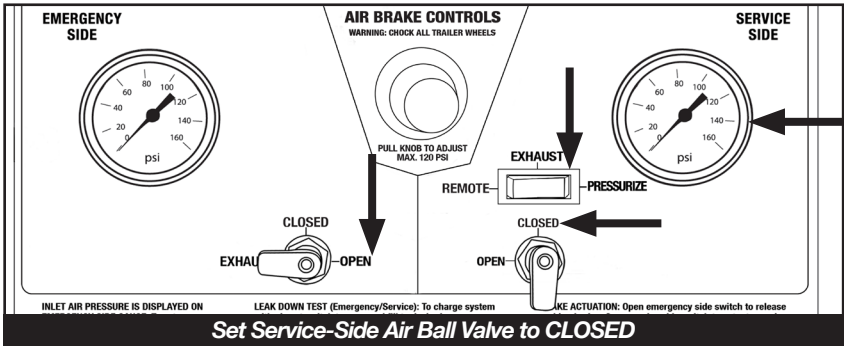

1. Set the Emergency-Side and Service-Side Air Ball Valves to the OPEN position. Set the Service-Side Brake Control Switch to the PRESSURIZE position. (This fills the Service Side air lines.)
2. Once the Service Side is fully charged, set the Service-Side Air Ball Valve to the CLOSED position.
3. Observe the needle on the air gauge and note any PSI drop after pressure stabilizes.
4. Look for air loss according to your local specifications by noting consistent air drop over time. If air pressure continues to drop at an unacceptable rate, you can turn your air supply back on by setting the Service-Side Air Ball Valve to OPEN and attempt to find the source of the leak in the air system.

8.4 ACTUATING AIR BRAKES

This feature allows you to see the slacker adjustments and the pushrod travel in real time. Brakes can be activated manually, by remote control or with the tablet.

ACTUATE BRAKES MANUALLY

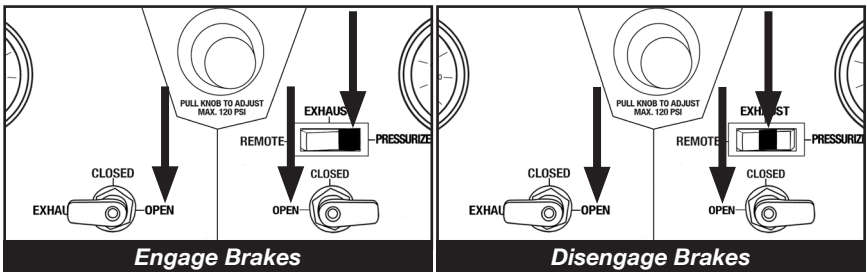

1. Charge the Emergency Side to the desired working pressure and leave both the Emergency and Service-Side Air Ball Valves in the OPEN position.
2. To engage the brakes, push the Service-Side Brake Control Switch to PRESSURIZE.
3. To disengage brakes, push the Service-Side Brake Control Switch to EXHAUST.
4. Repeat as necessary.

ACTUATE BRAKES WITH REMOTE CONTROL

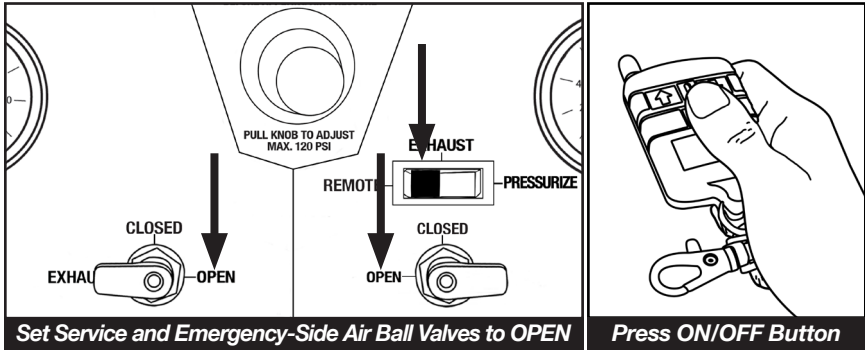

1. Charge the Emergency Side to the desired working pressure.
2. With both Air Ball Valves in OPEN position, set the Service-Side Brake Control Switch to REMOTE.
3. Point the remote in the general direction of the MUTT®.
4. Press the ON/OFF on the remote once to engage the service air brakes.
5. Press the ON/OFF on the remote again to disengage the brakes.
6. Repeat as necessary.

8.5 EMERGENCY AIR EXHAUST

To apply the parking brake at any time during testing, simply turn the Emergency-Side Air Ball Valve to the EXHAUST position.

1. Make sure the Power Source Switch on the Control Panel is on.
2. Set the Emergency-Side Air Ball Valve to the EXHAUST position to exhaust air.

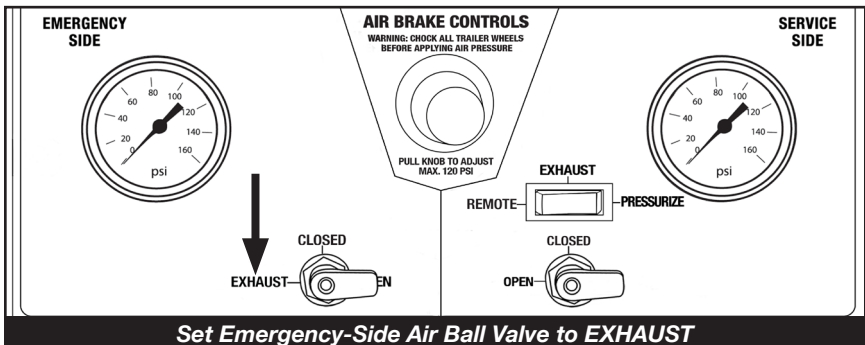

PART 9: ABS BLINK CODE DIAGNOSTICS

The MUTT® can be used to access ABS Blink Codes on trailers equipped with ABS systems. Trailers that are equipped with ABS feature an ABS Control Unit (ECU) which detects any electrical fault in the trailer ABS. Most trailers with ABS will also have a dedicated ABS lamp on the driver side. Each fault has a code. When a fault occurs, the ECU stores the code for that fault in its memory. This fault code will be displayed on the trailer ABS lamp when the proper access sequence is engaged.

ACCESSING ABS BLINK/FAULT CODES

The MUTT® provides a quick method to trigger ABS blink codes without a tractor present. Depending on the system, you will need to selectively power the Auxiliary and/or Brake Light Circuit in the correct order. Instructions on how to access several of the most common ABS systems can be found below.

Once the correct manufacturer's specific sequence is performed, you then must assess the trailer ABS lamp. The number of blinks displayed on the trailer ABS lamp will correspond to a specific ABS fault. As each manufacturer uses different access methods and each blink code has different meanings, the remainder of the ABS section will be broken down by the brand of ABS system installed on the trailer you wish to test.

Note: ABS Manufacturer Access Protocols/Blink Codes are subject to change. Please consult specific ABS manufacturer manuals for more detailed information and any discrepancies in their literature shall supersede the following directions.

9.1 MERITOR/WABCO BLINK CODES

To access Meritor/WABCO blink codes, you must select the Auxiliary Circuit to power ON/OFF/ON in one-second intervals using the following directions:

1. Make sure the trailer is stationary and wheels are properly chocked.
2. On the MUTT®, turn the Control Knob to the Auxiliary Circuit. Pause one second.
3. Turn the Control Knob to the Ground Integrity Indicator (one position to the right). Pause one second.
4. Turn the Control Knob back to the Auxiliary Circuit (one position to the left).
5. Count number of blinks on the trailer ABS lamp. Use the chart below for specific fault information.

Blink Code	Problem Area	Action
3	Sensor BUI	Determine sensor location. Check sensor installation. Make necessary repairs.
4	Sensor YE1	Determine sensor location. Check sensor installation. Make necessary repairs.
5	Sensor BU2	Determine sensor location. Check sensor installation. Make necessary repairs.
6	Sensor YE2	Verify proper electrical modulator installation. Check power supply. Make necessary corrections.
7	External ABS Modulator Valve	Verify proper electrical modulator installation. Check power supply. Make necessary corrections.
9	Internal Modulator Failure Inlet Valve #2	Verify proper installation. If code continues, contact Meritor/WABCO for assistance.
10	Internal Modulator Failure Inlet Valve #1	Verify proper installation. If code continues, contact Meritor/WABCO for assistance.
11	Internal Modulator Failure Inlet Valve	Verify proper installation. If code continues, contact Meritor/WABCO for assistance.
14	Power Supply	Verify proper electrical installation. Check power supply. Make necessary corrections.
15	ECU Failure	Verify proper installation. If code continues, contact Meritor/WABCO for assistance.
16	SAE J1 708 Failure	Internal failure, contact Meritor/WABCO.
17	SAE J2497 (PLC) Failure	Internal failure, contact Meritor/WABCO.
18	Generic I/O Failure	Verify proper electrical installation. Check power supply. Make necessary corrections.

9.2 HALDEX BLINK CODES

To access Haldex Blink Codes, you must select the Brake Light Circuit and press the Control Knob to cycle the Auxiliary Circuit the appropriate number of times using the following directions:

See table below for modes and sequences:

Mode	Description	Ignition Cycles (Hold One Second ON/OFF)
1	Simple/Wheel Speed Mode	ON, off, ON
2	Active Faults Mode	ON, off, ON, off, ON
3	Stored Faults/Clear Mode	ON, off, ON, off, ON, off, ON
4	Configuration Mode	ON, off, ON, off, ON, off, ON, off, ON

1. Make sure the trailer is stationary and the wheels are properly chocked.
2. On the MUTT®, turn the Control Knob to select Brake Light Circuit.
3. Push the Control Knob to cycle Auxiliary Circuit ON for each desired ignition cycle. The Auxiliary Circuit will flash.
5. Each Ignition Cycle must end with both Brake Light and The Auxiliary Circuits simultaneously powered. To do this, press and hold the Control Knob for five-seconds during the last ON cycle.
6. Count the number of blinks on the trailer's ABS lamp; see following charts (pg. 29-33) for specific fault info.

Item	Flash Count	Actual Fault
System OK	Light Stays On	07
Sensor 1A	1 Flash	01
Sensor 1B	2 Flashes	02
Sensor 2A	3 Flashes	03
Sensor 2B	4 Flashes	04
Sensor 3A	5 Flashes	05
Sensor 3B	6 Flashes	06
Red Valve	7 Flashes	61, 67, 71, 77, 81 & 87
Blue Valve	8 Flashes	62, 68, 72, 78, 82 & 88
Yellow Valve	9 Flashes	63, 69, 73, 79, 83 & 89
Low Voltage	10 Flashes	90
ECU Failure	11 Flashes	93, 99 & E-Codes

Fault Code	Explanation	Possible Causes	PLC Select 1M	PLC Select 2M
00	System OK (with vehicle traveling > 6 mph).	ABS is operational. Displays "00" when traveling > 6 mph.	X	X
01	Red channel wheel speed sensor wiring S1A has an Open or Short circuit.	<p>Indicates a wheel speed sensor or its wiring has short or open circuit. Disconnect the relevant sensor and measure the resistance between the two pins in the sensor connector housing.</p> <p>If sensor extensions are used, verify extension continuity and connections. Replace sensor and/or extension cable.</p> <p>The Ohm meter reading for the sensor or sensor and extension cable should be between 980 and 2350 Ohm (.98K and 2.35K Ohm) If not, replace sensor and/or extension cable.</p>	X	
02	Red channel wheel speed sensor wiring S1B has an Open or Short circuit.		X	
03	Blue channel wheel speed sensor wiring S2A has an Open or Short circuit.			X
04	Yellow channel wheel speed sensor wiring S2B has an Open or Short circuit.			X
05	Blue channel wheel speed sensor wiring S3A has an Open or Short circuit.			X
06	Yellow channel wheel speed sensor wiring S3B has an Open or Short circuit.			X
07	System OK (No Active Fault).	ABS ECU is fully operational. Displays "07" vehicle is stationary.	X	X
11	Red channel speed sensor S1A has low sensor output.	<p>Sensor or spring clip is worn or not properly adjusted, wiring open or short circuit, wheel bearing not properly adjusted (these faults will only occur at speeds of greater than 6 mph). Measure the AC voltage at the sensor in question while rotating the wheel at a rate of about one revolution every two seconds. The output should be at least 200 millivolts (0.2V AC). If this is not the case, push in the sensor until it touches the exciter and rotate the wheel again. If this doesn't correct the problem, then the sensor and the sensor block clip should be replaced.</p> <p>If sensor extensions are used, verify extension continuity and connections. Replace sensor and/or sensor cable.</p> <p>Inspect exciter teeth for minor damage or teeth filled with debris. Verify all exciters have the same number of teeth.</p> <p>Verify sensor and valve wiring/plumbing is correct.</p> <p>See side-by-side axle-by-axle configurations.</p>	X	
12	Red channel speed sensor S1B has low sensor output.		X	
13	Blue channel speed sensor S2A has low sensor output.			X
14	Yellow channel speed sensor S2B has low sensor output.			X
15	Blue channel speed sensor S3A has low sensor output.			X
16	Yellow channel speed sensor S3B gap too large. Gap should be kept to a minimum.			

Fault Code	Explanation	Possible Causes	PLC Select 1M	PLC Select 2M
21	Red channel wheel speed sensor S1A has an erratic output voltage.	Loose sensor, connection, bracket or exciter, damaged exciter, sensor is not properly adjusted or has worn cable insulation or worn sensor block clip, wheel bearing failure, wheel bearing is not properly adjusted (these faults will only occur at speeds greater than 6 mph). Measure the AC voltage at the sensor in question while rotating the wheel at a rate of about one rotation every two seconds. The output should be at least 200 millivolts (0.2V AC). If this is not the case, push in the sensor until it touches the exciter and rotate the wheel again. If this doesn't correct the problem, then the sensor should be replaced. Verify the tire and wheel size is large enough for 100 tooth exciter ring. If these faults re-occur at the same speed, inspect the exciter ring for damage. Smaller wheels and tires require 80 tooth exciter rings. Reference Tire Scale Factor Chart. Verify sensor and valve wiring/plumbing is correct. See side-by-side and axle-by-axle configurations.	X	
22	Red channel wheel speed sensor S1B has an erratic output voltage.		X	
23	Blue channel wheel speed sensor S2A has an erratic output voltage			X
24	Yellow channel wheel speed sensor S2B has an erratic output voltage.			X
25	Blue channel wheel speed sensor S3A has an erratic output voltage.			X
26	Yellow channel wheel speed sensor S3B has an erratic output voltage.			X

Occurs Only When Vehicle is Stationary

31	Auxiliary channel 1 fault (digital channel 1) output only.	PLC Select 2M Plus (ABS Auxiliary Codes). Note: These Codes are only used with PLC Select 2M Plus ABS that supports trailer Auxiliaries. Auxiliary Channel has an open circuit or the ECU (Electronic Control Unit) has an auxiliary device connected and is not programmed to be. Note: These codes do not affect ABS performance and do not illuminate the tractor trailer ABS warning lamps.		
32	Auxiliary channel 2 fault (digital channel 2) output only.			
33	Auxiliary channel 3 fault (digital channel 3) output only.			
34	Auxiliary channel 4 fault (digital channel 4) output only.			
35	Auxiliary channel 5 fault (digital channel 5) output only.			

Fault Code	Explanation	Possible Causes	PLC Select 1M	PLC Select 2M
41	Slow wheel recovery on Red valve channel.	For a 2M System, verify sensor and valve wiring/plumbing is correct. (See Side-By-Side and Axle-By-Axle configurations). Slow brake release, foundation brake mechanical faults, dry bushings, broken ABS valve, restricted piping. Check for kinks and blockage etc., incorrect air-lines, wiring.	X	
42	Slow wheel recovery on Blue valve channel.			X
43	Slow wheel recovery on Yellow valve channel.			X
61	Hold solenoid Open circuit on Red valve channel.	Modulator valve solenoid failure, solenoid connection or valve cable damage. The most likely causes include: a bad solenoid or a loose solenoid connection. Disconnect the indicated solenoid and check the resistance at the solenoid pins. Check the female terminals on the connector for excessive pin spread or corrosion. Replace defective hardware as required and retest.	X	
62	Hold solenoid Open circuit on Blue valve channel.			X
63	Hold solenoid Open circuit on Yellow valve channel.			X
67	Dump solenoid Open circuit on Red valve channel.		X	
68	Dump solenoid Open circuit on Blue valve channel.			X
69	Dump solenoid Open circuit on Yellow valve channel.			X
71	Hold solenoid Short circuit to ground on Red valve channel.	Modulator valve solenoid failure or valve cable damage. The most likely causes include: a damaged cable or solenoid. An example of this is a worn or chafed cable that has exposed wires contacting the trailer. Disconnect the indicated solenoid and check the resistance at the solenoid pins.	X	
72	Hold solenoid Short circuit to ground on Blue valve channel.			X
73	Hold solenoid Short circuit to ground on Yellow valve channel.			X
77	Dump solenoid Short circuit to ground on Red valve channel.		X	
78	Dump solenoid Short circuit to ground on Blue valve channel.			X
79	Dump solenoid Short circuit to ground on Yellow valve channel.		X	

Fault Code	Explanation	Possible Causes	PLC Select 1M	PLC Select 2M
80	Output leakage or poor insulation on any of the valve channels.	Modulator valve solenoid failure or valve cable damage. Indicates that the solenoid or its cable has a short circuit to positive power (12V DC). The most likely cause is a damaged cable or solenoid. Disconnect the indicated solenoid and check the resistance at the solenoid pins. If solenoid checks good and 80-89 code still exists, check ECU.	X	X
81	Hold solenoid short circuit to Permanent Power on Red valve channel.		X	
82	Hold solenoid short circuit to Permanent Power on Blue valve channel.			X
83	Hold solenoid short circuit to Permanent Power on Yellow valve channel.			X
87	Dump solenoid out shorted to Permanent Power on Red valve channel.		X	
88	Dump solenoid out shorted to Permanent Power on Blue valve channel.			X
89	Dump solenoid out shorted to Permanent Power on Yellow valve channel.			X
90	Low supply voltage fault. This code is not stored in memory.	Verify 12V DC power source. Do Not Use Battery Charger as Power Supply. ECU minimum operating voltage is 8.5V DC.	X	X
91	No internal ABS ECU solenoid voltage available.	Verify permanent power is present.	X	X
92	Power input over voltage fault.	Verify 12V DC power source. Do Not Use Battery Charger as Power Supply. ECU maximum operating voltage is 16V DC.	X	X
93	Short circuit on ABS ECU internal relay.	Replace ECU.	X	X
99	ABS Corrupt Memory.		X	X
9A	ABS Corrupt Memory.		X	

9.3 BENDIX® BLINK CODES

To access Bendix® Blink Codes you must select the Auxiliary Circuit and press the Control Knob to cycle the Brake Light Circuit the appropriate number of times using the following directions:

See table below for modes and sequences:

Mode	Cycle Brake Light Power
Display Active DTCs	3 Times
Display Inactive DTCs	4 Times
Clear Active DTCs	5 Times
Display Configuration	6 Times
Display Odometer Mileage	7 Times
Reset Configuration	8 Times

1. Make sure the trailer is stationary and wheels are properly chocked.
2. On the MUTT®, turn the Control Knob to select the Auxiliary Circuit.
3. Push the Control Knob to cycle the Brake Light Circuit for each desired cycle in one-second intervals. The Brake Light Circuit will flash.
4. Count the number of blinks on the Trailer's ABS Lamp. See chart below for specific fault info.

NOTE: Blink code “Digits” are separated by a one-second pause.

1st Digit	2nd Digit	Fault Description	Repair Information	J1587 (SID)	J1587 (FMI)
10	10	No Faults.	ABS system fully operational - no faults detected.	1	0

WHEEL SPEED SENSORS (WSS)

2	1	SL Sensor signal valid - large gap.	Dynamic Wheel Speed Sensor Fault.	1	0
3	1	SR Sensor signal valid - large air gap.		2	0
4	1	SAL Sensor signal valid - large air gap.		3	0
5	1	SAR Sensor signal valid - large air gap.		4	0
2	2	SL Sensor signal valid - loss of signal.		1	1
3	2	SR Sensor signal valid - loss of signal.		2	1
4	2	SAL Sensor signal valid - loss of signal.		3	1
5	2	SAR Sensor signal valid - loss of signal.		4	1
2	3	SL Sensor signal valid - noisy.		1	2
3	3	SR Sensor signal valid - noisy.		2	2
4	3	SAL Sensor signal valid - noisy.	3	2	
5	3	SAR Sensor signal valid - noisy.	4	2	
2	4	SL Sensor shorted or open.	Static Wheel Speed Sensor Fault.	1	4 or 5
3	4	SR Sensor shorted or open.		2	4 or 5
4	4	SAL Sensor shorted or open.		3	4 or 5
5	4	SAR Sensor shorted or open.		4	4 or 5
2	5	SL Tire diameter out of range.	Verify correct tire size as desired. Verify proper tire inflation. Verify correct number of exciter-ring teeth. Verify that the ECU has the proper tire size settings.	1	13
3	5	SR Tire diameter out of range.		2	13
4	5	SAL Tire diameter out of range.		3	13
5	5	SAR Tire diameter out of range.		4	13

4	6	SAL Sensor configuration error.	Verify correct ABS configuration using blink codes or other diagnostic tools.	3	13
5	6	SAR Sensor configuration error.	If needed, reset to the default ABS configuration and power-up to initiate auto-configuration.	4	13

POWER

6	1	Over-voltage.	Power supply diagnostic trouble code.	251	3
6	2	Low-voltage.	Power supply diagnostic trouble code.	251	4
6	3	Excessive power line resistance.	Power supply diagnostic trouble code.	251	13

MODULATOR (MOD)

7	1	MOD1 Hold solenoid shorted or open.	Clear faults. If faults return, replace the TABS-6 Module.	42	3,4,5 6 or 12	
7	2	MOD1 Release solenoid shorted or open.		48		3,4,5 6 or 12
8	1	MOD2 Hold solenoid shorted or open.	Static ABS Modulator Fault.	43	3,4,5 6 or 12	
9	1	MOD3 Hold solenoid shorted or open.		44		3,4,5 6 or 12
8	2	MOD2 Release solenoid shorted or open.		49		3,4,5 6 or 12
9	2	MOD3 Release solenoid shorted or open.		50		3,4,5 6 or 12
7	3	MOD1 ABS modulator dynamic error.		Dynamic ABS Modulator Fault.		7
8	3	MOD2 ABS modulator dynamic error.	8		7	
9	3	MOD3 ABS modulator dynamic error.	9		7	
8	4	MOD2 Valve configuration error.	Verify correct ABS configuration using blink codes or other diagnostic tools.	8	13	
9	4	MOD3 Valve configuration error.	If needed, reset to the default ABS configuration and power-up to initiate auto-configuration.	9	13	

COMMON

10	1	Valve MOD1/2 low-side switch shorted to ground.	Check for corroded/damaged wiring or connectors between the ECU and MOD. At the MOD harness connector, verify: No continuity from modulator/AUX leads to ground. After repairs or if no issues found, then clear faults. If faults return, replace the TABS-6 Module.	7	4
10	2	Valve MOD3 low-side switch shorted to ground.		9	4
10	3	ABS modulator dynamic error - all valves.	Dynamic ABS Modulator Fault.	7	7
10	4	Excessive ABS activity.	Dynamic Wheel Speed Sensor Fault.	1	7

ELECTRONIC CONTROL UNIT (ECU)

11	1	ECU internal error.	<p>Check for damaged or corroded connectors. Check for damaged wiring. After repairs or if no issues found, then clear faults. If faults return, replace the TABS-6 Module.</p>	254	12
11	2	ECU configuration error.	<p>Verify correct ABS configuration using blink codes, PC-diagnostics or other off-board diagnostic tools. If needed, reset to the default ABS configuration and power-up to initiate auto-configuration.</p>	254	13

J1587 DIAGNOSTIC

12	1	J1587.	<p>Check for corroded/damaged wiring or connectors between the ECU and J1587 Diagnostic. Verify the following: -At the 18-pin ECU harness connector: (a) Continuity of the J1587 Diagnostic wiring to the lamp (auxiliary device). (b) +12V is not measured at J1587 Diagnostic lead. -At J1587 Diagnostic connector: (a) No continuity of the J1587 Diagnostic lead to ground. (b) No continuity from J1587 Diagnostic lead to any other ECU pin(s). (c) Replace/repair J1587 Diagnostic wiring or components as required.</p>	250	3,4,5 or 12
----	---	--------	---	-----	----------------

TRAILER-MOUNTED ABS INDICATOR LAMP

13	1	ABS lamp shorted or open.	<p>Check for corroded/damaged wiring or connectors between the ECU and ABS Indicator Lamp. Verify the following: -At the 5-pin or 18-pin ECU harness connector: (a) Continuity of the ABS Indicator Lamp wiring to the lamp auxiliary device). (b) +12V is not measured at ABS Indicator Lamp lead to any other ECU pin(s). -At ABS Indicator Lamp connector: (a) No continuity of the ABS Indicator Lamp lead to ground (b) No continuity from ABS Indicator Lamp lead to any other ECU pin(s). (c) Replace/repair ABS Indicator Lamp wiring or components as required.</p>	81	3,4,5 or 12
----	---	---------------------------	--	----	----------------

PART 10: TYPICAL TRAILER WIRING

Note: The standard wiring pictured below is viewed from the front of the connector. Not all trailers/vehicles are wired to this standard. The use of an electrical circuit tester is necessary to ensure proper match of vehicle's wiring to trailer's wiring. On some trailers with 6-way round plugs, the 12V wire and electric brake wire may be reversed (particularly horse trailers).

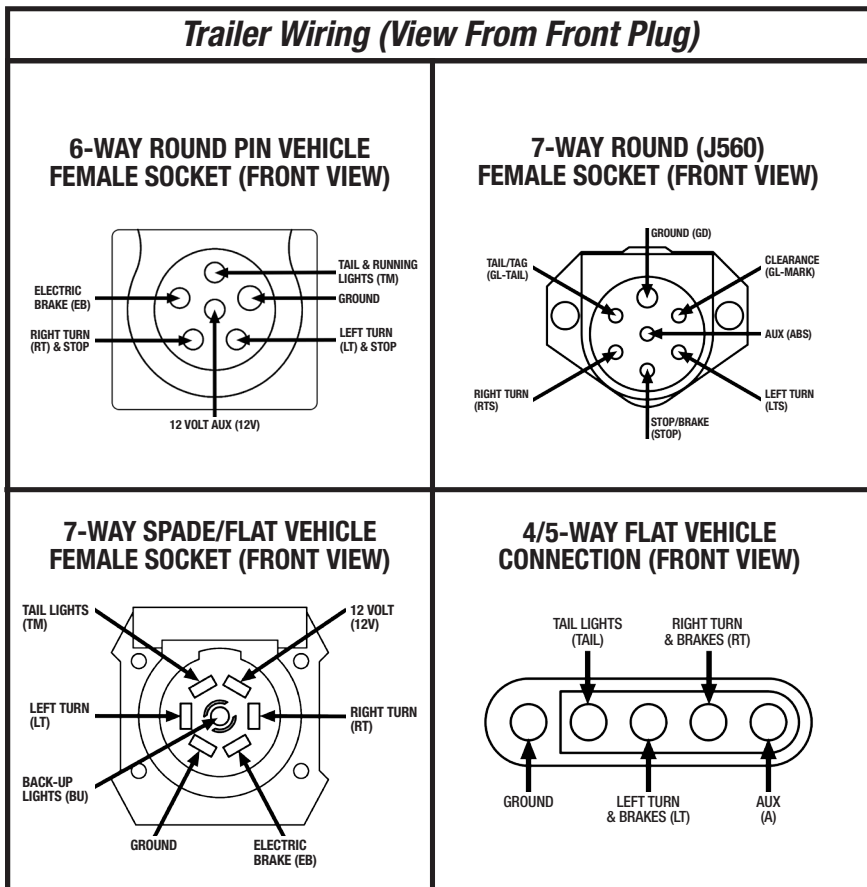

PART 11: MAINTENANCE AND STORAGE

- Switch power to OFF, remove all power cables and disconnect battery before storing and cleaning.
- Wipe surfaces down with a well-wrung, soft, damp cloth.
- Diluted dishwashing liquid or similar substance can be used in the dampened cloth if necessary.
- Dielectric grease can be used in 7-way round socket and cable, as well as battery clamps, to prevent corrosion.
- Disconnect and remove battery when placing the MUTT® into long-term storage.
- Store in a cool, dry area.

PART 12: ADDITIONAL TESTING PROCEDURES

There are many safety and operational functions to test on a trailer, but there are a few which are widely regarded as very important. With the MUTT®, these tests can be performed without the truck or tractor, quickly, accurately and in most cases, with only one person. Below are a few common system checks that can be performed using the MUTT®.

- One-man leak and shake testing throughout the trailer.
- Pushrod travel measurements.
- Slacker adjustment reading specific to the manufacturer's specifications on brake chamber and proper operation notes.
- Even brake pressure activation.
- One-man, wheel-off-ground testing for brake strength and operation.

PART 13: OPTIONAL ACCESSORIES AND RELATED PRODUCTS

#9008-DL SUPER MUTT® PRO EDITION: 12-Button Remote Control, (2) 3-Button Remote Controls, 5' 7-Way Cable, 8' Gladhands, 10A Smart Battery Charger, Face/Battery Shield and Rain Cover.

#9049M FLEET TANK SWEEPER®: (2) 17-Micron Filter, 6' Long ¾" Black Input Hose, 6' Long ¾" Black Output Hose, 5' Long ¾" Flexible Input Wand and 5' Long ½" Flexible Output Wand.

#9060C FIVE-TIRE PRESSURE EQUALIZER SYSTEM: (5) Color-Coded Air Hoses; (2) Panel-Mounted, High-Flow Regulators; (2) Panel-Mounted, Highly Accurate Air Gauges; and (5) Lock-On Air Chucks.



9008-DL



9049M



9060C

#8026 4/5 PIN TOWING MAINTENANCE KIT



#7866 4/5 PIN TRAILER HARNESS CHECKER



#8027 6-WAY ROUND PIN TOWING MAINTENANCE KIT



#7897 6-WAY ROUND PIN TRAILER CIRCUIT TESTER



#8028 7-WAY FLAT (SPADE) PIN TOWING MAINTENANCE KIT



#7893 7-WAY FLAT (SPADE) PIN TRAILER CIRCUIT TESTER



#8029 7-WAY ROUND PIN TOWING MAINTENANCE KIT



#7865L 7-WAY ROUND PIN TRACTOR TRAILER CIRCUIT TESTER



#8000 3-WAY TRAILER ADAPTER



#TSTPK1 MULTI-TRAILER TESTER JOBBER PACK



Discover other diagnostic and testing tools on our website.