

# inno. RT201/202 Velo Gripper Instruction Manual

Thank you for purchasing this INNO product.

- Please read through this manual thoroughly before use, and make sure that you follow all of the instructions carefully.
- After reading this instruction manual, store it in a safe place for future reference.

### Warning

Parts or loaded items falling from the rack can cause serious accidents, involving passers by or other cars, which may lead to serious injury or death.

- Before using this product, check the vehicle compatibility table to make sure it is compatible with your vehicle.
- Before using this product, check the type of objects that can be loaded and maximum load weights according to the type of vehicle.
- Before driving, make sure that the knob is not loose.
- Do not attempt to modify the carrier system.
- Do not use crossbars and loading items that exceed the width of the vehicle.
- This product is not for off-road use.

### Caution

There is risk of injury, or damage to the rack, vehicle, or loaded items.

- Always drive safely.
- Do not use automatic car washes.
- Load evenly.
- Remove the bed liner when it interrupts the installation of the carrier.
- Maximum load of this carrier is 1 bike or 33 lbs (15kg)

## Product Contents

① Main unit: 2

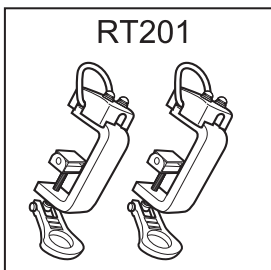

For standard

or

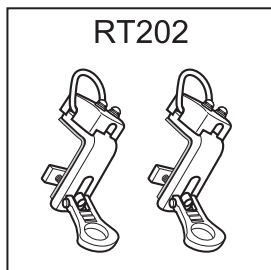

For C-channel

② Bike rod: 2

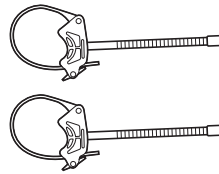

③ Plate: 2

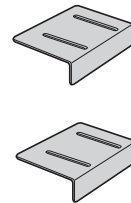

④ Hex wrench: 1



⑤ Instruction manual (this manual): 1



## Installation Procedure

**1** Clean the side rails of the truck bed where product is to be installed.

**2** Place the plate on the mounting position.

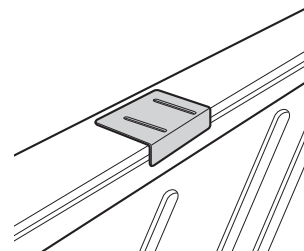

## Installation Procedure

### For standard truck / RT201

- 3** Loosen the eye bolt 1/2 way to allow the clamp to slip over the truck bed rail and centered on plate.

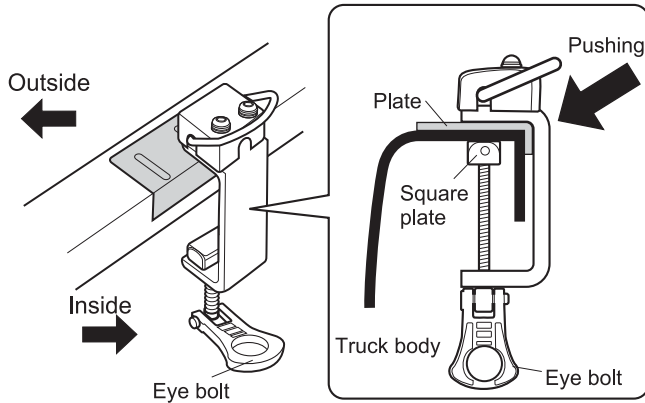

- 4** Untighten the hex bolts and remove the cap.
- 5** Place the bike rod and reattach the cap and the hex bolts but don't tighten until determining how much of the bike rod needs to be protrude from clamp.
- 6** Place bike standing up in the truck bed and strap down both front fork and seat stay by inserting straps around forks and then through buckles pulling tightly.

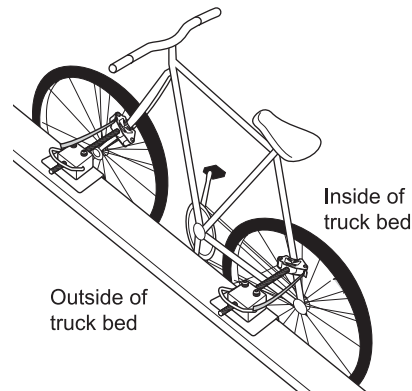
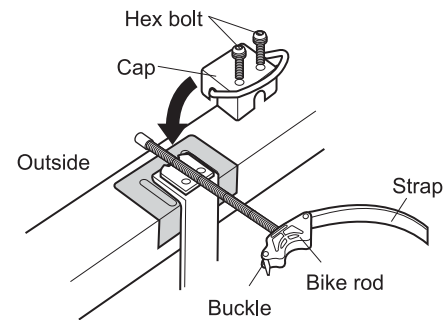

- 7** Adjust the position of the bike rod by moving in or out to line up with the bike frame, crank-arm, and/or fork. When position of the bike is most vertical, tighten hex bolts firmly by the provided wrench located on cap.

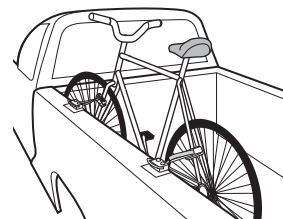
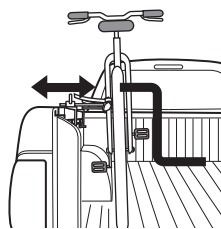

### Note

If the cranks and or pedal hit the body of the truck, it may be necessary to adjust bike position repeat steps 4 through 7 to secure or cover crank and or pedal with a protective covering as not to cause vehicle damage

## Installation Procedure

- 8 After determining that the clamps over the rail of the truck bed, tighten the eye bolt while pushing the clamp against the side wall of the truck bed. And make sure eye bolts are firmly tightened.

### ⚠ Warning

Before driving, check front and rear clamps and bars for looseness, and the eye bolt (2 locations) for looseness, if any of them are loose, re-tighten them.

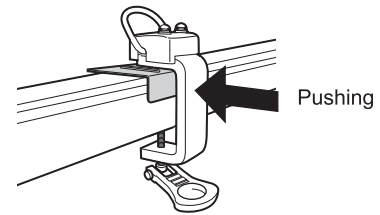
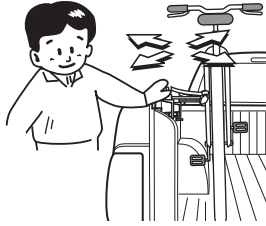

### ⚠ Caution

Please make sure you follow instruction in the attachment instruction manual correctly.

Load evenly.

Do not install the bike rods with the end sticking out from the side of vehicle.

### Tie-Down

To use tie-down:

- Maximum force of this D-ring is 66 lbs (30kgf)

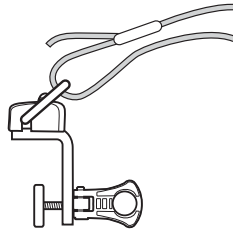

### Note

#### To lock Velo Gripper

To lock bike and clamps:  
With a tapered-end cable, thread through eye bolts and bike.  
A 5' to 6' long and smaller than 0.75 inch diameter cable is normally sufficient to lock two clamps and bike.

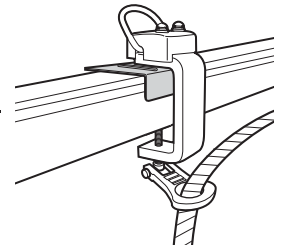

## Daily Maintenance

- Wash off dirt and mud with water.
- Wipe off dirt with a damp wet towel.
- Allow it to dry in the shade.

### ⚠ Caution

- Do not use solvents such as thinner etc.
- Do not lubricate screws or bolts.



## Checks before driving

### ● Part inspection

Clean the product, and inspect each of the parts for abnormalities. If you discover any deformed or damaged parts, discontinue use immediately and replace the parts.

### ● Storage

Store in a dry place indoors, out of direct sunlight.

