

Instruction Manual P/N:SP1574

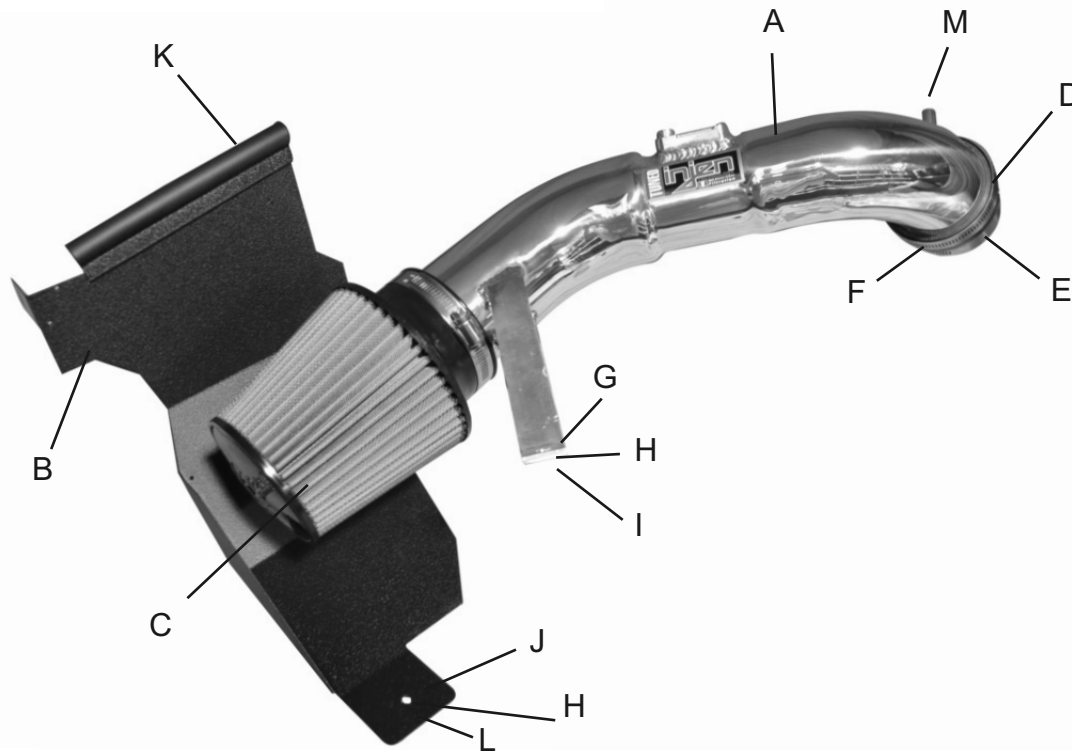

Vehicle Application:
 Make: **Honda**
 Model: **Civic**
 Year: **2016-2018**
 Engine: **2.0L 4-cyl.**

Item	QTY.	P/N	Discription
A	1	Y-SP1574	Intake Tube
B	1	#11139	Heat shield
C	1	#1063	Dry air filter
D	1	#3110	2.5"x3 step hose
E	1	#4003	#40 clamps
F	1	#4004	#48 clamps
G	1	#6020	M6 vibramounts
H	2	#6010	Fender washers
I	1	#6002	M6 nuts
J	1	#6006	M6 hex screw
K	1	#6058	Rubber trim @ 6.5" Length
L	1	#8042	Nylon spacer
M	1	#3220	10mm hose @ 2"L



WARNING: FAILURE TO FOLLOW INSTALLATION INSTRUCTIONS AND NOT USING THE PROVIDED HARDWARE MAY DAMAGE THE INTAKE SYSTEM, ENGINE AND COMPONENTS!!!
*Do not attempt to install the intake system while the engine is hot.

TOOLS REQUIRED

- 10mm Ratchet & Socket
- 8mm nut drive
- Allen key
- Flat Blade Screwdriver
- Phillips Screwdriver

Instruction Manual P/N:SP1574

NOTE: This intake kit may not work on vehicles with the following aftermarket modifications.

- Aftermarket Intercooler piping
- Aftermarket intercooler
- Turbo upgrade
- Modified body panels
- Suspension & Chassis modifications

Injen intake systems are street legal in most states unless the state is adopting to California Emissions standards. States that have adopted California emission standards include: Arizona, California, Connecticut, District of Columbia, Maine, Maryland, Massachusetts, New Jersey, New Mexico, New York, Oregon, Pennsylvania, Rhode Island, Vermont, and Washington. These states will require an California Air Resource Board Executive Order Number (CARB E.O.) for the legal use of an Injen intake system in your vehicle for use on public roads or highways. These vehicle will be considered "Legal in California only for racing vehicles competition use only, which may never be used upon a public street or highway. **Please keep your factory air box assembly for any future use.**



The SuperNano-Web filter media is a dry synthetic media that outperforms the competition. The media itself is a proprietary base blend of synthetics and cellulose. Cellulose fibers are larger than synthetic fibers, and have larger spaces between the fibers, causing contaminants to load in the depth of the media and plug the airflow path. This creates higher restriction levels and less capacity. The synthetic fibers in the SuperNano-Web media are submicron in diameter and have small interior fiber spaces, which result in more contaminants being captured on the surface of the media. This can help keep restriction levels low as the filter loads with dirt and containments



If you look at the picture to the left, you can see the Nano-fiber web on top of our base media. That web, or SuperNano-Web as we like to call it, helps trap smaller particles and protect your engine.

To Clean your filter:

Carefully remove the filter from the housing. Once removed, wipe down the housing using a clean shop towel, being careful not to knock any dirt and/or debris in the air inlet. Your filters can be cleaned by carefully vacuuming the filter media from the dirty side, or by holding the filter with one hand and carefully blowing the filter media at a 45-degree angle from the clean side using low-pressure shop air (15-20 lbs. psi).

****IT IS IMPORTANT TO NOT USE ANY CLEANERS ON THE SUPERNANO-WEB MEDIA OR APPLY ANY OIL!!!***

NOTE: DISCONNECT BATTERY BEFORE INSTALLATION!!!



1. Stock intake system shown.

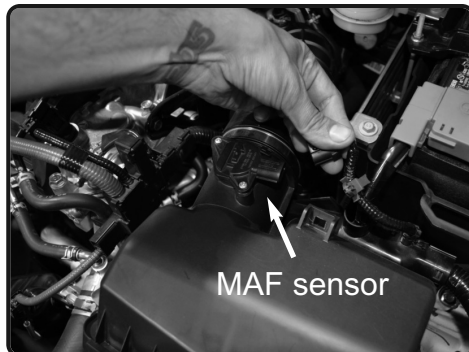

2. Disconnect the MAF sensor. Pull back harness clip from airbox.

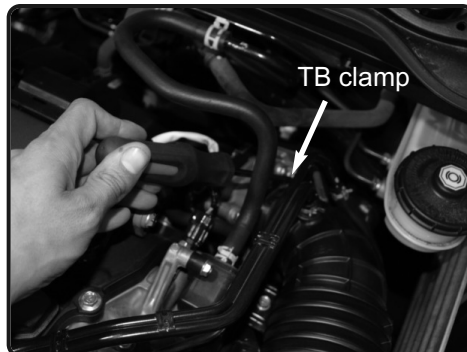

7. With phillips screwdriver, loosen the clamp on the throttle body.

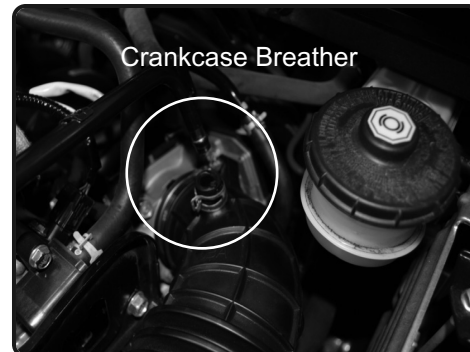

3. With pliers, remove the hard crankcase line out of the intake tube.



4. Unclip the upper half of the airbox, and remove from the vehicle.



5. Remove the plastic push clips from the front plastic cover above the radiator. Remove plastic cover.

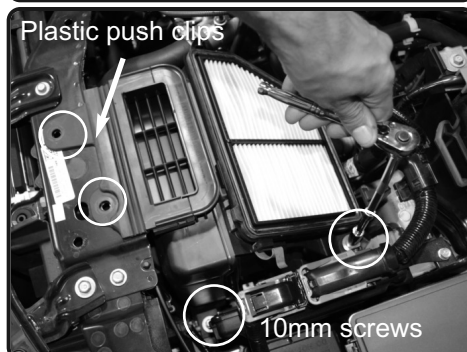

6. Pull back the 2 plastic push clips on lower part of the air box. Loosen the 2 10mm screws holding in the air box. Lift up and remove the lower part of airbox out of vehicle.



7. Loosen the OEM air box bracket out of vehicle using 10mm socket or wrench. Save 1 screw for later install.

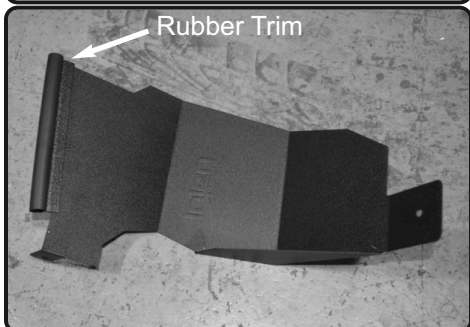

8. Attach the rubber trim to the top of the heat shield. **See last steps 25/26 for CVT transmission install.**

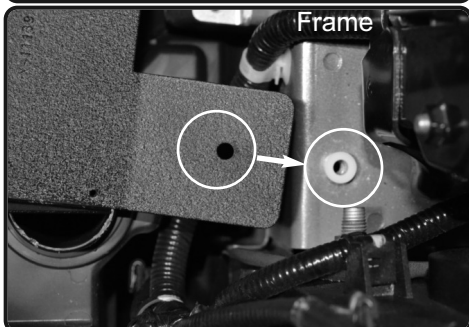

9. Position the heatshield into the vehicle. **Make sure the provided nylon spacer is between the frame and heatshield.**



10. Secure the heatshield tab using provided M6 screw and washer.

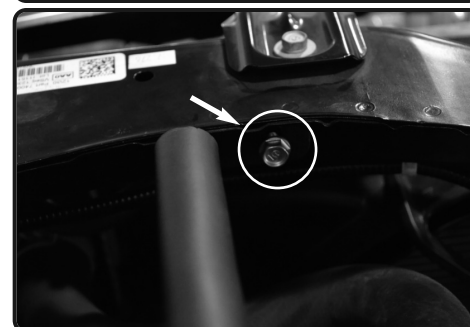

11. Now secure the back bracket to the factory air box mounting position. Secure using OEM screw from step 7.

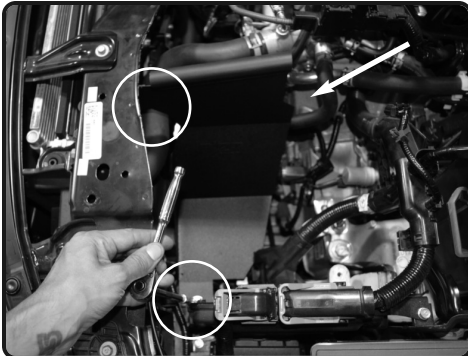

12. Secure the heat shield and tighten both screws using 10mm socket or wrench.



13. Install the vibramount to the OEM airbox threaded insert. Secure and tighten.



14. Loosen the 2 screws holding in the MAF sensor. Carefully remove the MAF sensor.

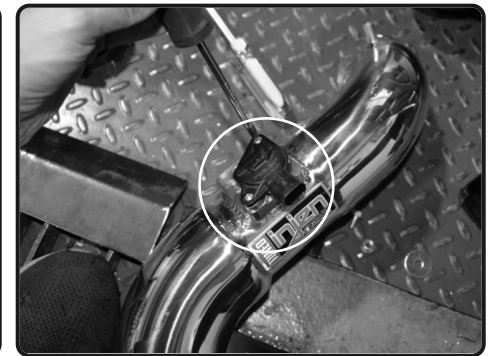

15. Install the MAF sensor into the new injen intake tube. Secure and tighten using the 2 OEM screws.



16. Install the step hose with clamps provided to the throttle body. Tighten the clamp on throttle body using 8mm nut driver.



17. Install the intake tube into vehicle and position tube to step hose and bracket to the vibramount.



18. Secure the bracket using provided M6 nut and fender washer. Tighten and secure the vibramount using 10mm socket or wrench.



19. Adjust for proper fit. Tighten the clamp on step hose using 8mm nut driver.

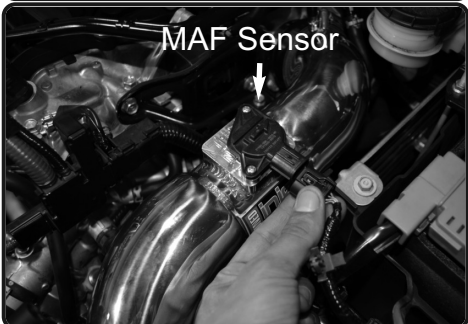

20. Re-connect the MAF sensor harness.

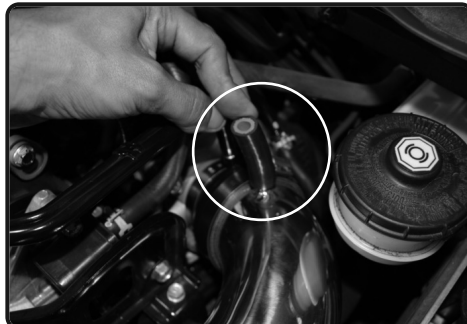

21. Install the 10mm hose to the fitting on the intake tube.



22. Now connect the crankcase hardline to the 10mm hose. Make sure the line is secured.

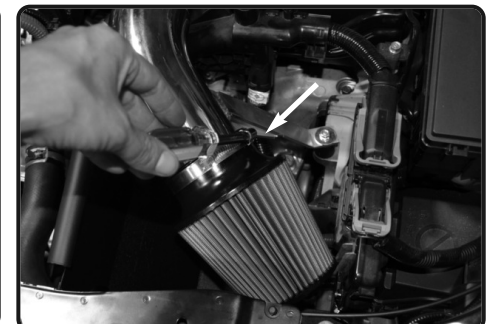

23. Now install the filter to the intake tube. Secure and tighten using 8mm nut driver.

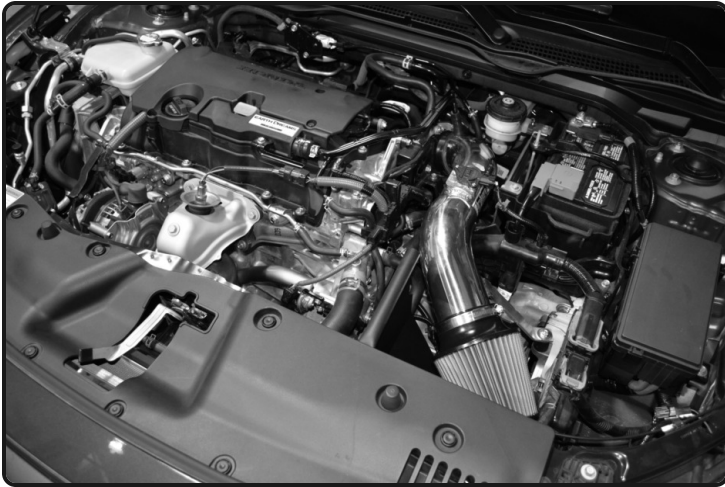

25. For CVT transmission, disconnect the harness clip.



26. Install the heatshield and place the harness on top.

Congratulations! You have just completed the installation of this intake system. Periodically, check the alignment of the intake, normal wear and tear can cause nuts and bolts to come loose. **Note: Check clearance and adjust if needed! Failure to check the alignment and adjust the intake can cause damage that will void the warranty. Injen Technology is not responsible for any damages caused by/from improper installation.**

Test Drive:

1. With the transmission in neutral or park and the parking brake engaged, start the engine. Listen for air leaks or odd noises. If air leaks are detected, secure hoses and connections. For any odd noises, inspect entire system for cause and adjust intake as needed. The Injen intake will function identically to the factory system but will be louder and more powerful.
2. Perform a road test. Listen for odd noises or rattles and fix as necessary.
3. If there are no issues, continue to enjoy your added performance from the Injen performance Intake kit.
4. Injen Technology recommends you periodically check clearance and adjust if needed! Failure to check the alignment and adjust the intake can cause damage that will void the warranty. Injen Technology is not responsible for any damages caused by/from improper installation.

1. Upon completion of the installation, reconnect the negative battery terminal before you start the engine.
2. Align the entire intake system for the best possible fit. Once the intake has been properly fitted continue to tighten all nuts, bolts and clamps.
3. Periodically, recheck the alignment of the intake system and make sure there is proper clearance around and along the length of the intake. Failure to follow proper maintenance procedures may cause damage to the intake and will void the warranty.
4. Start the engine and listen carefully for any odd noises, rattles and/or air leaks prior to taking it for a test drive. If any problems arise go back and check the vacuum lines, hoses and clamps that maybe causing leaks or rattles and correct the problem.
5. Check the filter for excessive dirt build up. Clean or replace the filter with an original Injen filter. Congratulations! You have just completed the installation of the best intake system sold on the market. Enjoy the added power and performance of your new intake system.