

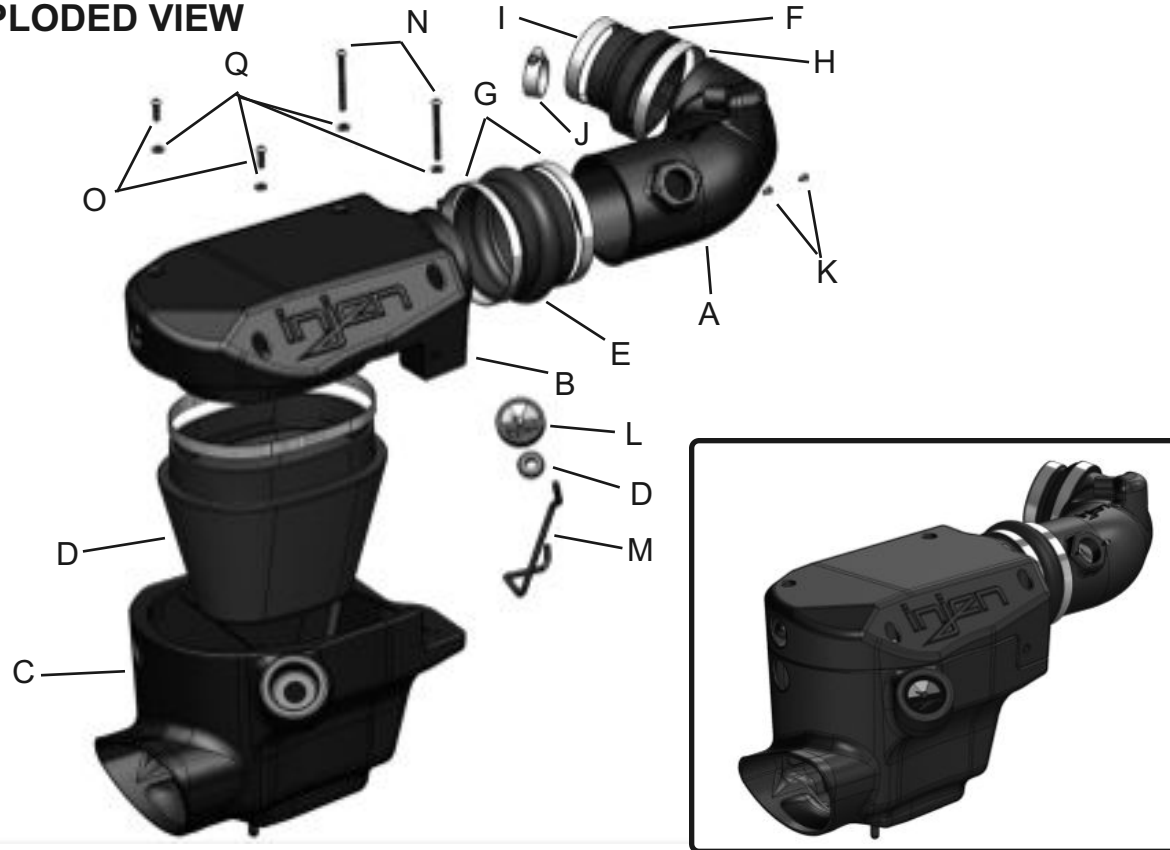

Vehicle Application:	
Make: Ford	
Model: F-250 / F-350	
Year: 2008-10	
Engine: 6.4L (TD) Powerstroke	

EXPLODED VIEW



Item	QTY.	P/N	Discription
A	1	#15059	Rotomold Tube
B	1	#15058	Rotomold Plenum
C	1	#15057	Rotomold Box
D	1	#1069	Filter
E	1	#3200	4.5" Hump Hose
F	1	#3199	4.00-3.00" Step Hose
G	2	#4014	#72 Clamps
H	1	#4006	#64 Clamp
I	1	#4004	#48 Clamp
J	1	#4017	#16 Clamp
K	2	#6047	M4X10mm Button Head Bolts
L	1	#15040	Filter Minder
M	1	#3198	3mm-16" Vacuum Hose
N	2	#6095	M6X80mm Bolt
O	2	#6099	M6x40mm bolt
P	1	#8026	Grommet
Q	4	#8047	1/2"OD rubber seal washer

<u>TOOLS REQUIRED</u>	
• 10mm Ratchet & Socket	
• 8mm nut drive	
• Allen key	
• Needle nose	
• Phillips Screwdriver	
• Pliers	

WARNING: FAILURE TO FOLLOW INSTALLATION INSTRUCTIONS AND NOT USING THE PROVIDED HARDWARE MAY DAMAGE THE INTAKE SYSTEM, ENGINE AND COMPONENTS!!!
***Do not attempt to install the intake system while the engine is hot.**
 Severe burn could result from touching hot engine components!

Report any defective or missing parts to the authorized Injen dealer you purchased this product from. Before installing any parts of this system, please read the instructions thoroughly. If you have any questions regarding installation, please contact your Injen Technology dealer. Installation DOES require some mechanical skills. A qualified mechanic is always recommended.

A Limited Lifetime Warranty to the original purchaser against defects in material and workmanship on all Injen intake systems excluding the filter element. Any and all warranty coverage is limited to the repair or replacement of the defective part only, at Injen Technology's discretion. The warranty does not cover incidental or consequential damages, nor does it cover the cost of installation or removal of the defective part or its replacement. Proof of purchase is required.

Instruction Manual P/N:EVO9002

NOTE: This intake kit may not work on vehicles with the following aftermarket modifications.

- Aftermarket Intercooler piping
- Aftermarket intercooler
- Turbo upgrade
- Modified body panels
- Suspension & Chassis modifications

Injen intake systems are street legal in most states unless the state is adopting to California Emissions standards. States that have adopted California emission standards include: Arizona, California, Connecticut, District of Columbia, Maine, Maryland, Massachusetts, New Jersey, New Mexico, New York, Oregon, Pennsylvania, Rhode Island, Vermont, and Washington. These states will require an California Air Resource Board Executive Order Number (CARB E.O.) for the legal use of an Injen intake system in your vehicle for use on public roads or highways. These vehicle will be considered "Legal in California only for racing vehicles competition use only, which may never be used upon a public street or highway. **Please keep your factory air box assembly for any future use.**



The SuperNano-Web filter media is a dry synthetic media that outperforms the competition. The media itself is a proprietary base blend of synthetics and cellulose. Cellulose fibers are larger than synthetic fibers, and have larger spaces between the fibers, causing contaminants to load in the depth of the media and plug the airflow path. This creates higher restriction levels and less capacity. The synthetic fibers in the SuperNano-Web media are submicron in diameter and have small interior fiber spaces, which result in more contaminants being captured on the surface of the media. This can help keep restriction levels low as the filter loads with dirt and containments



If you look at the picture to the left, you can see the Nano-fiber web on top of our base media. That web, or SuperNano-Web as we like to call it, helps trap smaller particles and protect your engine.

To Clean your filter:

Carefully remove the filter from the housing. Once removed, wipe down the housing using a clean shop towel, being careful not to knock any dirt and/or debris in the air inlet. Your filters can be cleaned by carefully vacuuming the filter media from the dirty side, or by holding the filter with one hand and carefully blowing the filter media at a 45-degree angle from the clean side using low-pressure shop air (15-20 lbs. psi).

****IT IS IMPORTANT TO NOT USE ANY CLEANERS ON THE SUPERNANO-WEB MEDIA OR APPLY ANY OIL!!!***

NOTE: DISCONNECT BATTERY BEFORE INSTALLATION!!!

Instruction Manual P/N:EVO9002



1. Stock intake system shown.

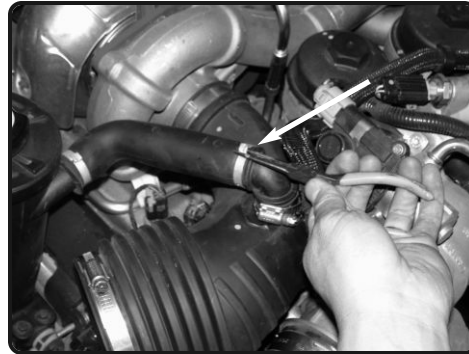

2. Use a needle nose plier and remove the permanent hose clamp on the factory air duct. A #16 clamp will be supplied to replace this clamp.

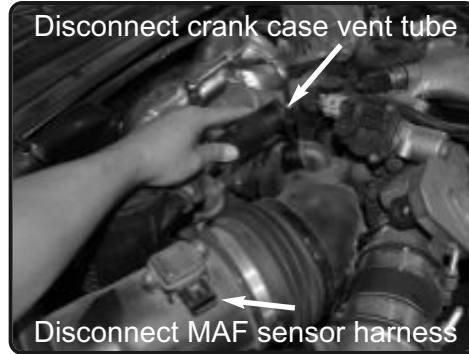

3. Disconnect the crank case vent tube from the factory air duct and MAF sensor harness from the MAF sensor on the air box assembly.



4. Loosen the two clamps on the factory air duct and then remove the entire factory air duct.



5. Unscrew the screws on the MAF sensor and then remove the MAF sensor from the factory air box assembly.

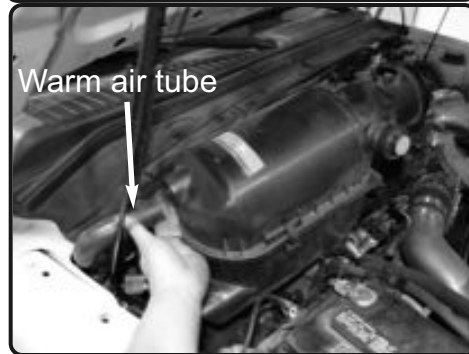

6. Detach the warm air tube from the factory air box assembly. Lift up firmly on the air box assembly and remove the air box assembly out of the engine bay.

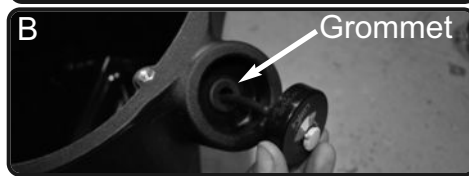
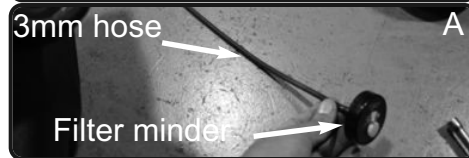

7. **Figure A:** Insert the 3mm hose onto the filter minder. **Figure B:** Insert the grommet into the minder pod on the Injen lower air box and then insert the 3mm vacuum line and filter minder into the grommet.



8. Place the filter onto the filter flange under the Injen air box plenum and then secure the clamp.



9. Connect the 3mm vacuum hose from the filter minder in figure 7 to the 1/8" fitting on the filter



10. Place the Injen intake plenum onto the top of the Injen lower air box.

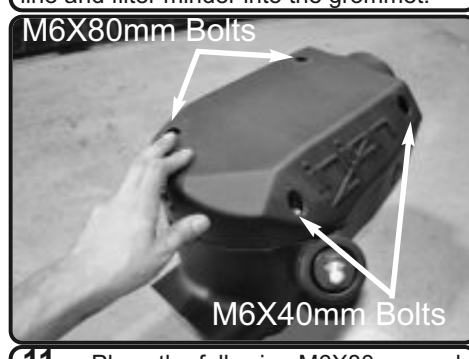

11. Place the following M6X80mm and M6X40mm bolts illustrated by the photo. Secure the bolts with a phillips head screw driver

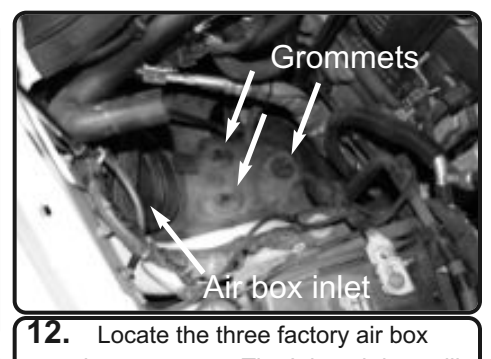

12. Locate the three factory air box mounting grommets. The Injen air box will also mount to these grommets. The air box inlet is also shown, which will insert into the Injen air box in the next step.



13. Drop the Injen air box assembly onto the three grommets from figure 12. Make sure the air box inlet inserts into the Injen lower inlet. Shifting the box left and down will help assist on securing the air box. The air box will not move once in place

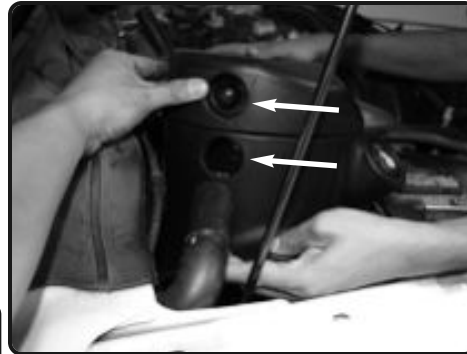

14. You can choose either port to connect the factory warm air tube. The open port is recommended for extremely cold weather.



15. Place the 3.0"- 4.0" step hose with #64 and #48 clamps onto the turbo inlet. Secure only the clamp on the turbo side for now.



16. Place the 4.50" hump hose and two #72 clamps onto the big end of the Injen intake tube. You will have to slip the entire hump hose over the tube to make room to install the tube onto the Injen air box.



17. Push the 3.0" end of the Injen tube into the 3.0"-4.0" step hose on the turbo. Then slide the 4.5" hump hose over to the Injen air box side.



18. Once the Injen intake tube is in position, secure all the clamps



19. Use the supplied #16 clamp and secure the crank case vent tube to the port on top of the Injen intake tube.

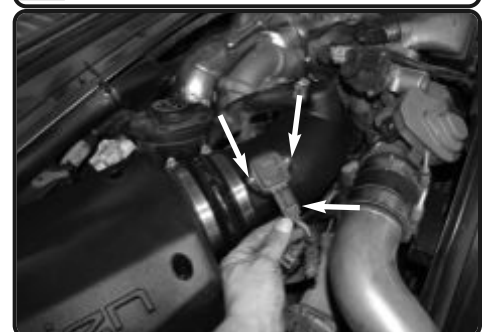

20. Use the supplied M4X10 bolts and secure the MAF sensor to the intake tube and then reconnect the MAF sensor harness



Congratulations! You have just completed the installation of this intake system. Periodically, check the alignment of the intake, normal wear and tear can cause nuts and bolts to come loose. Note: Check clearance and adjust if needed! Failure to check the alignment and adjust the intake can cause damage that will void the warranty. Injen Technology is not responsible for any damages caused by/from improper installation.

Test Drive:

1. With the transmission in neutral or park and the parking brake engaged, start the engine. Listen for air leaks or odd noises. If air leaks are detected, secure hoses and connections. For any odd noises, inspect entire system for cause and adjust intake as needed. The Injen intake will function identically to the factory system but will be louder and more powerful.
2. Perform a road test. Listen for odd noises or rattles and fix as necessary.
3. If there are no issues, continue to enjoy your added performance from the Injen performance Intake kit.
4. Injen Technology recommends you periodically check clearance and adjust if needed! Failure to check the alignment and adjust the intake can cause damage that will void the warranty. Injen Technology is not responsible for any damages caused by/from improper installation.

1. Upon completion of the installation, reconnect the negative battery terminal before you start the engine.
2. Align the entire intake system for the best possible fit. Once the intake has been properly fitted continue to tighten all nuts, bolts and clamps.
3. Periodically, recheck the alignment of the intake system and make sure there is proper clearance around and along the length of the intake. Failure to follow proper maintenance procedures may cause damage to the intake and will void the warranty.
4. Start the engine and listen carefully for any odd noises, rattles and/or air leaks prior to taking it for a test drive. If any problems arise go back and check the vacuum lines, hoses and clamps that maybe causing leaks or rattles and correct the problem.
5. Check the filter for excessive dirt build up.
Enjoy the added power and performance of your new intake system.