



Vehicle Applications:

Make: Cadillac
Model: Escalade, Escalade ESV
Year: 2015-17
Engine: 6.2L V8

Make: Chevrolet
Model: Silverado
Year: 2014-17
Engine: 5.3L/6.2L V8

Model: Tahoe
Year: 2015-2017
Engine: 5.3L V8

Model: Suburban
Year: 2015-17
Engine: 5.3L V8

Make: GMC
Model: Sierra
Year: 2014-16
Engine: 5.3L/6.2L V8

Model: Yukon, Yukon XL, Yukon Denali, Yukon Denali XL
Year: 2015-17
Engine: 5.3L, 6.2L V8

Optional Filter Monitor kit .
 Part # AC1000

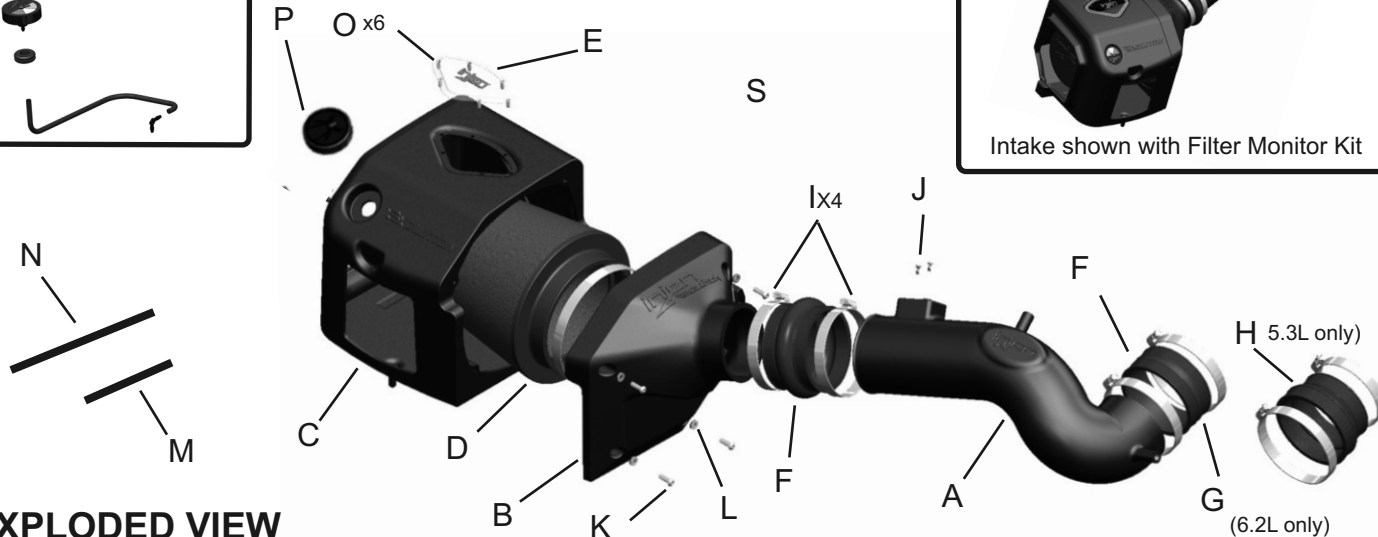

EXPLODED VIEW

Item	QTY.	P/N	Discription
A	1	#15110	Rotomold Tube
B	1	#15106	Rotomold Plenum
C	1	#15105	Rotomold Box
D	1	#1101	Dry Filter
E	1	#15122	ClearVue window
F	1	#3168	4" hump hose
G	1	#3129	4" straight hose (Used on 6.2L)
H	1	#3203	3.5"x4" step hose (Used on 5.3L)

I	4	#4008	#64 clamps
J	2	#6047	M4 button head screws
K	4	#6100	M6x20mm screws
L	4	#8047	Rubberized washers
M	1	#3079	15mm hose @8.5" Length
N	1	#3079	15mm hose @14.5" Length
O	6	#6109	Self retaining lock Washers
P	1	#6111	Filter Monitor Plug

TOOLS REQUIRED

- 10mm Ratchet & Socket
- 8mm nut drive
- Allen key
- Needle nose
- Phillips Screwdriver
- Pliers

Report any defective or missing parts to the authorized Injen dealer you purchased this product from. Before installing any parts of this system, please read the instructions thoroughly. If you have any questions regarding installation, please contact your Injen Technology dealer. Installation DOES require some mechanical skills. A qualified mechanic is always recommended.

A Limited Lifetime Warranty to the original purchaser against defects in material and workmanship on all Injen intake systems excluding the filter element. Any and all warranty coverage is limited to the repair or replacement of the defective part only, at Injen Technology's discretion. The warranty does not cover incidental or consequential damages, nor does it cover the cost of installation or removal of the defective part or its replacement. Proof of purchase is required.

Instruction Manual P/N:EVO7103

NOTE: This intake kit may not work on vehicles with the following aftermarket modifications.

- Aftermarket Intercooler piping
- Aftermarket intercooler
- Turbo upgrade

Injen intake systems are street legal in most states unless the state is adopting to California Emissions standards. States that have adopted California emission standards include: Arizona, California, Connecticut, District of Columbia, Maine, Maryland, Massachusetts, New Jersey, New Mexico, New York, Oregon, Pennsylvania, Rhode Island, Vermont, and Washington. These states will require an California Air Resource Board Executive Order Number (CARB E.O.) for the legal use of an Injen intake system in your vehicle for use on public roads or highways. These vehicle will be considered "Legal in California only for racing vehicles competition use only, which may never be used upon a public street or highway. **Please keep your factory air box assembly for any future use.**

The SuperNano-Web filter media is a dry synthetic media that outperforms the competition. The media itself is a proprietary base blend of synthetics and cellulose. Cellulose fibers are larger than synthetic fibers, and have larger spaces between the fibers, causing contaminants to load in the depth of the media and plug the airflow path. This creates higher restriction levels and less capacity. The synthetic fibers in the SuperNano-Web media are submicron in diameter and have small interior fiber spaces, which result in more contaminants being captured on the surface of the media. This can help keep restriction levels low as the filter loads with dirt and containments



If you look at the picture to the left, you can see the Nano-fiber web on top of our base media. That web, or Super-Nano-Web as we like to call it, helps trap smaller particles and protect your engine.

To Clean your filter:

Carefully remove the filter from the housing. Once removed, wipe down the housing using a clean shop towel, being careful not to knock any dirt and/or debris in the air inlet. Your filters can be cleaned by carefully vacuuming the filter media from the dirty side, or by holding the filter with one hand and carefully blowing the filter media at a 45-degree angle from the clean side using low-pressure shop air (15-20 lbs. psi).

***IT IS IMPORTANT TO NOT USE ANY CLEANERS ON THE SUPERNANO-WEB MEDIA OR APPLY ANY OIL!!!**

WARNING: FAILURE TO FOLLOW INSTALLATION INSTRUCTIONS AND NOT USING THE PROVIDED HARDWARE MAY DAMAGE THE INTAKE SYSTEM, ENGINE AND COMPONENTS!!!

***Do not attempt to install the intake system while the engine is hot.**
Severe burn could result from touching hot engine components!

NOTE: DISCONNECT BATTERY BEFORE INSTALLATION!!!

Optional: Filter Monitor Kit P/N: AC1000



Item	QTY.	P/N	Discription
A	1	15040	Filter Monitor Gauge
B	1	3198	3mm hose @ 15" Length
C	1	8026	Grommet
D	1	8057	5/32" 90 deg. Elbow Fitting

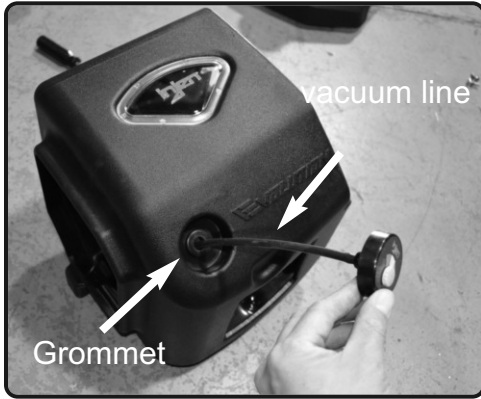
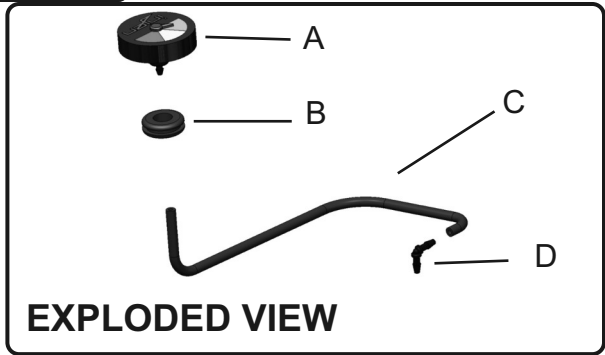

1. Connect the 3mm vacuum line to the Filter Monitor. Place the grommet into the 3/4" in the air box. Then run the 3mm vacuum line through the grommet.



2. Rotate the Filter Monitor as desired.



2. Drill a 0.1890" hole on top of the filter and firmly push the supplied 5/32 90 degree fitting into the hole.



3. Connect the 3 mm Vacuum line to the 5/32" fitting on the top of the filter.

- Optimize filter service intervals
- Stop over servicing
- Reduce under servicing
- Minimize unnecessary labor

Features:

Injen's Filter Monitor allows you to quickly inspect the filters performance by monitoring the restriction level of the filter. As dirt and debris builds up onto the filter media, a restriction is created causing a vacuum affect to pull the service indicator needle built into the Injen Filter Monitor. As the filter goes through its service, the service indicator needle will move from green, yellow and red depending on the filters condition. No need to remove the filter from the intake kit or engine bay to inspect the filter. Saving you wasteful time and money from unnecessary service and filter replacements.

Instruction Manual P/N:EVO7103



1. Stock intake system shown.



2. Unplug the the harness off the MAF sensor

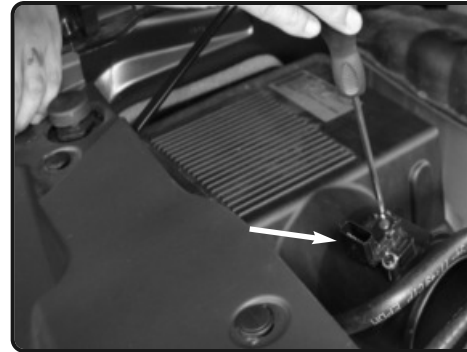

3. Use a T15 Torx bit and remove the two screws on the MAF sensor.



4. Pull the MAF sensor out of the factory air box assembly

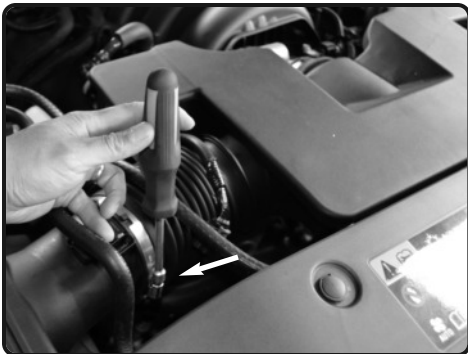

5. Loosen the clamp on the air box using 8mm nut driver.

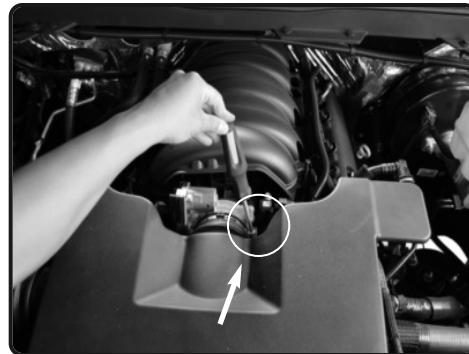

6. Loosen the clamp on the throttle body.

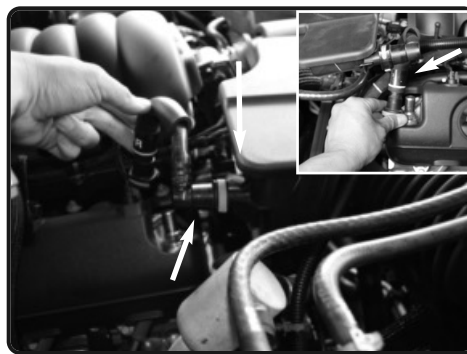

7. Disconnect both of the crank case lines from the air box and engine and remove the hard lines from vehicle.



8. You may now remove the entire air duct

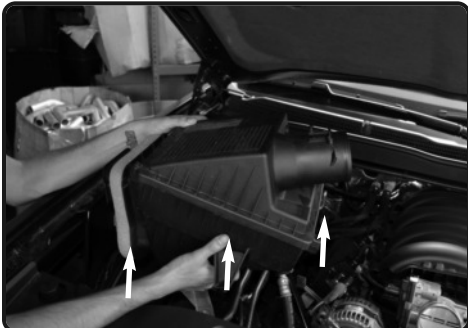

9. Remove the entire air box assembly



10. Remove the grommet spacer from the factory air box.



11. Now install the grommet spacer into the new injen air box and secure.



12. Push the Filter Monitor Plug into the Filter Monitor pod on the Injen air box if you are not using the Filter Monitor Kit P/N AC1000

Instruction Manual P/N:EVO7103

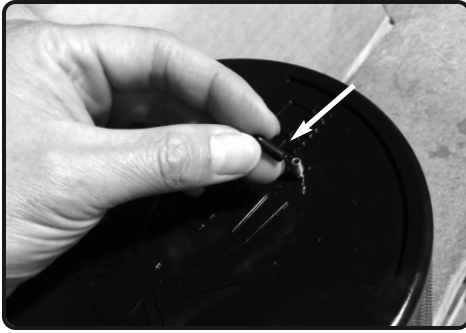

13. Place the 3mm vacuum cap on top of the Injen filter if you are not using the optional Filter Monitor Kit P/N AC1000

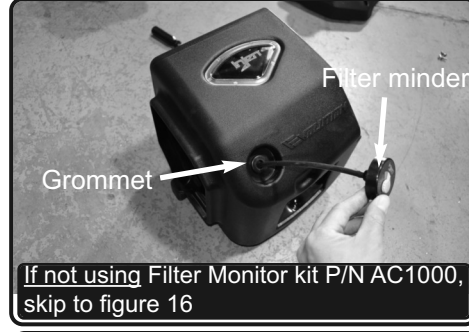

If not using Filter Monitor kit P/N AC1000, skip to figure 16

14. Install the provided grommet to the hole on air box, now attach the 3mm vacuum line to the filter minder and install the filter minder to the air box. Place hose through the grommet.



If not using Filter Monitor kit P/N AC1000, skip to figure 16

15. Attach the other end of the 3mm vacuum line to the filter fitting and secure.



16. Install the filter to the plenum, secure and tighten using 8mm nut driver.



18. Now secure the plenum using provided 4 M6 screws and rubberized washers. Secure and tighten.



17. Install the 3.5"x4" step hose with clamps to the intake tube. Install the 4" hump hose to the intake tube with clamps. **For 6.2L only, use provided 4" straight hose on throttle body.**

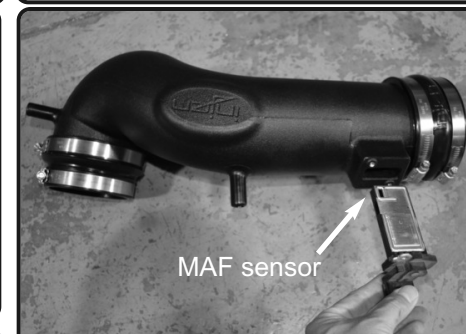

18. Install the MAF sensor into the intake tube and secure using provided M4 button head screws.

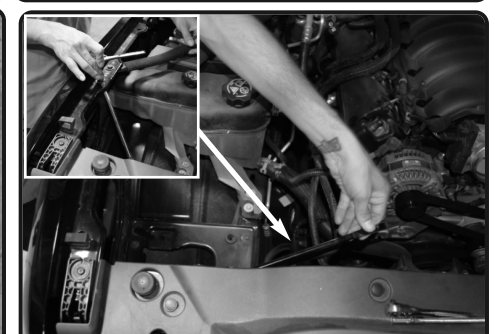

19. Loosen the support bar using 10mm socket or wrench. Push back for installation of air box.



20. Now install the air box assembly into the vehicle. Position the tabs to seat like OEM box.



21. Secure the air box, re-secure the support bar.

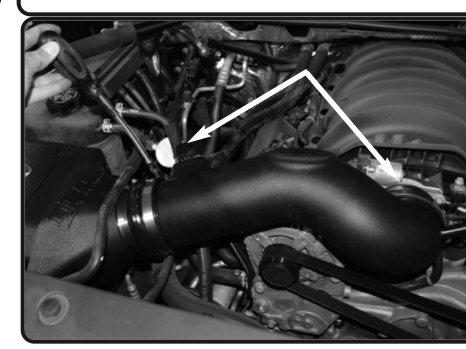

22. Install the intake tube. Secure the tube to airbox and throttle body. Position for best fit and tighten clamps. Re-connect the MAF sensor Harness.

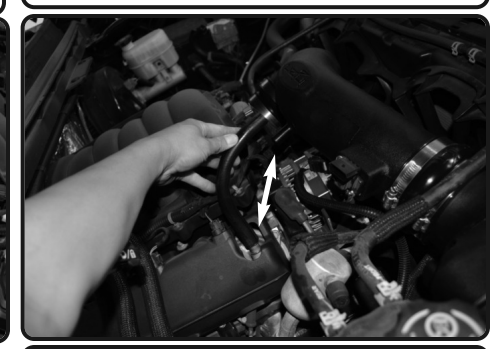

23. Install the provided 8.5" 15mm hose to the fitting on engine and intake tube on passenger side.



24. Install the provided 14.5" 15mm hose to the fitting on engine and intake tube on driver side.



Congratulations! You have just completed the installation of this intake system. Periodically, check the alignment of the intake, normal wear and tear can cause nuts and bolts to come loose. **Note: Check clearance and adjust if needed! Failure to check the alignment and adjust the intake can cause damage that will void the warranty. Injen Technology is not responsible for any damages caused by/from improper installation.**

Test Drive:

1. With the transmission in neutral or park and the parking brake engaged, start the engine. Listen for air leaks or odd noises. If air leaks are detected, secure hoses and connections. For any odd noises, inspect entire system for cause and adjust intake as needed. The Injen intake will function identically to the factory system but will be louder and more powerful.
2. Perform a road test. Listen for odd noises or rattles and fix as necessary.
3. If there are no issues, continue to enjoy your added performance from the Injen performance Intake kit.
4. Injen Technology recommends you periodically check clearance and adjust if needed! Failure to check the alignment and adjust the intake can cause damage that will void the warranty. Injen Technology is not responsible for any damages caused by/from improper installation.

1. Upon completion of the installation, reconnect the negative battery terminal before you start the engine.
 2. Align the entire intake system for the best possible fit. Once the intake has been properly fitted continue to tighten all nuts, bolts and clamps.
 3. Periodically, recheck the alignment of the intake system and make sure there is proper clearance around and along the length of the intake. Failure to follow proper maintenance procedures may cause damage to the intake and will void the warranty.
 4. Start the engine and listen carefully for any odd noises, rattles and/or air leaks prior to taking it for a test drive. If any problems arise go back and check the vacuum lines, hoses and clamps that maybe causing leaks or rattles and correct the problem.
 5. Check the filter for excessive dirt build up. Clean or replace the filter with an original Injen filter.
- Congratulations! You have just completed the installation of the best intake system sold on the market. Enjoy the added power and performance of your new intake system.