

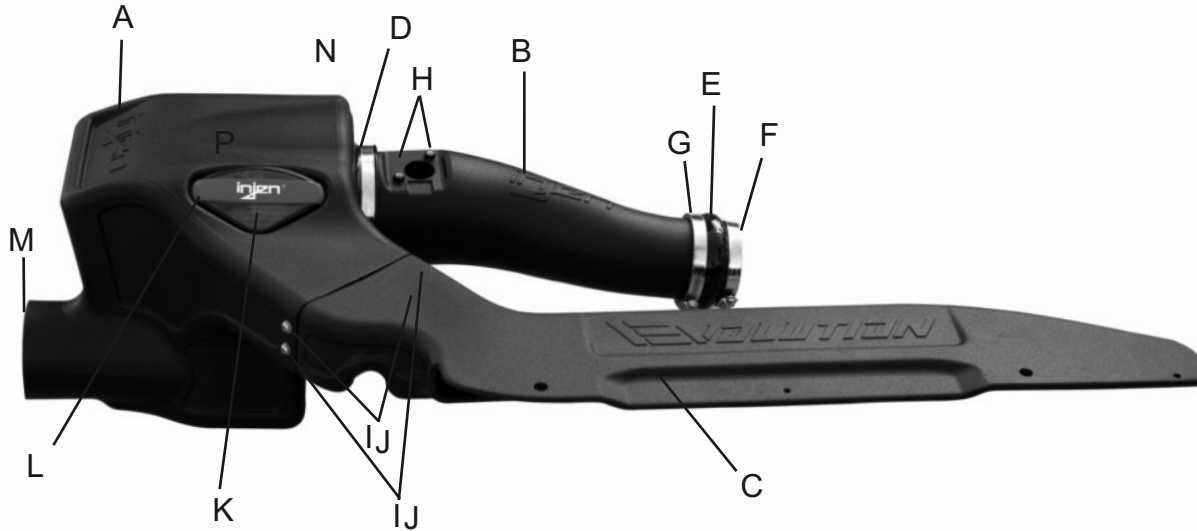

Vehicle Application:			
Make: <b>Toyota</b>			
Model: <b>Tacoma</b>			
Year: <b>2016-18</b>			
Engine: <b>3.5L V6</b>			



Item	QTY.	P/N	Discription
A	1	X-15149	Air box
B	1	X-15151	Tube
C	1	X-15150	Scoop
D	1	X-1107BB	Dry filter (Blue Media) <sup>EVO2200</sup>
D	1	X-1107BR	Oiled Filter (Red Media) <sup>EVO2200C</sup>
E	1	X-3236	3.5x3.125 step hump hose
F	1	X-4004	#48 clamp
G	1	X-4005	#56 clamp
H	2	X-6047	M4 screws
I	4	X-6073	M6 button head screws
J	4	X-8047	Rubber washers
K	1	X-15139	Small window
L	2	X-6109	push washers
M	1	X-6113	Thick rubber trim @ 12.5"L

TOOLS REQUIRED	
<ul style="list-style-type: none"> <li>• 10mm Ratchet &amp; Socket</li> <li>• 8mm nut drive</li> <li>• 2.5mm Allen key</li> <li>• Flat Blade Screwdriver</li> <li>• Phillips Screwdriver</li> <li>• Pliers/cutters</li> </ul>	

**WARNING:** FAILURE TO FOLLOW INSTALLATION INSTRUCTIONS AND NOT USING THE PROVIDED HARDWARE MAY DAMAGE THE INTAKE SYSTEM, ENGINE AND COMPONENTS!!!  
**\*Do not attempt to install the intake system while the engine is hot.**  
 Severe burn could result from touching hot engine components!

Report any defective or missing parts to the authorized Injen dealer you purchased this product from. Before installing any parts of this system, please read the instructions thoroughly. If you have any questions regarding installation, please contact your Injen Technology dealer. Installation DOES require some mechanical skills. A qualified mechanic is always recommended.

A Limited Lifetime Warranty to the original purchaser against defects in material and workmanship on all Injen intake systems excluding the filter element. Any and all warranty coverage is limited to the repair or replacement of the defective part only, at Injen Technology's discretion. The warranty does not cover incidental or consequential damages, nor does it cover the cost of installation or removal of the defective part or its replacement. Proof of purchase is required.

# Instruction Manual P/N:EVO2200

Injen intake systems are street legal in most states unless the state is adopting to California Emissions standards. States that have adopted California emission standards include: Arizona, California, Connecticut, District of Columbia, Maine, Maryland, Massachusetts, New Jersey, New Mexico, New York, Oregon, Pennsylvania, Rhode Island, Vermont, and Washington. These states will require an California Air Resource Board Executive Order Number (CARB E.O.) for the legal use of an Injen intake system in your vehicle for use on public roads or highways. These vehicle will be considered "Legal in California only for racing vehicles competition use only, which may never be used upon a public street or highway. **Please keep your factory air box assembly for any future use.**

***NOTE: Verify your filter before any cleaning maintenance!***

***Blue media filter: Dry Air Filter, no oil required.***

*(SuperNano Web Dry filters require no oil, these can be cleaned using a vacuum or light compressed air. Please do not clean using water or injen restore kit. )*

***Red media filter: Factory Oiled Air Filter.***

*(Oiled cotton gauze filters require oil, please use injen restore kit. This filter can use water or cleaning solution for maintenance. )*



***NOTE: DISCONNECT BATTERY BEFORE INSTALLATION!!!***

# Instruction Manual P/N:EVO2200

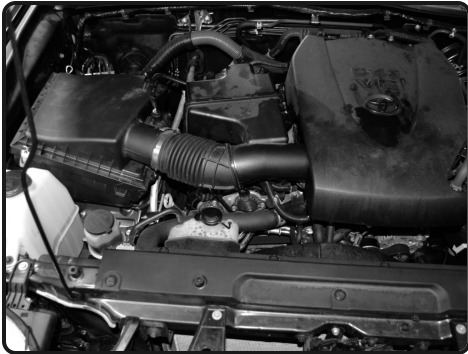

**1.** Stock intake system shown. Lift up engine cover and remove.

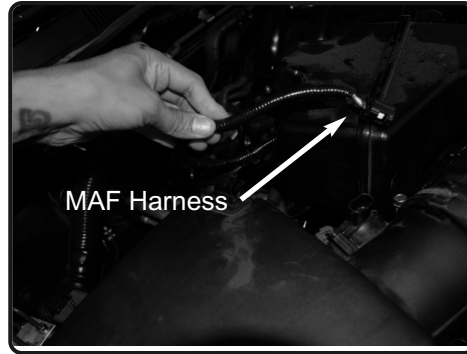

**2.** Disconnect the MAF sensor harness and pull line away harness from the airbox.

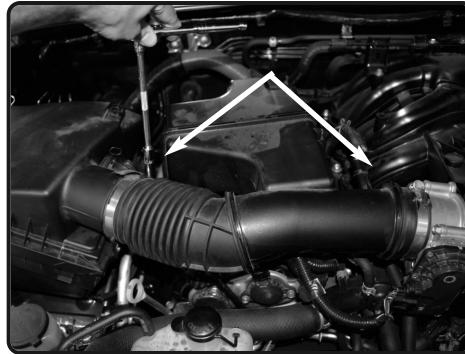

**7.** With 10mm nut driver or socket with ratchet, loosen the clamps on throttle body and airbox.

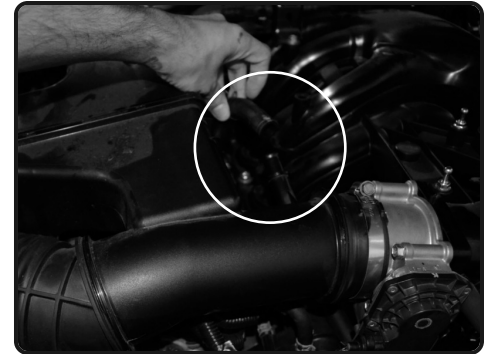

**3.** Now disconnect the Crank case fitting from the intake tube and pull back from tube.



**4.** Un-clip upper half of airbox and remove from vehicle.



**5.** Now lift up and remove the stock intake tube from the vehicle.

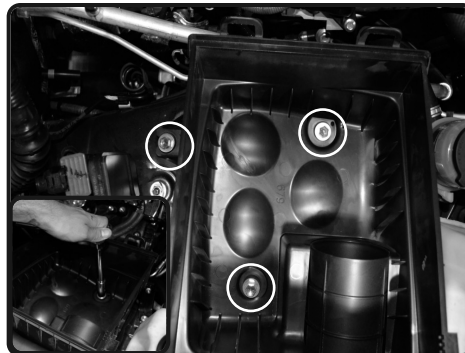

**6.** Loosen the 3 bolts holding in the lower part of the airbox.



**7.** Now lift up and remove the lower part of the airbox out of vehicle.



**8.** With phillips screwdriver, loosen the 2 screws holding in the MAF sensor. Carefully remove the MAF sensor.



**9.** Install the MAF sensor into the intake tube, secure using provided M4 button head screws.

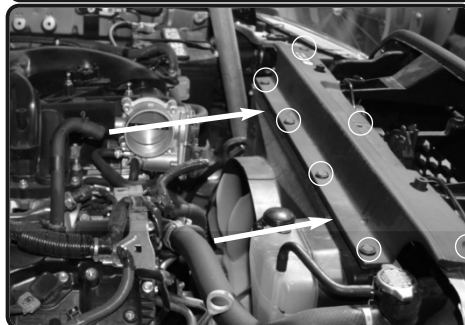

**10.** Loosen and remove the 7 push clips holding in the radiator plastic shroud and remove. Save 2 push clips for later install.

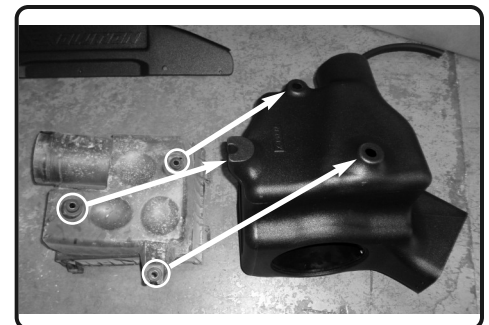

**11.** Remove the 3 grommet with crush-washer and install into the new air box.



**12.** Make sure the grommets are seated and secured.



**13.** Install the rubber trim to the air box hole. Install the scoop to the air box.

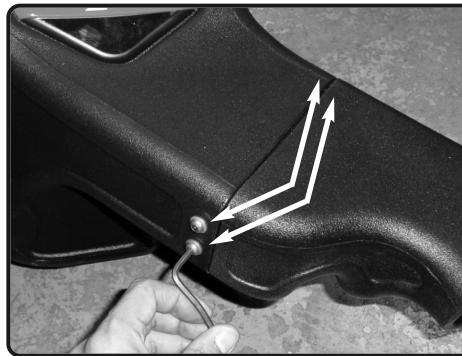

**14.** Secure the scoop to box using provided M6 button head screws and rubber washers. Secure and tighten using allen key.



**15.** Install the air box assembly into the vehicle and position.

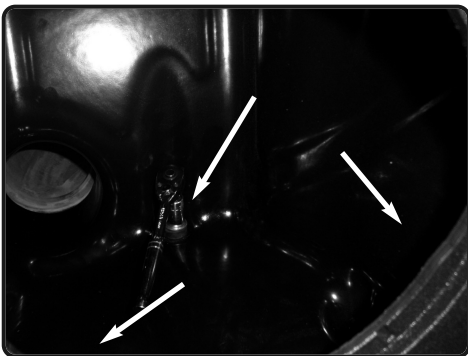

**16.** Secure the OEM airbox to the original airbox position. Secure and tighten using OEM M8 screws.

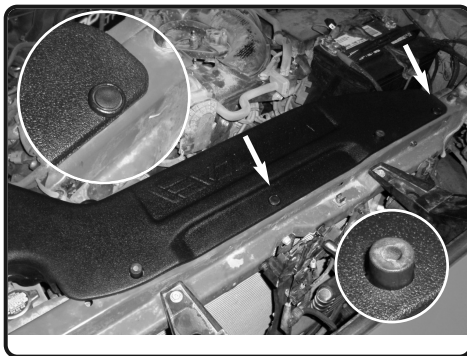

**17.** Position the scoop and make sure the smaller holes are used for the 2 push clips from step 10. The 2 hood bushings will go through the scoop.



**18.** Insert twist lock filter to the air box.



**19.** Once seated, rotate in either direction 1/4 turn till filter locks.

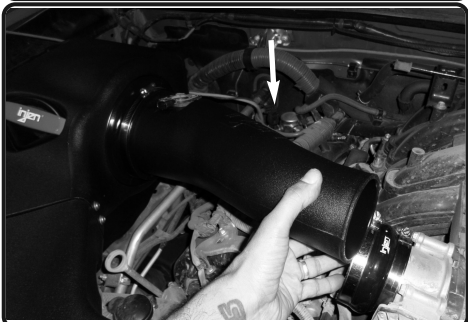

**20.** Install step hump hose to the throttle body. Install the intake tube to the vehicle and position.



**21.** Connect the MAF sensor harness.



**22.** Re-connect the crank case line to the injen intake tube.



**23.** Tighten all clamps using 8mm ut driver. Re-install the engine cover.



Congratulations! You have just completed the installation of this intake system. Periodically, check the alignment of the intake, normal wear and tear can cause nuts and bolts to come loose. **Note: Check clearance and adjust if needed! Failure to check the alignment and adjust the intake can cause damage that will void the warranty. Injen Technology is not responsible for any damages caused by/from improper installation.**

## Test Drive:

1. With the transmission in neutral or park and the parking brake engaged, start the engine. Listen for air leaks or odd noises. If air leaks are detected, secure hoses and connections. For any odd noises, inspect entire system for cause and adjust intake as needed. The Injen intake will function identically to the factory system but will be louder and more powerful.
2. Perform a road test. Listen for odd noises or rattles and fix as necessary.
3. If there are no issues, continue to enjoy your added performance from the Injen performance Intake kit.
4. Injen Technology recommends you periodically check clearance and adjust if needed! Failure to check the alignment and adjust the intake can cause damage that will void the warranty. Injen Technology is not responsible for any damages caused by/from improper installation.

1. Upon completion of the installation, reconnect the negative battery terminal before you start the engine.
2. Align the entire intake system for the best possible fit. Once the intake has been properly fitted continue to tighten all nuts, bolts and clamps.
3. Periodically, recheck the alignment of the intake system and make sure there is proper clearance around and along the length of the intake. Failure to follow proper maintenance procedures may cause damage to the intake and will void the warranty.
4. Start the engine and listen carefully for any odd noises, rattles and/or air leaks prior to taking it for a test drive. If any problems arise go back and check the vacuum lines, hoses and clamps that maybe causing leaks or rattles and correct the problem.
5. Check the filter for excessive dirt build up. Clean or replace the filter with an original Injen filter. Congratulations! You have just completed the installation of the best intake system sold on the market. Enjoy the added power and performance of your new intake system.