



Vehicle Application:

Make: **Honda**
 Model: **Type R (FK8)**

Year: **2017-18**
 Engine: **2.0L 4-cyl. Turbo**



Item	QTY.	P/N	Discription
A	1	15159	Air box
B	1	15160	Intake Tube
C	1	1112	Twist Lock Air filter
D	1	3234	step hump hose w/ fitting
E	1	4004	#48 clamp
F	1	4005	#56 clamp
G	1	15139	small injen window
H	2	6109	lock washer

- TOOLS REQUIRED**
- 10mm Ratchet & Socket
 - 8mm nut drive
 - Allen key
 - Flat Blade Screwdriver
 - Philllips Screwdriver

WARNING: FAILURE TO FOLLOW INSTALLATION INSTRUCTIONS AND NOT USING THE PROVIDED HARDWARE MAY DAMAGE THE INTAKE SYSTEM, ENGINE AND COMPONENTS!!!

***Do not attempt to install the intake system while the engine is hot.**
 Severe burn could result from touching hot engine components!

Report any defective or missing parts to the authorized Injen dealer you purchased this product from. Before installing any parts of this system, please read the instructions thoroughly. If you have any questions regarding installation, please contact your Injen Technology dealer. Installation DOES require some mechanical skills. A qualified mechanic is always recommended.

A Limited Lifetime Warranty to the original purchaser against defects in material and workmanship on all Injen intake systems excluding the filter element. Any and all warranty coverage is limited to the repair or replacement of the defective part only, at Injen Technology's discretion. The warranty does not cover incidental or consequential damages, nor does it cover the cost of installation or removal of the defective part or its replacement. Proof of purchase is required.

Instruction Manual P/N:EVO1502

NOTE: This intake kit may not work on vehicles with the following aftermarket modifications.

- Aftermarket Intercooler piping
- Aftermarket intercooler
- Turbo upgrade
- Modified body panels
- Suspension & Chassis modifications

Injen intake systems are street legal in most states unless the state is adopting to California Emissions standards. States that have adopted California emission standards include: Arizona, California, Connecticut, District of Columbia, Maine, Maryland, Massachusetts, New Jersey, New Mexico, New York, Oregon, Pennsylvania, Rhode Island, Vermont, and Washington. These states will require an California Air Resource Board Executive Order Number (CARB E.O.) for the legal use of an Injen intake system in your vehicle for use on public roads or highways. These vehicle will be considered "Legal in California only for racing vehicles competition use only, which may never be used upon a public street or highway. **Please keep your factory air box assembly for any future use.**



The SuperNano-Web filter media is a dry synthetic media that outperforms the competition. The media itself is a proprietary base blend of synthetics and cellulose. Cellulose fibers are larger than synthetic fibers, and have larger spaces between the fibers, causing contaminants to load in the depth of the media and plug the airflow path. This creates higher restriction levels and less capacity. The synthetic fibers in the SuperNano-Web media are submicron in diameter and have small interior fiber spaces, which result in more contaminants being captured on the surface of the media. This can help keep restriction levels low as the filter loads with dirt and containments

If you look at the picture to the left, you can see the Nano-fiber web on top of our base media. That web, or SuperNano-Web as we like to call it, helps trap smaller particles and protect your engine.

To Clean your filter:

Carefully remove the filter from the housing. Once removed, wipe down the housing using a clean shop towel, being careful not to knock any dirt and/or debris in the air inlet. Your filters can be cleaned by carefully vacuuming the filter media from the dirty side, or by holding the filter with one hand and carefully blowing the filter media at a 45-degree angle from the clean side using low-pressure shop air (15-20 lbs. psi).

****IT IS IMPORTANT TO NOT USE ANY CLEANERS ON THE SUPERNANO-WEB MEDIA OR APPLY ANY OIL!!!***

NOTE: DISCONNECT BATTERY BEFORE INSTALLATION!!! MAKE SURE VEHICLE IS COOL BEFORE INSTALLATION, COOLANT LINE WILL BE REMOVED.

Instruction Manual P/N:EVO1502



1. Stock intake system shown.



2. Loosen the 2 bolts holding in the OEM rubber Ram scoop.

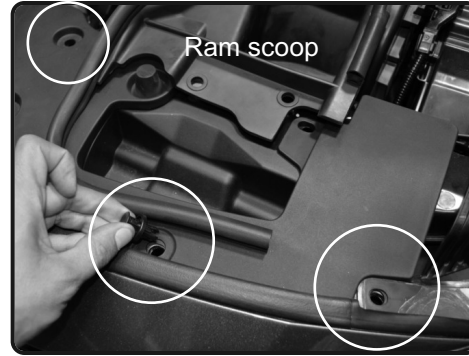

3. Carefully remove the push-clips from the upper engine cover.

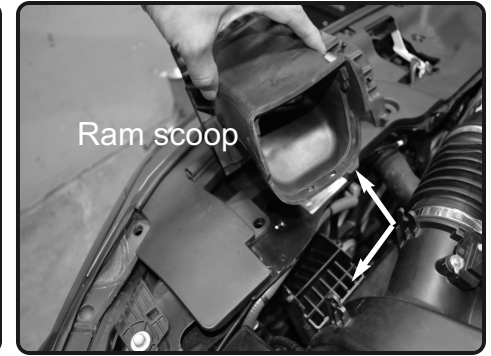

4. Now lift up and pull back the Rubber ram scoop. Note: there are plastic fittings holding in scoop, pull rubber away from fittings.

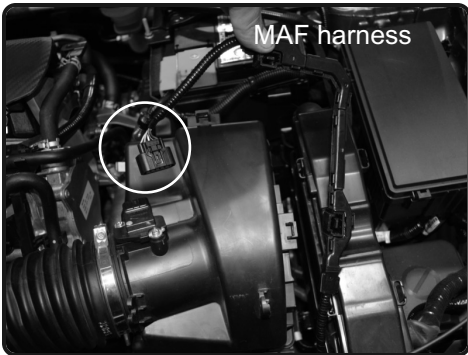

5. Disconnect the MAF sensor harness. Pull back the line away from the airbox.

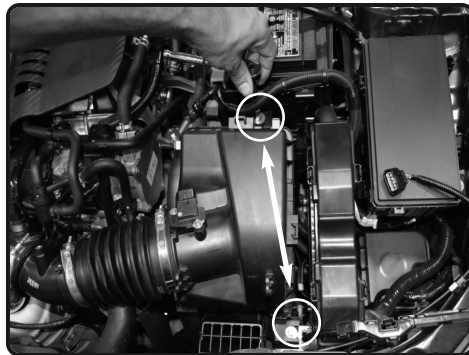

6. Loosen the two 10mm bolts holding in the stock air box. Save for later install.

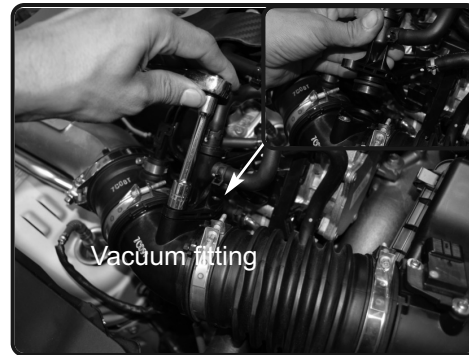

7. With 10mm socket, remove the 2 screws holding in vacuum fitting. Carefully pull back fitting.



8. Loosen the clamp on turbo using phillips screwdriver.

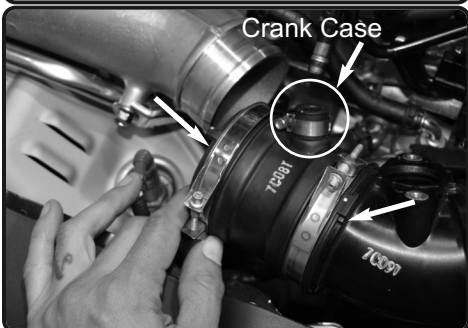

9. Now pull back the intake tube from turbo. Brake the crank case clamp using pliers to remove. Remove the crank case hardline out of intake tube.



10. Lift up and remove the airbox.

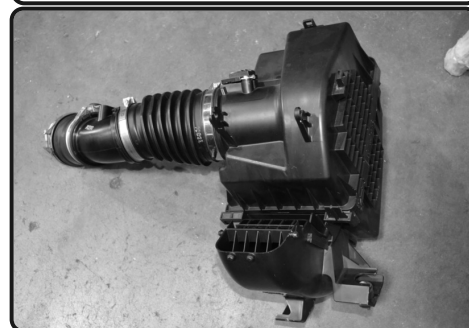

11. Complete stock air box removed.



12. Remove the plastic push clips and remove the plastic radiator shroud.

Instruction Manual P/N:EVO1502

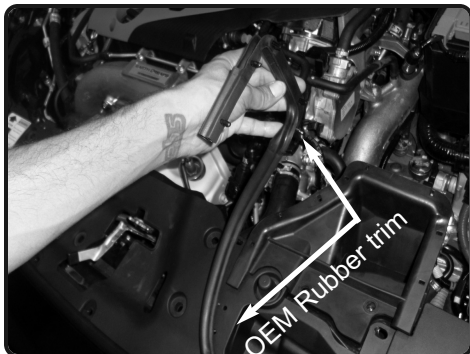

13. Remove the OEM rubber trim from the scoop using pliers. carefully pull out the clips holding in the rubber trim.



14. Complete OEM rubber trim removed. Remove the scoop.



15. Install the OEM rubber trim to the injen EVO air box.



16. Secure and snap in to place.



17. Remove the 2 smaller OEM grommets with crush washer from the OEM air box and install to the mounting points on injen EVO box.

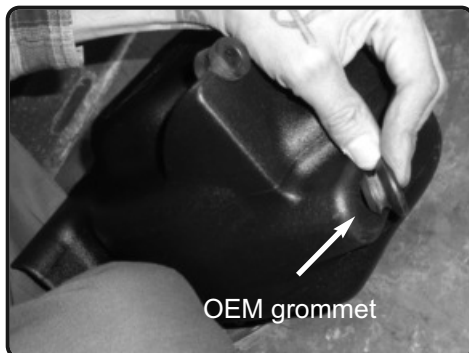

18. Remove the larger OEM grommet and install to the hole on the bottom of the air box.



19. Install the injen EVO air box assembly into the vehicle. Position to the OEM air box locations.



20. Once seated properly use the OEM screws from step 6, and secure the air box.



21. Install the injen twist lock filter into the air box.



22. Once the twist lock filter is seated correctly rotate in either direction 1/4" turn until filter locks into place.

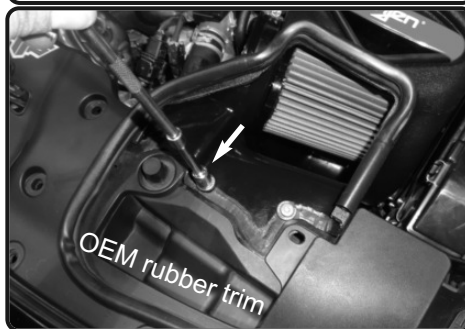

23. Re-install shroud, secure the front of the air box to the vehicle using originals screws from step 2. install the remaining rubber trim to the shroud.



24. Install the step hump hose with clamps provided to the throttle body and position. Do not tighten.

Instruction Manual P/N:EVO1502

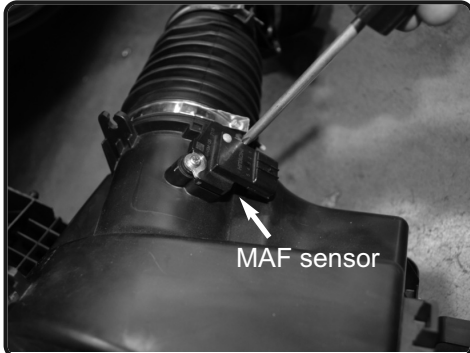

25. Loosen and remove the MAF sensor from the air box.

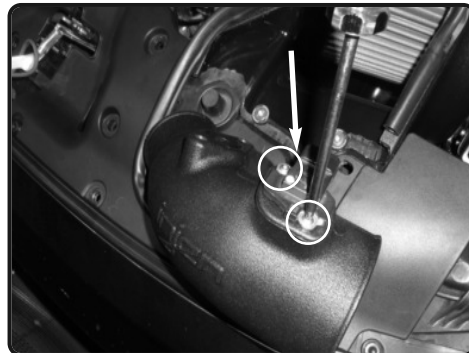

26. Now install to the new injen intake tube and secure using original screws. Secure and tighten.

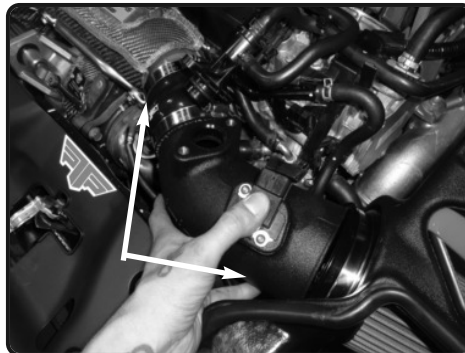

27. Install the intake tube into the vehicle and position the tube to the hose and filter.

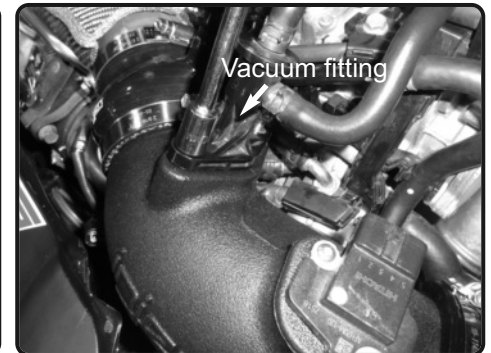

28. Install the vacuum fitting to the intake tube using the 2 original screws from step 7. Secure and tighten.



29. Re-connect the MAF sensor harness. Secure and tighten.

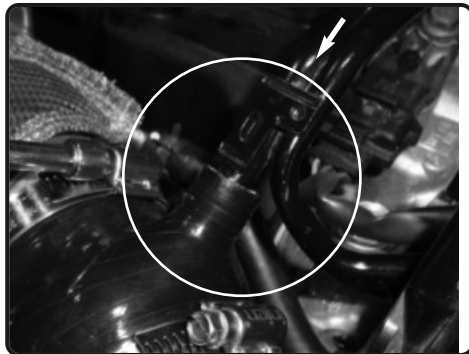

30. Install the crank case hardline from step 9 to the step hump hose.

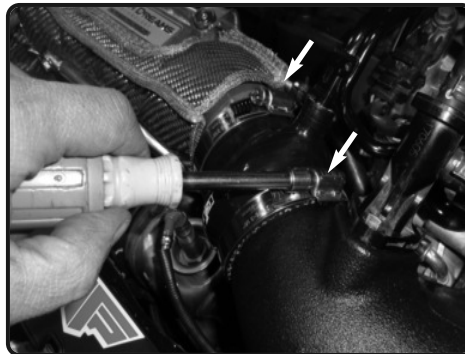

31. Adjust intake tube for proper fitment, secure and tighten all clamps.



Congratulations! You have just completed the installation of this intake system. Periodically, check the alignment of the intake, normal wear and tear can cause nuts and bolts to come loose. **Note: Check clearance and adjust if needed! Failure to check the alignment and adjust the intake can cause damage that will void the warranty. Injen Technology is not responsible for any damages caused by/from improper installation.**

Test Drive:

1. With the transmission in neutral or park and the parking brake engaged, start the engine. Listen for air leaks or odd noises. If air leaks are detected, secure hoses and connections. For any odd noises, inspect entire system for cause and adjust intake as needed. The Injen intake will function identically to the factory system but will be louder and more powerful.
2. Perform a road test. Listen for odd noises or rattles and fix as necessary.
3. If there are no issues, continue to enjoy your added performance from the Injen performance Intake kit.
4. Injen Technology recommends you periodically check clearance and adjust if needed! Failure to check the alignment and adjust the intake can cause damage that will void the warranty. Injen Technology is not responsible for any damages caused by/from improper installation.

1. Upon completion of the installation, reconnect the negative battery terminal before you start the engine.
2. Align the entire intake system for the best possible fit. Once the intake has been properly fitted continue to tighten all nuts, bolts and clamps.
3. Periodically, recheck the alignment of the intake system and make sure there is proper clearance around and along the length of the intake. Failure to follow proper maintenance procedures may cause damage to the intake and will void the warranty.
4. Start the engine and listen carefully for any odd noises, rattles and/or air leaks prior to taking it for a test drive. If any problems arise go back and check the vacuum lines, hoses and clamps that maybe causing leaks or rattles and correct the problem.
5. Check the filter for excessive dirt build up. Clean or replace the filter with an original Injen filter. Congratulations! You have just completed the installation of the best intake system sold on the market. Enjoy the added power and performance of your new intake system.