



CHARGER

IMPACT

 **IMPACT**TM
2016 CATALOG

TABLE of CONTENTS

HELMETS	1
CARBON FIBER HELMETS	3
COMPOSITE HELMETS	10
JUNIOR MINI-HELMETS	18
CREW HELMETS	19
HELMET ACCESSORIES	22
FRONTAL HEAD RESTRAINTS	25
IMPACT REV	25
IMPACT ACCEL	26
DRIVER SUITS	28
SUIT INFO & SIZING CHARTS	28
CUSTOM SUITS - SFI/FIA 2 & 3 LAYER	30
CUSTOM DRAG SUITS	32
OFF THE SHELF SUITS	34
CREW & TRACK WORKER SUITS	38
ARAMID UNDERWEAR	40
DYE-SUB CREW SHIRTS	42
GLOVES	44
FOOTWEAR	46
RESTRAINT SYSTEMS	47
RESTRAINT INFO	47
CUSTOMER FAVORITE RESTRAINTS	49
PRO SERIES SYSTEMS	50
RACER SERIES SYSTEMS	52
RESTRAINT ACCESSORIES	53
WINDOW NETS	54
TIE-DOWNS	55
DRAG CHUTES	56
STORAGE	58

ABOUT IMPACT

Impact is more than just a business. It is my life and my passion. There are a handful of companies involved in motorsports safety, but what sets Impact apart is that I am a racer. When I strap into my race truck and set out to conquer 500 grueling miles of unknown Baja terrain, one thing I do know for certain is I can count on my safety equipment. Many of my fellow race competitors are personal friends and I have enjoyed celebrating their wins and losses and life's milestones along the way. I take pride in knowing that my company, my products, and my dedicated Impact staff are a small part in returning my friends and fellow competitors home to their families after both the good and bad days at the track.

At Impact, we are a company that takes what we do to heart. We aren't just a website and email address. We are the faces you see at many of the events; from the heart of motorsports in Indy and Charlotte to the Chili Bowl and Baja. We proudly support and advance the safety of our men and women in the armed forces and also thousands of racers in all complements of motorsports with our innovative products made right here in the USA.

- Yours in Safety,



Robbie Pierce, MasterCraft® Safety and Impact Racing CEO

Motorsports is an inherently dangerous activity! Death, paralysis, or other personal injury may result while you are engaged in motorsports. No product can completely protect against all possible risks and the wearer assumes all risk for potential injury and death while participating in motorsports and racing activities. No warranty or representation is made to the product's ability to protect the user from injury or death. As the user, you are responsible for your own actions and decisions. It is the user's responsibility to become familiar with all available information concerning the correct use and limitations of all products prior to participating in motorsports activities.

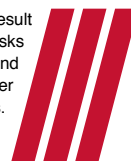

Helmets are one of the oldest pieces of personal armor. They have been cobbled from a variety of materials, ranging initially from leather and bronze and later evolving into elaborate creations in iron and brass as mankind advanced and discovered more sophisticated metals. Whether valiantly marching into battle, fearlessly racing chariots, or proudly jousting to earn fame and glory in the royal court, helmets have been used for thousands of years and for hundreds of different reasons. Helmets eventually emerged as a symbol of status and in keeping with heraldic tradition the helmet was often included in coats of arms with the adornment and style reflecting the status and rank of the bearer.

Fortunately, the 'armoring' used in the construction of modern helmets has greatly advanced, and just as material technology evolved upon the arrival of the Iron Age, today's motorsports helmets are a drastic departure in materials and design from what was found on many of the driver's just a few decades ago. Unlike days of the past, modern helmet design has more to do with the science of impact and energy attenuation than it does with the status and rank of the bearer. Whether you are a grassroots racer with a limited budget looking at our 1320 helmet, or a championship winning driver with unlimited funds running our Carbon Fiber Air Draft, all of our helmets meet and exceed our stringent performance characteristics.

So why are there such drastic differences in helmet pricing if all helmets feature similar performance characteristics?

In high-performance racing, it is no secret that reducing weight increases horsepower but requires the use of more expensive and exotic materials. Your helmet is no different. By using more expensive and lighter weight materials such as carbon fiber and blends of Kevlar® with carbon fiber and other composites, Impact can meet and increase the performance characteristics of a helmet's shell and its ability to attenuate energy at substantially less weight. A lighter weight helmet provides an increase in comfort while minimizing fatigue and offering the driver the opportunity to improve overall performance.

Look for our exclusive icons below for an easy reference helmet material guide:



Look for our exclusive icons below for a guide to the specific air system each helmet is designed for:

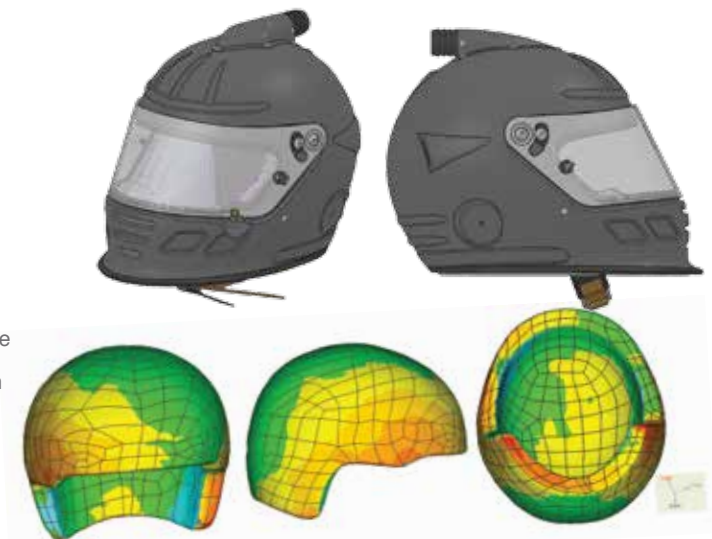

GRAY MATTER™
HELMET LINER MATERIAL

Every Impact helmet features our exclusive *Intelligent Gray Matter*, a variable-density, single piece inner liner covered with our soft-knit Nomex® material for the ultimate in impact and fire protection.



Silver Flat Black White Gloss Black

CHOOSE YOUR COLOR

Most helmet models are available in these four colors. *does not include the 1320 Side Air/Top Air and Autograph Helmets.



SA2015 HELMETS ARE HERE

The Snell Memorial Foundation, Inc. is a not-for-profit organization dedicated to research, education, testing and development of helmet safety standards. Since its founding in 1957, Snell has been a leader in helmet safety in the United States and around the world.



COVER PHOTO: DON SCHUMACHER RACING DRIVER, AND 2-TIME NHRA CHAMPION, FAST JACK BECKMAN. (Photos by Mark Rebilias)



ADULT HELMET SIZING

Vapor, Draft, Charger, Champ, RallyX, 1320, Nitro, Fueler and Crew models.

Impact Size:	Extra Small	Small	Medium	Large	Extra Large	2X
Hat Size:	6 3/4 to 6 7/8	6 7/8 to 7	7 1/8 to 7 1/4	7 3/8 to 7 1/2	7 5/8 to 7 3/4	7 7/8 to 8
Inch Size:	20 5/8 to 21	21 5/8 to 22	22 1/2 to 22 3/4	23 1/4 to 23 5/8	24 to 24 1/2	25 to 25 3/8

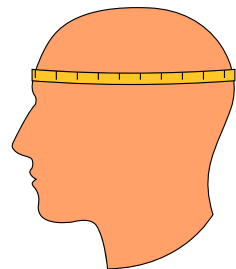

MINI-HELMET SIZING

Mini-Vapor, Mini-Champ, and Mini-Air Draft OS20

Impact Size:	Small - Two Inserts	Medium - One Insert	Large - No Inserts
Hat Size:	6 1/8 to 6 1/4	6 3/8 to 6 1/2	6 5/8 to 6 3/4
Inch Size:	19 to 19 1/4	19 1/2 to 20	20 1/2 to 21

HELMET FIT GUIDE

Measure Directly Above the Brow Line for Most Accurate Fit

Whether you are a driver or crew member, a helmet is your first line of personal defense. Accidents can happen on pit road just as quickly and easily as they do on the track. A well-fit helmet should not be too tight or too loose, however it should offer a comfortable, yet snug, fit with an even amount of pressure around the forehead and cheeks.

The most important area to ensure fits correctly and comfortably is around the forehead just above the brow line. If this area fits well, Impact can customize the cheek area with our line of interchangeable cheek pads. We offer cheek pads in varying widths from thin to thick, as well as V-style ear cut outs for radio earbuds. Keep in mind that helmets "break in" from use and may become larger. Make sure to select a helmet that is as snug as can be comfortably tolerated and cannot be moved around on the head in any direction once fastened.

You'll never know how a driver feels when he wins a race. The helmet hides the unfathomable emotions.

-Aryton Senna



IMPACT WILL COORDINATE WITH YOUR HELMET PAINTER

Once painted, we will complete the interior build out and install the communication systems and Frontal Head Restraint clips of your choice!

AIR DRAFT OS20™

CARBON FIBER - 20 DEGREE OFFSET AIR INTAKE

As dirt and off-road racers ourselves, we understand the importance of a helmet that fits and performs in the most extreme environments. Manufactured from our lightest weight carbon fiber material, the Impact Carbon Fiber Air Draft OS20™ offers improved driver comfort and reduced fatigue and neck strain thanks to its lightweight design. The off-centered and left positioned air inlet offers added overhead clearance in the cockpit while the air port is angled 20 degrees to provide ease of movement with the fresh air hose. Cooling comfort and fresh air is pumped through three individual air channels routed to direct air onto the visor further reducing fog and contaminants from interfering with the visual field. The unique placement of the air channels also eliminates the fresh air system from "opening" the microphone and interfering with the communication system. Featuring a wide eye port, the Air Draft OS20™ offers an exceptional range of peripheral vision while the wicker bill design provides aerodynamic down-force to reduce the potential of the helmet "lifting" at high speeds. Additional features such as a built-in chin deflector and the Nomex® covered eye port gasket practically eliminate dust and contaminants from entering the interior of the helmet while offering added thermal protection. Variable-density interchangeable cheek pads and a variety of anti-fog and tinted shields make this helmet truly customizable for a perfect fit. Manufactured from Impact's "Intelligent Gray Matter" inner liner and upholstered with soft-knit fire-retardant Nomex® fabrics, the Carbon Fiber Air Draft OS20™ is the helmet of choice for Impact owner, Robbie Pierce, during his treacherous Baja racing adventures.

Adult Sizes: XS/S/M/L/XL



FORCED AIR INTAKE SYSTEM

SIZE	CARBON FIBER
EXTRA SMALL	19915220
SMALL	19915320
MEDIUM	19915420
LARGE	19915520
EXTRA LARGE	19915620



CJ GREAVES BLASTS HIS PRO2 TRUCK THROUGH THE DIRT AT CHICAGO IN THE TORC SERIES.

TRAVIS PASTRANA TRUSTS IMPACT HELMETS FOR HIS GLOBAL RALLY CROSS EVENTS AS WELL AS HIS BITO MINT 400 RUNS.





AIR DRAFT™
CARBON FIBER - TOP AIR INTAKE

Impact's Carbon Fiber Air Draft is the helmet of choice for professional racers such as Boris Said and Robby Gordon! Utilizing a low-profile version of our popular Venturi Cowl air induction system, the Impact Air Draft will keep you cool, clean and fog-free all race long. Clean air is circulated through three "whisper" channels and directed onto the interior of the visor, creating positive air pressure inside the helmet and preventing contaminated air from entering. The wicker bill design offers down-force and stability preventing the helmet from "lifting" at high speeds in open cockpit environments. The wide eye port provides an exceptional field of front and peripheral vision and includes a heavy-duty 1/8" polycarbonate shield with three-position detent. The Impact Air Draft also features our "Intelligent Gray Matter" liner (a variable-density, single-piece helmet liner) upholstered with fire-retardant soft-knit Nomex® and finishes with a fire-retardant Kevlar® chinstrap with a dual D-ring closure. Interchangeable variable density cheek pads and a variety of tinted and anti-fog shields offer a customized fit, making the Impact Carbon Fiber Air Draft the helmet of choice for the pros!

Adult Sizes: XS/S/M/L/XL



SIZE	CARBON FIBER
EXTRA SMALL	19315220
SMALL	19315320
MEDIUM	19315420
LARGE	19315520
EXTRA LARGE	19315620



AIR DRAFT SA™
CARBON FIBER - SIDE AIR INTAKE

Impact's Carbon Fiber Air Draft with the Side Air Inlet offers many of the popular features found on our other Draft models but with a side air inlet for racers looking for fresh air to be ported directly onto their face. The wicker bill design offers down-force and stability at high speeds preventing the helmet from lifting in open cockpit environments, while the wide eye port provides an excellent peripheral and frontal field of vision. The Air Draft SA is upholstered with fire retardant soft-knit Nomex® while interchangeable variable-density cheek pads offer a customized fit. The Impact Air Draft helmet is finished with a fire-retardant Kevlar® chinstrap with dual D-Ring closure, our wide eye port and 1/8" polycarbonate shield with three-position detent.

Adult Sizes: XS/S/M/L/XL



SIZE	CARBON FIBER
EXTRA SMALL	19615220
SMALL	19615320
MEDIUM	19615420
LARGE	19615520
EXTRA LARGE	19615620



DRAFT TS™
CARBON FIBER

Featuring our exclusive wide eye port, Impact's Carbon Fiber Draft TS offers an exceptional range of front and peripheral vision while providing cooling and fog free ventilation with integrated crown and chin bar vents. The extended wicker bill captures downward airflow to reduce helmet lifting and buffeting, while our "Intelligent Gray Matter" liner (a variable-density, single-piece helmet liner) is upholstered with fire retardant soft-knit Nomex® for the ultimate in comfort. Interchangeable cheek pads offer a customized fit and can be quickly and easily changed out with Impact's various cheek pads available in a wide range of thicknesses and configurations. The Impact Draft TS helmet is finished with a fire-retardant Kevlar® chin strap with dual D-Ring closure and our 1/8" polycarbonate shield with three-position detent.

Adult Sizes: XS/S/M/L/XL



SIZE	CARBON FIBER
EXTRA SMALL	19715220
SMALL	19715320
MEDIUM	19715420
LARGE	19715520
EXTRA LARGE	19715620

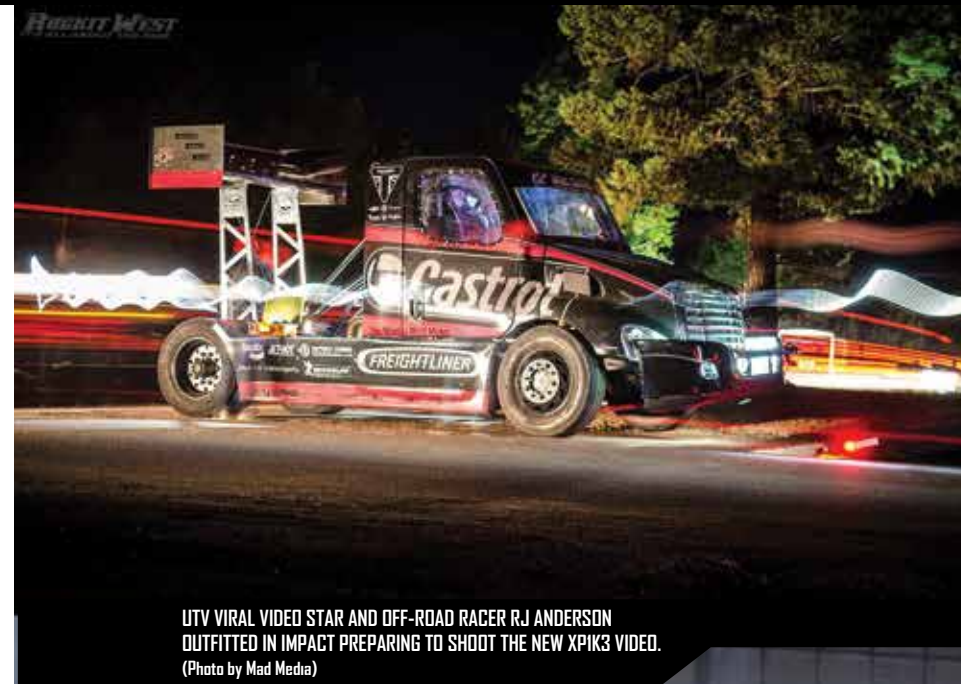

LTV VIRAL VIDEO STAR AND OFF-ROAD RACER R.J. ANDERSON OUTFITTED IN IMPACT PREPARING TO SHOOT THE NEW XPIK3 VIDEO.
(Photo by Mad Media)

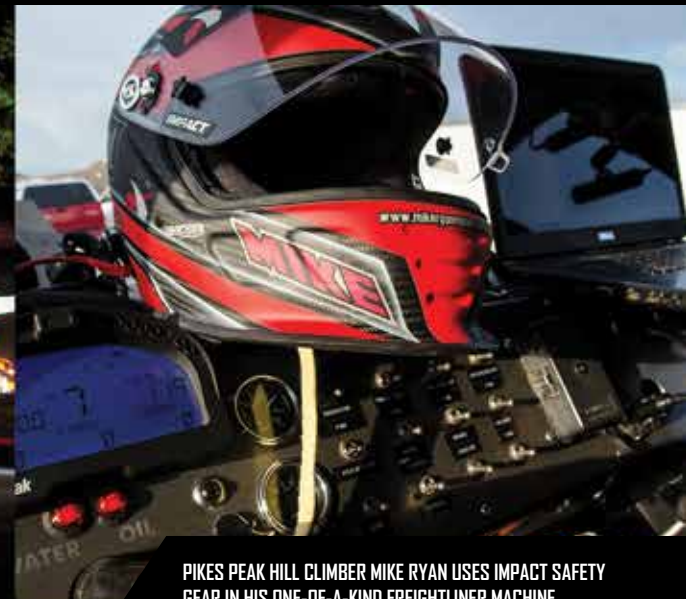

PIKES PEAK HILL CLIMBER MIKE RYAN USES IMPACT SAFETY GEAR IN HIS ONE-OF-A-KIND FREIGHTLINER MACHINE.





AIR VAPOR SC™
CARBON FIBER - TOP AIR INTAKE

Featuring an ultra-lightweight carbon fiber construction, the Air Vapor SC offers an aggressive chin bar design providing more room for the microphone while increasing driver comfort and reducing fog. The low-profile fresh air port offers maximum chassis clearance while providing the ultimate in cooling comfort with Impact's exclusive integrated "whisper" channels. Fresh air is circulated through three air ports directed onto the visor, minimizing fog and contaminants while one air port is directed onto the head and channeled towards the neck providing cooling comfort all race long. Superior ambient noise attenuation is achieved through the use of Impact's proprietary insulation foam creating a quieter race environment and reducing the potential for noise fatigue. Impact's Air Vapor SC also features a tapered lower design allowing for additional clearance between the helmet and the frontal head restraint device, thus minimizing interference between these two safety systems. Manufactured using Impact's exclusive "Intelligent Gray Matter" inner liner (a variable-density, single-piece helmet liner) and upholstered with fire-retardant soft-knit Nomex® material for superior comfort and fire protection, the Air Vapor SC offers a truly customized fit with interchangeable, variable-density cheek pads. A wide-angle, wrap-around eye port, a Kevlar® chin strap with dual D-ring closure, and a 1/8" polycarbonate shield with exceptional visual acuity finish off the newest addition to Impact's line of Made in the USA helmets.

Adult Sizes: XS/S/M/L/XL



SIZE	CARBON FIBER
EXTRA SMALL	16915220
SMALL	16915320
MEDIUM	16915420
LARGE	16915520
EXTRA LARGE	16915620



AIR VAPOR™
CARBON FIBER - TOP AIR INTAKE

Impact's Carbon Fiber Air Vapor helmet is another exclusive safety solution that has tried and true features for every racer in every form of motorsports. Impact's unique "Ripple Effect" aerodynamic modeling controls airflow around the helmet for stability while the extended chin foil captures downward airflow to reduce helmet lift and buffeting. A high-bypass air induction system circulates air around the head and face as stale air is channeled towards the rear vents. Featuring a slightly narrowed eyeport with excellent peripheral vision, the Carbon Fiber Air Vapor is the ideal choice for racers concerned with track debris entering the cockpit. Like all Impact helmets, the CF Air Vapor includes our "Intelligent Gray Matter" (a variable-density, single-piece inner liner) upholstered with fire-retardant soft-knit Nomex® material for superior comfort and fire protection. The helmet finishes off with our heavy-duty 1/8" polycarbonate shield with three-position detent, interchangeable sizing cheek pads and a Kevlar® chin strap with dual D-ring closure.

Adult Sizes: XS/S/M/L/XL



SIZE	CARBON FIBER
EXTRA SMALL	16015220
SMALL	16015320
MEDIUM	16015420
LARGE	16015520
EXTRA LARGE	16015620



VAPOR™
CARBON FIBER

Featuring Impact's unique "Ripple Effect" aerodynamic modeling and lightweight construction, the design of the Carbon Fiber Vapor helmet provides added stability to accommodate high-speed airflow, while Impact's integrated venting and air circulation system provides cooling comfort. In addition to our exclusive "Intelligent Gray Matter" liner (a single-piece, variable-density liner), the Vapor helmet features a fire retardant soft-knit Nomex® interior and interchangeable cheek pads provide a customized fit. Integrated crown and chin bar vents provide fog free ventilation keeping you cool and comfortable all race long. The Impact Vapor is finished with a fire-retardant Kevlar® chin strap with dual D-Ring closure and our 1/8" polycarbonate shield with three-position detent.

Adult Sizes: XS/S/M/L/XL



SIZE	CARBON FIBER
EXTRA SMALL	12515220
SMALL	12515320
MEDIUM	12515420
LARGE	12515520
EXTRA LARGE	12515620



VAPOR LS™
CARBON FIBER

The Vapor LS features ultra-light carbon fiber construction making this Impact's lightest weight helmet on the market. Aggressive chin-bar styling provides for additional room for the microphone while integrated vents offer cooling, fog-free comfort. Superior ambient noise attenuation is achieved through the use of Impact's proprietary insulation foam creating a quieter race environment and reducing the potential for noise fatigue. The Impact Vapor LS also offers a tapered design allowing for additional clearance between the helmet and the frontal head restraint device, thus minimizing interference between these two safety systems. Manufactured using Impact's exclusive "Intelligent Gray Matter" inner liner (a variable-density, single-piece helmet liner) and upholstered with fire-retardant soft-knit Nomex® material for superior comfort and fire protection, the Vapor LS offers a truly customized fit with interchangeable, variable-density cheek pads. A wide-angle, wrap-around eye port, Kevlar® chin strap with dual D-ring closure, and a 1/8" polycarbonate shield with exceptional visual acuity finish off the newest addition to Impact's line of Made in the USA helmets.

Adult Sizes: XS/S/M/L/XL



SIZE	CARBON FIBER
EXTRA SMALL	12915220
SMALL	12915320
MEDIUM	12915420
LARGE	12915520
EXTRA LARGE	12915620



AIR VAPOR SA™
CARBON FIBER - SIDE AIR INTAKE

Impact's Carbon Fiber Vapor with Side Air inlet offers many of the popular features found on our other Vapor models but with a side air inlet for racers looking for fresh air to be ported directly onto their faces. Featuring Impact's unique "Ripple Effect" aerodynamic modeling and lightweight construction, the design of the Vapor Side Air helmet provides added stability to accommodate high-speed airflow while the narrowed eye port offers added protection from debris. Finished with Impact's "Intelligent Gray Matter" liner (a single-piece, variable-density liner) the Vapor Side Air helmet features a fire retardant soft-knit Nomex® interior and interchangeable cheek pads provide a customized fit.

Adult Sizes: XS/S/M/L/XL



SIZE	CARBON FIBER
EXTRA SMALL	16115220
SMALL	16115320
MEDIUM	16115420
LARGE	16115520
EXTRA LARGE	16115620



NITRO™
CARBON FIBER - BOTTLED AIR INTAKE

Impact's Nitro helmet was specifically made with Alcohol and Nitro drag racers in mind, with its integrated breather system and drag specific eye port. Engineered to alleviate the fumes emitted from nitro and alcohol powered dragsters, the Nitro by Impact features a replaceable filter system and bottled air intake port. A built-in SF1 3.3/10 rated Nomex® skirt assists in keeping the fresh air contained in the helmet while the braided Kevlar eye port gasket provides an excellent fire retardant seal around the shield. The Impact Nitro also features a built-in D-ring to keep the head restrained during launch. Manufactured from Impact's exclusive "Intelligent Gray Matter" (a variable-density, single-piece inner liner) and upholstered in fire retardant soft-knit Nomex®, the interior features interchangeable cheek pads for a customized fit. The Impact Nitro also offers a variety of anti-fog, tinted, and Hi-Def Amber shields with excellent visual acuity for the most accurate read of the tree.

Adult Sizes: XS/S/M/L/XL



SIZE	CARBON FIBER
EXTRA SMALL	18015220
SMALL	18015320
MEDIUM	18015420
LARGE	18015520
EXTRA LARGE	18015620

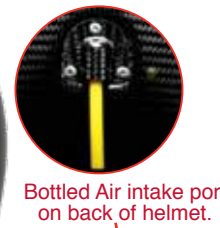

Bottled Air intake port on back of helmet.



LONG-TIME IMPACT SUPPORTER GRAY GAULDING BEFORE ONE OF HIS NASCAR CAMPING WORLD TRUCK SERIES APPEARANCES FOR KYLE BUSCH MOTORSPORTS IN 2015.



NASCAR SPRINT CUP RACER, DAVID RAGAN, GREETING HIS FANS BEFORE THE 2015 DAYTONA 500 IN HIS IMPACT SUIT.



RYAN TAYLOR, WINGED 410 SPRINT DRIVER, SUITED-UP IN IMPACT GEAR, CLIMING IN FOR ANOTHER RUN ON THE DIRT.



AIR DRAFT OS20™
CARBON/KEVLAR - 20 DEGREE OFFSET AIR INTAKE

As dirt and off-road racers ourselves, we understand the importance of a helmet that fits and performs in the most extreme environments. Featuring a wide eye port, the Impact Air Draft OS20 offers an exceptional range of peripheral vision while the wicker bill design provides aerodynamic down-force to reduce the potential of the helmet "lifting" at high speeds. The off-centered and left-positioned air inlet offers added overhead clearance in the cockpit while the air port is angled 20 degrees to provide ease of movement with the fresh air hose. Cooling comfort and fresh air is pumped through three individual air channels routed to direct air onto the visor further reducing fog and contaminates from interfering with the visual field. The unique placement of the air channels also eliminates the fresh air system from "opening" the microphone and interfering with the communication system. Additional features such as a built-in chin deflector and the Nomex® covered eye port gasket practically eliminate dust and contaminates from entering the interior of the helmet while offering added thermal protection. Variable-density interchangeable cheek pads and a variety of anti-fog and tinted shields make this helmet truly customizable for a perfect fit. Manufactured from Impact's "Intelligent Gray Matter" inner liner and upholstered with soft-knit fire-retardant Nomex® fabrics, the Air Draft OS20 is the helmet of choice for dirt track and off-road racers alike!

Adult Sizes: XS/S/M/L/XL

SIZE	SILVER	WHITE	GLOSS BLACK	FLAT BLACK +\$20
EXTRA SMALL	19915208	19915209	19915210	19915212
SMALL	19915308	19915309	19915310	19915312
MEDIUM	19915408	19915409	19915410	19915412
LARGE	19915508	19915509	19915510	19915512
EXTRA LARGE	19915608	19915609	19915610	19915612



AIR DRAFT™
CARBON/KEVLAR - TOP AIR INTAKE

Impact's Air Draft Top Air offers many of the custom features found on our OS20, but with a top air inlet for racers not limited on overhead chassis space and wanting the look of our aggressive and patented top air technology. Cooling comfort and fresh air is directed through three "whisper" channels routed onto the visor reducing fog and contaminates from interfering with the visual field and eliminating air interference with the microphone. The wicker bill design offers down-force and stability at high speeds preventing the helmet from lifting in open cockpit environments while the wide eye port provides an excellent front and peripheral field of vision. Our "Intelligent Gray Matter" liner (a variable-density, single-piece helmet liner) is upholstered with fire-retardant soft-knit Nomex® and interchangeable variable-density cheek pads offer a customized fit. The Impact Top Air Draft helmet is finished with a fire-retardant Kevlar® chin strap with dual D-Ring closure, and a 1/8" polycarbonate shield with three-position detent.

Adult Sizes: XS/S/M/L/XL

SIZE	SILVER	WHITE	GLOSS BLACK	FLAT BLACK +\$20
EXTRA SMALL	19315208	19315209	19315210	19315212
SMALL	19315308	19315309	19315310	19315312
MEDIUM	19315408	19315409	19315410	19315412
LARGE	19315508	19315509	19315510	19315512
EXTRA LARGE	19315608	19315609	19315610	19315612



AIR DRAFT SA™
CARBON/KEVLAR - SIDE AIR INTAKE

Impact's Air Draft with the Side Air Inlet offers many of the popular features found on our other Draft models, but with a side air inlet for racers looking for fresh air to be ported directly onto their face. The wicker bill design offers down-force and stability at high speeds preventing the helmet from "lifting" in open cockpit environments. A wide eye port provides an excellent field of front and peripheral vision and features a Nomex® covered eye port gasket minimizing dirt and contaminates from entering the helmet while also providing superior thermal protection. Impact's "Intelligent Gray Matter" (a variable-density, single-piece helmet liner) is upholstered with fire-retardant soft-knit Nomex® and variable-density interchangeable cheek pads offer a customized fit. The Impact Air Draft Side Air is finished with a fire-retardant Kevlar® chin strap with dual D-ring closure and 1/8" polycarbonate shield with three-position detent.

Adult Sizes: XS/S/M/L/XL

SIZE	SILVER	WHITE	GLOSS BLACK	FLAT BLACK +\$20
EXTRA SMALL	19615208	19615209	19615210	19615212
SMALL	19615308	19615309	19615310	19615312
MEDIUM	19615408	19615409	19615410	19615412
LARGE	19615508	19615509	19615510	19615512
EXTRA LARGE	19615608	19615609	19615610	19615612



DRAFT TS™
CARBON/KEVLAR

Featuring our exclusive wide eye port, Impact's Draft TS offers an exceptional range of front and peripheral vision, while providing cooling and fog free ventilation with integrated crown and chin bar vents. The extended wicker bill captures downward airflow to reduce helmet lifting and buffeting while our "Intelligent Gray Matter" liner (a variable-density, single-piece helmet liner) is upholstered with fire retardant soft-knit Nomex® for the ultimate in comfort. Interchangeable cheek pads offer a customized fit and can be quickly and easily changed out with Impact's various cheek pads available in a wide range of thicknesses and configurations. The Impact Draft TS helmet is finished with a fire-retardant Kevlar® chin strap with a dual D-Ring closure and our 1/8" polycarbonate shield with three-position detent.

Adult Sizes: XS/S/M/L/XL

SIZE	SILVER	WHITE	GLOSS BLACK	FLAT BLACK +\$20
EXTRA SMALL	19715208	19715209	19715210	19715212
SMALL	19715308	19715309	19715310	19715312
MEDIUM	19715408	19715409	19715410	19715412
LARGE	19715508	19715509	19715510	19715512
EXTRA LARGE	19715608	19715609	19715610	19715612



ROBBY GORDON AND CO-DRIVER JOHNNY CAMPBELL GET READY FOR THE START OF A 2015 DAKAR RALLY STAGE, ALWAYS IN IMPACT.



RALLY X™
CARBON/KEVLAR

Impact's RallyX is an ultra-lightweight carbon fiber and Kevlar® composite open-faced helmet designed specifically for the racer wanting the ultimate in protection but not necessarily needing a full-face helmet. The RallyX is the perfect choice for Autocross, Pro Touring and Rally racing as well as any other type of activity where a full-face helmet is not necessary. Manufactured in the USA from revolutionary, lightweight composite materials and featuring a full-length sun-visor, the Impact RallyX is the choice of renowned racers such as Robby Gordon during the Dakar Rally Raids.

Adult Sizes: XS/S/M/L/XL

SIZE	SILVER	WHITE	GLOSS BLACK	FLAT BLACK +\$20
EXTRA SMALL	15415208	15415209	15415210	15415212
SMALL	15415308	15415309	15415310	15415312
MEDIUM	15415408	15415409	15415410	15415412
LARGE	15415508	15415509	15415510	15415512
EXTRA LARGE	15415608	15415609	15415610	15415612





VAPOR SC™
CARBON/KEVLAR

The Air Vapor SC offers aggressive chin bar design providing more room for the microphone while increasing driver comfort and reducing fog. The low-profile fresh air port offers maximum chassis clearance while providing the ultimate in cooling comfort with Impact's exclusive integrated "whisper" channels. Fresh air is circulated through three air ports directed onto the visor, minimizing fog and contaminates while one air port is directed onto the head and channeled towards the neck providing cooling comfort all race long. Superior ambient noise attenuation is achieved through the use of Impact's proprietary insulation foam creating a quieter race environment and reducing the potential for noise fatigue. Impact's Air Vapor SC also features a tapered lower design allowing for additional clearance between the helmet and the frontal head restraint device, thus minimizing interference between these two safety systems. Manufactured using Impact's exclusive "Intelligent Gray Matter" inner liner (a variable-density, single-piece helmet liner) and upholstered with fire-retardant soft-knit Nomex® material for superior comfort and fire protection, the Air Vapor SC offers a truly customized fit with interchangeable, variable-density cheek pads. A wide-angle, wrap-around eye port, a Kevlar® chin strap with dual D-ring closure, and a 1/8" polycarbonate shield with exceptional visual acuity finish off the newest addition to Impact's line of Made in the USA helmets.

Adult Sizes: XS/S/M/L/XL



SIZE	SILVER	WHITE	GLOSS BLACK	FLAT BLACK +\$20
EXTRA SMALL	16915208	16915209	16915210	16915212
SMALL	16915308	16915309	16915310	16915312
MEDIUM	16915408	16915409	16915410	16915412
LARGE	16915508	16915509	16915510	16915512
EXTRA LARGE	16915608	16915609	16915610	16915612



AIR VAPOR™
CARBON/KEVLAR - TOP AIR INTAKE

Impact's Air Vapor helmet is another exclusive safety solution that has tried and true features for every racer in every form of motorsports. Impact's unique "Ripple Effect" aerodynamic modeling controls airflow around the helmet for stability while the extended chin foil captures downward airflow to reduce helmet lift and buffeting. A high-bypass air induction system circulates air around the head and face as stale air is channeled towards the dual rear exhaust vents. Featuring a slightly narrowed eye port with excellent peripheral field of vision, the Air Vapor helmet is the ideal choice for racers concerned with track debris entering the cockpit. Proudly manufactured in the heart of Gasoline Alley, the Impact Air Vapor is the result of driver feedback, making this a helmet for racers, by racers. Like all of Impact's helmets, the Air Vapor includes our fire-retardant, variable-density, single-piece Gray Matter helmet liner, a three-position detent 1/8" polycarbonate shield, interchangeable sizing cheek pads and a fire-retardant Kevlar® chin strap with dual D-Ring closure.

Adult Sizes: XS/S/M/L/XL



SIZE	SILVER	WHITE	GLOSS BLACK	FLAT BLACK +\$20
EXTRA SMALL	16015208	16015209	16015210	16015212
SMALL	16015308	16015309	16015310	16015312
MEDIUM	16015408	16015409	16015410	16015412
LARGE	16015508	16015509	16015510	16015512
EXTRA LARGE	16015608	16015609	16015610	16015612



VAPOR™
CARBON/KEVLAR

The Impact Vapor features unique "Ripple Effect" aerodynamic modeling and a wicker bill design providing added stability and down-force to accommodate high-speed airflow. Manufactured from a blend of carbon fiber and Kevlar materials, the Impact Vapor is lightweight and capable of withstanding a full race season of abuse, making it the helmet of choice for dirt-track racing legend, Jerry Coons, Jr. Featuring a slightly narrowed eye port with excellent peripheral field of vision, the Air Vapor helmet is the ideal choice for racers concerned with track debris entering the cockpit. Integrated crown and chin bar vents provide fog free ventilation, keeping you cool and comfortable all race long. Manufactured from our exclusive "Intelligent Gray Matter" (a single-piece, variable-density inner liner) upholstered in fire retardant soft-knit Nomex®, the Impact Vapor also offers interchangeable cheek pads available in a variety of thicknesses for a customized fit. The helmet finishes with a Kevlar® chin strap with dual D-ring closure and 1/8" polycarbonate shield with three-position detent.

Adult Sizes: XS/S/M/L/XL



SIZE	SILVER	WHITE	GLOSS BLACK	FLAT BLACK +\$20
EXTRA SMALL	12515208	12515209	12515210	12515212
SMALL	12515308	12515309	12515310	12515312
MEDIUM	12515408	12515409	12515410	12515412
LARGE	12515508	12515509	12515510	12515512
EXTRA LARGE	12515608	12515609	12515610	12515612



VAPOR LS™
CARBON/KEVLAR

The Vapor LS is loaded with many of the popular features found on our Vapor SC and is perfectly suited for racers looking for a helmet that offers additional noise attenuation but not requiring a fresh air port. Aggressive chin-bar styling provides for additional room for the microphone while integrated vents offer cooling, fog-free comfort. Superior ambient noise attenuation is achieved through the use of Impact's proprietary insulation foam creating a quieter race environment and reducing the potential for noise fatigue. The Impact Vapor LS also offers a tapered design allowing for additional clearance between the helmet and the frontal head restraint device, thus minimizing interference between these two safety systems. Manufactured using Impact's exclusive "Intelligent Gray Matter" inner liner (a variable-density, single-piece helmet liner) and upholstered with fire-retardant soft-knit Nomex® material for superior comfort and fire protection, the Vapor LS offers a truly customized fit with interchangeable, variable-density cheek pads. A wide-angle, wrap-around eye port, a Kevlar® chin strap with dual D-ring closure, and a 1/8" polycarbonate shield with exceptional visual acuity finish off the newest addition to Impact's line of Made in the USA helmets.

Adult Sizes: XS/S/M/L/XL



SIZE	SILVER	WHITE	GLOSS BLACK	FLAT BLACK +\$20
EXTRA SMALL	12915208	12915209	12915210	12915212
SMALL	12915308	12915309	12915310	12915312
MEDIUM	12915408	12915409	12915410	12915412
LARGE	12915508	12915509	12915510	12915512
EXTRA LARGE	12915608	12915609	12915610	12915612



AIR VAPOR SA™
CARBON/KEVLAR - SIDE AIR INTAKE

Impact's Vapor with Side Air inlet offers many of the popular features found on our other Vapor models but with a side air inlet for racers looking for fresh air to be ported directly onto their faces. Featuring Impact's unique "Ripple Effect" aerodynamic modeling and lightweight construction, the design of the Vapor Side Air helmet provides added stability to accommodate high-speed airflow while the narrowed eye port offers added protection from debris. Finished with Impact's "Intelligent Gray Matter" liner (a single-piece, variable-density liner) the Vapor Side Air helmet features a fire retardant soft-knit Nomex® interior and interchangeable cheek pads provide a customized fit.

Adult Sizes: XS/S/M/L/XL



SIZE	SILVER	WHITE	GLOSS BLACK	FLAT BLACK +\$20
EXTRA SMALL	16115208	16115209	16115210	16115212
SMALL	16115308	16115309	16115310	16115312
MEDIUM	16115408	16115409	16115410	16115412
LARGE	16115508	16115509	16115510	16115512
EXTRA LARGE	16115608	16115609	16115610	16115612

LARRY RAGLAND PILOTING HIS POLARIS RZR ON THE 2015 MAD MEDIA BAJA UTV EVENT.
(Photo by Mad Media)





PROUD TO PROTECT DSR'S TONY SCHUMACHER DURING ALL THE UNEXPECTED MOMENTS THROUGHOUT HIS CAREER. (Photos by Mark Rebilas)



Bottled Air intake port on back of helmet.



NITRO™

CARBON/KEVLAR - BOTTLED AIR INTAKE

Impact's Nitro helmet was specifically made with Alcohol and Nitro drag racers in mind with its integrated breather system and drag specific eye port. Engineered to alleviate the fumes emitted from nitro and alcohol powered dragsters, the Nitro by Impact features a replaceable filter system and bottled air intake port. A built-in SFI 3.3/10 rated Nomex® skirt assists in keeping the fresh air contained in the helmet while the braided Kevlar eye port gasket provides an excellent fire retardant seal around the shield. The Impact Nitro also features a built-in D-ring to keep the head restrained during launch. Manufactured from Impact's exclusive "Intelligent Gray Matter" (a variable-density, single-piece inner liner) and upholstered in fire retardant soft-knit Nomex®, the interior features interchangeable cheek pads for a customized fit. The Impact Nitro also offers a variety of anti-fog, tinted, and Hi-Def Amber shields with excellent visual acuity for the most accurate read of the tree.

Adult Sizes: XS/S/M/L/XL



SIZE	SILVER	WHITE	GLOSS BLACK	FLAT BLACK +\$20
EXTRA SMALL	18015208	18015209	18015210	18015212
SMALL	18015308	18015309	18015310	18015312
MEDIUM	18015408	18015409	18015410	18015412
LARGE	18015508	18015509	18015510	18015512
EXTRA LARGE	18015608	18015609	18015610	18015612

CHAMP™

LIGHT-WEIGHT AEROSPACE COMPOSITES

The aggressive and unique chin bar styling of Impact's Champ helmet is designed to cover the mouth and nose; a feature that acts as a built-in breath deflector minimizing fumes inside the helmet and reducing fog on the shield. The integrated slotted vents on the forehead provide for additional ventilation, while our exclusive "Ripple Effect" helmet crown and wicker bill create aerodynamic stabilization. Manufactured from Impact's exclusive "Intelligent Gray Matter" (a variable-density, single-piece inner liner) and upholstered in our fire-retardant soft-knit Nomex® material, the Champ features interchangeable cheek pads available in various densities for a customized fit. A fire-retardant Kevlar® chin strap with dual D-ring closure and a 1/8" polycarbonate shield with three-position detent finish off this helmet. The Impact Champ also offers a variety of anti-fog, tinted, and Hi-Def Amber shields with excellent visual acuity for the most accurate read of the tree.

Adult Sizes: XS/S/M/L/XL/XXL



SIZE	SILVER	WHITE	GLOSS BLACK	FLAT BLACK +\$20
EXTRA SMALL	13015208	13015209	13015210	13015212
SMALL	13015308	13015309	13015310	13015312
MEDIUM	13015408	13015409	13015410	13015412
LARGE	13015508	13015509	13015510	13015512
EXTRA LARGE	13015608	13015609	13015610	13015612
XXL	13015708	13015709	13015710	13015712



CHARGER™

AEROSPACE COMPOSITES

The Impact Charger is designed with a wrap-around eye port for a wide-angle panoramic view. Featuring a wicker bill design for aerodynamic down-force and air flow stabilization, the Impact Charger also features integrated air induction ports along the crown for cooling ventilation. Manufactured from our exclusive "Intelligent Gray Matter" (a variable-density, single-piece inner liner) and upholstered in fire retardant soft-knit Nomex®, the Impact Charger also features interchangeable cheek pads for a customized fit. A fire retardant Kevlar® chin strap with dual D-ring closure and our 1/8" polycarbonate shield with three-position detent are also standard features.

Adult Sizes: XS/S/M/L/XL/XXL



SIZE	SILVER	WHITE	GLOSS BLACK	FLAT BLACK +\$20
EXTRA SMALL	14015208	14015209	14015210	14015212
SMALL	14015308	14015309	14015310	14015312
MEDIUM	14015408	14015409	14015410	14015412
LARGE	14015508	14015509	14015510	14015512
EXTRA LARGE	14015608	14015609	14015610	14015612
XXL	14015708	14015709	14015710	14015712

SUPER CHARGER™

AEROSPACE COMPOSITES - TOP AIR INLET

The Impact Super Charger is a top air version of our popular Charger helmet and features Impact's low-profile head-dress air induction system providing concentrated and continuous ventilation. Designed with our exclusive wide-angle eye port, the Super Charger Top Air offers a panoramic field of vision and features a heavy-duty 1/8" polycarbonate shield available in a variety of anti-fog and tinted options. Featuring Impact's exclusive "Intelligent Gray Matter" (a single-piece, variable-density inner liner) upholstered in fire-retardant soft-knit Nomex®, the Impact Super Charger Top Air also includes interchangeable cheek pads for a customized fit.

Adult Sizes: XS/S/M/L/XL/XXL



SIZE	SILVER	WHITE	GLOSS BLACK	FLAT BLACK +\$20
EXTRA SMALL	17015208	17015209	17015210	17015212
SMALL	17015308	17015309	17015310	17015312
MEDIUM	17015408	17015409	17015410	17015412
LARGE	17015508	17015509	17015510	17015512
EXTRA LARGE	17015608	17015609	17015610	17015612
XXL	17015708	17015709	17015710	17015712



SUPER CHARGER SA™

AEROSPACE COMPOSITES - SIDE AIR INLET

The Super Charger Side Air offers many of the popular features and benefits of our Top Air version except with a side inlet for racers looking for the fresh air port to be directed onto their face or are limited by the overhead chassis clearance. Designed with an oversized wrap-angle eye port, the Super Charger Side Air offers a panoramic field of vision and features a heavy-duty 1/8" polycarbonate shield available in a variety of anti-fog and tinted options. Featuring Impact's exclusive "Intelligent Gray Matter" (a single-piece, variable-density inner liner) upholstered in fire-retardant soft-knit Nomex®, the Impact Super Charger Side Air also includes interchangeable cheek pads for a customized fit.

Adult Sizes: XS/S/M/L/XL/XXL



SIZE	SILVER	WHITE	GLOSS BLACK	FLAT BLACK +\$20
EXTRA SMALL	17915208	17915209	17915210	17915212
SMALL	17915308	17915309	17915310	17915312
MEDIUM	17915408	17915409	17915410	17915412
LARGE	17915508	17915509	17915510	17915512
EXTRA LARGE	17915608	17915609	17915610	17915612
XXL	17915708	17915709	17915710	17915712





1320™
AEROSPACE COMPOSITES

On a budget, but not wanting to compromise safety? Impact's 1320 is a value-packed helmet manufactured right in the heart of Indy's Gasoline Alley. Featuring our exclusive "Intelligent Gray Matter" (a variable-density, single-piece inner liner) and upholstered in fire retardant soft-knit Nomex®, the 1320 offers many of the features and benefits that have made Impact helmets a "must have" safety item for racers in all forms of motorsports. The 1320 is a custom hand-crafted fiberglass shell manufactured to Impact's exacting standards and provides racers with an affordable Made in the USA helmet without compromising safety or quality. Featuring our exclusive wide eye port and integrated upper and lower air vents for superior ventilation, the Impact 1320 also includes interchangeable cheek pads for a customized fit. A fire-retardant Kevlar® chin strap with dual D-ring closure and our 1/8" polycarbonate shield with three-position detent finish off this value-packed helmet. Adult Sizes: XS/S/M/L/XL



SIZE	SILVER	WHITE	GLOSS BLACK	FLAT BLACK +\$20
EXTRA SMALL	14515208	14515209	14515210	14515212
SMALL	14515308	14515309	14515310	14515312
MEDIUM	14515408	14515409	14515410	14515412
LARGE	14515508	14515509	14515510	14515512
EXTRA LARGE	14515608	14515609	14515610	14515612



1320 TOP AIR™
AEROSPACE COMPOSITES - TOP AIR INTAKE

The 1320 Top Air features all the same value-packed options as Impact's 1320 helmet but with the addition of fresh air comfort circulated through air port channels directed onto the visor, minimizing fog and contaminates while also providing fresh air and cooling comfort. Manufactured from our exclusive "Intelligent Gray Matter" (a variable-density, single-piece inner liner) and upholstered in fire-retardant soft-knit Nomex®, the 1320 Top Air offers many of the features and benefits that have made our helmets a "must have" safety item for racers in all forms of motorsports. The 1320 Top Air is a custom handcrafted fiberglass shell manufactured to Impact's exacting standards providing racers with an affordable Made in the USA helmet without compromising safety or quality. Featuring our exclusive wide eye port, the Impact 1320 Top Air also includes interchangeable cheek pads for a customized fit. A fire-retardant Kevlar® chin strap with dual D-ring closure and our 1/8" polycarbonate shield with three-position detent finish off this value-packed helmet. Adult Sizes: XS/S/M/L/XL



SIZE	SILVER	FLAT BLACK +\$20
EXTRA SMALL	14815208	14815212
SMALL	14815308	14815312
MEDIUM	14815408	14815412
LARGE	14815508	14815512
EXTRA LARGE	14815608	14815612



1320 SIDE AIR™
AEROSPACE COMPOSITES - SIDE AIR INTAKE

Do you like the value-packed options and pricing of our 1320 helmet but need something with a fresh air port? Featuring a factory-installed air port, the Impact 1320 Side Air provides continuous fresh air channeled through the chin bar and providing cooling comfort directed onto the face. Manufactured from our exclusive "Intelligent Gray Matter" (a variable-density, single-piece inner liner) and upholstered in fire-retardant soft-knit Nomex®, the 1320 offers many of the features and benefits that have made our helmets a "must have" safety item for racers in all forms of motorsports. The 1320 SA is a custom handcrafted fiberglass shell manufactured to Impact's exacting standards and providing racers with an affordable Made in the USA helmet without compromising safety or quality. Featuring our exclusive wide eye port, the Impact 1320 SA also includes interchangeable cheek pads for a customized fit. A fire-retardant Kevlar® chin strap with dual D-ring closure and our 1/8" polycarbonate shield with three-position detent finish off this value-packed helmet. Adult Sizes: XS/S/M/L/XL



SIZE	SILVER	FLAT BLACK +\$20
EXTRA SMALL	14715208	14715212
SMALL	14715308	14715312
MEDIUM	14715408	14715412
LARGE	14715508	14715512
EXTRA LARGE	14715608	14715612



NASCAR CAMPING WORLD TRUCK SERIES DRIVER, CASSIE GANNIS IN HER CF AIR DRAFT DS20 HELMET AND CUSTOM IMPACT SUIT. (Photos by Brad Rogers)



NHRA PRO STOCK MOTORCYCLE VETERAN ANGELLE SAMPEY IN THE STAGING LANES IN HER CUSTOM IMPACT HELMET.





MINI-AIR DRAFT OS20™

CARBON/KEVLAR

Looking for a fresh air helmet for the aspiring racer in your household? Look no further than Impact's new Mini Air Draft OS20 offering cooling comfort with the added benefit of minimizing fog. Featuring our wrap-around wide-angle eye port for a panoramic view, the Impact Mini Air Draft OS20 was inspired by it's full-size and best-selling counterpart that has become a mainstay with dirt and off-road racers alike. The off-centered and left positioned air inlet offers added overhead clearance in the cockpit while the air port is angled 20 degrees to provide ease of movement with the fresh air hose. Cooling comfort and fresh air is pumped through three individual air channels routed to direct air onto the visor further reducing fog and contaminates from interfering with the visual field. The unique placement of the air channels also eliminates the fresh air system from "opening" the microphone and interfering with the communication system. Featuring a wider eye port, the Mini Air Draft OS20 offers an exceptional range of peripheral vision while the wicker bill design provides aerodynamic down-force to reduce the helmet from lifting. Variable density sizing pads and a variety of anti-fog and tinted shields make this helmet truly customizable for a perfect fit. The Mini Air Draft OS20 also includes Impact's fire-retardant, "Intelligent Gray Matter" helmet liner, a 1/8" polycarbonate shield with three-position detent and a fire-retardant Kevlar® chin strap with dual D-Ring closure
 Sizes: One Size Fits Most

	SA 2015 SNELL CERTIFIED	MADE IN THE USA	CARBON KEVLAR TRI-WEAVE
SIZE	SILVER	FLAT BLACK +\$20	
ONE SIZE FITS MOST	11615308	11615312	

MINI-VAPOR™

CARBON/KEVLAR

Finding and fitting a helmet for the aspiring racer in your household just got easier with Impact's line of Mini helmets. The Mini-Vapor by Impact features a miniaturized version of our standard Vapor helmet and includes Quick Fit Inserts (memory foam sizing pads) to adjust the fit from a junior small to a junior large. Featuring our wrap-around wide-angle eye port for a panoramic view, the Impact Mini Vapor is inspired by our standard Vapor helmet and is designed using the "Ripple Effect" crown and wicker bill for aerodynamic stabilization. Front air vents at the forehead and chin bar provide cooling comfort and air circulation while minimizing fog and interchangeable variable density cheek pads offer a customized fit. The Mini-Vapor also includes Impact's fire-retardant, "Intelligent Gray Matter" helmet liner, a 1/8" polycarbonate shield with three-position detent and a fire-retardant Kevlar® chin strap with dual D-Ring closure.
 Sizes: One Size Fits Most

	SA 2015 SNELL CERTIFIED	MADE IN THE USA	CARBON KEVLAR TRI-WEAVE	
SIZE	SILVER	WHITE	GLOSS BLACK	FLAT BLACK +\$20
ONE SIZE FITS MOST	11315308	11315309	11315310	11315312

MINI-CHAMP™

CARBON/KEVLAR

The Mini-Champ by Impact is a miniaturized version of our popular Champ helmet and includes Quick Fit Inserts (memory foam sizing pads) to adjust the fit from a junior small to a junior large. Designed with an aggressive and unique chin bar that covers the mouth and nose; this feature acts as a built-in breath deflector minimizing fumes inside the helmet and reducing fog on the shield. The wicker bill provides aerodynamic stabilization and the Impact Mini-Champ also includes frontal air vents at the forehead to provide cooling comfort and air circulation. Interchangeable variable density cheek pads offer a customized fit and the Mini-Champ also includes Impact's fire-retardant, "Intelligent Gray Matter" helmet liner, a 1/8" polycarbonate shield with three position-detent and a fire-retardant Kevlar® chin strap with dual D-Ring closure.
 Sizes: One Size Fits Most

	SA 2015 SNELL CERTIFIED	MADE IN THE USA	CARBON KEVLAR TRI-WEAVE	
SIZE	SILVER	WHITE	GLOSS BLACK	FLAT BLACK +\$20
ONE SIZE FITS MOST	11415308	11415309	11415310	11415312

MINI-HELMET SIZING

Mini-Vapor, Mini-Champ, and Mini-Air Draft OS20

Impact Size:	Small - Two Inserts	Medium - One Insert	Large - No Inserts
Hat Size:	6 1/8 to 6 1/4	6 3/8 to 6 1/2	6 5/8 to 6 3/4
Inch Size:	19 to 19 1/4	19 1/2 to 20	20 1/2 to 21

If you are afraid of failure, you will never succeed. You have to take chances.

- Mario Andretti



P2 CREW™

Troy Lee Designs

The Impact P2 helmet by Troy Lee Designs balances form and function with its unique styling and high-flow ventilation features. Constructed from a lightweight composite material, the Impact P2 by TLD is designed with high-flow ventilation ports and exhaust vents providing continuous air-flow and a superior cooling effect, even in the most demanding environments. The low-profile orbit visor provides custom height placement and ease of adjustability with its precision-machined cross-top aluminum hardware while the large eye port offers a large field of vision and allows for easy fitting with most goggles.

Adult Sizes: XS-S/M-L/XL-XL



	SIZE	WHITE	FLAT BLACK +\$20
	EXTRA SMALL/SMALL	18502309	18502312
	MEDIUM/LARGE	18504509	18504512
	EXTRA LARGE/XXL	18506709	18506712



P3 CREW™

Troy Lee Designs

The Impact P3 by Troy Lee Designs is the ultimate pit crew helmet and the pinnacle of style and safety with its ultra-lightweight UNI carbon shell and featherweight titanium hardware. Featuring a dual density shock pad system and adjustable height visor, the Impact P3 by TLD also offers high-flow intake and exhaust ports and deeper EPS channeling to provide optimal ventilation. The removable cheek pads are washable and replaceable and feature TLD's exclusive MX-style comfort liner. The P3 helmet easily fastens and unfastens with the included quick-clip chin closure.
 Adult Sizes: XS-S/M-L/XL-XL



	SIZE	UNI FIBER
	SMALL	18700320
	MEDIUM	18700420
	LARGE	18700520
	EXTRA LARGE	18700620

CREW FUELER™

AEROSPACE COMPOSITES

Updated for the 2016 season, the Impact Crew Fueler now features a Snell rating, as many professional motorsports are now requiring rated helmets for pit crew fuelers. Featuring an all-axis eye port for a panoramic view, the Impact Crew Fueler is the ideal choice for maintaining awareness when the pit box goes hot. The 1/8" heavy-duty polycarbonate shield provides excellent visual acuity while the Nomex covered gasket provides a tight-seal with excellent thermal performance. The Impact Crew Fueler is finished with our "Intelligent Gray Matter" helmet liner and is upholstered with a soft-knit Nomex® interior ensuring superior impact and fire protection.
 Adult Sizes: XS/S/M/L/XL



	SIZE	SILVER	WHITE	GLOSS BLACK	FLAT BLACK +\$20
	EXTRA SMALL	19015208	19015209	19015210	19015212
	SMALL	19015308	19015309	19015310	19015312
	MEDIUM	19015408	19015409	19015410	19015412
	LARGE	19015508	19015509	19015510	19015512
	EXTRA LARGE	19015608	19015609	19015610	19015612



AUTOGRAPH HELMET

NOT INTENDED FOR MOTORSPORTS USE!

Our Autograph helmet is just that, a life-sized helmet on which you may collect your favorite drivers' autographs. This helmet is **NOT intended for motorsports use**. It is only to be used as a collector's item to display your autograph collection.
 Colors: White / Flat Black

	COLOR	WHITE	FLAT BLACK +\$20
		10000003	10000039





NASCAR WHELEN SERIES DRIVER, DANNY BOHN, GETTING READY FOR A QUALIFYING RUN IN IMPACT SAFETY GEAR.

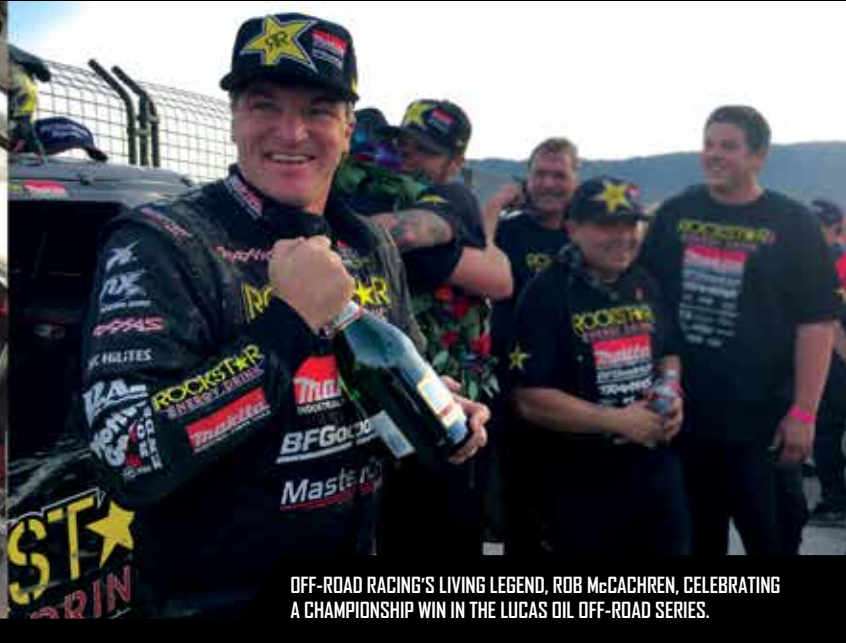

OFF-ROAD RACING'S LIVING LEGEND, ROB McCACHREN, CELEBRATING A CHAMPIONSHIP WIN IN THE LUCAS OIL OFF-ROAD SERIES.



BRENDAN GAUGHAN, NASCAR AND OFF-ROAD RACER, RUNNING THROUGH THE TRACK IN HIS HEAD BEFORE A RACE IN HIS IMPACT AIR DRAFT HELMET.

FACTORY INSTALLED RADIO KITS

JACKS AND CONDUCTORS



Using the proper jack & conductor set-up is essential as each form of motorsports has their own set of wiring schematic standards. An improper jack/conductor system will prevent communication capabilities so be sure to verify the conductor style required for your series prior to ordering.

OFF-ROAD RADIO KITS

P.C.I. 4-Pin Connector, Standard Flex Boom - Complete with Microphone *Dynamic Noise Canceling Mic Upgrade Available - Call for Details		
Factory Installed Ear Jack Only with Mic	10000028	
Factory Installed Ear Jack & Speaker Combo with Mic	10000027	
Factory Installed Ear Jack & Ear Cups wired with Speakers & Mic	10000069	
Upgrade to Extreme Microphone	10000084	
Racing Electronics 4-Pin Connector - Complete with Compact Mini-Boom Microphone		
Factory Installed Ear Jack Only with Dynamic Noise Cancelling Mini-Mic & Thick Flex Boom	10000082	
Factory Installed Ear Jack & Speaker Combo with Dynamic Noise Cancelling Mini-Mic & Thick Flex Boom	10000081	
Factory Installed Ear Jack & Ear Cups with Speakers, Dynamic Noise Cancelling Mini-Mic & Thick Flex Boom	10000080	



Driver Pod - Coiled Cord



Driver Pod - Straight Cord

*DRAG RADIO KITS

Drag racers: depending on the communications system you and/or your car owner have installed, either the Racing Electronics 3-pin "Stock Car" or the 4-pin "Open Wheel" radio kits below will be what you'll need to order. Check with your crew chief and just let us know when you order.

STOCK CAR & *DRAG RADIO KITS

Racing Electronics 3-Pin Connector - External Pod Mount Housing on Driver's Right (Mic Sold Separately)		
Factory Installed RT-900 Style Housing Kit - Straight Cord	10000073	
Factory Installed RT-900 Style Housing Kit - Coiled Cord	10000072	
Factory Installed Ear Jack & Ear Cups with Speakers, Dynamic Noise Cancelling Mini-Mic & Flex Boom	10000078	

OPEN-WHEEL & *DRAG RADIO KITS

Racing Electronics 4-Pin Connector - External Pod Mount Housing on Driver's Right (Mic Sold Separately)		
Factory Installed RT-910 Style Housing Kit - Straight Cord	10000071	
Factory Installed RT-9100 Style Housing Kit - Coiled Cord	10000070	
Factory Installed Ear Jack & Ear Cups with Speakers, Dynamic Noise Cancelling Mini-Mic & Flex Boom	10000079	

OVER-THE-WALL RADIO KITS

Racing Electronics - External Pod Mount Housing on Crew's Left (Mic Sold Separately)		
Factory Installed RT-900 Style Housing Kit	10000074	



Crew Pod - Straight Cord

MICROPHONE KITS

Racing Electronics - (Housing Sold Separately)		
Factory Installed RT-609 Standard Boom	10000076	
Factory Installed RT-609-T Thick Boom	10000075	
Factory Installed RT-709 Over-The-Wall	10000077	

HELMET SHIELDS

Manufactured from the highest grade, UV-stabilized optical quality polycarbonate material available, Impact's helmet shields feature superior dimensional stability, high temperature resistance, outstanding impact strength, and exceptional clarity for the ultimate in visual acuity. Available in various anti-fog and tinted options, Impact has a shield to suit your needs!



MADE IN THE USA HELMET MODEL	ANTI-FOG CLEAR	ANTI-FOG LIGHT SMOKE	ANTI-FOG DARK SMOKE	ANTI-FOG HI-DEF AMBER	YELLOW CHROME	BLUE CHROME	CHROME
VAPOR, AIR VAPOR, VAPOR SC, VAPOR LS, CHARGER, SUPER CHARGER, DRAFT	12199901	12199902	12199903	12199904	12100905	12100906	12100908
CHAMP, DRAG CHAMP, NITRO	13199901	13199902	13199903	13199904	13100905	13100906	13100908
AIR DRAFT, AIR DRAFT DS20, DRAFT TS, I320, SUPER/EUROSPORT, FUELER	19399901	19399902	19399903	19399904	19300905	19300906	19300908
MINI-VAPOR	11399901	11399902	11399903	11399904	11300905	11300906	11300907
MINI-CHAMP	11499901	11499902	11499903	11499904	11400905	11400906	11400907

SHIELD TEAR-OFFS

Featuring a patented lamination technology, Racing Optics uses only the highest quality "optical grade" DuPont Mylar materials rather than a "packaging grade" clear polyester found in competitive tear-offs. Each package contains three stacks of 10 for a total of 30, 2-mm thick tear-offs, offering the most accurate visual acuity and low reflective properties for a distortion-free lens.

Ultra Shield brand of tear-offs are 2mm thickness each and contain 20 tear-offs per sleeve.

HELMET MODEL	RACING OPTICS	ULTRA SHIELD
VAPOR, AIR VAPOR, VAPOR SC, VAPOR LS, CHARGER, SUPER CHARGER, DRAFT	12200991	N/A
CHAMP, NITRO, DRAG CHAMP, SUPER CYCLONE	13200991	N/A
AIR DRAFT, AIR DRAFT DS20, DRAFT TS, I320, SUPER/EUROSPORT, FUELER	19300991	N/A
MINI-VAPOR, MINI-CHAMP	N/A	11420901

PIVOT KIT

Pivot kits fit all Impact helmets. Each pivot kit contains all the needed hardware for attaching your shield. Impact highly recommends this service after a few shield changes.

10000000

ALUMINUM TEAR-OFF POSTS

These aluminum tear-off posts are a great addition to any helmet. Made with a rugged one-piece aluminum design that works with any Impact shield and brand of tear-off.

10000020

DIRTGEAR BAG SINGLE HELMET

The Canvas Dirt Gear Bag features a helmet storage pocket and 5 outer pouches that vary in size. The bag also features durable handles and a detachable shoulder strap. 13"H x 32"W x 13"D. Colors: Black

PADDED HELMET BAG

Your helmet protects you. Make sure it's protected when not in use! A double-lined tear resistant nylon outer-shell and soft faux shearing liner keeps your gear safe while two easy-to-carry handles make transporting your helmet to and from the track a breeze. The Impact helmet bag offers a full-length zipper and extra space for easy helmet storage and integrated pockets provide storage for miscellaneous accessories. Colors: Black

CLAMSHELL HELMET BAG

The super-soft interior padding featured on our exclusive MCS Clam Shell bag protects your valuable helmet from scratches and dings when not in use. Manufactured from a durable, water resistant Cordura® outer shell with full zipper closure and molded rubber handle, the MCS Clam Shell bag makes protecting and transporting your helmet quick and easy. Colors: Black

DRAWSTRING HELMET SOCK

Made from a high-performance and abrasion resistant fabric, the Impact drawstring sock offers an affordable option for protecting your helmet from everyday scratches and scrapes. Designed with heavy-duty drawstring closures, the sock offers an easy way to stow and transport your helmet while keeping it safe from mishaps. Colors: Black

SHIELD BAG

Hold up to two shields in our handy carrying bag featuring a convenient divider to separate the two. Manufactured from a sturdy, yet soft, material outside and optical cloth quality interior, simply throw this inside your helmet bag or gear bag with extra shields and you are all set for the track!

Colors: Black

81500010

HELMET SUPPORT

Manufactured from high-density compression foam to provide added support and to aid in reducing neck strain, Impact's helmet support is available in Adult and Youth sizes and features a Nomex® fire retardant outer liner complying to the SFI 3.3 specification.

Colors: Black

SFI COMPLIANT
SPEC 3.3

SIZE	JUNIOR	ADULT
	74501010	74500010



Top Air Piece



Side Air Piece

AIR PIECES

Replacement Air Pieces Available

BARBED AIR ADAPTERS

Replacement Barbed Air Adapters.

TYPE	
ROUND	10000030
OVAL	10000031
90 DEGREE ROUND	10000032

HELMET DRYER

Keep your helmet dry between runs/heats with our helmet dryer. Featuring a single speed low-amp fan and rubber stripping around the base to protect surfaces, the Impact helmet dryer is a must-have item to keep the interior lining of your helmet dry and in good condition all season long.



Standard Skirt

Tapered Skirt

HELMET SKIRTS

Add valuable seconds of thermal protection while reducing wind noise to your communication system with Impact's two or three-layer helmet skirt. Available pre-installed (built-in) at the factory in your Impact helmet or as a do-it-yourself hook-and-loop attachment, our helmet skirt is manufactured from a soft knit Nomex® providing added protection from heat transfer while also reducing dirt and debris from entering the helmet. The two-layer skirt is available in our standard or tapered-in design. The tapered-in design allows the skirt to be tucked into the driving suit more easily while reducing interference between the skirt and frontal head restraint device.

SFI COMPLIANT SPEC 3.3/5 | SFI COMPLIANT SPEC 3.3/10

SKIRT TYPE	
SFI 3.3/5 - STANDARD-VELCRO ATTACHMENT	10000016
SFI 3.3/5 - TAPERED-VELCRO ATTACHMENT	10000022
SFI 3.3/10 - DRAG SKIRT STANDARD-VELCRO ATTACHMENT	10000017
SFI 3.3/5 - STANDARD-BUILT-IN FACTORY INSTALLED	10001014
SFI 3.3/5 - TAPERED-BUILT-IN FACTORY INSTALLED	10001021
SFI 3.3/10 - DRAG SKIRT STANDARD-BUILT-IN FACTORY INSTALLED	10001015

BREATH DEFLECTOR



Keep fresh air in and fumes out while minimizing fogging with our Impact helmet breath deflectors. Available for purchase individually for installation by the customer, Impact can also install a breath deflector at the factory on a new helmet or send yours in for retro-fitting.

TYPE	
SOLD SEPARATELY	10000012
FACTORY INSTALLED	10001012

REPLACEMENT RUBBER KITS

Replacement U-channel Rubber Gaskets are available for all Impact helmets. Each kit accommodates one helmet.

REPLACEMENT EYE PORT KITS

Need to replace the Kevlar® or foam around the eye port on your existing helmet? Impact recommends frequent replacement as part of your routine helmet maintenance. Shield Foam kits feature a Nomex® outer layer for added fire protection.

TYPE	
SHIELD FOAM KIT 1/4"	10000025
SHIELD FOAM KIT 1/8"	10000026
KEVLAR EYE PORT MATERIAL	10000024



Rubber Kit



Foam Kit

NECKSGEN & IMPACT REV FHR HARDWARE

Post Anchor Clips for use with Original Necksgen and new ImpactREV Devices.

TYPE		
QUICK RELEASE HELMET HARDWARE-BLACK	91000005	
FACTORY INSTALLED QUICK RELEASE HELMET HARDWARE-BLACK	91001005	

HANS POST ANCHOR CLIPS

HANS Post Anchor Clips for use with HANS Decives.

TYPE		
HANS POST ANCHOR CLIPS-PAIR	10000002	
HANS POST ANCHOR CLIPS - FACTORY INSTALLED	10001002	

IMPACT ACCEL, R-3 & D-RING CLIPS

Impact Accel Clips for use with Impact Accel Device.

D-Ring Clips for use with Helmet Tethers.

R3 Clips are used with R3 and Hybrid FHR Devices

TYPE		
ACCEL CLIPS	92000005	
ACCEL CLIPS - FACTORY INSTALLED (IMPACT HELMETS ONLY)	92001005	
D-RING CLIPS	10000011	
D-RING CLIPS - FACTORY INSTALL CHARGE (IMPACT HELMETS ONLY)	10000060	
R-3 CLIPS	10000007	
R-3 CLIPS - FACTORY INSTALED (IMPACT HELMETS ONLY)	10001007	

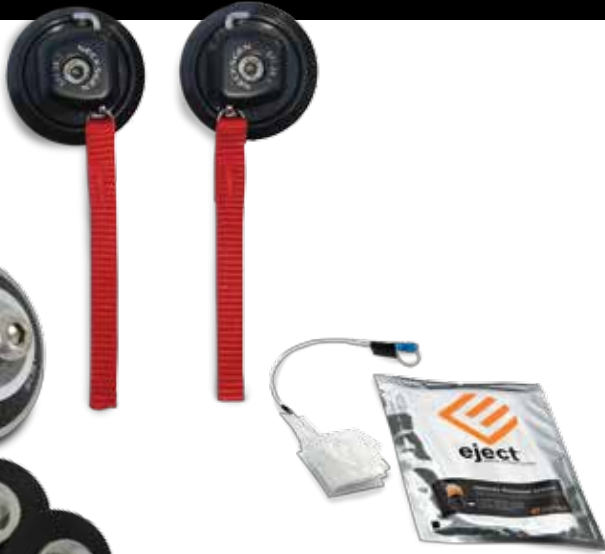

HELMET EJECT SYSTEM

The Eject System is designed to aid in the safer removal of the helmet through the use of an inflatable airbag installed in the helmet. Auto Eject System Inflation Bulb sold separately.

SYSTEM		
SYSTEM ONLY	10000008	
FACTORY INSTALLED IN HELMET	10001008	
AUTO EJECT INFLATION BULB	10000045	

IMPACT REV™ FRONTAL HEAD RESTRAINT

The foundation of the Impact REV is its patent pending Tension Neutralizing Tether design, offering superior frontal and lateral support. Through extensive testing, it was determined the yoke added unnecessary mass to the device, limited the driver's range of motion, and made ingress and egress from the race vehicle difficult. The single tension neutralizing tethering system does all the work, allowing the yoke to be eliminated for a significant weight reduction while minimizing interference between the seat and helmet.

Weighing in at just over a pound and featuring a quick eject release, the Impact REV exemplifies simplicity and ease. The REV is engineered to rest comfortably on the Trapezius muscles rather than the Clavicles, and allows for an impact to be evenly diffused amongst the multiple load paths designed into the single tension neutralizing tethers. The patent-pending design of the REV also reduces the incidence of impact and stress related injuries to the chest or collarbones through the elimination of the interfering yoke and a reduction in the device's mass.

Do you compete in various forms of motorsports? The ergonomic design of the Impact REV eliminates the need to own various devices simply because you have differing seat angles. Available in three sizes (small, medium, and large). Additional features include a quick release system, allowing for a quick eject of the tethers from the helmet and integrated belt guides ensure the restraints stay put. The Impact REV is manufacturer's certified to the SFI 38.1 specification, so it will also meet the Frontal Head Restraint requirement outlined by most racing sanctioning bodies.



SIZE	
SMALL	91000027
MEDIUM	91000026
LARGE	91000025

- Manufacturer's Certified to the SFI 38.1 Specification
- Patent-Pending Tension Neutralizing Tether Design for Superior Lateral & Frontal Support
- Lightweight - Unnecessary Mass was Eliminated; Unit Weighs Just Over One Pound
- Comfortable - No Interfering Yoke and also Features Padded Comfort Foam
- Design - Allows for Quick Ingress and Egress from Race Vehicle
- Ergonomic - Revolutionary Design Allows for Little to No Interference with Seat & Helmet
- Superior Construction - Manufactured from DuPont's Carbon Fiber Composite Materials for Strength
- Only Need One Device - Impact REV Works in Any Race Car and With Every Seat Angle
- Three Sizes Available for the Perfect Fit (Small, Medium, and Large)



Ear Cups

HELMET EAR CUPS

New! Impact's line of noise-canceling ear cups are manufactured from a cushioned comfort PVC foam and can be used to seal out ambient sounds (even while wearing ear buds) or can be fitted with integrated speakers. The Impact Ear Cups can be factory installed into any Impact helmet.

EAR CUPS		
FACTORY INSTALLED IN NEW HELMET (NO WIRING)	10000068	
FACTORY INSTALLED & WIRED WITH SPEAKERS	*Refer to Radio Wiring or Call for Details	*Refer to Radio Wiring Kits



Standard Style Cheek Pads

STANDARD CHEEK PADS

Are your standard cheek pads a little too tight or a little too loose? Offered in a variety of thicknesses and configurations, Impact's full line of helmets feature an interchangeable cheek pad for a customized and perfect fit. Ranging from thin, standard and thick options with a Velcro® attachment for fast changes, our exclusive interchangeable cheek pads are lined with soft knit Nomex® for added comfort. Sizes: Thin/Standard/Thick



V-Style Cheek Pads

V-STYLE CHEEK PADS

Do your radio communication buds add pressure to your ears inside your helmet? Impact offers the ideal solution for this common problem with the introduction of our V-style cheek pads specially designed to relieve padding pressure caused by ear buds. Available in thin, standard, and thick options our exclusive V-style cheek pads install quickly and easily with Velcro® attachment. Sizes: Thin/Standard/Thick



Ear Cup Cheek Pads

EAR CUP CUT-OUT CHEEK PADS

If you are running Impact's noise cancelling/speaker ear cups and require a different thickness cheek pad then look no further! Available in thin, standard, and thick options our exclusive Ear Cup cheek pads install quickly and easily with Velcro® attachment. Sizes: Thin/Standard/Thick



HELMET MODEL	THIN	STANDARD	THICK	V-STYLE THIN	V-STYLE STANDARD	V-STYLE THICK	EARCUP THIN	EARCUP STANDARD	EARCUP THICK
VAPOR, AIR VAPOR, VAPOR SC, VAPOR LS, CHARGER, SUPER CHARGER, CHAMP, DRAFT	11111121	11111122	11111123	11111124	11111125	11111126	11111137	11111138	11111139
1320, SUPER/EUROSPORT, DRAFT TS, AIR DRAFT	11111131	11111132	11111133	11111134	11111135	11111136	11111137	11111138	11111139
VELOCITY, RALLY-X	11111151	11111152	11111153	n/a	n/a	n/a	11111154	11111155	11111156
MINI-VAPOR & MINI-CHAMP	11111141	11111142	11111143	n/a	n/a	n/a	n/a	n/a	n/a



NECK SIZE

3.0"	3.5"	4.0"	4.5"	5.0"	5.5"	6.0"
------	------	------	------	------	------	------

SMALL MEDIUM LARGE

MEASURE THE DIAMETER OF YOUR NECK JUST ABOVE YOUR SHIRT COLLAR

IMPACT ACCEL™ FRONTAL HEAD RESTRAINT

The Impact Accel offers unparalleled comfort combined with the ultimate in frontal and angular impact protection. Utilizing a single self-neutralizing tether system, the Impact Accel device distributes stress under impact through four paths providing an equal distribution of forces while also offering a full range of head motion. Weighing just a mere 1.8 pounds, the Impact Accel features unique body-forming shoulder pads minimizing pressure points on the collarbones and significantly improving comfort. Constructed from lightweight, yet durable, DuPont carbon composite material, the design and choice of materials allows the device to flex in unison with the body, thus minimizing driver fatigue and ensuring your device can withstand the rigors of racing. Adjustable from 10° – 40°, the Impact Accel is your go-to safety device regardless of seat angle or complement of motorsports.

SFI COMPLIANT
SPEC 38.1

MADE IN THE
USA

SIZE	
STANDARD SIZE w/QUICK-RELEASE & D-RING	92000499

- Manufacturer's Certified to the SFI 38.1 Specification
- Adjusts Between 10-40 Degrees for a Variety of Uses
- Weighs Less than 2 Pounds (1.8 Pounds or 816.5 Grams)
- Body Forming Shoulder Pads offer Unparalleled Comfort
- Allows for Quick Ingress and Egress from Race Vehicle
- Offers Superior Angular Impact Protection & SFI 38.1 Compliant
- Manufactured from DuPont® Carbon Fiber Composite Materials
- Includes Helmet Hardware, No Need to Purchase Separate FHR Posts for Your Helmet

The thing I love about off-road racing is the pride in how abusive it is.
- Jimmie Johnson

- The Standard Size Accel FHR fits Most Adults, Typically a Driver Over 100 Pounds
- No Special Tools Needed, the Accel uses Standard Tools, We Even Include a Tool Kit
- Tethers are Preset for the Best Protection, No Need for Annoying Tether Adjustments
- Works with Both 2-inch and 3-inch Shoulder Belts
- Helmet Hardware Will Directly Work with Snell SA2015 and SAH2010 Helmets with No Drilling or Modifications Necessary. Easy-to-follow Instructions are Included with the Accel to use the Hardware with Undrilled SA2010 Helmets
- Padded Carrying Case Included

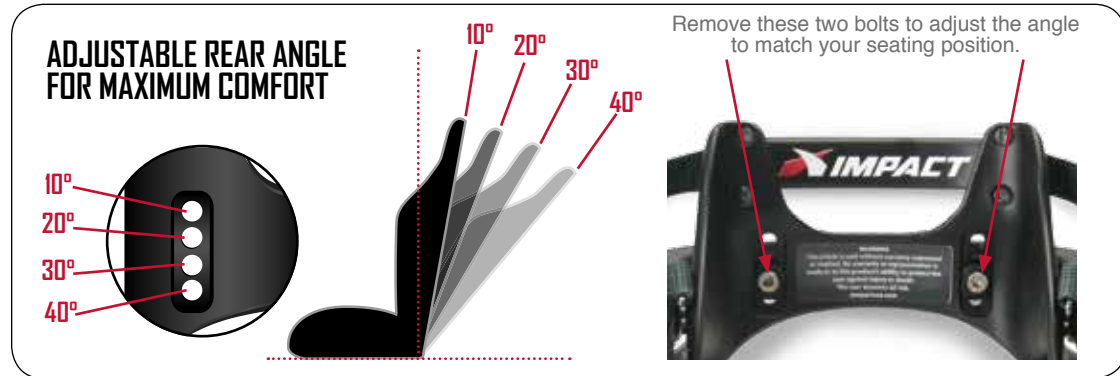

SFI 38.1 RECERTIFICATIONS / FHR SERVICE

LEVEL OF SERVICE	
LEVEL 1 - INSPECT AND REPLACE SFI TAG	
LEVEL 2 - INSPECT, REPLACE SFI TAG AND REPLACE TETHER SYSTEM	
LEVEL 3 - INSPECT, REPLACE SFI TAG, REPLACE SHOULDER PADS AND TETHER SYSTEM	

Tension Neutralizing Tether: Using a single self-neutralizing tether, the loads under impact are distributed through four different load paths. This unique system offers an equal distribution of forces under impact. This system also offers a full range of head motion and side and angular impact protection.

Quick Release Helmet Hardware: This is a unique two finger quick eject helmet attachment system.

Emergency Pull: Optional pull tag for quick disconnect.

Wings: Standard adult unit can accept 2" or 3" seat belts. The wings aid in keeping your harness in place under impact. Even in multiple impact situations where the belts could loosen.

Flexible Bar: This allows for upper body movement and comfort while driving. Also allows user to flex the unit over larger necks.

Belt Guides: The guides keep the unit centered on the driver at all times, not allowing the unit to slip from under the belts.

Body Forming Pads: The body forming Kevlar® belts with Nomex® pads fit under the seat belt, therefore taking any pressure off the collar bone and making the unit very comfortable.

Low Rear: The low profile design allows easy access from confined areas with little interference on roll bars in dragsters and landspeed cars.

Adjustable Rear: The unit is adjustable to fit most seat angles from 10°-40°. This also allows the driver to adjust the back of the unit for comfort or interference with the helmet or the seat.

NECK SIZE

13"	14"	15"	16"	17"	18"	19"
-----	-----	-----	-----	-----	-----	-----

MEASURE THE DISTANCE AROUND YOUR NECK JUST ABOVE YOUR SHIRT COLLAR

Dr. Wilfred Sweeny and Dr. Wayne Sorenson are not exactly household names, however the invention they have been credited with developing certainly is! While working for DuPont's Textile Engineering lab Dr. Sweeny discovered and engineered a high-molecular-weight product that could be spun into a tough crystallizable fiber offering outstanding thermal and flame resistance. Soon after this discovery, Dr. Sorenson developed a method to achieve mass production and commercialization of the product we now know as Nomex®. This important and revolutionary invention provides much needed thermal protection for thousands of men and women serving worldwide in the armed forces, our hometown heroes fighting fires, and also offers valuable additional seconds of fire protection to racers in all forms of motorsports whether competing in grassroots local events or at the professional level.

Nomex® vs. Treated Cotton Fabrics

Not all fire resistant fabrics are the same! While your budget may be the biggest determining factor in which driving suit you ultimately purchase, the fabric and construction of the garment should also be given equal consideration. The quality of materials and their thermal properties can vary as drastically as the price.

• **Treated Cotton Fabrics:** Treated suits are manufactured from cotton that has been chemically treated with a compound that bonds to the fabric making it fire-retardant. The drawbacks of this treated fabric is the life expectancy of the fire-retardant treatment is limited due to the chemical used to treat the fabric diminishes with each wash or dryclean. Unfortunately, the efficacy of the garment's retardant properties are unknown simply by looking at the suit. Impact does not recommend or manufacture our driving suits from treated cotton fabrics.

• **Nomex® Fabrics:** Driving and Crew suits manufactured from Nomex® are inherently flame resistant, meaning that the exceptional thermal and flame protection provided by Nomex® cannot be washed out or worn away. Nomex® also will not sustain combustion in air or melt when exposed to flame. Because Nomex® carbonizes and becomes thicker when exposed to intense heat; it forms a protective barrier between the heat source and the skin. This unique reaction to intense heat provides valuable escape time when fires occur and helps protect wearers against them.

Suit Layers and SFI Ratings

One of the most effective ways to enhance personal safety on the track or in the pits is to increase the number of Nomex® layers your suit is manufactured from. A two or three-layer suit is far more resistant to flame and heat transfer and will provide you with valuable additional seconds of time during an emergency situation versus a single-layer suit. Additional protection can also be obtained by wearing Nomex® under garments beneath the driving or crew suit as well as a balaclava and Nomex® socks.

Suit Specifications - SFI Specification & FIA Homologation Program

The SFI Foundation and the FIA (Fédération Internationale de l'Automobile) are both non-profit organizations that issue and administer standards for motorsports related equipment. The SFI Foundation is based in the U.S.A and is recognized by racing organizations such as NHRA and NASCAR. The SFI Foundation standards are often adopted as the rules for safety by racing organizations that participate in the SFI Foundation's specification program. The FIA is a European based association that not only issues safety standards for international race cars and equipment, but also governs over international motorsports events as well.

The purpose of a unified set of standards and criteria is to establish recognized levels of quality in motorsports equipment and ensure the overall safety of the racing industry. The consumer benefits from manufacturers that cooperate with the specification programs as there is an established and expected level of performance for the products. Impact proudly and voluntarily participates in both the SFI and FIA specification programs. Both SFI and FIA have certain criteria relating to driving suits and their construction, the materials used, tensile strength, heat transmission, and the garment's thermal resistance.

SFI Ratings Explained

The SFI Foundation's Driver Suit Specification 3.2A tests a garment's fire-retardant capabilities and also details specific garment construction and performance characteristics. The spec contains a rating system based on the garment's ability to provide Thermal Protective Performance (TPP) in the presence of both direct flame and radiant heat. The purpose of the TPP is to measure the length of time the person wearing the garment can be exposed to a heat source before incurring a second degree, or skin blistering burn. There are various sub categories (which refer to the garment's TPP ratings – "Thermal Protective Performance") for the 3.2A specification. The TPP rating is the product of exposure heat flux and exposure time. The TPP results can be converted to the time before a second-degree burn occurs. The higher the garment rating, the more time before a second-degree burn.

SFI Rating	TPP Value	Time to 2nd Degree Burn
3.2A/1	TPP 6	3 Seconds
3.2A/3	TPP 14	7 Seconds
3.2A/5	TPP 19	10 Seconds
3.2A/10	TPP 38	19 Seconds
3.2A/15	TPP 60	30 Seconds
3.2A/20	TPP 80	40 Seconds



A driving or crew suit with an SFI specification label 3.2A/1 will most likely be a single-layer suit and only accepted in the entry-level and grassroots racing organizations. The most commonly required specification by racing sanctions is SFI's 3.2A/5 rated driving suits. Impact offers a full-line of budget-friendly off-the-shelf driving suits manufactured to the SFI Foundation's 3.2A/5 specification. Constructed from Futura Nomex® our 2-layer Racer suit offers many of the comfort and convenience features found on much higher priced and custom suits and is the ideal choice for drivers not wanting to sacrifice comfort and quality because of price. Impact's Custom suits offer style and comfort with our exclusive line of 2-layer lightweight sateen Nomex® and honeycomb moisture-wicking inner liner. Additional creature comforts such as stretch gusseting along the lower back panel and 360° floating sleeves add mobility while making these two suits affordable and stylish.

Are you running an alcohol or Nitro-powered drag car? Chances are your racing sanction will require you to wear a suit manufacturer's certified to the 3.2A/15 or 3.2A/20 standard. Impact has you covered with our off-the-shelf line of Team Drag suits, constructed as a two-piece (jacket and pants). Available by special order, Impact can also manufacture Team Drag suits to the SFI 3.2A/20 specification or if you are looking for something a little more custom, Impact's sales and art department can work with you to create a suit to meet your needs.



Continuous research, development and testing is conducted by Impact on materials and sewing methods to perfect what may be the most under-rated piece of driver's safety equipment. Impact creates each race suit with style and appearance in mind while focusing on the ultimate goal: Safety. We understand that each driving suit that leaves our factory in the heart of Gasoline Alley in Indianapolis, Indiana, has the potential to save a life. We also understand that each driver prefers their suit to be built to their exacting standards. With a wealth of driver feedback, including Impact owner Robbie Pierce, who tests his products to the limits during the grueling Baja 1000, we take every detail into account when designing a suit. No driver will have to "tough it out" for multiple heat races and a main or a 500-mile trek through the Baja desert. Though safety and comfort are Impact's main priority, a driving suit is more than a protective cover between a driver and a potential disaster; every driver wants to look their best on the podium. When you look good, we look good, and Impact is dedicated to continuously researching methods to improve our comfort, styling and options to promote the best practices in safety performance.

WHAT GOES INTO YOUR FULL CUSTOM SUIT



FIRESUIT SIZING

Size:	Height	Weight (lbs.)	Chest	Waist	Hips	Torso	Inseam
ADULT SMALL	5' 4" - 5' 6"	130 - 150	38" - 40"	29"	33"	27"	31"
ADULT MEDIUM	5' 6" - 5' 8"	150 - 170	42" - 44"	32"	36"	28"	31"
ADULT LARGE	5' 8" - 5' 10"	170 - 190	46" - 48"	36"	40"	29"	32"
ADULT EXTRA LARGE	5' 10" - 6' 1"	190 - 210	50" - 52"	39"	44"	31"	33"
ADULT XXL	6' - 6' 2"	220 - 240	54" - 56"	44"	47"	32"	33"
JUNIOR SMALL	4' 1" - 4' 4"	50 - 65	27" - 29"	23"	26"	19"	22"
JUNIOR MEDIUM	4' 3" - 4' 7"	70 - 90	28" - 30"	25"	27"	21"	25"
JUNIOR LARGE	4' 5" - 4' 9"	80 - 100	34" - 36"	27"	31"	23"	27"
JUNIOR EXTRA LARGE	4' 7" - 4' 11"	90 - 120	35" - 37"	28"	32"	25"	29"

CUSTOM DRIVER SUITS

PREMIUM ONE OR TWO-PIECE SFI 5/FIA DRIVER SUITS

Imagine entering turn one at the Indianapolis Motor Speedway and hitting 228mph along the front stretch during the Indy 500, or accelerating to hit 325mph in just under four seconds during a quarter mile run in a Top Fuel Dragster at the Winter Nationals. Imagine racing through the deepest trenches of the Baja desert in a state-of-the-art Trophy Truck at 115mph in the pitch dark, with no assistance in sight for miles and trusting the landscape and obstacles are the same as when you pre-ran that section a few days ago. Now imagine competing in these extreme motorsports in uncomfortable and ill-fitting safety equipment. No fun, right?! Extreme racing environments require uniquely designed products to keep your mind focused on the task at hand: Winning. At Impact, we understand how safety, comfort and style need to work together to create a product that not only fits and performs but also looks good too. Our knowledge of driver comfort is why drivers such as IndyCar's Tony Kanaan, NHRA's Antron Brown and Matt Hagan, and off-road racing's Robby Gordon and Rob MacCachren choose Impact. Impact's line of custom handcrafted fire suits are a result of years of professional driver feedback and feature numerous integrated creature comforts. Available in a variety of colors and fabric choices offering the ultimate in flexible, breathable and moisture-wicking comfort, Impact's suits are manufactured in the heart of Gasoline Alley in Indianapolis, Indiana from our exclusive line of Nomex® material imported from Europe. Custom-fitted to your exacting measurements and embroidered to include your sponsor's branding and series required logos, your Impact custom suit will not only fit and perform, it will look good on the podium too!

- Custom Suits are available manufacturers' certified to the SFI 3.2 specification as a one-piece suit, two-piece (jacket and pants), and also as a three-piece suit.
- FIA Approved suits certified to the 8856-2000 homologation are only available as a one-piece suit.



CUSTOM FIRESUIT PRICING

Suit Type	SFI Rating	TPP Rating
1-piece / 2-layer	SFI 3.2A/5	Over TPP 19
2-piece / 2-layer	SFI 3.2A/5	Over TPP 19
1-piece / 3-layer	SFI 3.2A/5	Over TPP 28
2-piece / 3-layer	SFI 3.2A/5	Over TPP 28
1-piece / FIA 2-Layer	FIA 8856-2000 & SFI 3.2A/5	Over TPP 19
1-piece / FIA 3-Layer	FIA 8856-2000 & SFI 3.2A/5	Over TPP 28

† Base price does not include suit options, custom design, graphics or embroidery. Other charges may apply, please call our helpful sales staff for more info.

ULTRALIGHT NOMEX® FABRIC COLORS



STANDARD CUSTOM SUIT STYLES

Choose one of our "Standard" suit styles when ordering your custom suit, or speak to a sales rep to begin the process to get your very own style.

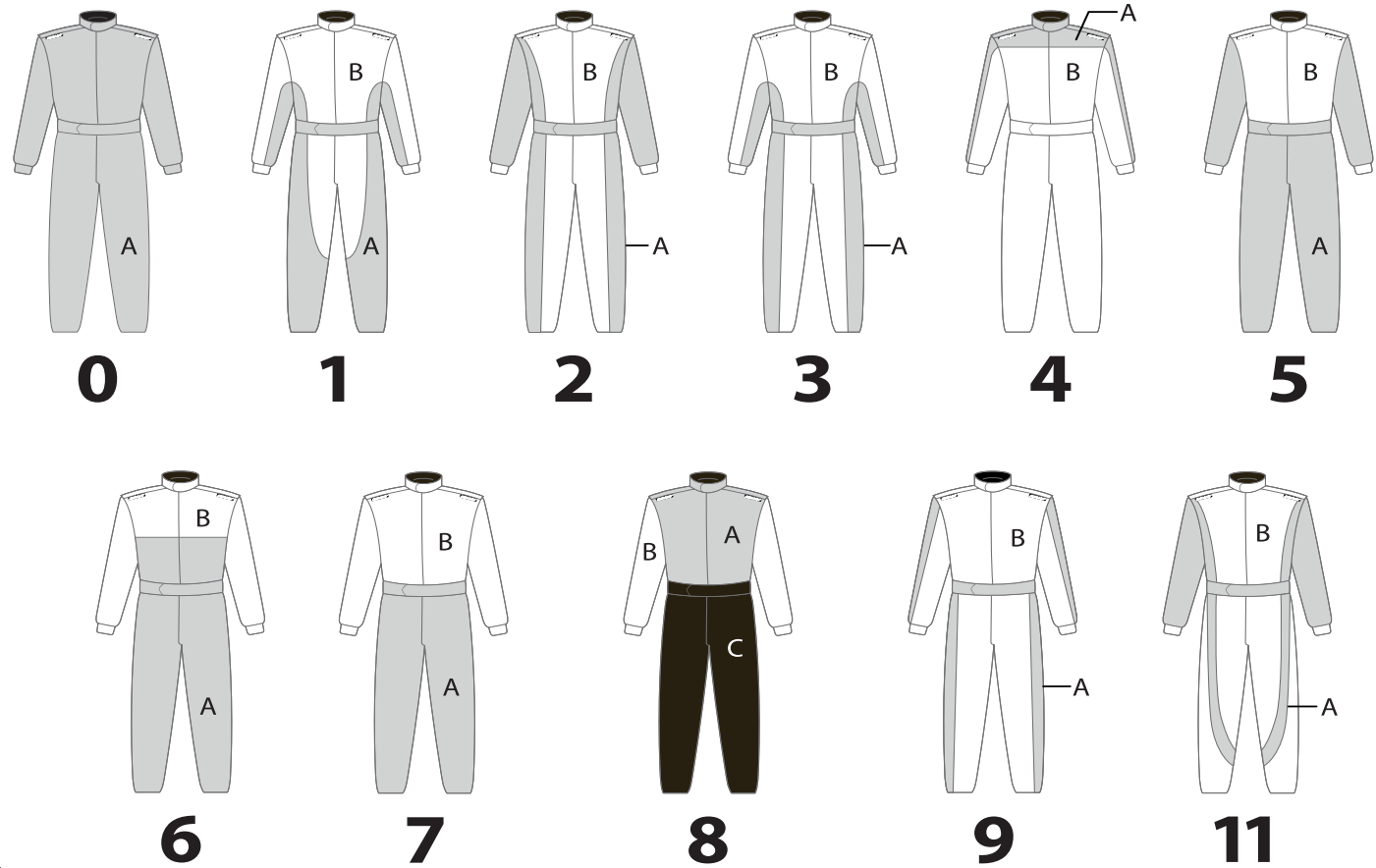

SH RACING'S GLOBAL RALLYCROSS DRIVER, NELSON PIQUET JR., CARRYING ON THE FAMILY RACING TRADITION.



RYAN SIEG, CHATTING WITH FELLOW DRIVERS, PRE-RACE AT A 2015 NASCAR XFINITY EVENT.



NASCAR CAMPING WORLD TRUCK SERIES DRIVER, RAY BLACK, JR., WITH HIS FULL CUSTOM SUIT AND CUSTOM PAINTED HELMET.



CUSTOM DRAG DRIVER SUITS

PREMIUM ONE OR TWO-PIECE SFI 15/20 DRIVER SUITS

Impact's line of custom hand-crafted fire suits manufacturer's certified to the SFI 3.2A/15 and 3.2A/20 specification are specially designed keeping in mind the unique needs of the drag racers competing at this level of motorsports. A result of professional driver feedback from top pros at Don Schumacher Racing such as Matt Hagan, Fast Jack Beckman, and Antron Brown, Impact's line of custom drag suits feature numerous integrated creature comforts such as stretch panel gusseting and floating 360° sleeves and are available in a variety of colors and fabric choices. Impact's suits are manufactured in the heart of Gasoline Alley in Indianapolis, Indiana from our exclusive line of Nomex® materials imported from Europe. Your custom suit will be fitted to your exacting measurements and can be embroidered to include your sponsor's branding and series required logos. Available as either a one-piece or two-piece (jacket and pants), Impact's line of SFI 3.2A/15 and 3.2A/20 suits offers an unparalleled level of thermal protection, comfort and styling!

SFI COMPLIANT SPEC 3.2A/15 **SFI COMPLIANT SPEC 3.2A/20** **MADE IN THE USA**

CUSTOM DRAG FIRESUIT PRICING

Suit Type	SFI Rating	TPP Rating
1-piece / drag	SFI 3.2A/15	Over TPP 60
2-piece / drag	SFI 3.2A/15	Over TPP 60
1-piece / nitro drag	SFI 3.2A/20	Over TPP 80
2-piece / nitro drag	SFI 3.2A/20	Over TPP 80

† Base price does not include suit options, custom design, graphics or embroidery. Other charges may apply, please call our helpful sales staff for more info.

ULTRALIGHT NOMEX® FABRIC COLORS



*** LTV UPGRADE**

Impact now offers all custom drag suits with the option of our LTV material featuring superior thermal performance characteristics thus allowing both the SFI 15 and 20 rated suits to be reduced by a layer, versus our Team Drag suits, while maintaining the same SFI rating and without sacrificing safety. The unsurpassed ply-bias weave of Impact's LTV multi-directional knit material carbonizes under thermal stress and direct flame forming a protective barrier of protection between the heat source and the skin. The unique weaving method of the LTV Nomex® knit also allows for breathable bi-directional airflow and moisture wicking; even under humid conditions and is the material of choice for Antron Brown and Matt Hagan.

LTV NOMEX® FABRIC COLORS



STANDARD CUSTOM SUIT STYLES

Choose one of our "Standard" suit styles when ordering your custom suit, or speak to a sales rep to begin the process to get your very own style.

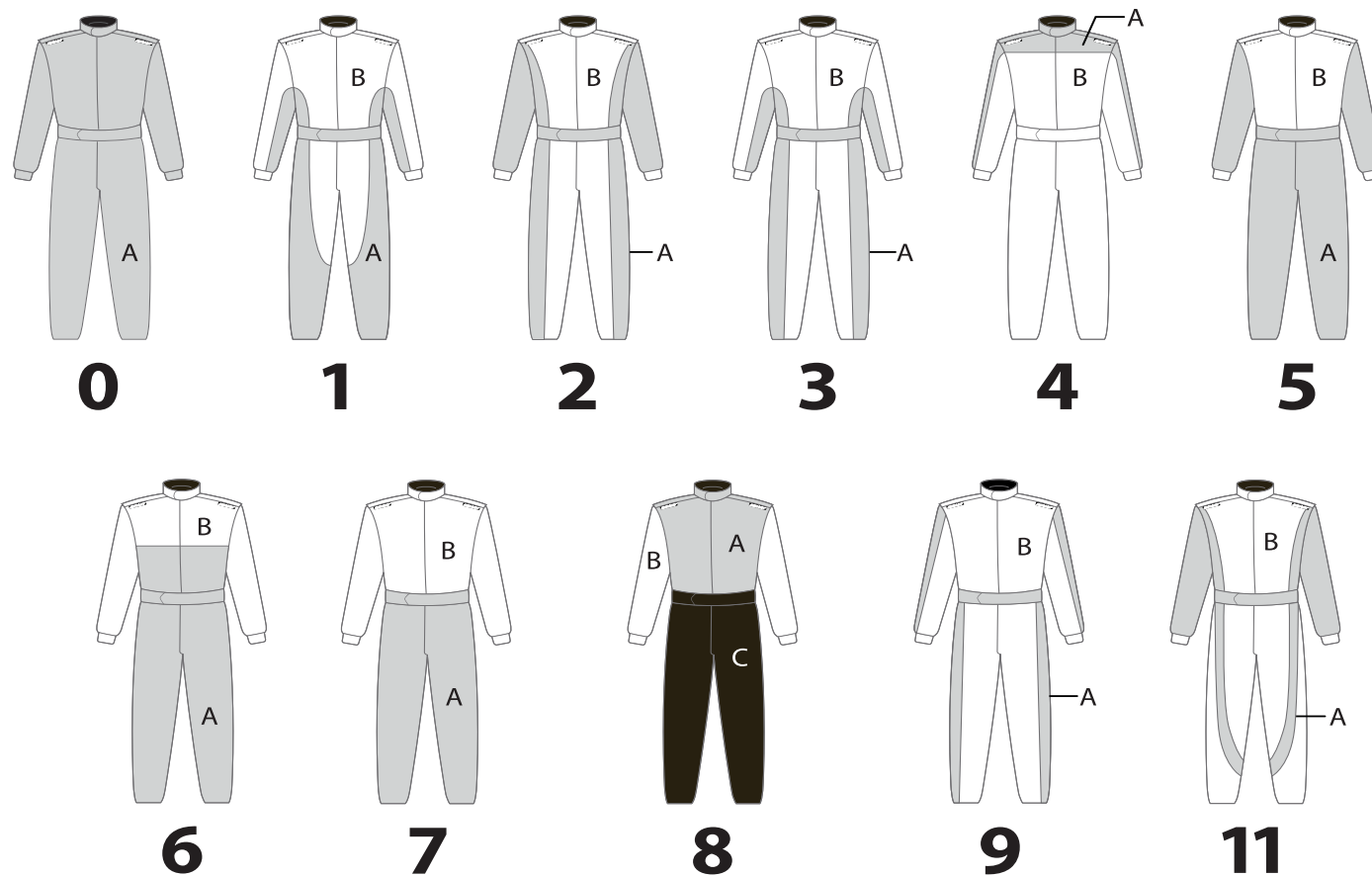

DON SCHUMACHER FUNNY CAR DRIVER JACK BECKMAN HAS ENTRUSTED IMPACT TO PROTECT HIM THROUGH THE YEARS.



ANTRON BROWN HOISTING HIS WALLY TROPHY DURING A VERY SUCCESSFUL 2015 CHAMPIONSHIP SEASON.

KB RACING'S 2-TIME NHRA PRO STOCK CHAMPION JASON LINE TRUSTS IMPACT TO SUPPLY HIS SAFETY EQUIPMENT.



ALEX RODEO MENTALLY PREPPING IN HER DODGE CHARGER FOR A RUN AT LAS VEGAS MOTOR SPEEDWAY IN THE NHRA SUMMIT SERIES.

CARBON6™ PREMIUM ONE-PIECE SFI 5 DRIVER SUIT

Impact's Carbon6 suit blends exceptional form and function with many of the must-have attributes commonly found only in custom suits. Integrating parabolic design with a unique woven carbon fiber inspired accent fabric, Impact is proud to offer the Carbon6 as our most comfortable and advanced off-the-shelf suit yet! With emphasis on driver comfort, Impact incorporated breathable anatomical stretch paneling in strategic areas for increased range of motion providing a superior performance fit. Handcrafted from lightweight sateen Nomex® fabric, the Impact Carbon6 features V-stitch quilting for exceptional thermal performance. Deep inset pockets and bootcut cuffs finish this exclusive two-layer SFI 3.2A/5 rated suit.

Adult Sizes: S/M/L/XL/2X

Colors: Black & Red/Black & Blue/Black & Gray



SIZE	BLACK W/RED	BLACK W/GRAY	BLACK W/BLUE
ONE-PIECE SUIT - SMALL	23000307	23000313	23000306
ONE-PIECE SUIT - MEDIUM	23000407	23000413	23000406
ONE-PIECE SUIT - LARGE	23000507	23000513	23000506
ONE-PIECE SUIT - EXTRA LARGE	23000607	23000613	23000606
ONE-PIECE SUIT - XXL	23000707	23000713	23000706



DYLAN HORSLEY WEARS HEAD-TO-TOE IMPACT PRODUCTS WHEN RACING HIS MINI-SPRINT ON THE WEST COAST.



NORTH-EASTERN MODIFIED DRIVER, MARC JOHNSON, GETTING READY FOR HOT LAPS IN HIS IMPACT GEAR.

THE RACER™ ONE OR TWO-PIECE SFI 5 DRIVER SUIT

The Racer has been a popular mainstay in the Impact suit lineup for many years. Recently, the Racer was updated to offer modern styling while maintaining the comfort that made previous versions of this suit so popular. Featuring a two-tone design that complements a variety of racecar wraps, the Racer is the ideal option for anyone wanting a budget-friendly, two-layer yet lightweight SFI 3.2A/5 rated driving suit without sacrificing styling, comfort, or safety. Constructed from a matte-Nomex® fabric, the Impact Racer offers anatomical stretch paneling along the lower back (lumbar) area as well as 360° full-floating arm gussets for maximum comfort and flexibility. Additional standard features include bootcut cuffs and extra deep pockets. The box quilting offers valuable additional seconds of thermal protection from heat transfer.

Adult Sizes: S/M/L/XL/2X/3X

Colors: Black/Black & Red/Black & Blue/Black & Gray



SIZE	BLACK W/RED	BLACK W/GRAY	BLACK W/BLUE	ALL BLACK
ONE-PIECE SUIT - SMALL	24215307	24215313	24215306	24215310
ONE-PIECE SUIT - MEDIUM	24215407	24215413	24215406	24215410
ONE-PIECE SUIT - LARGE	24215507	24215513	24215506	24215510
ONE-PIECE SUIT - EXTRA LARGE	24215607	24215613	24215606	24215610
ONE-PIECE SUIT - XXL	24215707	24215713	24215706	24215710
ONE-PIECE SUIT - XXXL +\$100	24215807	24215813	24215806	24215810
JACKET ONLY - SMALL	22515307	22515313	22515306	22515310
JACKET ONLY - MEDIUM	22515407	22515413	22515406	22515410
JACKET ONLY - LARGE	22515507	22515513	22515506	22515510
JACKET ONLY - EXTRA LARGE	22515607	22515613	22515606	22515610
JACKET ONLY - XXL	22515707	22515713	22515706	22515710
JACKET ONLY - XXXL +\$100	22515807	22515813	22515806	22515810
PANTS ONLY - SMALL	23315307	23315313	23315306	23315310
PANTS ONLY - MEDIUM	23315407	23315413	23315406	23315410
PANTS ONLY - LARGE	23315507	23315513	23315506	23315510
PANTS ONLY - EXTRA LARGE	23315607	23315613	23315606	23315610
PANTS ONLY - XXL	23315707	23315713	23315706	23315710
PANTS ONLY - XXXL +\$100	23315807	23315813	23315806	23315810



TEAM DRAG™

TWO-PIECE SFI 15/20 DRAG DRIVER SUIT

Impact's Team Drag line is an affordable SFI 3.2A/15 or SFI 3.2A/20 rated fire suit offering many of the same qualities found on our custom drag suits. The Team Drag jacket features built-in arm restraints and floating 360° arm gussets allowing for maximum flexibility while the Team Drag pants offer a relaxed and comfortable rise with adjustable side belts for a customized fit. The SFI-15 and SFI-20 rated Impact Team Drag is handcrafted from our high quality, lightweight imported European Nomex® and also features our exclusive ImpactMax breathable and moisture wicking inner liner for cooling comfort.

Adult Sizes: S/M/L/XL/2X

Colors: Black/Black & Red/Black & Blue/Black & Gray



SIZE	BLACK W/RED	BLACK W/GRAY	BLACK W/BLUE	ALL BLACK
SFI 15 JACKET ONLY - SMALL	29313307	29313313	29313306	29300310
SFI 15 JACKET ONLY - MEDIUM	29313407	29313413	29313406	29300410
SFI 15 JACKET ONLY - LARGE	29313507	29313513	29313506	29300510
SFI 15 JACKET ONLY - EXTRA LARGE	29313607	29313613	29313606	29300610
SFI 15 JACKET ONLY - XXL	29313707	29313713	29313706	29300710
SFI 15 PANTS ONLY - SMALL	29413307	29413313	29413306	29400310
SFI 15 PANTS ONLY - MEDIUM	29413407	29413413	29413406	29400410
SFI 15 PANTS ONLY - LARGE	29413507	29413513	29413506	29400510
SFI 15 PANTS ONLY - EXTRA LARGE	29413607	29413613	29413606	29400610
SFI 15 PANTS ONLY - XXL	29413707	29413713	29413706	29400710
SFI 20 JACKET ONLY - SMALL	29613307	29613313	29613306	29600310
SFI 20 JACKET ONLY - MEDIUM	29613407	29613413	29613406	29600410
SFI 20 JACKET ONLY - LARGE	29613507	29613513	29613506	29600510
SFI 20 JACKET ONLY - EXTRA LARGE	29613607	29613613	29613606	29600610
SFI 20 JACKET ONLY - XXL	29613707	29613713	29613706	29600710
SFI 20 PANTS ONLY - SMALL	29713307	29713313	29713306	29700310
SFI 20 PANTS ONLY - MEDIUM	29713407	29713413	29713406	29700410
SFI 20 PANTS ONLY - LARGE	29713507	29713513	29713506	29700510
SFI 20 PANTS ONLY - EXTRA LARGE	29713607	29713613	29713606	29700610
SFI 20 PANTS ONLY - XXL	29713707	29713713	29713706	29700710



REDLINE GLOVE DRAG OVER-BOOT

For our specialized Drag Gloves and Footwear please see pages 44 - 46.

QUARTER MIDGET/JR. DRAG

ONE OR TWO-PIECE SFI 5 JUNIOR DRIVER SUIT

Designed with the growing racer in mind, Impact's Quarter Midget/Junior Dragster suit is constructed from the same high-quality Nomex® material as our popular Racer suit and loaded with comfort and flexibility features such as 360° floating arm gussets and stretch knit back panel. Available in a one-piece suit or two-piece (jacket and pants), the suit also comes standard with inset pants pockets and built-in arm restraints manufacturer's certified to the SFI 3.3 specification.

Junior Sizing: S/M/L/XL

Colors: Black Only



SIZE	ALL BLACK
ONE-PIECE SUIT - SMALL	21400310
ONE-PIECE SUIT - MEDIUM	21400410
ONE-PIECE SUIT - LARGE	21400510
ONE-PIECE SUIT - EXTRA LARGE	21400610
JACKET ONLY - SMALL	22700310
JACKET ONLY - MEDIUM	22700410
JACKET ONLY - LARGE	22700510
JACKET ONLY - EXTRA LARGE	22700610
PANTS ONLY - SMALL	22900310
PANTS ONLY - MEDIUM	22900410
PANTS ONLY - LARGE	22900510
PANTS ONLY - EXTRA LARGE	22900610



MINI-VAPOR MINI-AXIS GLOVES

For our specialized Mini helmets, refer to page 18 and for our Junior gloves, refer to page 44.



If you're in control,
you're not going
fast enough.

- Parnelli Jones

JUNIOR UNDERWEAR

ARAMID UNDERWEAR

Providing valuable additional seconds of heat and thermal protection, Impact's fire retardant underwear is manufactured from our line of ImpactMAX II Nomex. Soft yet durable, our Nomex undergarments are hand-crafted with a flat interlock stitch to minimize pressure points while providing cooling comfort through the use of our exclusive moisture-wicking interlock knit charcoal gray material.



STYLE/SIZE	GRAY - IMPACTMAX II
LONG SLEEVE TOP - JUNIOR SMALL	78900313
LONG SLEEVE TOP - JUNIOR MEDIUM	78900413
LONG SLEEVE TOP - JUNIOR LARGE	78900513
LONG SLEEVE TOP - JUNIOR EXTRA LARGE	78900613
LONG BOTOMS - JUNIOR SMALL	78910313
LONG BOTOMS - JUNIOR MEDIUM	78910413
LONG BOTOMS - JUNIOR LARGE	78910513
LONG BOTOMS - JUNIOR EXTRA LARGE	78910613



CREW FIRESUITS

Promote your team and sponsors while portraying a professional and uniform appearance with Impact's line of off-the-shelf and custom crew fire suits. Looking for something quick and economical? Impact's line of off-the-shelf crew suits will meet the needs of everyone on the team with features such as reinforced seams in high-stress areas, a roomier cut for improved mobility, and deep-inset pants pockets for storage. Additional fabric wear patches, floating 360° sleeves and back panel gusseting (in the one-piece suits) provides a team uniform that is up to the challenge and works as hard as the crew. Looking for something more custom? Impact's talented art department will custom-design your over-the-wall crew's apparel to match your driving suit design or whatever you have in mind. Do you have a mid-year sponsor change and are not looking to purchase all new suits? Impact can also assist with our exclusive line of three-piece suits that keeps your crew outfitted with the latest sponsor apparel, while keeping an eye on the budget.

SFI COMPLIANT
SPEC 3.2A/5 **MADE IN THE USA**

CREW FIRESUIT PRICING *Available in standard sizes only!

Suit Type	SFI Rating	TPP Rating
OVER VEST ONLY / 2-LAYER	SFI 3.2A/5	Over TPP 19
UNDERSHIRT ONLY / 2-LAYER	SFI 3.2A/5	Over TPP 19
PANTS ONLY / 2-LAYER	SFI 3.2A/5	Over TPP 19
JACKET / 2-LAYER	SFI 3.2A/5	Over TPP 19
PANTS / 2-LAYER	SFI 3.2A/5	Over TPP 19
1-PIECE SUIT / 2-LAYER	SFI 3.2A/5	Over TPP 19

† Base price does not include suit options, custom design, graphics or embroidery. Other charges may apply, please call our helpful sales staff for more info.



RESPONDER FIRESUITS

FOR TRACKS AND SANCTIONING BODIES

Designed specifically with the needs of fire, medical, rescue and clean up crews in mind, The Responder is the first track worker safety suit custom-tailored to meet the strenuous requirements surrounding motorsports safety activities with its flexible arm gusseting and comfortable fit. Standard features integrated into each suit include deep pants pockets, extra wide belt loops for radio belts, fire-retardant reflective tape, and standard sized series and track logos (approx 4 inches). The Responder suit also includes our exclusive ImpactMax lightweight, moisture wicking inner liner and our box quilting for added thermal protection. The Responder suit is Made in the USA and is manufacturer certified to be SFI 3.2A/5 compliant.

Minimum Purchase of Six Suits Required.

SFI COMPLIANT
SPEC 3.2A/5

FUELER APRON

Designed to repel fluids, protect from fueling spills and guard against flare-ups in the pits, Impact's Fueler Apron is manufacturer's certified to comply with the SFI 52.1 specification and is constructed from a heavy-duty fire-retardant material. Featuring adjustable quick-clip neck and knee straps, Impact's Fueler Apron offers a customized and individual fit regardless of size and also offers extended leg coverings for additional thermal protection.

SFI COMPLIANT
SPEC 52.1 **MADE IN THE USA**

71200908



CREW FUELER **P2 CREW** **P3 CREW**
For our specialized Crew Helmets please see page 19.

HAILIE DEEGAN, DAUGHTER OF LEGENDARY RAGER BRIAN DEEGAN, WITH HER LUCAS OIL OFF-ROAD SERIES MODIFIED KART.



CALE COONS, USAC CHAMP JERRY COONS JR.'S SON, GETTING STRAPPED INTO HIS QUARTER MIDGET CAR. LIKE FATHER, LIKE SON. (Photo by Debi Supan)

TARGET CHIP GANASSI'S #42 CREW HANDLING BUSINESS DURING A GREEN FLAG PIT STOP AT A NASCAR SPRINT CUP RACE. (Photo by CIA Stack Photography)



EVERY SECOND COUNTS

Whether you are in the heat of the battle and setting up your car for the next turn or fueling a driver coming into a pit, a fire can happen when you least expect it. Your driving or crew suit may be the first line of protection against heat transfer and flame, but the typical two layer fire suit only provides about 8-10 seconds of protection against a second degree burn. While this amount of time may seem like forever, when you are in the "heat of the moment", fluid soaked suits can become sweltering. Fire-retardant undergarments are a second line of defense providing an additional layer of insulation against direct flame and thermal transfer. Impact highly suggests the use of fire-retardant undergarments including balaclavas, socks, and long-sleeve shirts and pants, even if these items are not required by your sanctioning body.

DRIVER/CREW UNDERWEAR

ARAMID SFI 3.3 UNDERWEAR

Gain valuable additional seconds of heat and thermal protection with the use of Impact's fire retardant base layer manufactured from our line of lightweight ImpactMAX soft-knit aramid fabric and available in a natural white or charcoal gray. Our soft yet durable fire retardant underwear is form fitting and hand-crafted with a flat interlock stitch to minimize pressure points while providing cooling comfort through the use of our exclusive moisture-wicking Aramid fabric. Available in long sleeve tops and full-length pants, Impact's works perfectly under any driving or crew suit and provides an additional layer of valuable protection.

Adult Sizes: XS/S/M/L/XL/2X/3X

* Also available in Junior Sizes for the aspiring racer in your household! See page 37.

SFI COMPLIANT SPEC 3.3

STYLE/SIZE	WHITE - IMPACTMAX	GRAY - IMPACTMAX II
LONG SLEEVE TOP - EXTRA SMALL	78400209	78700213
LONG SLEEVE TOP - SMALL	78400309	78700313
LONG SLEEVE TOP - MEDIUM	78400409	78700413
LONG SLEEVE TOP - LARGE	78400509	78700513
LONG SLEEVE TOP - EXTRA LARGE	78400609	78700613
LONG SLEEVE TOP - XXL	78400709	78700713
LONG SLEEVE TOP - XXXL +\$26	78400809	78700813
LONG BOTTOMS - EXTRA SMALL	78500209	78800213
LONG BOTTOMS - SMALL	78500309	78800313
LONG BOTTOMS - MEDIUM	78500409	78800413
LONG BOTTOMS - LARGE	78500509	78800513
LONG BOTTOMS - EXTRA LARGE	78500609	78800613
LONG BOTTOMS - XXL	78500709	78800713
LONG BOTTOMS - XXXL +\$26	78500809	78800813



SPORTSMAN UNDERWEAR

ARAMID UNDERWEAR

Gain valuable additional seconds of heat and thermal protection with the use of Impact's fire retardant base layer is manufactured from our line of ImpactMAX Aramid fabric and available in a natural white or charcoal gray. Our soft yet durable fire retardant underwear is form fitting and hand-crafted with a flat interlock stitch to minimize pressure points while providing cooling comfort through the use of our exclusive moisture-wicking interlock knit Aramid material. Our Sportsman Series fire retardant base layer is ideally suited for the grassroots racer looking for a comfortable and safer alternative for under the driving suit, and is available in short sleeve tops and shorts, Impact's fire-retardant underwear works perfectly under any driving suit and provides an additional layer of valuable protection.

* Complies with the applicable FR/TTP ratings of the SFI 3.3 specification. Adult Sizes: XS/S/M/L/XL/2X

STYLE/SIZE	WHITE - IMPACTMAX	GRAY - IMPACTMAX II
SHORT SLEEVE TOP - EXTRA SMALL	78300209	78600213
SHORT SLEEVE TOP - SMALL	78300309	78600313
SHORT SLEEVE TOP - MEDIUM	78300409	78600413
SHORT SLEEVE TOP - LARGE	78300509	78600513
SHORT SLEEVE TOP - EXTRA LARGE	78300609	78600613
SHORT SLEEVE TOP - XXL	78300709	78600713
SHORTS - EXTRA SMALL	78510209	78810213
SHORTS - SMALL	78510309	78810313
SHORTS - MEDIUM	78510409	78810413
SHORTS - LARGE	78510509	78810513
SHORTS - EXTRA LARGE	78510609	78810613
SHORTS - XXL	78510709	78810713



BALACLAVAS

ARAMID SFI 3.3 HEAD SOCKS

Available with a single or double-eye port, the Impact balaclava not only provides direct heat and thermal transfer protection for the face and neck, it also provides additional protection against smoke and fume inhalation. Manufactured from moisture wicking soft-knit Aramid fabric and handcrafted with a flat-seam interlocking stitch for enhanced comfort, the Impact balaclava is available in both natural white and charcoal gray. One size fits all.

SFI COMPLIANT SPEC 3.3



STYLE	WHITE - IMPACTMAX	GRAY - IMPACTMAX II
SINGLE-EYE	74000909	74000913
DUAL-EYE	74100909	74100913

SOCKS

ARAMID SFI 3.3 SOCKS

Manufactured from a plush-knit Aramid fabric and reinforced with Kevlar® thread, our ImpactMAX socks provide valuable additional seconds of heat and flame resistant protection and feature a flat-seam interlock construction to reduce pressure points and enhance comfort. Available in Natural White and Black

SFI COMPLIANT SPEC 3.3

SIZE	NATURAL	BLACK
MEDIUM	79000410	79999410
LARGE	79000510	79999510



Auto racing began five minutes after the second car was built.
- Henry Ford

JORDAN ANDERSON PREPPING TO RUN THE NASCAR CAMPING WORLD TRUCK SERIES AT LAS VEGAS MOTOR SPEEDWAY.





IMPACT CUSTOM CREW APPAREL
DYE-SUB SHIRTS

Promote your team and sponsors while portraying a professional and uniform appearance with Impact's dye-sublimated crew apparel. Only limited by your imagination, virtually any design can be transferred onto our high-quality shirts! Impact's talented art department will custom-design your apparel to match your title and co-title sponsor's branding, your driving suit design or whatever you have in mind. The Impact custom dye-sublimated apparel is also an ideal choice for non-race activities such as corporate and charity events, sports teams and company sales staff.

Manufactured from a choice of our popular lightweight micro-fiber, flatback breathable mesh or denier textured polyester, the Impact crew shirts also feature options such as an inset front pocket, standard or mandarin collar, and are available as a full button-down closure or quarter zip pull-over.

Minimum order: 5

Youth Sizes: S/M/L

Men's and Ladies Sizes: XS/S/M/L/XL/2X *3X/4X/5X available for an additional charge per shirt

*An Initial Artwork Proof Charge (including one proof change at no charge) will be refunded after shirt order is placed.

Advantages of Dye-Sublimation Textile Printing Methods:

- Designs, graphics and colors are only limited by the imagination
- Photograph quality printing; without the use of special techniques
- Images and designs can be printed over the entire item
- Images are permanent and can be washed
- Small minimum order amount (five) and fast turn-around

Dye Sublimation Process:

After the artwork process is finalized and approved, the desired design is reverse printed onto a coated transfer-paper using specially formulated pigment suspended liquid inks. The design is then transferred onto the fabric using a high temperature, high pressure heat press which turns the paper's ink into a gas, permeating the material and permanently solidifying the design into the fabric's fibers.

Options:

Inset Chest Pocket

Snap-Down Collar

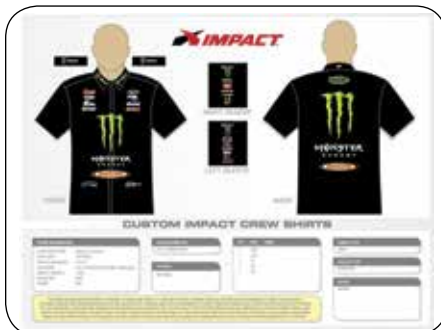

CUSTOM ARTWORK

Contact your Impact sales representative to get started on your custom-designed shirt. Our sales professionals will walk you through artwork and design ensuring a seamless order process. Our talented and experienced art department will design exactly what you are looking for, creating a professional and uniform appearance and ensuring your team gets noticed by sponsors and fans alike!



DAVID STARR AND JIMMY WELLER HANGING OUT IN THE GARAGE BEFORE A NASCAR XFINITY SERIES RACE.



ROBBIE ALLISON CARRIES ON THE FAMILY LEGACY THAT HIS GRANDFATHER, BOBBY ALLISON, AND HIS FATHER, THE LATE DAVEY ALLISON BEGAN.



ROBBY GORDON AT THE 2015 DAKAR RALLY DRIVER INTRODUCTIONS IN HIS 10TH APPEARANCE.



ALPHA™
PREMIUM SFI 5 DRIVER GLOVE

Featuring Italian-inspired design and innovation, the Impact Alpha glove offers the ultimate in driver comfort and technology. Designed with a unique parabolic pattern and single piece palm, the construction of the Alpha Glove eliminates troublesome seams and fabric bunching from the palm area. The Impact Alpha also includes a completely external seam construction reducing pressure points and abrasion, while the elastic zig-zag gauntlet closure ensures the gloves stay comfortably in place. Featuring our exclusive lightweight fire-retardant Ultra-Grip treatment and anatomically correct pre-curved patterning on the fingers, the Impact Alpha glove provides superior steering wheel grip, even during the most extreme racing environments.

Adult Sizes: S/M/L/XL
Colors: Black Only

SFI COMPLIANT
SPEC 3.3/5

SIZE	BLACK
SMALL	39000310
MEDIUM	39000410
LARGE	39000510
EXTRA LARGE	39000610



AXIS™
PREMIUM SFI 5 DRIVER GLOVE

The Impact Axis glove features a comfort-fit palm with suede insert panels for the ultimate in driver comfort and steering wheel grip. The Impact Axis glove also includes external seam construction, reducing pressure points and abrasion while the elastic zig-zag gauntlet closure ensures the gloves stay comfortably in place.

Adult Sizes: S/M/L/XL/XXL
Colors: Black Only

SFI COMPLIANT
SPEC 3.3/5

SIZE	BLACK
SMALL	35500310
MEDIUM	35500410
LARGE	35500510
EXTRA LARGE	35500610
XXL	35500710



G4™
SFI 5 DRIVER GLOVE

Manufactured from a soft knit Nomex, Impact's G4 glove features 3/4 finger seams for a perfect fit and feel. The unpadded wrap-around palm patch and split-knuckle guard provide extra comfort and abrasion resistance. The palm of the G4 glove features form-fitting suede lining for maximum grip while the cuff-style gauntlet and hook and loop closure on the upper wrist ensures the gloves stay comfortably in place over the fire suit.

Adult Sizes: S/M/L/XL (2X Black Only)
Colors: Red/Blue/Black/White

SFI COMPLIANT
SPEC 3.3/5

SIZE	BLACK	WHITE
SMALL	34013310	34013309
MEDIUM	34013410	34013409
LARGE	34013510	34013509
EXTRA LARGE	34013610	34013609
XXL	34013710	34013709



MINI-AXIS™
PREMIUM SFI 5 JUNIOR DRIVER GLOVE

The Impact Mini Axis features many of the same features as its larger counterpart including soft-knit Nomex® construction and zig zag gauntlet closure ensuring the gloves stay comfortably in place over the driving suit. Sized specifically for junior hands, the Mini Axis gloves also offer suede insert panels for superior steering wheel grip.

Junior Sizes: S/M/L/XL
Colors: Black Only

SFI COMPLIANT
SPEC 3.3/5

SIZE	BLACK
SMALL	38500310
MEDIUM	38500410
LARGE	38500510
EXTRA LARGE	38500610



REDLINE™
PREMIUM SFI 20 DRIVER DRAG GLOVE

Innovation, technology and design have come together to create Impact's newest drag glove offering both comfort and performance. Designed specifically for the drag-strip and featuring superior fire protection with its SFI rating of 3.3/20 and a TPP of over 100, the Impact Redline glove offers an anatomically correct pre-formed shape and suede insert panels on the palm and fingers allow maximum comfort and grip. The zig-zag elastic gauntlet ensures the gloves stay comfortably in place over the fire suit.

Adult Sizes: S/M/L/XL/2X
Colors: Black Only

SFI COMPLIANT
SPEC 3.3/20

SIZE	BLACK
SMALL	37500310
MEDIUM	37500410
LARGE	37500510
EXTRA LARGE	37500610
XXL	37500710



JUNIOR GLOVE SIZING

To find your glove size, measure around the largest part of your hand over the knuckles while making a fist, excluding your thumb.

Small	6"
Medium	6.5"
Large	7"
Extra Large	7.5"



ADULT GLOVE SIZING

Measurement (in)	6.5" - 7.5"	7.5" - 8.5"	8.5" - 9.5"	9.5" - 10.5"	10.5" - 11.5"	11.5" - 12.5"
European Size	8	9	10	11	12	13
US Size	Extra Small	Small	Medium	Large	Extra Large	XX Large

ADULT DRAG GLOVE SIZING

Measurement (cm)	16.5 - 19	18 - 21.5	20 - 24	23 - 26.5	25.5 - 30	29 - 33
European Size	8	9	10	11	12	13
US Size	Extra Small	Small	Medium	Large	Extra Large	XX Large

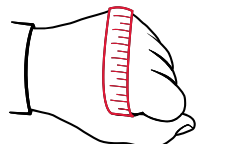

To find your glove size, measure around the largest part of your hand over the knuckles while making a fist, excluding your thumb.

H/T BOLT™
SFI 3.5/5 DRIVER SHOE

The H/T Bolt is our high-top solution for every racer. Made with our grooved sole for cooling, it provides the perfect blend of comfort, support and pedal feel for control and precision in the cockpit. Reinforced, perforated suede side and heel panels protect high-abrasion areas while allowing the multiple layers to breathe. Adjustable ankle strap and Impact's dual-lacing system make a great fit for both wide and narrow feet so it's sure to fit. The durable outer leather is backed with a plush fire-retardant interior for safety and comfort. Manufacturer's certified to the SFI 3.3/5 specification
Mens Sizes: 7/8/8.5/9/9.5/10/10.5/11/11.5/12/13/14
Colors: Black Only



SIZE	
7	46007010
8	46008010
8 1/2	46008510
9	46009010
9 1/2	46009510
10	46010010
10 1/2	46010510
11	46011010
11 1/2	46011510
12	46012010
13	46013010
14	46014010



M/T SPRINT™
SFI 3.5/5 DRIVER SHOE

The Impact M/T Sprint shoe is a mid-top racing shoe built to withstand the high temperatures and wear-and-tear of motorsports, yet is designed to have maximum comfort. The M/T employs our grooved race sole for cooling, support and precise pedal control. The dual lacing system offers a great fit for both narrow and wide feet and the M/T has a deep Achilles cut-out for maximum range of motion. A fire-retardant inner with plush padding and suede outer make this shoe comfortable and safe in all types of cars. Manufacturer's certified to the SFI 3.3/5 specification
Mens Sizes: 7/8/8.5/9/9.5/10/10.5/11/11.5/12/13/14
Colors: Black Only



SIZE	
7	47007010
8	47008010
8 1/2	47008510
9	47009010
9 1/2	47009510
10	47010010
10 1/2	47010510
11	47011010
11 1/2	47011510
12	47012010
13	47013010
14	47014010



DRAG OVER-BOOT™
SFI 3.5/20 DRIVER OVER-SHOE BOOT

Our Impact Top Fuel/Top Alcohol Over-Boot, which fits securely over Impact race shoes, is made with our high-quality Nomex® inner and outer and is designed with a full heel to calf zipper and overlock hook and loop extra-length cover. Manufacturer's certified to the SFI 3.3/20 specification
Sizes: Small (5-7)/Med (7-9)/Large (9-11.5)/ XL (11.5-13)/XXL (13-14)
Colors: Black only



SIZE	BLACK
SMALL	49000310
MEDIUM	49000410
LARGE	49000510
EXTRA LARGE	49000610
XXL	49000710



Once you've raced, you never forget it and you never get over it.
- Richard Childress

Racing harnesses play a critical role in the overall safety of a race car. The purpose of a racing restraint is to contain the occupant in the seat, while dispersing the deceleration forces across the more substantial areas of the body in order to minimize injury during a crash.

There are many different options for racing harnesses depending on the complement of motorsports and the chassis the restraints are being installed into. Five point harnesses have long been the accepted norm for many forms of motorsports (especially in grassroots racing), however as race cars get faster and the crashes more dynamic, many of the racing sanctions are requiring six and seven point restraints.

Impact offers a variety of options and restraint configurations to meet your racing needs. If you do not see your particular restraint system listed, simply give us a call and we can custom-build your restraints to your needs.

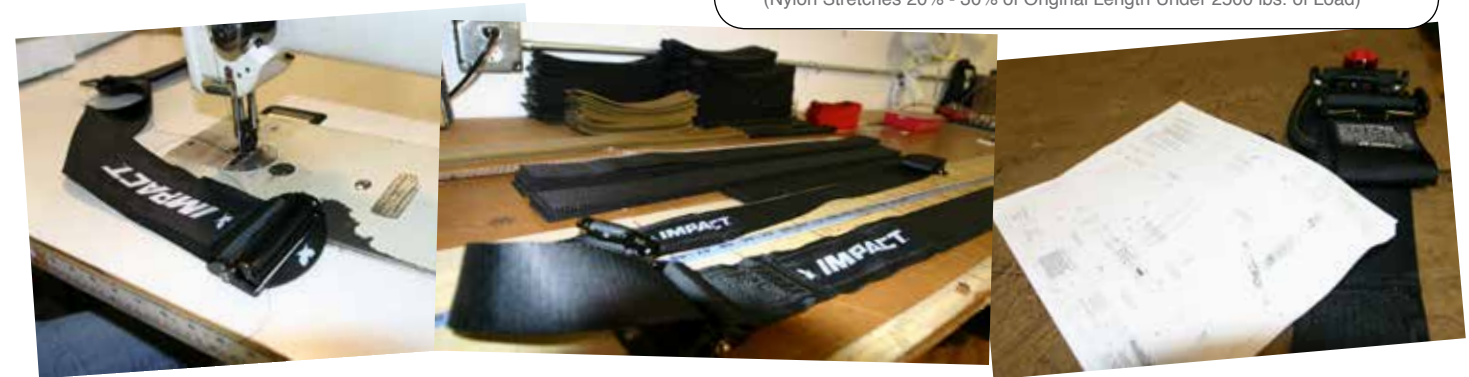

ABOUT WEBBING

The quality of the webbing used in any racing harness is a tremendously vital component and is just as important as the hardware in the overall performance and integrity of the system. Impact manufactures all of our restraints from polyester webbing due to its ability to handle a force more evenly and under a higher load with less stretching. Polyester also offers improved UV-resistance and is less susceptible to environmental degradation factors such as humidity.

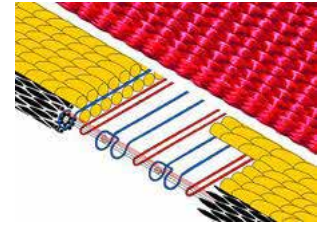

Advantages of Polyester:

- High Abrasion Resistance
- Increased Strength over Nylon
- Less Elongation (stretching) Under Load
- Resistant to Ultra-Violet Light
- Resistant to Rot and Mildew
- Offers Improved Color Fasting
- Poly Stretches 5 - 15% of Original Length Under 2500 lbs. of Load (Nylon Stretches 20% - 30% of Original Length Under 2500 lbs. of Load)

STEP ONE - LAP BELT CHOICES



STANDARD CAMLOCK
Impact's lightweight Standard camlock mechanism features a recessed quick-release rotation lever.



STANDARD LATCH & LINK
Impact's Latch and Link hardware is constructed from hardened steel for strength and reliability and features our exclusive matte black finish



ROTARY CAMLOCK
Impact's Rotary camlock mechanism is precision CNC-machined and features a no-sag faceplate design to prevent inadvertent disengagement.
**available as an option*



INTEGRATED LATCH & LINK
The Integrated latch & link lap belts feature the webbing length adjusters integrated into both the latch-side and the link-side attachment hardware creating a belt-centering, center-pull system.
**available as an option*

INDIVIDUAL

U-TYPE

V-TYPE

TRANSITION

FHR DEVICE READY
(3-inch webbing sewn over to 2-inch width)

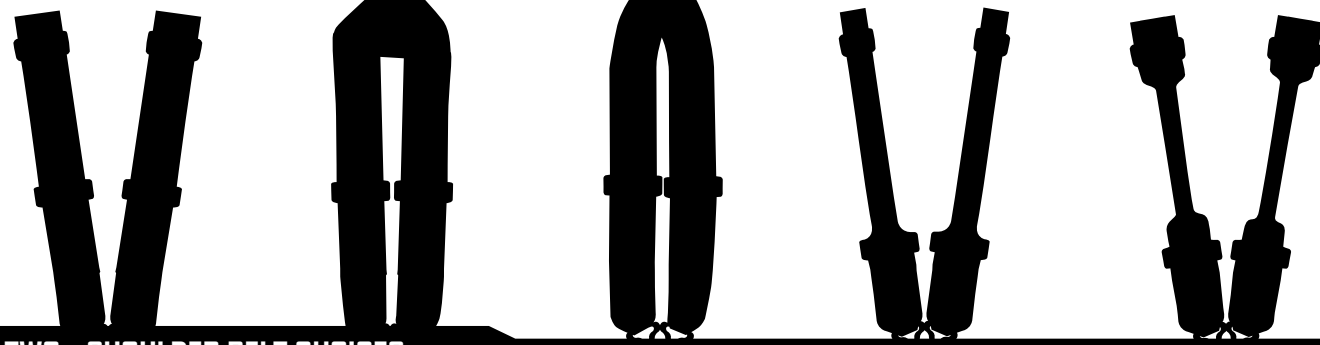

STEP TWO - SHOULDER BELT CHOICES

STEP THREE - ANTI-SUB BELT CHOICES

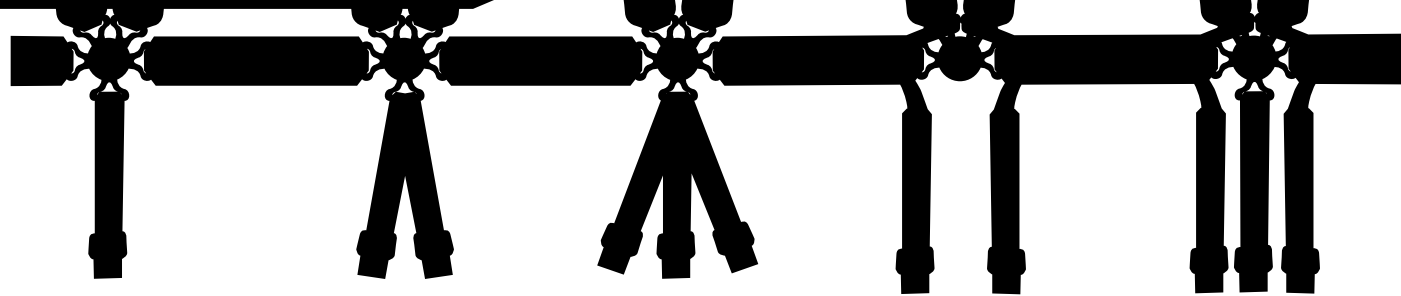

5-POINT (One Anti-Sub Belt) **6-POINT** (Two Anti-Sub Belts) **7-POINT** (Three Anti-Sub Belts) *** 6-POINT FORMULA** (Two Anti-Sub Belts) *** 7-POINT FORMULA** (Three Anti-Sub Belts)

FORMULA SUBS

All Impact anti-sub belts include three-bar hardware for adjustment to the fixed length of the belt. On Formula-style restraints, the anti-sub straps are routed through D-rings sewn onto the lap belts eliminating the sub straps from interfering with the driver's legs and pelvis providing increased comfort.

The anti-sub belt(s) play a critical role in the overall effectiveness of a restraint system. The purpose of the anti-sub belt(s) is to maintain the position of the lap belt; ensuring it stays low and tight on the pelvis during an accident and keeps the body from sliding below the lap belt. Containing the pelvis and minimizing the incidence of submarining also reduces the resultant impact load to the head, neck and chest. When the pelvis and body is appropriately contained the deceleration forces are dispersed across the more substantial areas of the body, reducing the incidence of injury.



RATCHET STYLE ADJUSTER

Available as an option on any of the Impact three-inch 16.1 SFI rated lap belts, Impact's Ratchet adjuster is manufactured from a heat-treated chromoly steel and features a double locking mechanism for added safety. The ratcheting mechanism can be specified for either left or right side use and features a bolt-in installation on the mechanism side while the opposing side features the standard three-bar wrap or bolt-in option (available with clip-in installation as well). The ratcheting mechanism replaces one of the standard lap adjusters (left or right, depending on your preference) allowing the belt to be quickly and easily tightened without the need for outside crew assistance. Impact's ratchet style adjuster is only available with the purchase of a complete set of restraints. The ratcheting system will not be sold individually or with the purchase of a lap belt only. The mechanism uses a 1/4-inch drive ratchet (not included).

BOLT-IN WITH 3-BAR

All Restraint Systems feature Bolt-In end hardware and also include a 3-bar adjuster for wrap installation. Clip-in end hardware available as an option.

END HARDWARE

Impact offers additional end hardware options if your installation requires something other than the standard Bolt-in ends. Sold as individual pieces or can be specified on your custom restraint order.

QSR ADJUSTER

Offered standard on all Impact shoulder harnesses, our QSR adjuster offers quick and easy adjustment by simply flipping up the lever and pulling down on the shoulder harness end.



Bolt-in
50000021



Clip-in
50000031



3-Bar (wrap)
50000011



Eye-Bolt
50000041



SFI COMPLIANT
SPEC 16.1

SFI COMPLIANT
SPEC 16.5

STOCK CAR RESTRAINTS

Impact's Stock Car Style restraints offer the ultimate in comfort with formula-style anti-sub belts and our lightweight CNC machined camlock closure, making them the belt of choice for Ron Hornaday.

3-inchx3-inch
CAMLOCK RESTRAINTS

Manufacturer's Certified to SFI 16.5.

3-inch Lap x 3-inch Indiv. Shoulders; Camlock - SFI 16.5 *includes Bolt-In Ends and Three-Bar for Wrap	7 Point Formula
Pull-Down Right Lap; Fixed Left Lap (adjuster only on right side)	55362116
Pull-Up Right Lap; Fixed Left Lap (adjuster only on right side)	(A) 56362116



(A) 56362116 Shown

TOP FUEL/NITRO RESTRAINTS

Impact's Nomex covered restraints are the choice of drag champions, Tony Schumacher, Antron Brown and Matt Hagan. The 2-inch webbing** offers superior containment as it seats into the natural crest of the hip-bone more naturally and works in harmony with the 7-point formula style set-up to reduce submarining.

2-inchx2-inch
CAMLOCK RESTRAINTS w/NOMEX®

Manufacturer's Certified to SFI 16.5.

2-inch Lap x 2-inch Indiv. Shoulders - SFI 16.5 *includes Nomex® Covering & Bolt-In Ends and Three-Bar for Wrap	7 Point Formula
Pull-Up Both Laps (adjuster on right and left side)	(B) 58362229



(B) 58362229 Shown

DIRT TRACK RESTRAINTS

Impact's 2-inch dirt-track style restraints are the belt of choice for championship Sprint and Midget Car racer, Jerry Coons, Jr. Featuring Impact's exclusive lightweight matte-black hardened steel latch-and-link hardware and polyester 2-inch webbing, these restraints can withstand a full season of dirt-track abuse.

2-inchx2-inch
LATCH & LINK RESTRAINTS

Manufacturer's Certified to SFI 16.1.

2-inch Lap x 2-inch Indiv. Shoulders - SFI 16.1 *includes Bolt-In Ends and Three-Bar for Wrap	5 Point
Pull-Down Left Lap; Fixed Right Lap (adjuster only on left side)	(C) 51115222



(C) 51115222 Shown

OFF-ROAD & DESERT RACING RESTRAINTS

Impact's 3-into-2-inch transition harnesses with our Ratchet Adjuster are the restraints of choice for off-road racing champions such as Robby Gordon and Rob MacCachren. Featuring frontal head restraint device ready shoulder harnesses and a ratchet adjuster, these off-road racing belts provide ease of adjustment throughout the race.

3-inchx3 into 2-inch
TRANSITION
LATCH & LINK RESTRAINTS
w/RATCHET ADJUSTER

Manufacturer's Certified to SFI 16.1.

3-inch Lap x 3-inch to 2-inch Transition Indiv. Shoulders - SFI 16.1 *includes Clip-In Ends and Three-Bar for Wrap	5 Point
Pull-Down Both Laps (adjuster on right and left side) Ratchet Adjuster on Left Side	(D) 53115239
Pull-Down Both Laps (adjuster on right and left side) Ratchet Adjuster on Right Side	53111239



(D) 53115239 Shown

Manufacturer's Certified to the SFI 16.5 Specification

SFI COMPLIANT
SPEC 16.5



(B) 56362236 Shown



(A) 56362116 Shown

3-INCH x 3-INCH CAMLOCK RESTRAINTS

Manufacturer's Certified to SFI 16.5.

3-inch Lap x 3-inch Indiv. Shoulders; Camlock - SFI 16.5 <small>*includes Bolt-In Ends and Three-Bar for Wrap</small>	5 Point	6 Point	7 Point Formula
Pull-Down Right Lap; Fixed Left Lap (adjuster only on right side)	55342116	55352116	55362116
Pull-Up Right Lap; Fixed Left Lap (adjuster only on right side)	56342116	56352116	(A) 56362116

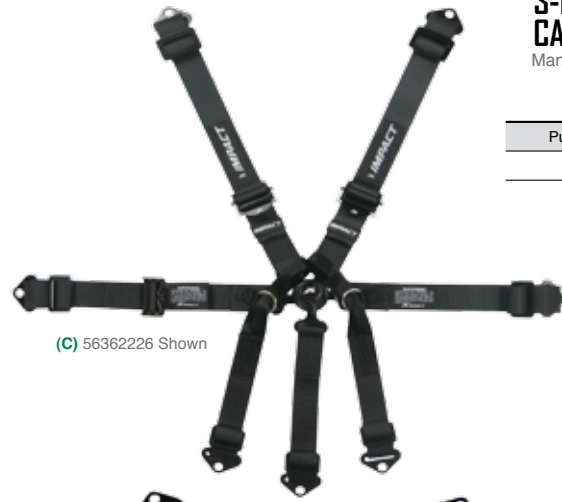

(C) 56362226 Shown

3-INCH x 3 into 2-INCH TRANSITION CAMLOCK RESTRAINTS

Manufacturer's Certified to SFI 16.5.

2-inch Lap x 3-inch to 2-inch Transition Indiv. Shoulders - SFI 16.5 <small>*includes Bolt-In Ends and Three-Bar for Wrap</small>	6 Point	7 Point Formula
Pull-Down Right Lap; Fixed Left Lap (adjuster only on right side)	55352236	55362236
Pull-Up Right Lap; Fixed Left Lap (adjuster only on right side)	56352236	(B) 56362236

2-INCH x 2-INCH FORMULA CAMLOCK RESTRAINTS

Manufacturer's Certified to SFI 16.5.

2-inch Lap x 2-inch Indiv. Shoulders - SFI 16.5 <small>*includes Bolt-In Ends and Three-Bar for Wrap</small>	7 Point Formula
Pull-Down Right Lap; Fixed Left Lap (adjuster only on right side)	55362226
Pull-Up Right Lap; Fixed Left Lap (adjuster only on right side)	(C) 56362226

2-INCH x 2-INCH CAMLOCK RESTRAINTS

Manufacturer's Certified to SFI 16.5.

2-inch Lap x 2-inch Indiv. Shoulders - SFI 16.5 <small>*includes Bolt-In Ends and Three-Bar for Wrap</small>	6 Point
Pull-Down Right Lap; Fixed Left Lap (adjuster only on right side)	55352226
Pull-Up Right Lap; Fixed Left Lap (adjuster only on right side)	(D) 56352226



(D) 56352226 Shown

Manufacturer's Certified to the SFI 16.5 Specification

SFI COMPLIANT
SPEC 16.5



(A) 51122116 Shown



(B) 51122226 Shown

3-INCH x 3-INCH LATCH & LINK RESTRAINTS

Manufacturer's Certified to SFI 16.5.

3-inch Lap x 3-inch Indiv. Shoulders; Latch & Link - SFI 16.5 <small>*includes Bolt-In Ends and Three-Bar for Wrap</small>	5 Point	6 Point
Pull-Down Right Lap; Fixed Left Lap (adjuster only on right side)	(A) 51122116	51122116
Pull-Up Right Lap; Fixed Left Lap (adjuster only on right side)	53653711	52122116

2-INCH x 2-INCH LATCH & LINK RESTRAINTS

Manufacturer's Certified to SFI 16.5.

2-inch Lap x 2-inch Indiv. Shoulders; Latch & Link - SFI 16.5 <small>*includes Bolt-In Ends and Three-Bar for Wrap</small>	5 Point	6 Point
Pull-Down Right Lap; Fixed Left Lap (adjuster only on right side)	(B) 51122226	51122226
Pull-Up Right Lap; Fixed Left Lap (adjuster only on right side)	52122226	52122226

3-INCH x 3 into 2-INCH TRANSITION LATCH & LINK RESTRAINTS

Manufacturer's Certified to SFI 16.5.

3-inch Lap x 3-inch to 2-inch Transition Indiv. Shoulders - SFI 16.5 <small>*includes Bolt-In Ends and Three-Bar for Wrap</small>	5 Point	6 Point
Pull-Down Right Lap; Fixed Left Lap (adjuster only on right side)	51122326	(C) 51122326
Pull-Up Right Lap; Fixed Left Lap (adjuster only on right side)	52122326	52122326

****2-INCH WEBBING**

Dr. John Melvin, the late renowned biomedical scientist and longtime safety consultant to NASCAR, researched the topic of two-inch versus three-inch restraints and arrived at an interesting finding. "Two-inch belts work much better on most bodies. Two-inch restraints are just as good as three-inch if tested to the SFI 16.5 specification," remarked Dr. Melvin at one of the many motorsports safety seminars he participated in.

Because three-inch webbing has the tendency to "ride-up" or fold over the pelvic/hip bone, there is actually less webbing coverage of this area with a standard three-inch lap belt. The Iliac Crest is the curved ridge at the top of the pelvic bone and it forms the most prominent and largest bone in your pelvis. This area of the body is generally most capable of withstanding force, which is why it is important for the lap belts to fit as tightly and comfortably into the Iliac Crest as possible. Two-inch webbing, tested to the 16.5 SFI specification, seats better and more comfortably into the pelvic region, allowing for improved webbing coverage and reducing the incidence of submarining.

Too many accomplishments to list, Dr. John Melvin was a brilliant and humble man whose research and work in motorsports safety truly revolutionized the industry. Dr. Melvin is missed by so many personally and professionally, may he race in peace.

Manufacturer's Certified to the SFI 16.1 Specification

SFI COMPLIANT
SPEC 16.1

3-INCH x 3-INCH CAMLOCK RESTRAINTS

Manufacturer's Certified to SFI 16.1.

3-inch Lap x 3-inch Indiv. Shoulders; Camlock - SFI 16.1 *includes Bolt-In Ends and Three-Bar for Wrap	5 Point	6 Point
Pull-Down Both Laps (adjuster on right and left side)	57341111	57351111
Pull-Up Both Laps (adjuster on right and left side)	58341111	(A) 58351111

3-INCH x 3into2-INCH TRANSITION CAMLOCK RESTRAINTS

Manufacturer's Certified to SFI 16.1.

3-inch Lap x 3-inch to 2-inch Transition Indiv. Shoulders - SFI 16.1 *includes Bolt-In Ends and Three-Bar for Wrap	5 Point	6 Point
Pull-Down Both Laps (adjuster on right and left side)	57341231	57351231
Pull-Up Both Laps (adjuster on right and left side)	(B) 58341231	58351231

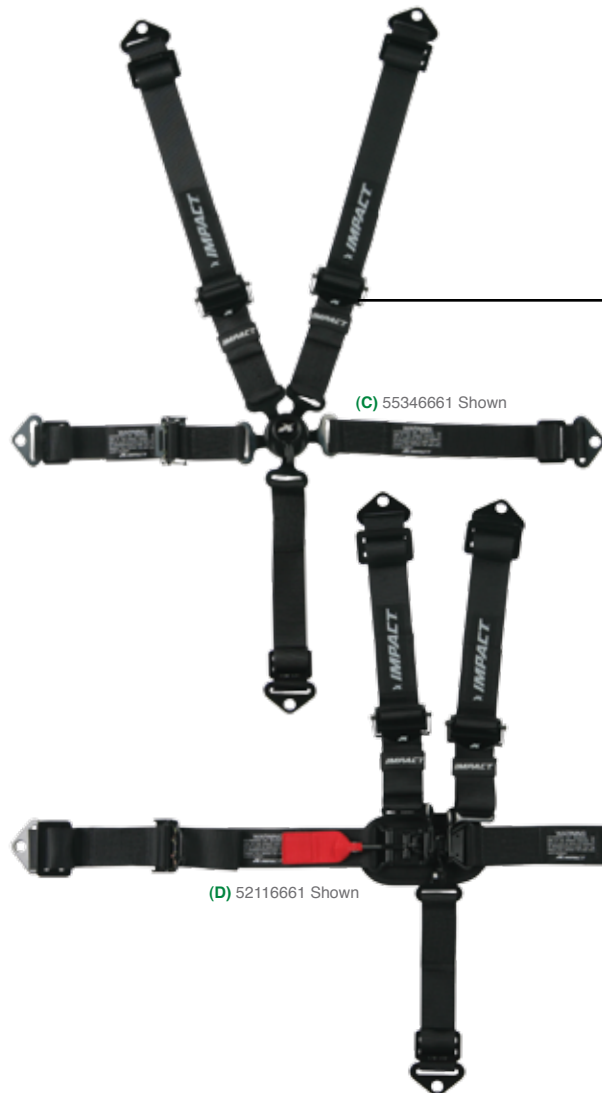

(C) 55346661 Shown

(D) 52116661 Shown



(A) 58351111 Shown

(B) 58341231 Shown

QUARTER MIDGET & JUNIOR DRAG SERIES RESTRAINTS

Manufacturer's Certified to the SFI 16.2 Specification

SFI COMPLIANT
SPEC 16.2

JUNIOR CAMLOCK RESTRAINTS

Manufacturer's Certified to SFI 16.2.

Lap x Individual Shoulders; CAM - SFI 16.2 *includes Bolt-In Ends and Three-Bar for Wrap	5 Point
Pull-Down Right Lap; Fixed Left Lap (adjuster only on right side)	(C) 55346661
Pull-Up Right Lap; Fixed Left Lap (adjuster only on right side)	56346661
Pull-Down Both Laps (adjuster on right and left side)	57346661
Pull-Up Both Laps (adjuster on right and left side)	58346661

JUNIOR LATCH & LINK RESTRAINTS

Manufacturer's Certified to SFI 16.2.

Lap x Individual Shoulders; L&L - SFI 16.2 *includes Bolt-In Ends and Three-Bar for Wrap	5 Point
Pull-Down Right Lap; Fixed Left Lap (adjuster only on right side)	51116661
Pull-Up Right Lap; Fixed Left Lap (adjuster only on right side)	(D) 52116661
Pull-Down Both Laps (adjuster on right and left side)	53116661
Pull-Up Both Laps (adjuster on right and left side)	54116661

Manufacturer's Certified to the SFI 16.1 Specification

SFI COMPLIANT
SPEC 16.1

3-INCH x 3-INCH LATCH & LINK RESTRAINTS

Manufacturer's Certified to SFI 16.1.

3-inch Lap x 3-inch Indiv. Shoulders; Latch & Link - SFI 16.1 *includes Bolt-In Ends and Three-Bar for Wrap	5 Point	6 Point
Pull-Down Right Lap; Fixed Left Lap (adjuster only on right side)	(A) 51111111	51121111
Pull-Up Right Lap; Fixed Left Lap (adjuster only on right side)	52111111	52121111
Pull-Down Both Laps (adjuster on right and left side)	53111111	53121111
Pull-Up Both Laps (adjuster on right and left side)	54111111	54121111

3-INCH x 3-INCH INTEGRATED LATCH & LINK RESTRAINTS

Manufacturer's Certified to SFI 16.1.

3-inch Integrated Lap x 3-inch Indiv. Shoulders; L&L - SFI 16.1 *includes Bolt-In Ends and Three-Bar for Wrap	5 Point	6 Point
Pull-Down Both Laps (adjuster on right and left side)	(B) 59111111	59121111
3-inch Integrated Lap x 3-inch V-Style Shoulders; L&L - SFI 16.1 *includes Bolt-In Ends and Three-Bar for Wrap	5 Point	6 Point
Pull-Down Both Laps (adjuster on right and left side)	59811111	59821111

3-INCH x 3 into 2-INCH TRANSITION LATCH & LINK RESTRAINTS

Manufacturer's Certified to SFI 16.1.

3-inch Lap x 3-inch to 2-inch Transition Indiv. Shoulders; L&L - SFI 16.1 *includes Bolt-In Ends and Three-Bar for Wrap	5 Point	6 Point
Pull-Down Right Lap; Fixed Left Lap (adjuster only on right side)	51111231	51121231
Pull-Up Right Lap; Fixed Left Lap (adjuster only on right side)	52111231	52121231
Pull-Down Both Laps (adjuster on right and left side)	(C) 53111231	53121231
Pull-Up Both Laps (adjuster on right and left side)	54111231	54121231

3-INCH x 3-INCH V-SHOULDER LATCH & LINK RESTRAINTS

Manufacturer's Certified to SFI 16.1.

3-inch Lap x 3-inch V-Shoulders; L&L - SFI 16.1 *includes Bolt-In Ends and Three-Bar for Wrap	5 Point	6 Point
Pull-Down Right Lap; Fixed Left Lap (adjuster only on right side)	(D) 51811111	51821111
Pull-Up Right Lap; Fixed Left Lap (adjuster only on right side)	52811111	52821111
Pull-Down Both Laps (adjuster on right and left side)	53811111	53821111
Pull-Up Both Laps (adjuster on right and left side)	54811111	54821111



(A) 51111111 Shown

(B) 59111111 Shown

(C) 53111231 Shown

(D) 51811111 Shown

HARNESS PADS

Impact's 3-inch harness pads are manufactured from a Nomex covered foam and are easily added or removed with the hook-and-loop closure. 50000001



ARM RESTRAINTS

Impact arm restraints feature webbed leashes, padded arm bands and dual adjustment for a customized driver fit for both the arm circumference and leash length. Manufacturer's certified to the SFI 3.3 Spec. 75000910

SFI COMPLIANT
SPEC 3.3

CUSTOM WINDOW NET ORDER FORM

IMPACT	TEAM / DRIVER NAME:	CUP SERIES:	LABEL:
	DATE:	SALES REP:	SPECS BY:
			AUTHORIZATION SIGNATURE:

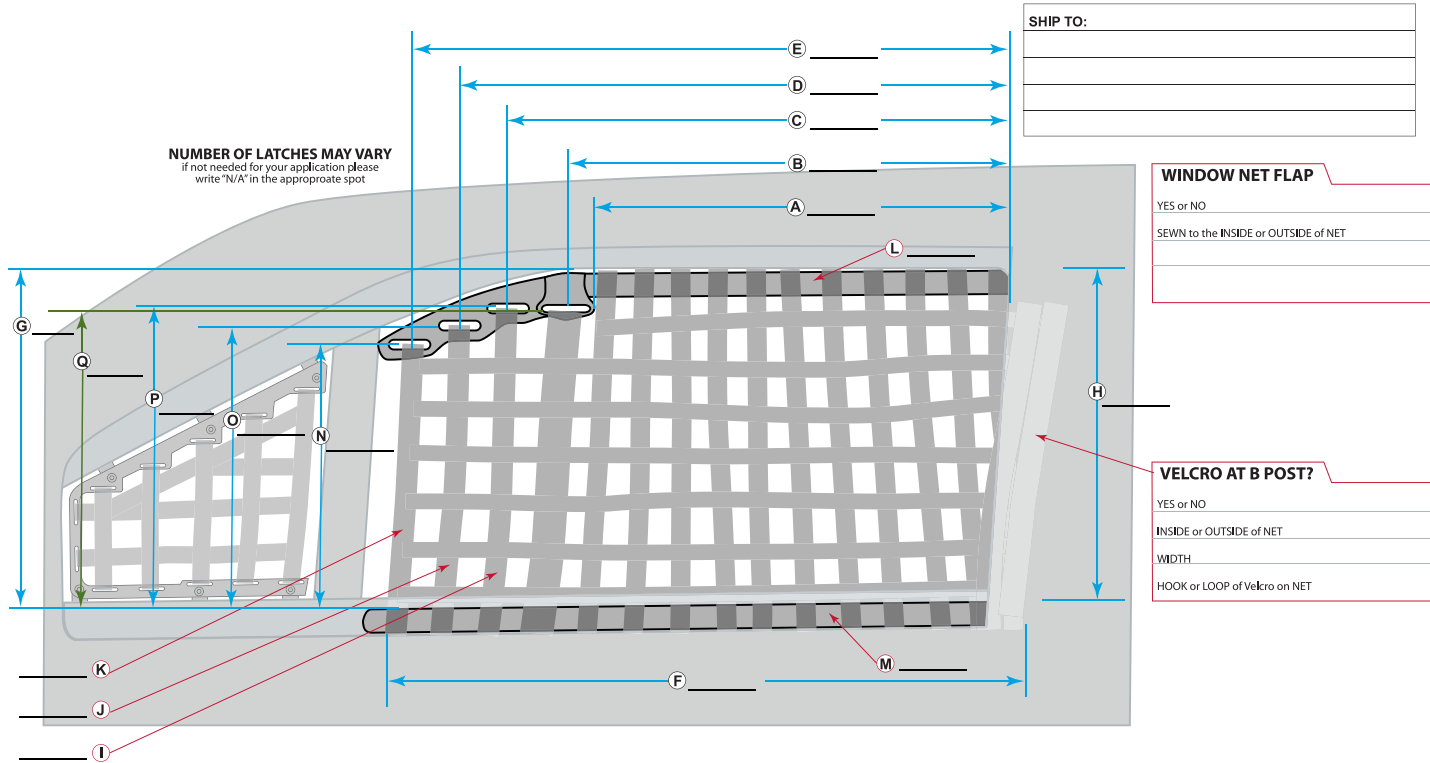

- NOTES:**
- A** LENGTH OF NET TOP
END TO END LENGTH OF TOP PORTION OF LOOPED NET
 - B** TOP LENGTH TO MAIN LATCH
FRONT OF BAR SADDLE TO CENTER OF MAIN LATCH
 - C** TOP LENGTH TO SECOND LATCH
FRONT OF BAR SADDLE TO CENTER OF SECONDARY LATCH
 - D** TOP LENGTH TO THIRD LATCH
FRONT OF BAR SADDLE TO CENTER OF THIRD LATCH
 - E** TOP LENGTH TO FOURTH LATCH
FRONT OF BAR SADDLE TO CENTER OF FOURTH LATCH
 - F** LENGTH OF NET BOTTOM
END TO END LENGTH OF BOTTOM PORTION OF LOOPED NET
 - G** FRONT HEIGHT
TOP EDGE OF TOP BAR TO TOP EDGE OF BOTTOM BAR
 - H** REAR HEIGHT
TOP EDGE OF TOP BAR TO TOP EDGE OF BOTTOM BAR
 - I** WEBBING WIDTH SECONDARY
WEBBING SIZE FOR SECOND LATCH
 - J** WEBBING WIDTH THIRD
WEBBING SIZE FOR THIRD LATCH
 - K** WEBBING WIDTH FOURTH
WEBBING SIZE FOR FOURTH LATCH
 - L** DIAMETER OF TOP BAR
 - M** DIAMETER OF BOTTOM BAR
 - N** HEIGHT OF FOURTH LATCH
TOP EDGE OF BOTTOM BAR TO CENTER OF FOURTH LATCH
 - O** HEIGHT OF THIRD LATCH
TOP EDGE OF BOTTOM BAR TO CENTER OF THIRD LATCH
 - P** HEIGHT OF SECOND LATCH
TOP EDGE OF BOTTOM BAR TO CENTER OF SECOND LATCH
 - Q** HEIGHT OF MAIN LATCH
TOP EDGE OF BOTTOM BAR TO CENTER OF MAIN LATCH

1531 E. NORTHFIELD DR. SUITE 400 • BROWNSBURG, IN • 46112 (p) 317.852.3067 (f) 317.852.8945 ximpactusa.com
Cup Series Window Net Worksheet Rev.2013b (5/20/13) PROPERTY OF MASTERCRAFT SAFETY U.S.A. COPYRIGHT 2013 ALL RIGHTS RESERVED

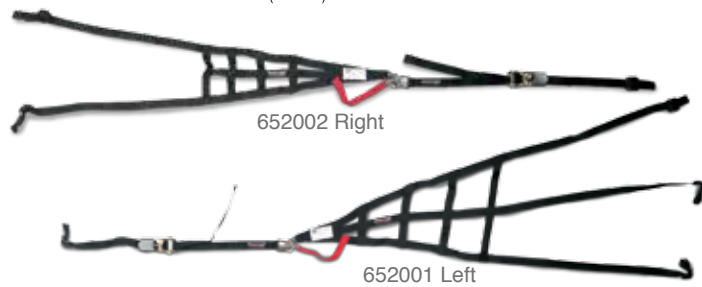

MASTERCRAFT DRIVER'S NET

The MCS Driver's net is designed for use in off-road chassis' and is a mandated safety item in several classes in the Lucas Oil Off Road Racing Series. The MCS driver's net is constructed from three individual straps of 1-inch webbing for maximum coverage and improved lateral support. Available as a left and right side installation, each driver's net is adjustable for the ideal fit to your chassis. Features three bar for chassis tube attachment, ratchet strap for adjustability, and quick release connector closure. Manufacturer's certified to the SFI 37.1 Spec.

SFI COMPLIANT
SPEC 37.1

Type		
Driver's Net (designated by SFI tag placement) - Left 24"x13" Net size; adjustable range 36" to 85"	652001	
Driver's Net (designated by SFI tag placement) - Right 22" x 8" Net size; adjustable range 24" to 75"	652002	

SPRINT CAR CAGE NETS

Impact's triangle cage net is designed for use in Sprint and Midget Car cages and constructed from 1-inch webbing. Includes a three-bar adjuster for chassis tube attachment and latch and link closure. Manufacturer's certified to the SFI 37.1 Spec.
76000610

SFI COMPLIANT
SPEC 37.1



DRAG LINK STRAP

For use in open-wheel racing as an added safety feature to keep the car's drag link tethered to the frame during a crash.

50000071

CUSTOM WINDOW NETS

Manufacturer's certified to the SFI 27.1 Specification. Available in our standard 1-inch ribbon style or in our exclusive mesh with 1-inch polyester binding, Impact can custom hand-craft window nets from a supplied pattern and to your exacting standards. Simply send us your pattern cut from cardboard or heavy paper (we can also accept most CAD files as well) and note the top, bottom, front and rear of the chassis in addition to the method of attachment.

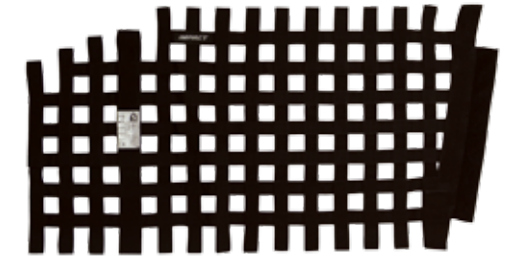

- Methods of Custom Window Net Attachment
- A) Snaps
 - B) Screws
 - C) Velcro
 - D) Grommets
 - E) Bar flaps

The Crashes
people remember,
but drivers remember
the near misses.

- Mario Andretti

MASTERCRAFT TIE-DOWNS

MasterCraft Safety Tie-Downs are manufactured from the highest grade steel hardware and feature multiple rows of reinforced stitching for durability, higher load ratings and quality. Available in varying lengths and widths with both S-Hook and Snap Hook attachment ends and with Cam Buckle or Ratchet hardware adjusters, MCS has a tie-down to suit your needs.

1-inch straps are ideal for motorcycles, ATVs, watercraft and light equipment
2-inch straps are ideal for tying down race cars and other heavy load equipment

NOT FOR USE AS A TOW STRAP

1" x 6' (or 15') STRAP w/Vinyl Coated S-Hooks

1" x 6' nylon strap with cam buckles and large vinyl coated S-hooks. Rated at 1200 pounds maximum load. Available in Red only.

RED - 6' LENGTH	400001
RED - 15' LENGTH	400003



1" x 6' RATCHET STRAP

1" x 6' nylon strap with wide handle ratchet (for folks with big hands) with either large vinyl coated S-hooks OR Snap Hooks. Rated at 2800 pounds maximum load. Available in Red only.

RED w/ VINYL COATED S-HOOKS	400004
RED w/ SNAP HOOKS	400006



1" x 15' RATCHET STRAP

1" x 15' nylon strap with wide handle ratchet (for folks with big hands) with either large vinyl coated S-hooks OR Snap Hooks. Rated at 2800 pounds maximum load. Available in Red only.

RED w/ VINYL COATED S-HOOKS	400007
RED w/ SNAP HOOKS	400008



2" x 7' RATCHET STRAP w/Chain Extension or Twisted Snap Hooks

2" x 7' heavy-duty strap features wide handle ratchet and Anchor hooks on chains OR large twisted snap hooks. Rated at 10,000 pounds maximum load. Available in Red or Yellow.

RED w/ CHAIN EXTENSION	400011
YELLOW w/ CHAIN EXTENSION	400012
RED w/ TWISTED SNAP HOOKS	400013
YELLOW w/ TWISTED SNAP HOOKS	400014



2" x 8' RATCHET STRAP w/Twisted Snap Hooks & Axle Loop

2" x 8' heavy-duty strap features wide handle ratchet, Snap hook at one end and Axle loop with protective sleeve at the other. 12" of adjustment. Rated at 10,000 pounds maximum load.

RED	400015
YELLOW	400016



NYLON NITRO CHUTE

Impact's crossform Nylon Nitro chute is designed with the 200+mph cars in mind. Made to deploy quickly and evenly for a controlled deceleration, our nylon drag chutes are offered in two sizes; 10-foot 4-Line and 12-foot 8-Line configurations, dependent upon the weight and speed of your car. The science of drag chute design considers flight stability, deployment force, flow-through, attachment points and ease of packing. Impact considers all of these factors when manufacturing our chutes, providing you with a reliable and durable product you can be confident in using. Includes: Outer Bag, Lanyard, and Pilot Chute. Colors: Black/Red/Blue

TYPE/SIZE	
10-FOOT, 4-LINE CHUTE, BLUE	77010006
10-FOOT, 4-LINE CHUTE, RED	77010007
10-FOOT, 4-LINE CHUTE, BLACK	77010010
12-FOOT, 8-LINE CHUTE, BLUE	77013006
12-FOOT, 8-LINE CHUTE, RED	77013007
12-FOOT, 8-LINE CHUTE, BLACK	77013010

PRO STOCK CHUTE

Our Nylon Pro-Stock drag chute features a lightweight crossform, 4-point design and is typically used in the 150-200mph cars. Hand-crafted in the heart of Indy's Gasoline Alley, Impact's Pro-Stock drag chute offers reliable performance and stopping power and includes: Outer bag (features a hole for an Air Launcher), Inner bag (for use with Pilot Chute), Lanyard, and Pilot Chute; Can be used with either an Air Launcher or Pilot Chute. Colors: Black/Red/Blue

COLOR	
8-FOOT, PRO STOCK CHUTE, BLUE	77008006
8-FOOT, PRO STOCK CHUTE, RED	77008007
8-FOOT, PRO STOCK CHUTE, BLACK	77008010

PRO STOCK AIR LAUNCHER

Impact's exclusive Pro-Stock Air Launcher is designed with a flat launch plate to allow unhindered deployment of chute lines. 77300908

PILOT CHUTE

The life of a spring is directly related to the design and materials used and that is why Impact has chosen Hypercoil as our exclusive supplier of our Pilot Chute springs. Manufactured from the highest quality, high-tensile steel available, the Hypercoil spring has a proven racing heritage and each coil is designed to be as light as possible while at the same time able to endure the stresses of extreme conditions providing you with reliable deployment performance all season long.

TYPE	
STANDARD PILOT CHUTE	77100908



DRAG CHUTE ACCESSORIES

TYPE	
6-INCH CHUTE BAG, SILVER (FOR ALL 10 & 12-FOOT NYLON CHUTES)	77200108
6-INCH CHUTE BAG, BLACK (FOR ALL 10 & 12-FOOT NYLON CHUTES)	77200110
7-INCH CHUTE BAG, SILVER	77200908
7-INCH CHUTE BAG, BLACK	77200910
PRO STOCK OUTER BAG (HAS HOLE FOR AIR LAUNCHER)	77200210
PRO STOCK INNER BAG (FOR USE WITH AIR LAUNCHER)	77200310
PILOT LANYARD	77400000
CHUTE PACKING STRING, 16-INCH	77200311

KEVLAR NITRO CHUTE

Impact's Kevlar Drag Chute features an 8-line crossform design and was specifically developed for use on 200mph+ cars. Our 12-foot all Kevlar panel construction offers a 20-percent lighter product and improved abrasion and fire resistance over a comparable nylon chute. Impact's Kevlar Drag Chute also features longer shroud lines for a low and straight deployment with a softer deceleration at launch. Includes: Outer Black Nomex Pack, Lanyard, and our Compression Spring Launch Pilot Chute. Colors: "Kevlar® Yellow" Only 77500000



Black Nomex® Pack

Silver Pack



Air Launcher



Pilot Chute

Auto racing, bull fighting, and mountain climbing are the only real sports... all others are games.

- Ernest Hemingway



DDN SCHUMACHER'S TONY SCHUMACHER, SEVEN TIME NHRA TOP FUEL CHAMPION MAKING A RUN IN THE U.S. ARMY CAR. (Photo provided by Dan Schumacher Racing).



"FAST JACK" BECKMAN, TWO TIME NHRA CHAMPION, TAKING DSR'S INFINITE HERO FUNNY CAR DOWN THE TRACK. (Photo provided by Dan Schumacher Racing).

CLAMSHELL HELMET BAG

The super-soft interior padding featured on our exclusive MCS Clam Shell bag protects your valuable helmet from scratches and dings when not in use. Manufactured from a durable, water resistant Cordura® outer shell with full zipper closure and molded rubber handle, the MCS Clam Shell bag makes protecting and transporting your helmet quick and easy.
Colors: Black
640148



DRAWSTRING HELMET SOCK

Made from a high-performance and abrasion resistant fabric, the Impact drawstring sock offers an affordable option for protecting your helmet from everyday scratches and scrapes. Designed with heavy-duty drawstring closures, the sock offers an easy way to stow and transport your helmet while keeping it safe from mishaps.
Colors: Black
71100910



DIRTGEAR BAG SINGLE HELMET

The Canvas Dirt Gear Bag features a helmet storage pocket and 5 outer pouches that vary in size. The bag also features durable handles and a detachable shoulder strap. 13"H x 32"W x 13"D.
Colors: Black
640150



PADDED HELMET BAG

Your helmet protects you. Make sure it's protected when not in use! A double-lined tear resistant nylon outer-shell and soft faux shearing liner keeps your gear safe while two easy-to-carry handles make transporting your helmet to and from the track a breeze. The Impact helmet bag offers a full-length zipper and extra space for easy helmet stowage and integrated pockets provide storage for miscellaneous accessories.
Colors: Black
71000915



SUIT TOTE

The Impact Suit Tote is an essential item for keeping your suit clean and protected when not in use. Manufactured from a heavy-duty, reinforced nylon and featuring a webbed handle, the Impact Suit Tote also offers a large main compartment for quick and easy storage of your suit along with a separate side compartment for storage of gloves or other racing necessities.
Colors: Black Only
72100010



GEAR BAG

The Impact Gear Bag is constructed from a heavy-duty reinforced nylon with webbed handle and removable padded shoulder strap that features three separate compartments to hold your helmet, suit, frontal head restraint, gloves, shoes and accessories. The main compartment has a heavy-duty zipper and reinforced base to maintain the shape of the bag during loading and carrying while the two 3/4-zip side pockets provide additional storage for miscellaneous items. This durable bag can handle everyday wear and tear and easily doubles as travel luggage offering excellent storage capacity for weekend trips or transporting all your gear to the race track.
Size: 12" x 12" x 11"
Colors: Black Only
72000010



CANVAS TOOL BAG

The MCS Canvas Tool Bag is made from a heavy-duty cotton-duck canvas material and is equipped with two convenient carrying handles and a bag strap for mounting to a door bar or chassis of an off-road truck if desired. Great for storing tools, jumper cables, tow-ropes, and wrench roll-ups, this durable tool bag features a reinforced construction ensuring years of use.
Size: 17-inch x 8-inch x 6-inch with 1 Bag Strap for Mounting
Colors: Black Only
640142



IMPACT GUN HOLSTER

Choose from two sizes to accommodate a 12 volt to 36 volt Impact Gun. Super-rugged vinylized material keeps impact gun from moving about, and buckle closure secures gun. Other pockets hold lug nuts, socket and spare battery. Attaches with hook and loop panel and straps.
Colors: Black Only
Small - Typically carries guns up to 18 volts
(Small L-Shape bag measures 16" x 12")
Large - Typically carries guns up to 36 volts
(Large L-Shape bag measures 20" x 16")

TYPE/SIZE	
SMALL, 18 VOLT IMPACT GUN HOLSTER	640130
SMALL, 24-48 VOLT IMPACT GUN HOLSTER	640131



MECHANIC'S APRON

Featuring two upper pockets for stashing, pens, notes, tools and other necessities, the MCS Mechanic's Apron is manufactured from reinforced cotton-duck canvas for durability and longevity, even in the greasiest environments.
Colors: Black Only
640143



WALKER BAG

This handy bag was created especially for Walker Evans. Our 10" x 20" bag with zipper closure is made of tough, waterproof and tear-resistant material, padded for durability with two carry handles.
Colors: Black / Red

COLOR	BLACK	RED
	640128	640126



TOOL TOTES

Available in three standard sizes, these water repellant totes feature interior padding on the bottom to protect your tools. The diagonal zipper allows the bag to open wide, providing easy access inside - even with gloves on. To hold the bag in place, we have included bag straps that screw or pop-rivet to the floor and wrap around the bag with buckle closure for keeping your tools safely and securely stowed during transport or during the most spirited off-road adventures.
Colors: Black / Red
Small - 12" x 6" x 2.5" with One Bag Strap
Regular - 17" x 6" x 2.5" with One Bag Strap
Large - 17" x 8" x 3.5" with Two Bag Straps

TYPE/SIZE	
TOOL TOTE - SMALL, RED	640101
TOOL TOTE - SMALL, BLACK	640103
TOOL TOTE - REGULAR, RED	640105
TOOL TOTE - REGULAR, BLACK	640107
TOOL TOTE - LARGE, RED	640109
TOOL TOTE - LARGE, BLACK	640111



Small Pocket Roll-Up



4-Pocket Roll-Up

WRENCH ROLL-UPS

Constructed from rugged 100% cotton-duck canvas, these organizers fit open end/box wrenches and close with a hook and loop strap.
Colors: Black / Red

TYPE/SIZE	
SMALL POCKET ROLL-UP, 27w X 26h, 16 SLOTS, RED	640174
SMALL POCKET ROLL-UP, 27w X 26h, 16 SLOTS, BLACK	640139
2 POCKET ROLL-UP, 28.75w X 19h, 8 SLOTS, RED	640176
2 POCKET ROLL-UP, 28.75w X 19h, 8 SLOTS, BLACK	640140
4 POCKET ROLL-UP, 28.75w X 19h, 4 SLOTS, RED	640178
4 POCKET ROLL-UP, 28.75w X 19h, 4 SLOTS, BLACK	640141