

# **MATRIX S**

## **Specialist's Guide**

# MATRIX S

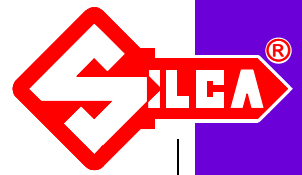

FOR:

## ABLOY (S)

OPTIONAL

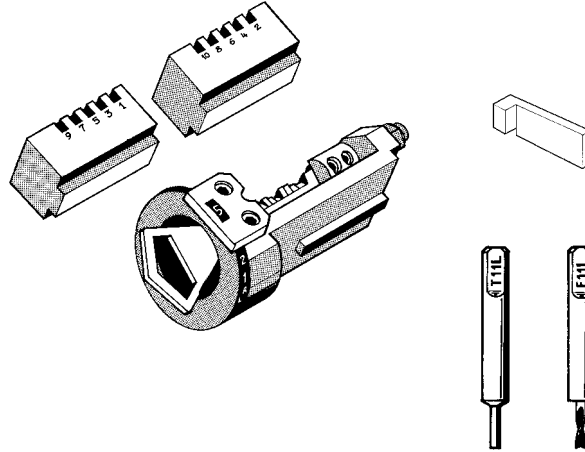
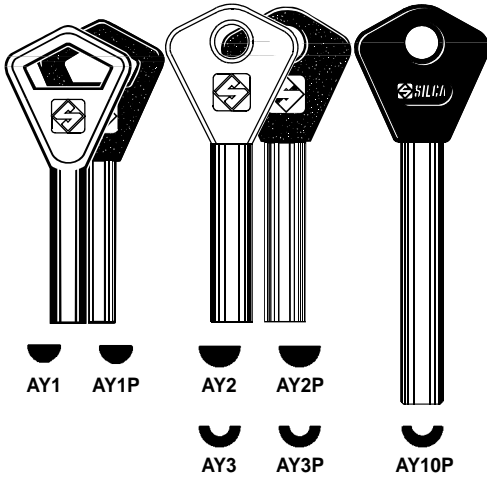

**D707910ZB**

Code attachment for ABLOY keys OY

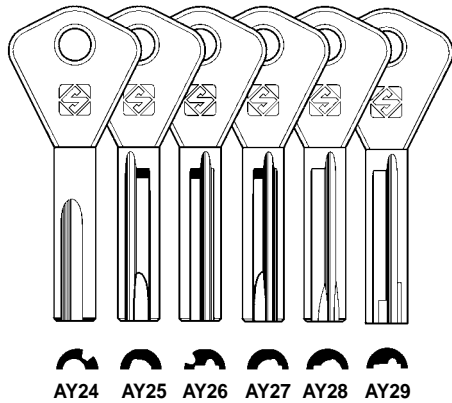
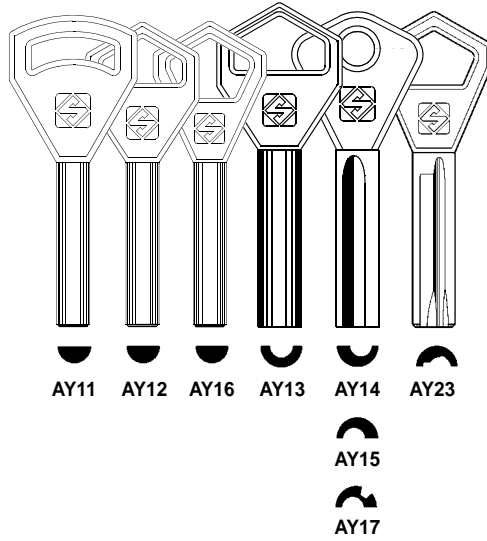

FOR:

## ABUS (D)

STANDARD

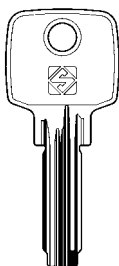

**AB62**

**D901070ZR**

Tracer point T1

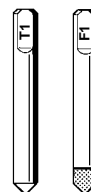

**D701071ZB**

Cutter F1



# MATRIX S

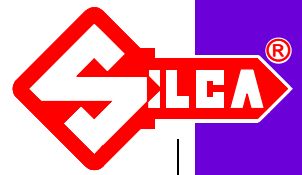

FOR:

**AGB (I)**

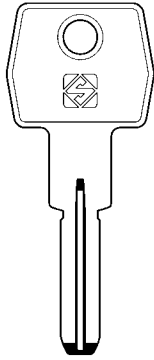

**AGB5**

OPTIONAL



**D906658ZR**  
Tracer point T39

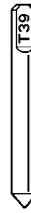

**D706659ZB**  
Cutter F39



FOR:

**AGB (I)**

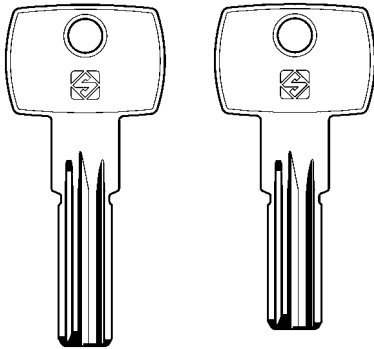

**AGB6**

**AGB7**

**AGB8**

**AGB9**

Scudo 5000

OPTIONAL



**D906658ZR**  
Tracer point T39



**D706659ZB**  
Cutter F39



FOR:

**AZBE (E)**

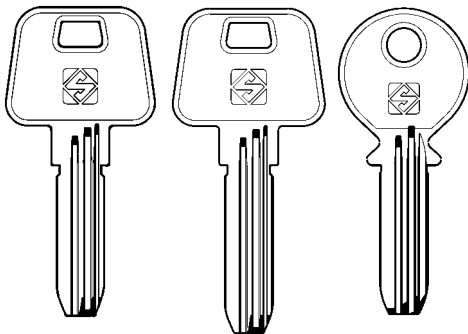

**AZ6**

**AZ7**

**AZ8**

CAVERS (F)

OPTIONAL



**D908799ZR**  
Tracer point T42

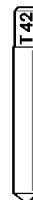

**D708800ZB**  
Cutter F42



FOR:

**BKS (D)**

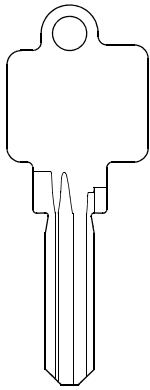

(WS50 MK)

OPTIONAL



**D738358ZB**  
Adapters A29

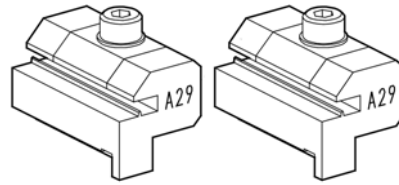

**D738384ZB**  
Tracer point T68

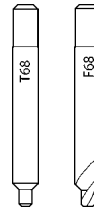

**D738383ZB**  
Cutter F68

FOR:

**BRICARD (F)**

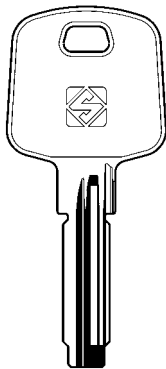

**JIT**  
BD16

OPTIONAL



**D722724ZB**  
Adaptors

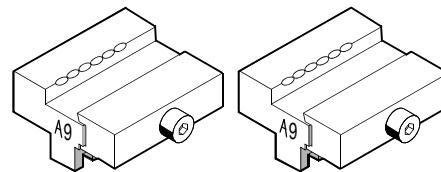

STANDARD



**D901070ZR**  
Tracer point T1

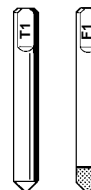

**D701071ZB**  
Cutter F1

# MATRIX S

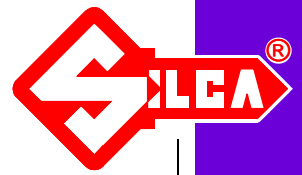

FOR:

**CISA (I)**

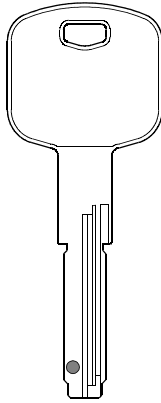

AP3 System

System protected by a password issued by Silca on receipt of authorization.

OPTIONAL



**D722724ZB**  
Adaptors

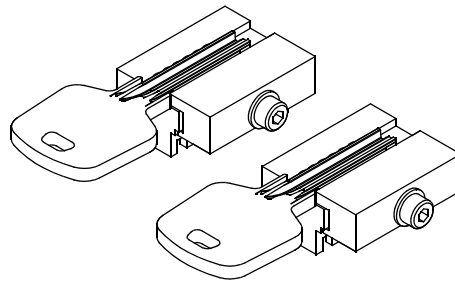

STANDARD



**D901070ZR**  
Tracer point T1

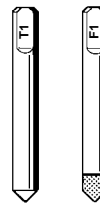



**D701071ZB**  
Cutter F1

FOR:

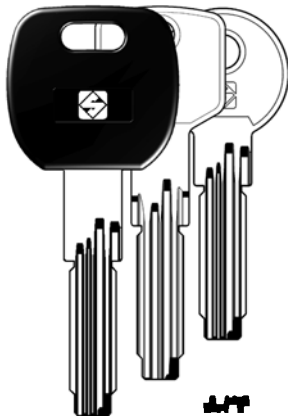
**CISA (I)**



  
CS70

   
CS70P CS62  
ASTRAL  
system 357

  
AB48

ABUS

OPTIONAL



**D722724ZB**  
Adaptors

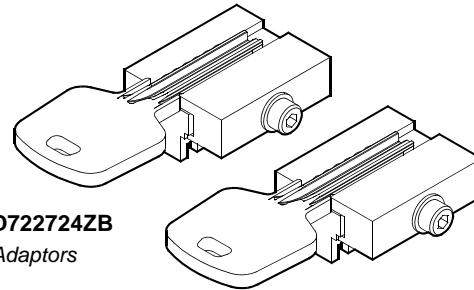

**D901070ZR**  
Tracer point T1



**D701071ZB**  
Cutter F1



FOR:

## CODEM (F)

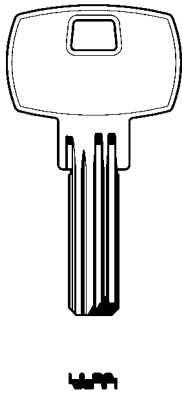

OPTIONAL



**D901078ZR**  
*Tracer point T5*

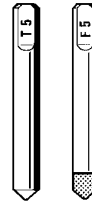

**D701079ZB**  
*Cutter T5*

FOR:

## CORNI (I)

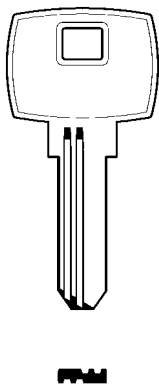

OPTIONAL



**D908799ZR**  
*Tracer point T42*

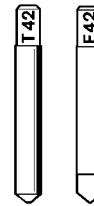

**D708800ZB**  
*Cutter F42*

FOR:

## DOMUS (GR)

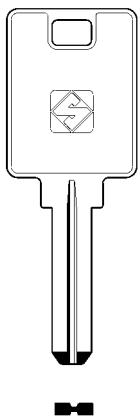

OPTIONAL



**D901155ZR**  
*Tracer point T20*



**D701156ZB**  
*Cutter F20*

FOR:

## DOM (D) CORBIN (I)

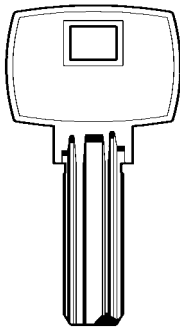

IX6 KG Profile 121

OPTIONAL



**D716915ZB**  
Adaptors

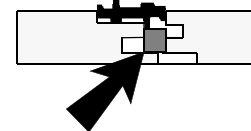
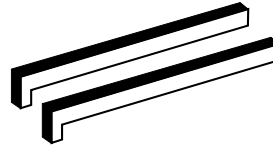

FOR:

## DOM (D)

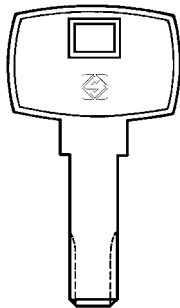

DM22



DM22TV1



DM22TV5



DM22TV9



DM22TV2



DM22TV6



DM22TV10



DM22TV3



DM22TV7



DM22TVP



DM22TV4



DM22TV8

IX10

STANDARD



**D901070ZR**  
Tracer point T1



**D701071ZB**  
Cutter F1

OPTIONAL



**D901076ZR**  
Tracer point T4

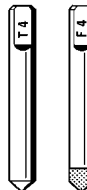

**D701077ZB**  
Cutter F4



OPTIONAL



**D705664ZB**  
Adaptors + tools

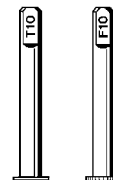



# MATRIX S

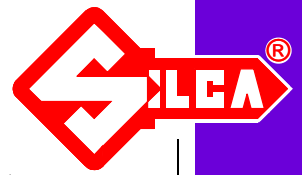

FOR:

## DOM (D) CORBIN (I)

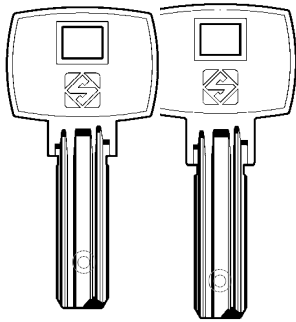

(Various)

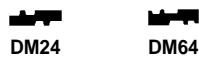
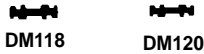

Prof. 48-49



IX5 - IX10

OPTIONAL



**D710026ZB**  
Adaptors for DOM keys



OPTIONAL



**D902098ZR**  
Tracer point T13

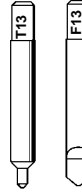

**D702099ZB**  
Cutter F13



**D711434ZB**  
Tracer point T52



**D711433ZB**  
Cutter F52



OPTIONAL



**D901076ZR**  
Tracer point T4



**D701077ZB**  
Cutter F4

FOR:

## DOM (D)

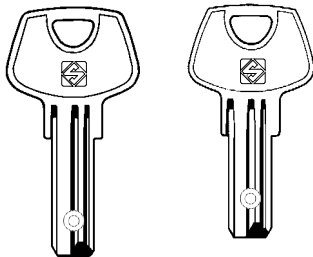
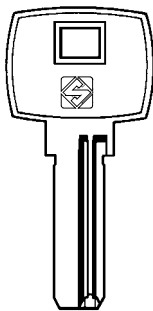

IX IND.

OPTIONAL



**D902098ZR**  
Tracer point T13



**D702099ZB**  
Cutter F13



**D711434ZB**  
Tracer point T52

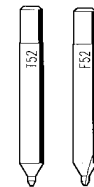

**D711433ZB**  
Cutter F52



**D901076ZR**  
Tastatore T4



**D701077ZB**  
Fresa F4





# MATRIX S

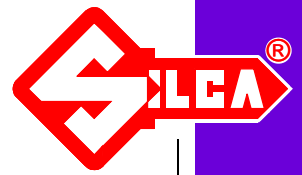

FOR:

**DOM (D)  
CORBIN (I)**

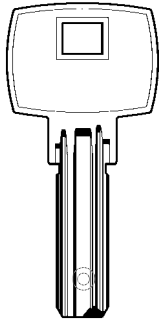

IX5 KG - IX5 HR

OPTIONAL



**D711421ZB**  
Adaptors for DOM HOCHRIPPE keys

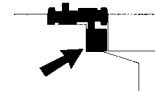

**D904753ZR**  
Tracer point T15



**D704754ZB**  
Cutter F15



**D711434ZB**  
Tracer point T52

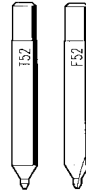

**D711433ZB**  
Cutter F52



OPTIONAL



**D901076ZR**  
Tracer point T4



**D701077ZB**  
Cutter F4

FOR:

**ELZETT (H)**

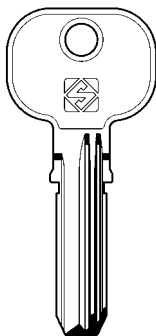

**EL9**

OPTIONAL



**D901078ZR**  
Tracer point T5



**D701079ZB**  
Cutter F5



# MATRIX S

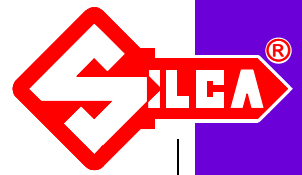

FOR:

## EZCURRA (E)

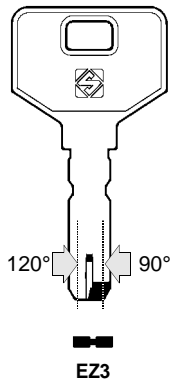

OPTIONAL



**D709823ZB**  
EZCURRA keys tool set

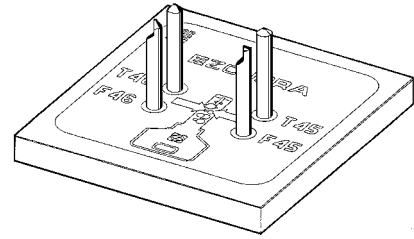

**D909805ZR**  
Tracer point T45



**D709806ZB**  
Cutter F45



**D909807ZR**  
Tracer point T46

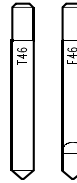

**D709808ZB**  
Cutter F46



FOR:

## FIAM (I)

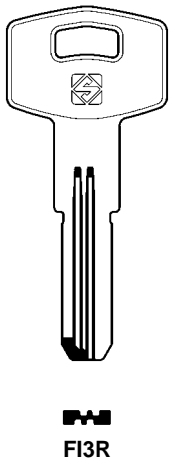

OPTIONAL



**D734313ZB**  
Adapters A20 for FIAM keys

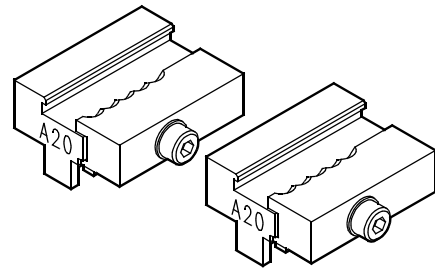

OPTIONAL



**D711418ZB**  
Tracer point T55

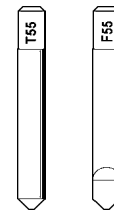

**D711419ZB**  
Cutter F55

FOR:

## FTH (F)

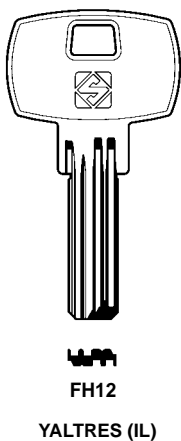

OPTIONAL



**D901078ZR**  
Tracer point T5

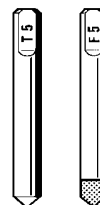

**D701079ZB**  
Cutter F5



FOR:

**HUWIL (D)**

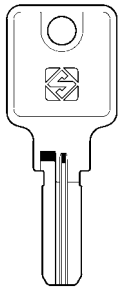

**HW15R**

OPTIONAL

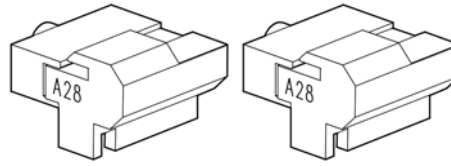

**D736860ZB**

*Adapters A28 for HUWIL HW15R keys*

STANDARD



**D905487ZR**

*Tracer point T22*



**D705488ZB**

*Cutter F22*



FOR:

**IFAM (E)**

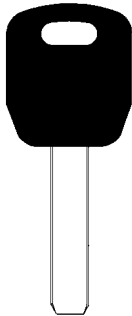

**HW15R**

OPTIONAL

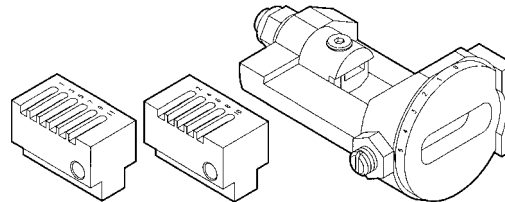

**D711185ZB**

*Code attachment for IFAM keys*

**D909147ZR**

*Tracer point T44*



**D709148ZB**

*Cutter F44*



FOR: **ISEO (I)**

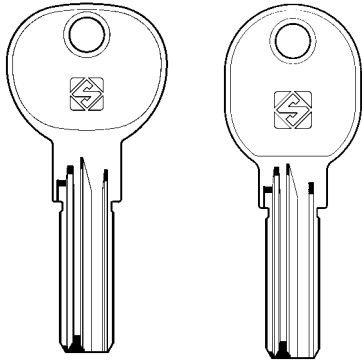

**IE14**  
R11

**IE15**  
R6

OPTIONAL



**D906658ZR**  
Tracer point T39

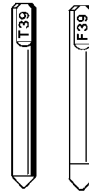

**D706659ZB**  
Cutter F39

FOR: **JIS (E)**

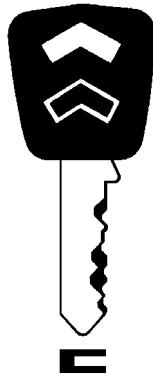

OPTIONAL

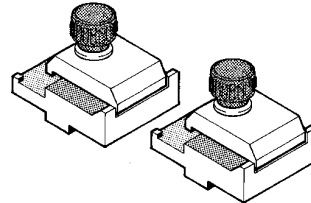

**D701664ZB**  
Adaptors for JIS keys

STANDARD



**D905487ZR**  
Tracer point T22



**D705488ZB**  
Cutter F22

FOR: **KABA (CH)**

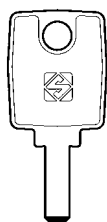

**KA8**

OPTIONAL

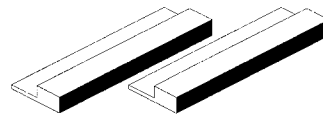

**D710008ZB**  
Adaptors for KABA-Micro

**D901155ZR**  
Tracer point T20

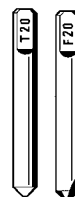

**D701156ZB**  
Cutter F20

FOR:

**KABA (CH)**

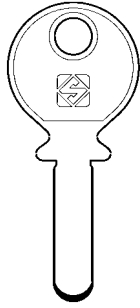

**KA5**

OPTIONAL

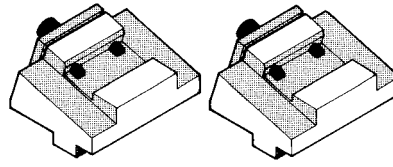

**D701472ZB**

*15° adaptors for KABA GEMINI*

STANDARD



**D901070ZR**

*Tracer point T1*



**D701071ZB**

*Cutter F1*

FOR:

**KABA (CH)**

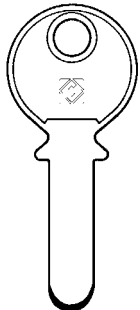

**KA2**



**NIKABA (J)**

OPTIONAL

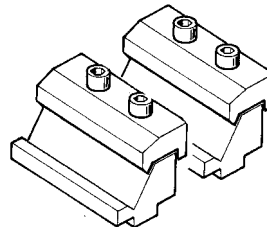

**D701471ZB**

*Adaptors 45°*

STANDARD



**D908987ZR**

*Tracer point T43*

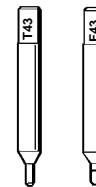

**D708988ZB**

*Cutter F43*

**D901070ZR**

*Tracer point T1*

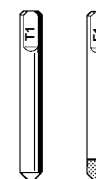

**D701071ZB**

*Cutter F1*

# MATRIX S

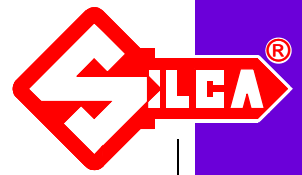

FOR: **KESO (CH)**

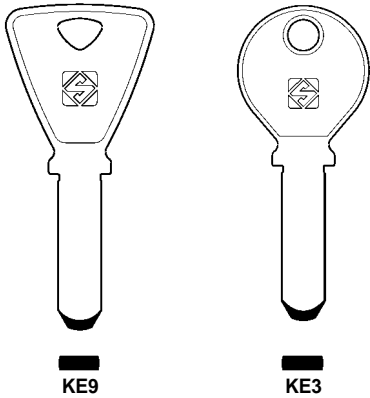

KESO 2000

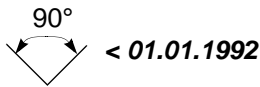

OPTIONAL



**D901078ZR**  
Tracer point T5



**D701079ZB**  
Cutter F5

**D903232ZR**  
Tracer point T14



**D703233ZB**  
Cutter F14

FOR: **KESO (CH)**

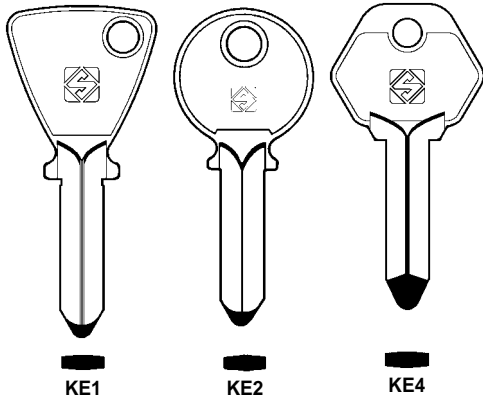

KESO 1000

OPTIONAL

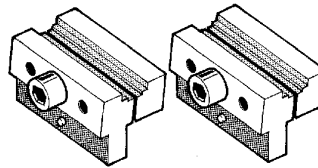

**D701470ZB**  
5° adaptors



**D901070ZR**  
Tracer point T1



**D701071ZB**  
Cutter F1

OPTIONAL

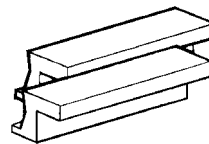

**D701068ZB**  
Adattatori 5°-dorso



**D901082ZR**  
Tracer point T7

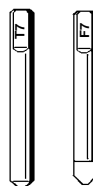

**D701083ZB**  
Cutter F7



# MATRIX S

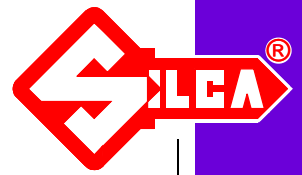

FOR:

**LIPS (NL)**

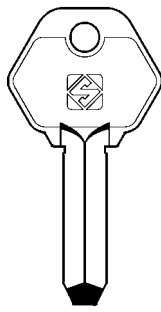

LP11

OPTIONAL

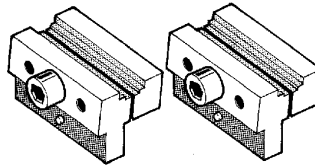

**D701470ZB**  
5° adaptors



**D901070ZR**  
Tracer point T1



**D701071ZB**  
Cutter F1

OPTIONAL

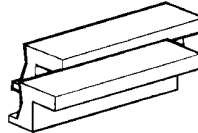

**D701068ZB**  
5° adaptors-back



**D901082ZR**  
Tracer point T7



**D701083ZB**  
Cutter F7

FOR:

**LAPERCHE (F)**

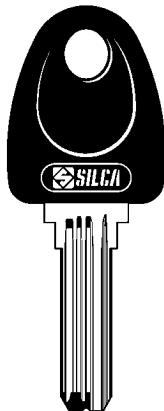

LH15P

LH17P

LH16P

LH14P

LH18P

OPTIONAL



**D907164ZR**  
Tracer point T40

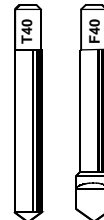

**D707165ZB**  
Cutter F40

FOR:

**LAPERCHE (F)**

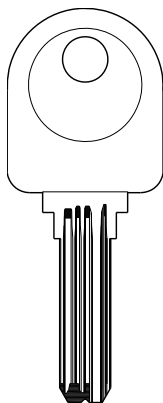

DIAM

OPTIONAL



**D907164ZR**  
Tracer point T40

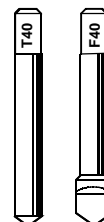

**D707165ZB**  
Cutter F40





FOR:

**LEHMANN (D)**

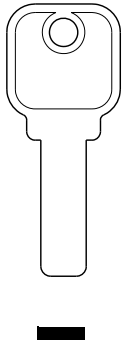

OPTIONAL



**D902098ZR**  
Tracer point T13

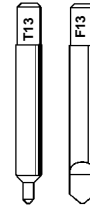

**D702099ZB**  
Cutter F13

FOR:

**MCM (E)**

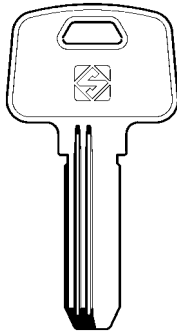

**MC10R**

OPTIONAL

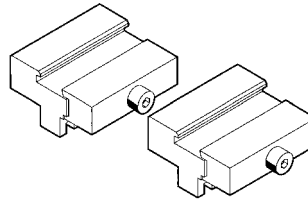

**D711137ZB**  
Adaptors for MCM key

**D711145ZB**  
Tracer point T50

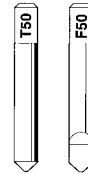

**D711144ZB**  
Cutter F50

FOR:

**MCM (E)**

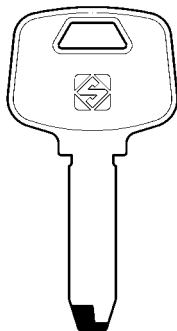

**MC9**

OPTIONAL



**D906656ZR**  
Tracer point T38

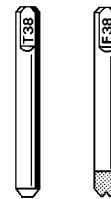

**D706657ZB**  
Cutter F38

**D906653ZR**  
Tracer point T37

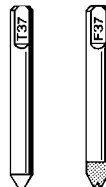

**D706654ZB**  
Cutter F37

**D906658ZR**  
Tracer point T39

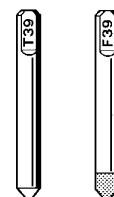

**D706659ZB**  
Cutter F39

# MATRIX S

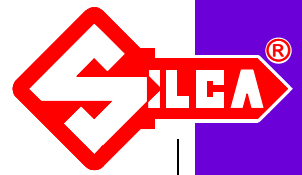

FOR: **MEDECO (USA)**

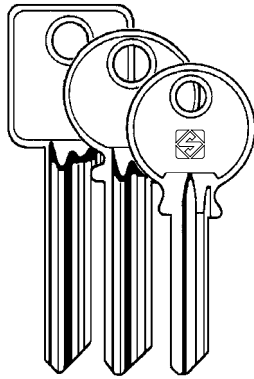

**MD1R**

OPTIONAL

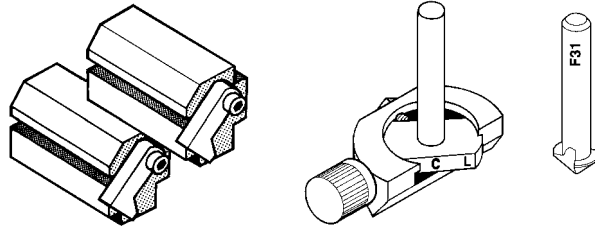

**D705711ZB**  
Set for MEDECO keys

FOR: **MERONI (I)**

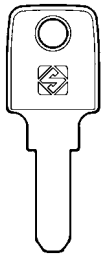

**MER39**

OPTIONAL

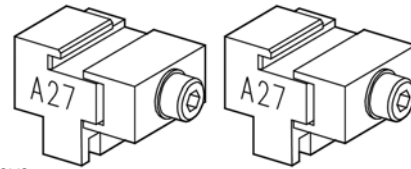

**D736265B**  
Adapters A27 for Meroni keys

**D909147ZR**  
Tracer point T44

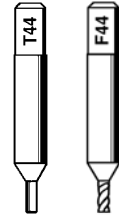

**D709148ZB**  
Cutter F44

FOR: **MG-MONTI (I)**

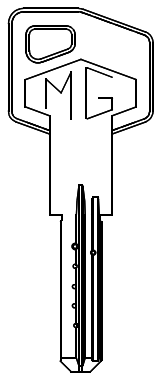

**(HSP)**

OPTIONAL

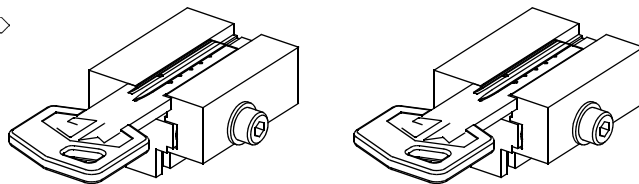

**D724811ZB**  
Adapters for MG-MONTI keys

STANDARD



**D906658ZR**  
Tracer point T39

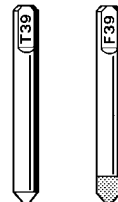

**D706659ZB**  
Cutter F39



# MATRIX S

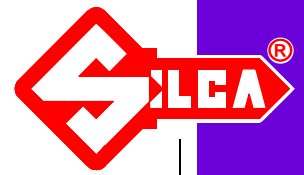

FOR:

## MOTTURA (I)

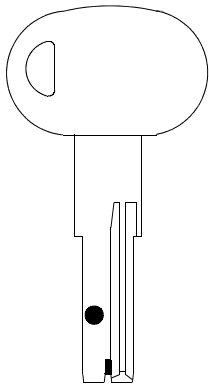

C30 C31 C38

**Champions System**

OPTIONAL



**D722575ZB**  
Tracer point T138

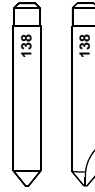

**D722573ZB**  
Cutter H138

**D724358ZB**  
Pair of bars

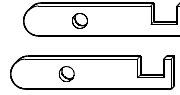

Only for C38 System

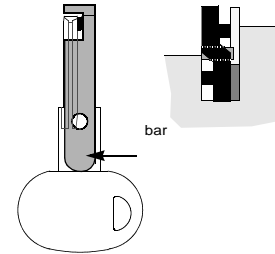

FOR:

## MUL.T.LOCK (IL)

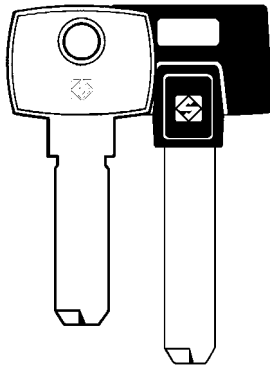

MTK1 MTK2P  
MTK3P

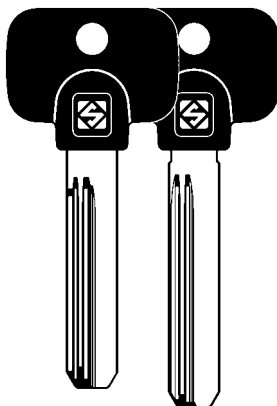

MTK10RP MTK4RPX  
MTK4P MTK7RP  
MTK4RP MTK8RP

OPTIONAL

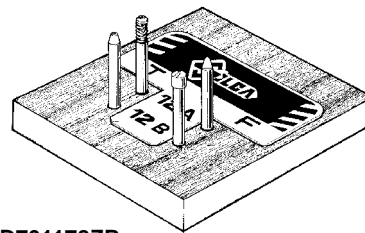

**D701178ZB**  
Tool set for Mul.T.Lock keys



**D706965ZB**  
Shims  
Set spessori  
Zwischenlegscheibensatz  
Épaisseurs  
Planchitas

**D901090ZR**  
Tracer point T12A

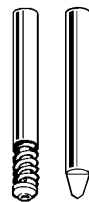

**D701091ZB**  
Cutter F12A

**D901092ZR**  
Tracer point T12B

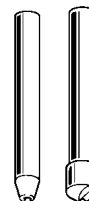

**D701093ZB**  
Cutter F12B



FOR: **PERINO (I)**

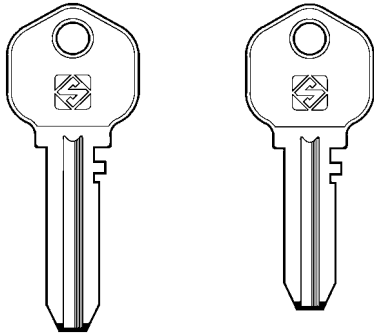

PN1    PN1R    PN2

OPTIONAL

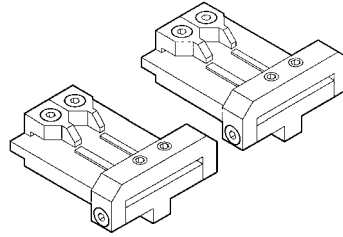

**D711218ZB**  
Adaptors for PERINO keys

**D904168ZR**  
Tracer point T11L

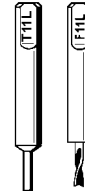

**D704449ZB**  
Cutter F11L

FOR: **PICARDIE (F)**

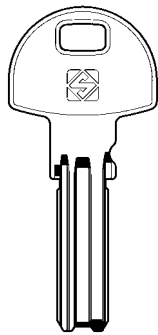

PIC2

STANDARD



**D901070ZR**  
Tracer point T1

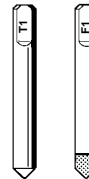

**D701071ZB**  
Cutter F1

FOR: **POTENT (I)**

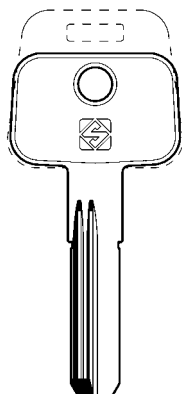

PT4R

OPTIONAL



**D910149ZR**  
Tracer point T49

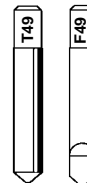

**D710150ZB**  
Cutter F49

FOR:

## PREFER (I) RBZ (I)

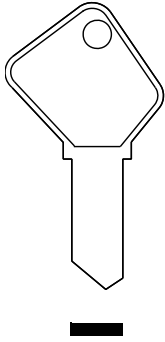

OPTIONAL



**D901074ZR**  
Tracer point T3



**D701075ZB**  
Cutter F3



STANDARD



**D901070ZR**  
Tracer point T1

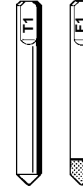

**D701071ZB**  
Cutter F1



FOR:

## SEA (CH)

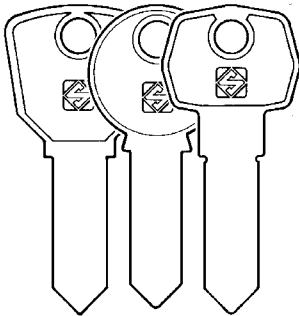

**SEB1 SEB2 SEB3**  
SEA 23 SEA SEA 3  
SEA 20 SEA 2 SEA 2

EZCURRA (E)

OPTIONAL



**D901074ZR**  
Tracer point T3



**D701075ZB**  
Cutter F3



STANDARD



**D901070ZR**  
Tracer point T1

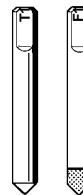

**D701071ZB**  
Cutter F1



for SEB1 - SEB3 only



FOR:

## SECUREMME (I)

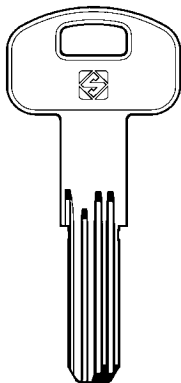

SCM2

OPTIONAL



**D734535ZB**  
Adapters A21 for SECUREMME keys

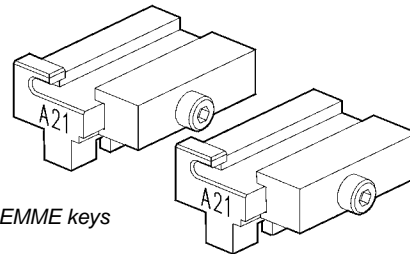

OPTIONAL



**D711418ZB**  
Tracer point T55

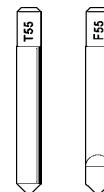

**D711419ZB**  
Cutter F55

# MATRIX S

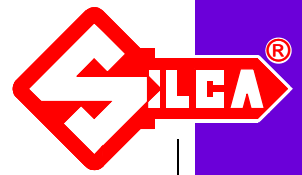

FOR:

## SECURITAL (I)

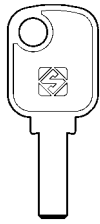

SCU1

KYR (I)

OPTIONAL

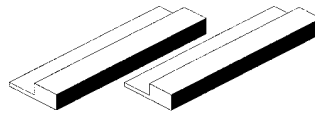

**D710008ZB**  
Adaptors

**D901155ZR**  
Tracer point T20



**D701156ZB**  
Cutter F20

FOR:

## STS (E)

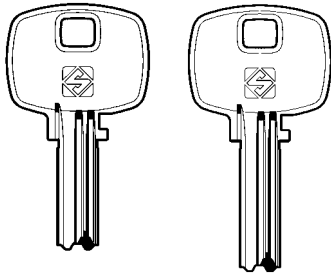

STS5

STS6

OPTIONAL

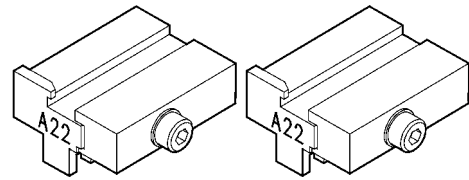

**D734670ZB**  
Adaptors A22 for STS keys

OPTIONAL



**D711418ZB**  
Tracer point T55

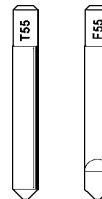

**D711419ZB**  
Cutter F55

FOR:

## TESA (E)

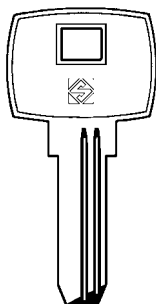

TE4  
T10

TE4R

OPTIONAL



**D908799ZR**  
Tracer point T42



**D708800ZB**  
Cutter F42



# MATRIX S

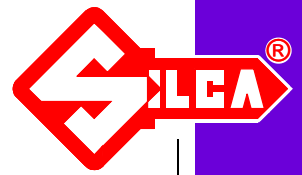

FOR: **TESA (E)**

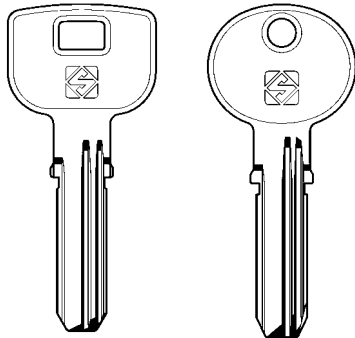

  
TE5  
T80

  
TE7  
T60

OPTIONAL



**D901078ZR**  
Tracer point T5

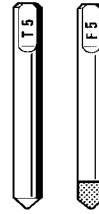

**D701079ZB**  
Cutter F5

FOR: **VACHETTE (F)**

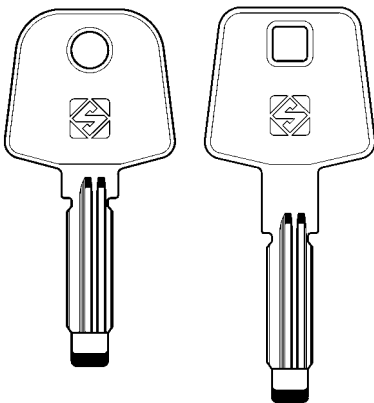

  
VAC91

  
VAC104

  
VAC103

  
VAC105

"VACHETTE RADIAL"

OPTIONAL

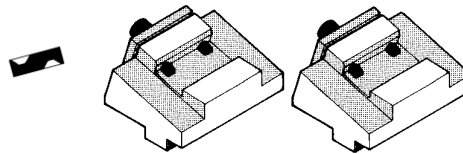

**D701472ZB**  
15° adaptors

**D905113ZR**  
Tracer point T21

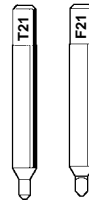

**D705114ZB**  
Cutter F21

FOR: **VIRO (I)**

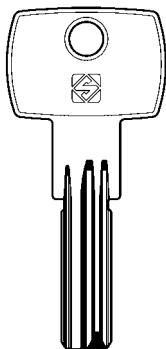

  
VI19

OPTIONAL



**D901078ZR**  
Tracer point T5



**D701079ZB**  
Cutter F5





FOR:

**WILKA (D)**

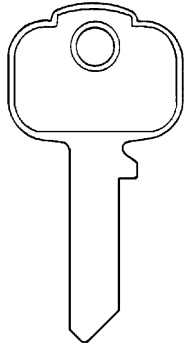

OPTIONAL

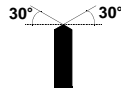

**D705731ZB**

Adaptors for WILKA - 30°

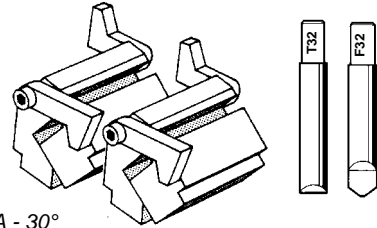

FOR:

**WILKA (D)**

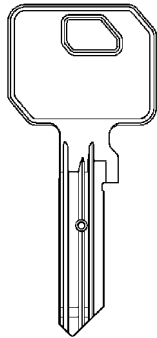

**TH6**  
(TH6)

OPTIONAL



**D735976ZB**

Adaptors A25 for Wilka TH6 keys

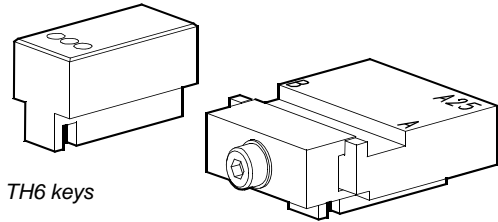

**D735980ZB**

Tracer point T67

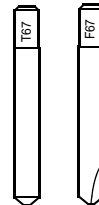

**D735979ZB**

Cutter F67

FOR:

**WINKHAUS (D)**

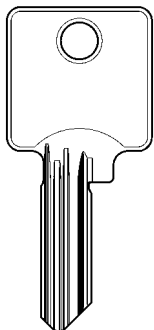

**VS**  
(Kalotten System)  
(VS + VS6)

TOK-WINKHAUS

OPTIONAL

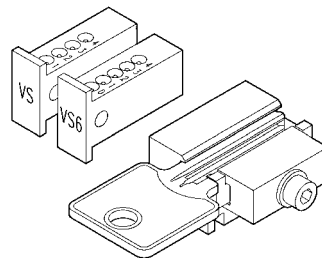

**D711596ZB**

Code set for WINKHAUS

**D901080ZR**

Tracer point T6

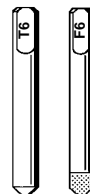

**D701081ZB**

Cutter F6

FOR:

**YARDENI (IL)**

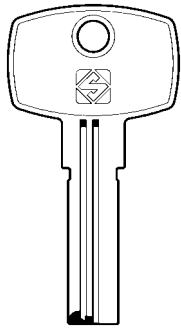

YD6R

OPTIONAL

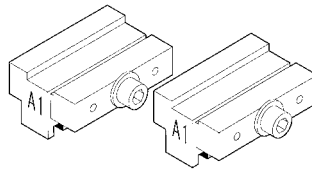

**D710145ZB**  
*Adaptors for YARDENI*

**D910149ZR**  
*Tracer point T49*

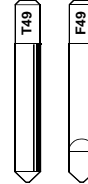

**D710150ZB**  
*Cutter F49*

FOR:

**ZADI (I)**

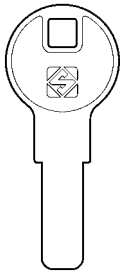

ZD20

OPTIONAL



**D901078ZR**  
*Tracer point T5*

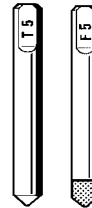

**D701079ZB**  
*Cutter F5*

FOR:

**ZADI (I)**

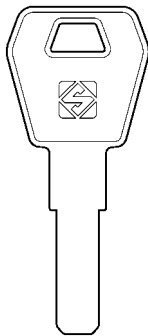

ZD25

OPTIONAL



**D909147ZR**  
*Tracer point T44*

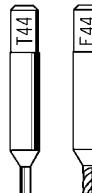

**D709148ZB**  
*Cutter F44*

# MATRIX S

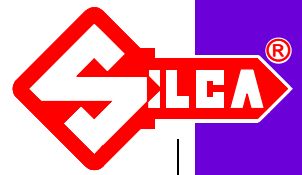

FOR: **ALFA ROMEO (I)**

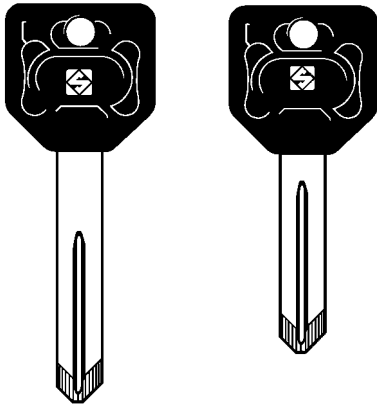

GT2AP  
GIOBERT (I)  
SAFE (I)

GT9AP

OPTIONAL



D901080ZR  
Tracer point T6



D701081ZB  
Cutter F6

FOR: **BMW (D)**

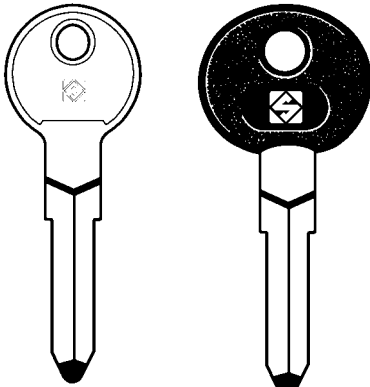

PB1

PB1P

OPTIONAL

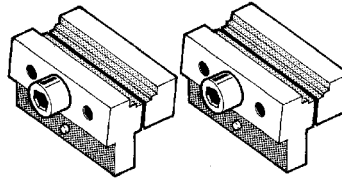

D701470ZB  
5° adaptors

Adaptadores 5°

STANDARD



D901070ZR  
Tracer point T1

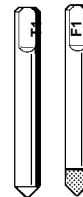

D701071ZB  
Cutter F1

FOR: **BMW (D)**

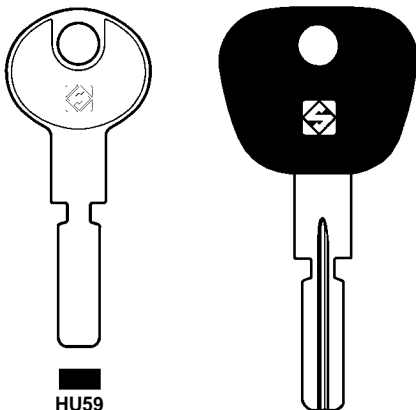

HU59

HU63

HU58AP

HUF (D)  
TIBBE (D)

OPTIONAL

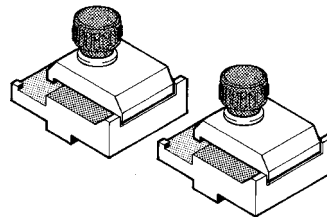

D701664ZB  
Adaptors

STANDARD



D905487ZR  
Tracer point T22



D705488ZB  
Cutter F22

OPTIONAL



D708765ZB  
Code attachment

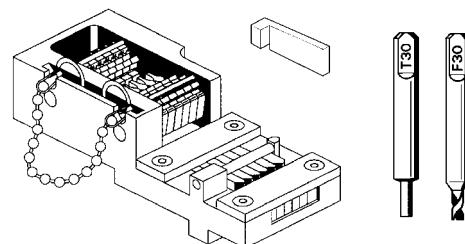

# MATRIX S

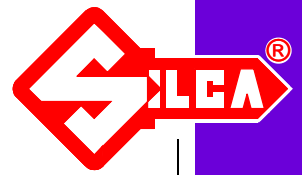

FOR: **FORD (EU)**

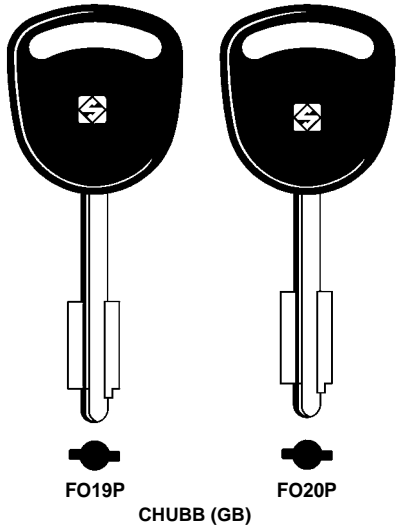

FO19P  
FO20P  
CHUBB (GB)

OPTIONAL

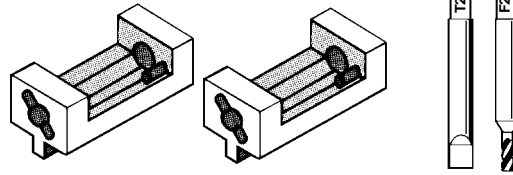

**D705484ZB**  
Adaptors for FO19P-FO20P keys

FOR: **FORD (EU + USA)**

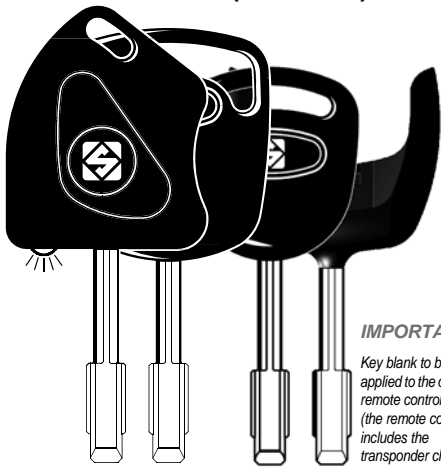

FO21T3L  
FO21T3  
FO21P  
FO21AP  
FO21PL  
TIBBE (D)  
VALEO (F)

**IMPORTANT!**  
Key blank to be applied to the original remote control (the remote control includes the transponder chip)

OPTIONAL

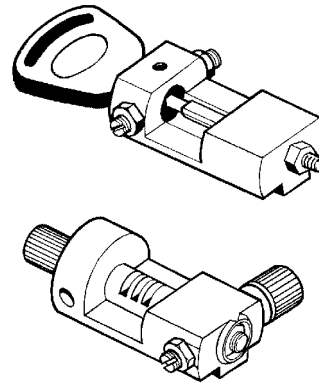

**D705485ZB**  
Code attachment

FOR: **HONDA (J)**

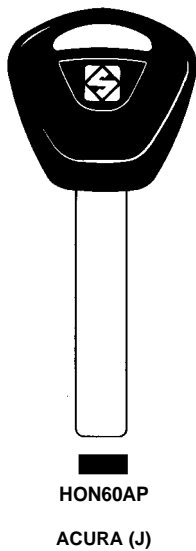

HON60AP  
ACURA (J)

OPTIONAL

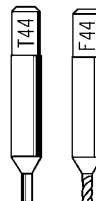

**D909147ZR**  
Tracer point T44

**D709148ZB**  
Cutter F44



# MATRIX S

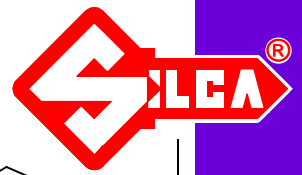

FOR:

## HONDA (J)



HON66GP

HON66T5  
HON66T6  
HON66T14  
HOV01T5

OPTIONAL

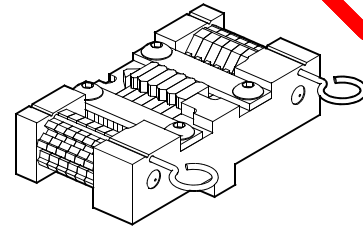
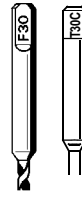

**D722722ZB**

Code device for HON66GP keys

STANDARD



**D905487ZR**

Tracer point T22



**D705488ZB**

Cutter F22

FOR:

## HOLDEN (AUS)

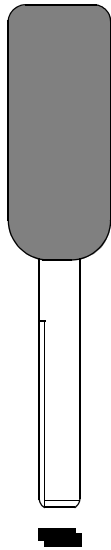

OPTIONAL

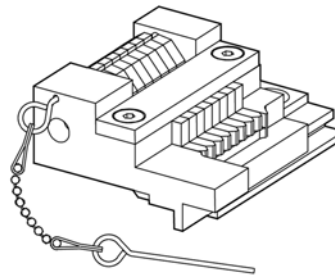

**D731969ZB**

Code device

STANDARD



**D905487ZR**

Tracer point T22



**D705488ZB**

Cutter F22

OPTIONAL



**D909147ZR**

Tracer point T44

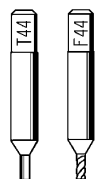

**D709148ZB**

Cutter F44



# MATRIX S

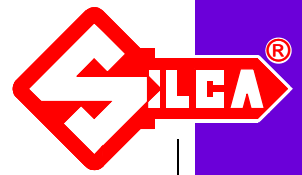

FOR:

HUF (D)

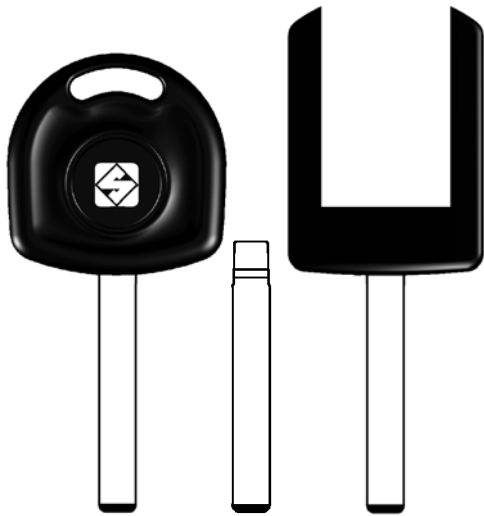

HU100T12

HU100T

HU100BT12

HU100AT12

OPTIONAL

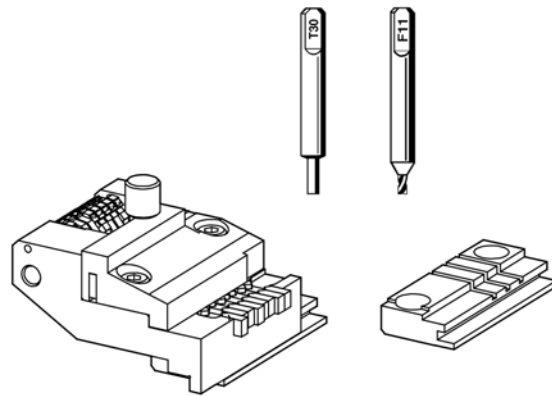

**D736700ZB**

Device for code-cutting HU100 keys

FOR:

HUF (D)

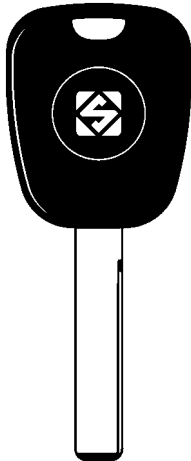

HU92RP

OPTIONAL

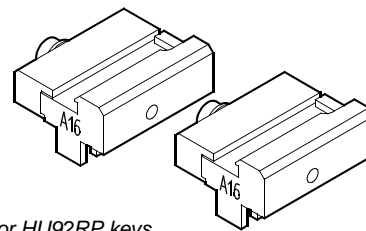

**D727645ZB**

Adaptors A16 for HU92RP keys

OPTIONAL



**D901159ZR**  
Tastatore T30



**D701160ZB**  
Fresa F30



# MATRIX S

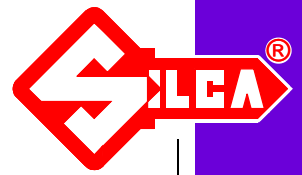

FOR:

**HUF (D)**

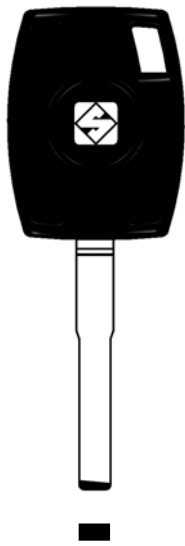

OPTIONAL

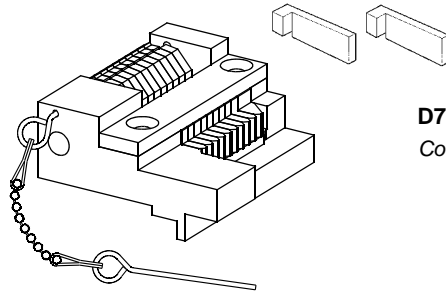

**D728161ZB**  
Code device

OPTIONAL



**D901159ZR**  
Tastatore T30

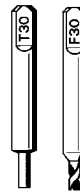

**D701160ZB**  
Fresa F30

FOR:

**JAGUAR (GB)**

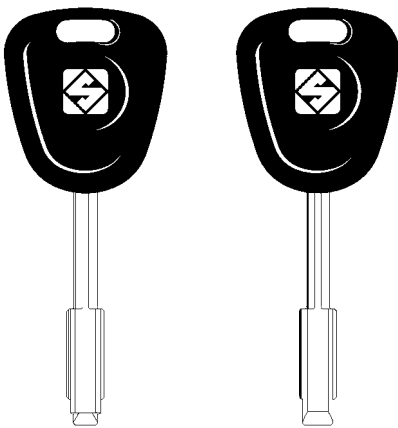

**TBE1P**

**TBE1T5**

**TBE2P**

**TIBBE (D)**  
**VALEO (F)**

OPTIONAL

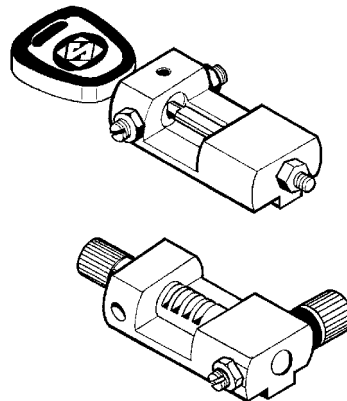

**D707657ZB**  
Code attachment





# MATRIX S

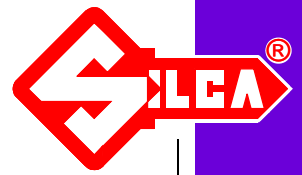

FOR:

**LANCIA (I)**

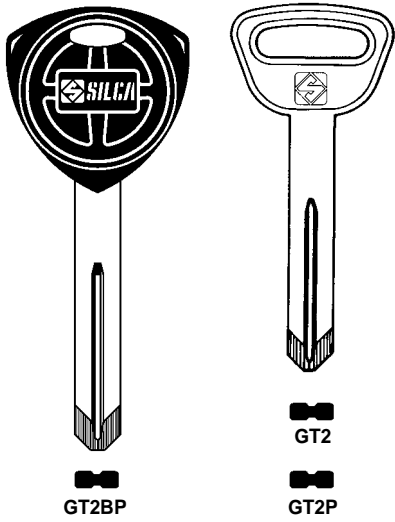

GT2BP

GT2

GT2P

GIOBERT (I)

OPTIONAL



**D901080ZR**  
Tracer point T6



**D701081ZB**  
Cutter F6

FOR:

**LEXUS (J)**



TOY40P TOY40AP TOY40 TOY40BT4

TOYOTA (J)

OPTIONAL

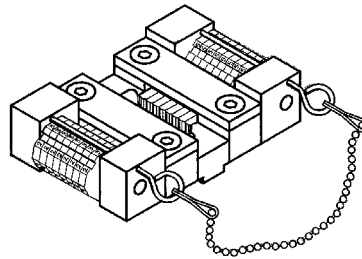

**D708165ZB**  
Code attachment



FOR:

**MAZDA (J)**

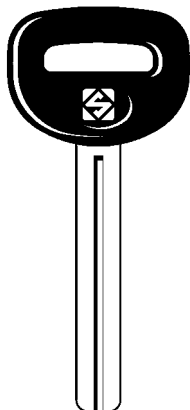

MAZ23LP

OPTIONAL

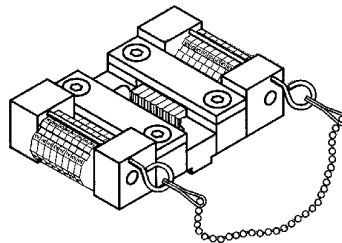

**D708165ZB**  
Code attachment



# MATRIX S

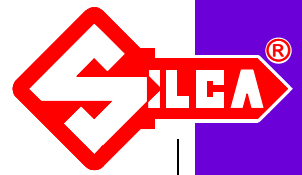

FOR: **MERCEDES (D)**

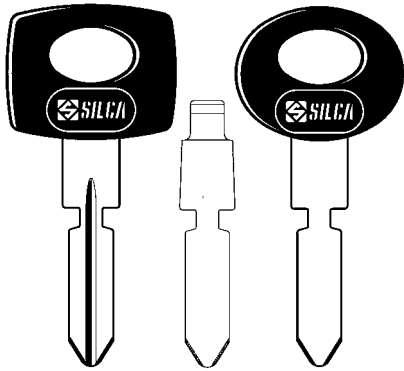

HU39P      HU39T      HU40P  
HUF (D)

OPTIONAL

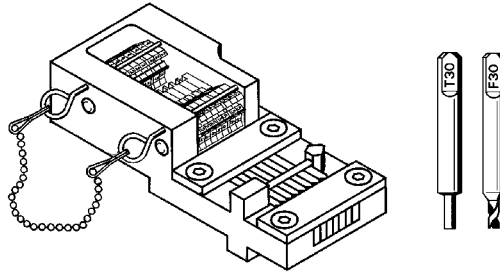

**D708225ZB**  
Code attachment for HU39P-HU40P keys

FOR: **MERCEDES (D)**

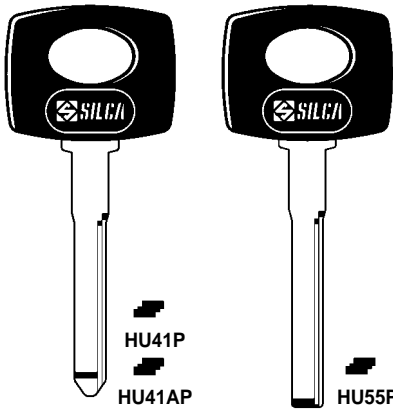

HU41P      HU55P  
HU41AP

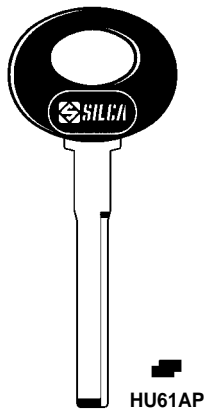

HU61AP

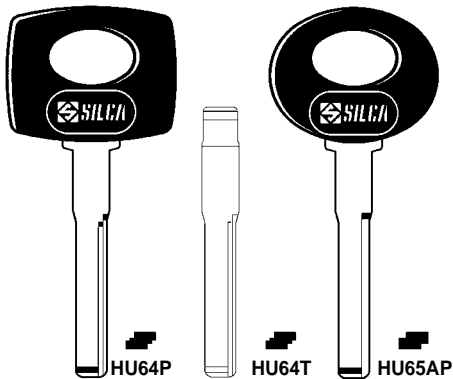

HU64P      HU64T      HU65AP  
HUF (D)

OPTIONAL

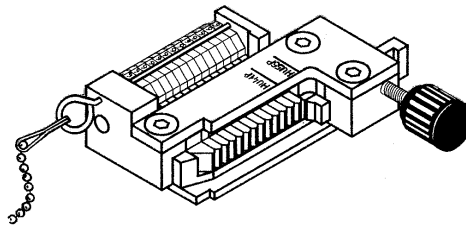

**D708150ZB**  
Code attachment



# MATRIX S

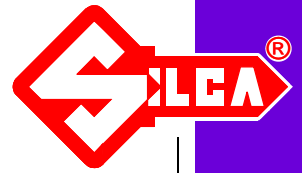

FOR:

**MITSUBISHI (J)**



  
MIT14T5

OPTIONAL

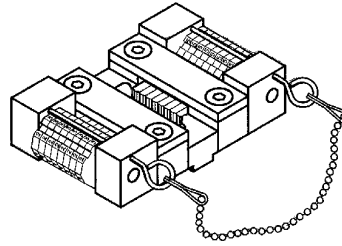

**D708165ZB**  
Code attachment

FOR:

**MITSUBISHI (J)**

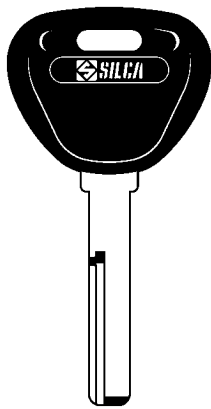

  
HU56RT2

HUF (D)

OPTIONAL



**D705671ZB**  
Code device

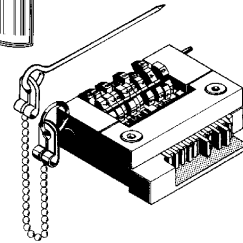



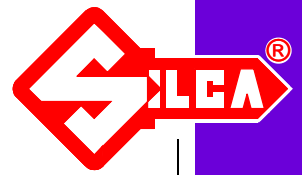



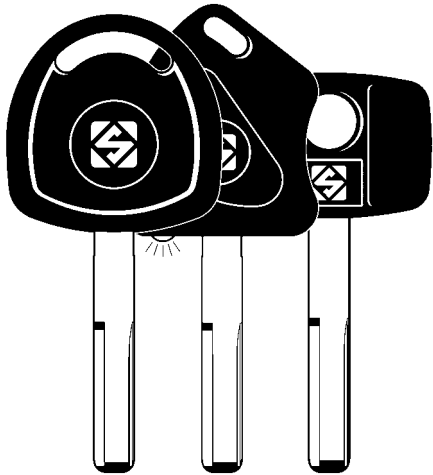

# MATRIX S



FOR: OPEL-VAUXHALL (D)

OPTIONAL



 HU43T9  
 HU43AT9  
 HU43T  
 HU43TGM  
 HU43T2L  
 HU43PL  
 HU43P

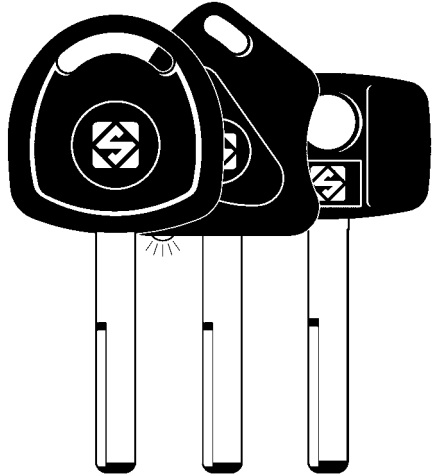

 YM27T2  
 YM27PL  
 YM27P

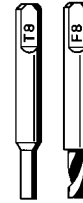
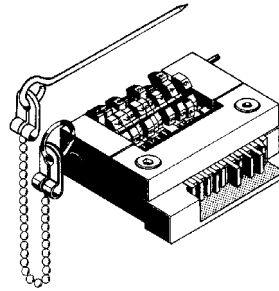

**D706272ZB**  
Code device

FOR: RAITON FISSORE (I)

OPTIONAL

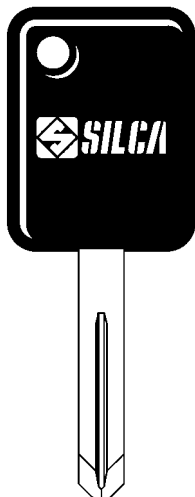

 GT2CP

**D901080ZR**  
Tracer point T6



**D701081ZB**  
Cutter F6





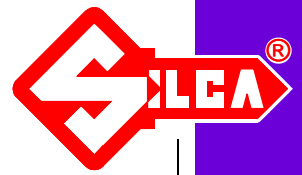

# MATRIX S

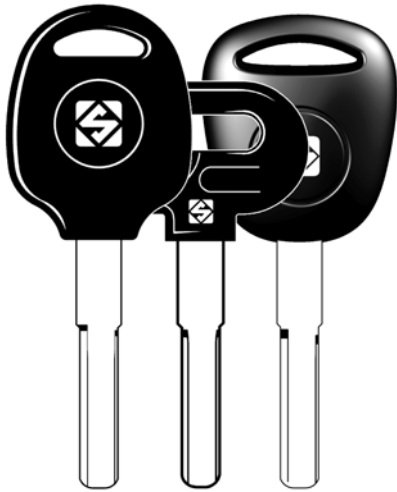

FOR:

**SAAB (S)**



 **YM30BP**  
 **YM30P**  
 **YM30T5**  
**VALEO-YMOS (D)**      **YMOS (D)**

OPTIONAL

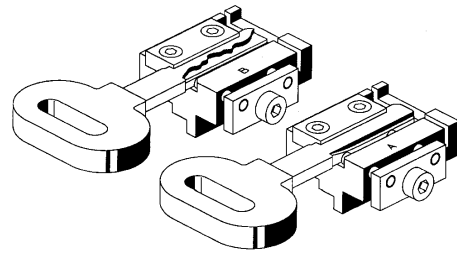

**D708910ZB**  
Adaptors

STANDARD



**D905487ZR**  
Tracer point T22



**D705488ZB**  
Cutter F22

FOR:

**TOYOTA (J)**



 **TOY48P**  
 **TOY48BT4**

ARISTO

OPTIONAL

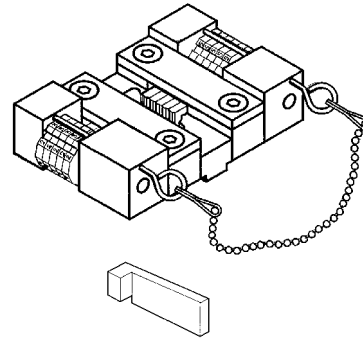

**D714518ZB**  
Code attachment

**D905487ZR**  
Tracer point T22



**D705488ZB**  
Cutter F22



# MATRIX S

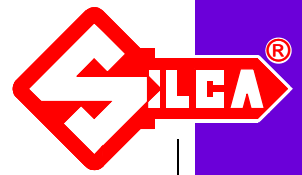

FOR:

**VOLVO (S)**

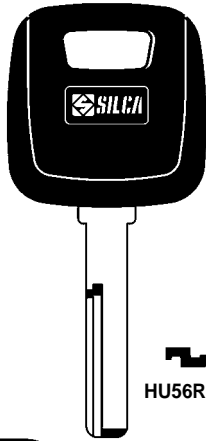

**HU56RAT2**

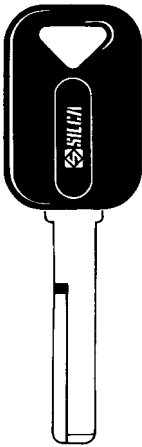

**HU57RP**

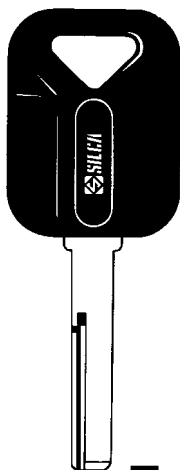

**HU56RP**

OPTIONAL

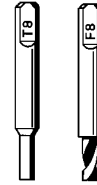
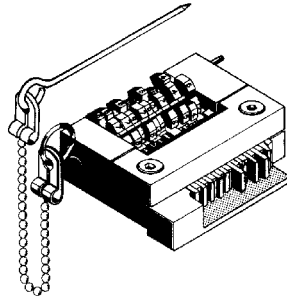

**D705671ZB**  
Code device

FOR:

**AUDI (D)  
FORD (D)  
PORSCHE (D)  
SEAT (E)  
SKODA (CZ)  
VOLKSWAGEN (D)**

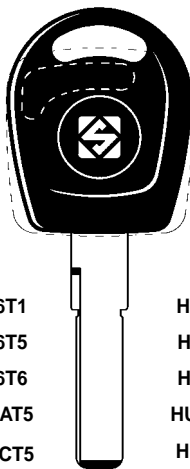

**HU66T1  
HU66T5  
HU66T6  
HU66AT5  
HU66CT5  
HU66DT5  
HU66CT6**

**HU66AT6  
HU66T10  
HU66T15  
HU66BT15  
HU66BT1  
HU66PL  
HU66T5L  
HU75T  
HU103T**

**HUF (D)  
WITTE (D)**

OPTIONAL

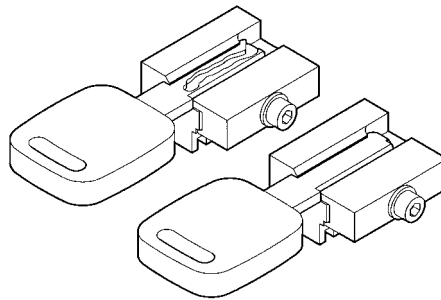

**D711803ZB**  
Adaptors for keys with internal cuts

**D901159ZR**  
Tracer point T30



**D701160ZB**  
Cutter F30



# MATRIX S

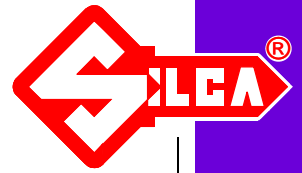

FOR:

AUDI (D)  
FORD (D)  
PORSCHE (D)  
SEAT (E)  
SKODA (CZ)  
VOLKSWAGEN (D)

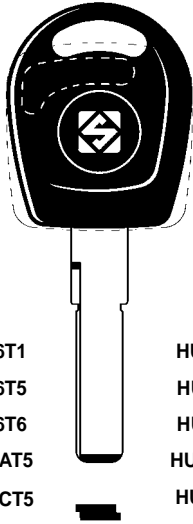

HU66T1	HU66AT6
HU66T5	HU66T10
HU66T6	HU66T15
HU66AT5	HU66BT15
HU66CT5	HU66BT1
HU66DT5	HU66PL
HU66CT6	HU66T5L
	HU75T
	HU103T

OPTIONAL

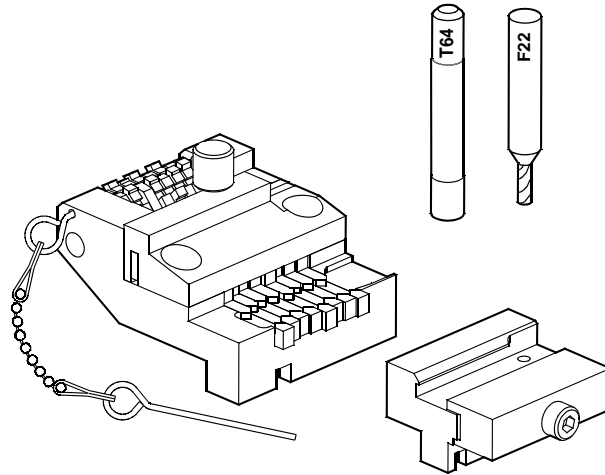

**D727306ZB**

*Device for code-cutting*

