

PART #	DESCRIPTION
58747C	10-UP FJ/4RNR/10-UP GX EXT TRAVEL 2.5 VS RR CDCV COILOVER KIT

COMPONENTS INCLUDED	
(1) 154004 05+ TACO / FJ RESI MOUNT (PASS) (1) 154005 05+ TACO / FJ RESI MOUNT (DRVR) (1) 154953CD 07+ FJ/03+ 4RUNNER EXT TRAVEL CO RR CDCV (DRVR) (1) 154953CP 07+ FJ/03+ 4RUNNER EXT TRAVEL CO RR CDCV (PASS)	(4) 605144 3/8-12 X .750 FLANGED SELF TAP BOLTS (1) 611019 COILOVER HARDWARE KIT (PAIR) (1) 611031 10+ SWAYBAR RELOCATION KIT (1) 611051 HOSE CLAMP KIT
HARDWARE INCLUDED	
611019 HARDWARE KIT	
(6) 605101 3/8-16 X 1.000 BOLT	(6) 605131 3/8" SPLIT LOCK WASHER
611031 HARDWARE KIT	
(2) 157110 10+ SWAYBAR BRACKET (14) 605432 9/16 WASHER THICK 1.18 X .585 X .18 (4) 605100 3/8-16 X .750 BOLT	(4) 605133 3/8" FLAT WASHER (4) 605808 M10-1.25 X 25MM (2) 605853 M10-1.25 X 25MM FLANGED BOLT
611051 HARDWARE KIT	
(4) STAINLESS STEEL HOSE CLAMP	
TOOLS REQUIRED	
JACK JACK STANDS TORQUE WRENCH HAMMER DRILL (KDSS ONLY) 11/32" DRILL BIT (KDSS ONLY) 5/16" NUT DRIVER 9/16" SOCKET / WRENCH	ANGLE GRINDER (KDSS ONLY) 8MM ALLEN WRENCH 10MM SOCKET / WRENCH 13MM SOCKET / WRENCH 14MM SOCKET / WRENCH 15MM SOCKET / WRENCH 18MM SOCKET / WRENCH 21MM SOCKET / WRENCH
TECH NOTES	
<p>1. YOUR ICON COILOVER ASSEMBLIES COME FACTORY CHARGED TO 150 PSI. RELEASING NITROGEN PRESSURE MAY LEAD TO SHOCK MALFUNCTION AND REDUCED RIDE QUALITY. FAILURE CAUSED BY LOW NITROGEN PRESSURE IS NOT COVERED UNDER ICON'S WARRANTY POLICY.</p> <p>2. YOUR ICON COILOVER ASSEMBLIES COME SHIPPED AT ICON'S RECOMMENDED RIDE HEIGHT. DO NOT PRELOAD THE COIL BEYOND 2.13" (1.13" FOR 700LB COIL #158508) OF EXPOSED THREADS BETWEEN THE BOTTOM OF THE TOP CAP AND THE TOP OF THE COIL ADJUSTER NUT. A REDUCTION IN RIDE QUALITY WILL BE EXPERIENCED IF COILOVERS ARE ADJUSTED TO ALLOW FOR LESS THAN 2" OF DROOP TRAVEL FROM STATIC RIDE HEIGHT.</p> <p>3. KDSS EQUIPPED VEHICLES WILL REQUIRE THE SYSTEM TO BE DEACTIVATED BEFORE INSTALLATION, AND REACTIVATED AFTER INSTALLATION IS COMPLETE. REFER TO FACTORY SERVICE MANUAL FOR MORE INFORMATION.</p> <p>4. KDSS EQUIPPED VEHICLES WILL NOT USE SWAYBAR RELOCATION KIT (611031).</p> <p>5. REQUIRES USE OF ICON TUBULAR UPPER CONTROL ARM (58451) OR ICON BILLET UPPER CONTROL ARM (58551).</p>	

WARNING!

**** READ ALL INSTRUCTIONS THOROUGHLY FROM START TO FINISH BEFORE BEGINNING INSTALLATION! IF THESE INSTRUCTIONS ARE NOT PROPERLY FOLLOWED SEVERE FRAME, SUSPENSION AND TIRE DAMAGE MAY RESULT TO THE VEHICLE!**

**** ICON VEHICLE DYNAMICS RECOMMENDS THAT YOU EXERCISE EXTREME CAUTION WHEN WORKING UNDER A VEHICLE THAT IS SUPPORTED WITH JACK STANDS.**

****ICON VEHICLE DYNAMICS RECOMMENDS ALL INSTALLATION TO BE PERFORMED BY A PROFESSIONAL SHOP/SERVICE TECHNICIAN. PRODUCT FAILURE CAUSED BY IMPROPER INSTALLATION WILL NOT BE COVERED UNDER ICON'S WARRANTY POLICY.**

INSTALLATION

1. If your vehicle is equipped with Kinetik Dynamic Suspension System (KDSS), deactivate the system before performing ANY work to the vehicle. Refer to the factory service manual for information on how to deactivate this system. KDSS will need to be reactivated once the installation is complete.
2. Using a properly rated jack, raise the front of the vehicle and support the frame rails with jack stands. Ensure the jack stands are secure and set properly before lowering the jack. NEVER WORK UNDER AN UNSUPPORTED VEHICLE. Remove the front wheels.
3. Disconnect the outer tie rod end on both sides. Remove the cotter pin and loosen the nut until it is flush with the end of the threads. Strike the end of the steering knuckle arm with a large hammer to dislodge the taper. Remove the nut and swing the tie rod out of the way.

4. Remove the plastic upper skid plate using a 10mm and a flat head screwdriver. Remove the lower skid plate using a 12mm. Remove the skid plate braces using a 15mm. [FIGURE 1 - 3]

FIG.1



FIG.2



FIG.3



5. (NON KDSS VEHICLES ONLY) Disconnect the sway bar from the frame on both sides. Remove bolts using a 14mm socket/wrench and remove the bracket from the sway bar. Move the sway bar forward to make room for removal and installation of the shock.

6. To make room for removal of the factory coilover assembly, disconnect the knuckle from the upper control arm. Once the knuckle is disconnected from the upper control arm, support the knuckle so that brake line damage does not occur.

7. Support the lower control arm with a jack and remove the (3) nuts securing the upper shock assembly mount to the coil bucket. Do not loosen or remove the large center nut securing the spring seat to the shock shaft. Failure to comply will result in the stock coil assembly to come apart violently, causing damage to components and possible injury.

8. Loosen the bolt connecting the shock to the lower control arm. Lower jack and remove the bolt. Note orientation; as this bolt will be reused. The head of the bolt should be facing forward.

9. Remove the stock coil assembly. Due to rubber bushing stiffness you may need to pull down on the suspension. Be careful not to damage any brake lines or wires that may be routed down the upper control arm.

10. Install new coilover assembly. Install upper mount with the reservoir hose pointing outward using (605101) bolts and (605131) lock washers. [Torque to 35 ft-lbs]

11. Install lower shock mount to lower control arm: The lower shock mount has (1) long and (1) short spacer. Make sure the long spacer is toward the front of the vehicle. This will position the shock further toward the rear of the lower control arm to ensure adequate sway bar clearance. Reinstall the factory lower shock bolt. [Torque to factory spec] [FIGURE 4]

FIG.4



12. If replacing the upper control arms, refer to appropriate UCA instructions now. Mount the upper control arm to the knuckle and tighten the taper nut. [Torque to factory spec]

13. Reinstall the outer tie rod end [Torque to factory spec] and install cotter pin.

14. (SKIP TO STEP 16 FOR KDSS EQUIPPED VEHICLES) Remove the skid plate using a 14mm socket/wrench and set aside.

15. Install the reservoir mount and sway bar relocation block. Using the supplied socket head, bolt the block to the frame with the reservoir mount sandwiched between the relocation block and frame as shown. The heads will be recessed in the block. Make sure the block is positioned so that the new threaded holes are forward of the countersunk holes. Using the supplied (605100) bolts, (605133) washers and factory U-clamp, reinstall the sway bar in it's new position, forward of factory location. [FIGURE 5 & 6]

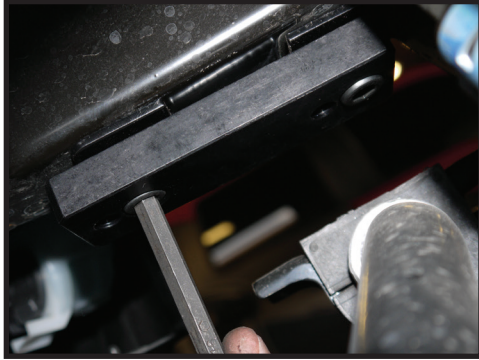

FIG.5

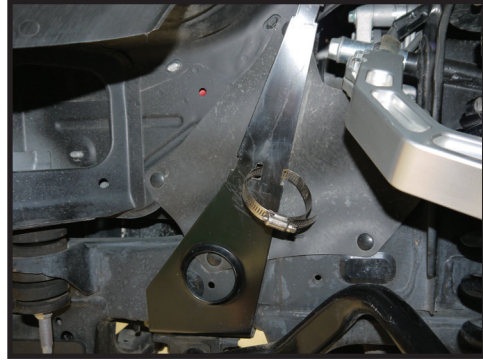

FIG.6

16. (KDSS ONLY) On KDSS equipped vehicles there is a tab located on the driver side frame rail of the vehicle. This tab will need to be cut off to allow for installation of the shock reservoir bracket (154005). [FIGURE 7]

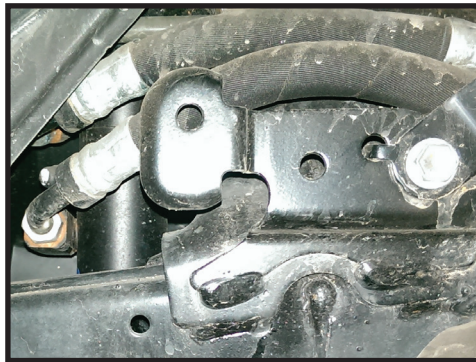

FIG.7

17. (KDSS ONLY) For vehicles equipped with Kinetic Dynamic Suspension System, each remote reservoir bracket will be mounted using two (605144) self-tapping bolts.

18. (KDSS ONLY) Hold the reservoir mounting bracket against the frame and mark the location of the hole on the lower part of the frame.

19. (KDSS ONLY) Move the reservoir mounting bracket away from the frame and drill an 11/32" hole in the center of the spot that you just marked.

20. (KDSS ONLY) Deburr the hole, place the reservoir and mount back against the frame, and install the self-tapping bolts.

21. Mount reservoir according to diagram for appropriate year and model. The lower hose clamp goes through the slot in the bracket and the upper registers in the notches at the top of the bracket. Position the reservoir so the clamp bands are in the recessed groove on the can and secure. [FIGURE 8 & 9]

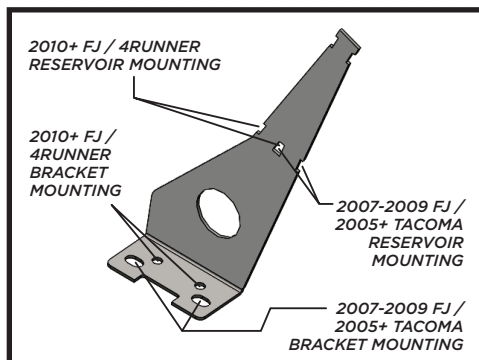

FIG.8



FIG.9

22. Install the skid plate braces with the supplied skid plate washers (605432) between the frame and skid plate on all six mounting locations. Use (2) washers per bolt with (3) washers on the bolts towards the front of the truck. Use the supplied (605853) hardware for the middle bolts that go into the protruding bung and the factory hardware for the remaining mounting locations and tighten with a 14mm socket/wrench. [Torque to factory spec] [FIGURE 10]

FIG.10

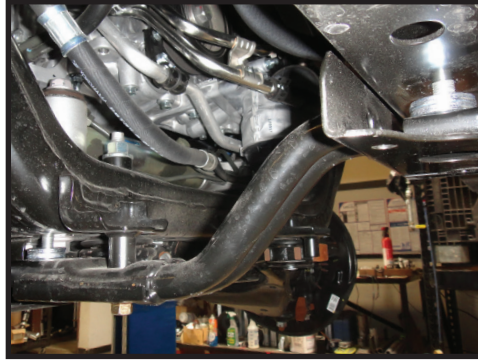

23. Slightly bend the hanger tabs down on the factory skid plate, they will no longer be used. [FIGURE 11]

FIG.11

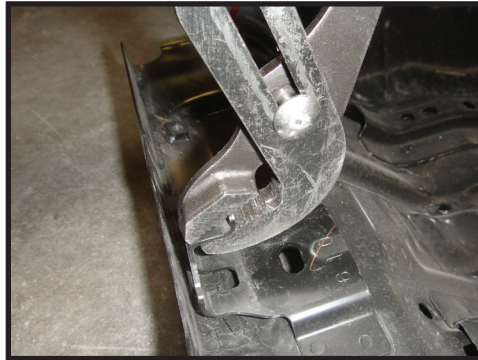

24. Install the OEM skid plate using the factory hardware and a 12mm. [FIGURE 12 & 13]

FIG.12



FIG.13

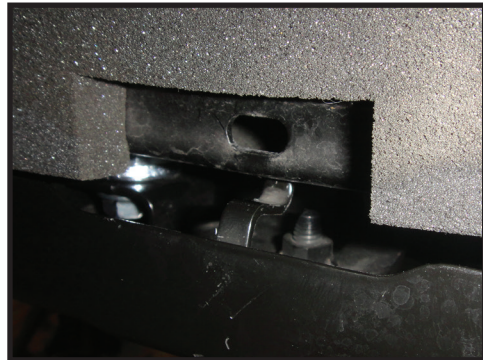

25. Install the plastic upper skid plate using the factory hardware and a 10mm. [FIGURE 14]

FIG.14



26. Install wheels and lower vehicle back to the ground. [Torque lugs to factory spec]

27. Have the vehicle professionally aligned.

FOR KDSS EQUIPPED VEHICLES: After completing installation of ICON components, refer to factory Toyota service manual to reset the KDSS system.

VERIFY ALL FASTENERS ARE PROPERLY TORQUED BEFORE DRIVING VEHICLE.

RETORQUE ALL NUTS, BOLTS AND LUGS AFTER 100 MILES AND PERIODICALLY THEREAFTER.

2.5 VS SERIES SHOCK & COILOVER TECHNICAL INFORMATION

MAINTENANCE

ICON shock absorbers are a high quality rebuildable race style shock absorber designed for optimal performance. With a unit of this caliber on your vehicle, routine maintenance is required to keep them looking and operating in like new condition. Residual oil and assembly lube may be present at all seal paths from the factory out of the box and is considered normal. Pooling of oil however is not acceptable at any time and one should contact the ICON dealer where purchased.

BELOW ARE GUIDELINES BASED ON HOW YOU USE YOUR VEHICLE BUT YOUR MILEAGE MAY VARY:

STREET USE:

- Send in for factory servicing every 40,000 miles or if a leak develops, ride quality decreases, or they begin to make excessive noise.
- Remove any buildup of road salt, mud, or debris from shocks and coil springs anytime accrued
- Clean with mild soap and water with each oil change or anytime you notice build up.
- Wax the cylinders yearly with automotive wax to prevent corrosion.
- Check nitrogen pressure yearly. (252004 charge needle assembly available at any ICON distributor)
- Check bearings for excessive wear yearly.
- **DO NOT** apply any type of lube to the upper and lower bearings.

STREET/DIRT:

- Send in for factory servicing every 15,000 miles or if a leak develops, ride quality decreases, or they begin to make excessive noise.
- Clean with mild soap and water with each oil change, offroad trip, or anytime you notice build up.
- Wax the cylinders yearly with automotive wax to prevent corrosion.
- Check nitrogen pressure each dirt outing. (252004 charge needle assembly available at any ICON distributor)
- Check bearings for excessive wear yearly.
- **DO NOT** apply any type of lube to the upper and lower bearings.

DIRT USE:

- Send in for factory servicing every 1,000 miles.
- Check nitrogen pressure each outing. (252004 charge needle assembly available at any ICON distributor)
- Remove any buildup of mud or debris from shocks and coil springs after every outing.



ICON VEHICLE DYNAMICS®
PERFORMANCE SUSPENSION SYSTEMS AND SHOCK ABSORBERS