

PART #	DESCRIPTION
53502	16-UP TACOMA IIC INSTALL KIT

COMPONENTS INCLUDED	
(1) 255600 IIC CONTROLLER (1) 255601 BLOCK OFF PLUG	(1) 255602 WIRE HARNESS (1) 254404 IIC MOUNT 3RD GEN TACOMA
HARDWARE INCLUDED	
(4) 605033 SELF DRILL SCREW (2) 605069 1/4-20 X 1.25 BOLT (2) 605984 RUBBER STRIP 1" X 3" ADHESIVE BACK (3) 605751 5/16 TERMINAL CONNECTOR (2) 605750 BUTT CONNECTOR (1) 255607 FUSE TAP LOW PROFILE MINI (1) 605753 LOW PROFILE MINI FUSE 2 AMP	(1) 255605-10 INLINE ATO FUSE HOLDER W/10 AMP FUSE (1) 605760 WIRE LOOM 1/4" X 6FT (50) 605926-BLK 5-1/2 X 0.14 NYLON CABLE TIE, BLACK (3) 605985 CABLE TIE HOLDER ADHESIVE MOUNT
SUPPLIED WITH SHOCKS	
(1) 255604-06 6-FT WIRE (1) 255604-08 8-FT WIRE	(1) 255604-18 18-FT WIRE (1) 255604-30 30-FT WIRE
TOOLS REQUIRED	
WIRE STRIPPER WIRE CRIMPER WIRE CUTTERS HEAT GUN	TORQUE WRENCH 12MM SOCKET / WRENCH 13MM SOCKET / WRENCH 7/16 SOCKET / WRENCH
TECH NOTES	
<p>1. WIRE LENGTHS MEASURED FOR 3.5L CREW CAB SHORT BED.</p> <p>2. GOLD WIRE COLOR IN FIGURES DENOTES BASIC WIRE PATH (FOR CLARITY).</p> <p>3. SEE PAGE 6 FOR WIRE ROUTING DIAGRAM.</p>	
FUSE OPTIONS	
INJ	

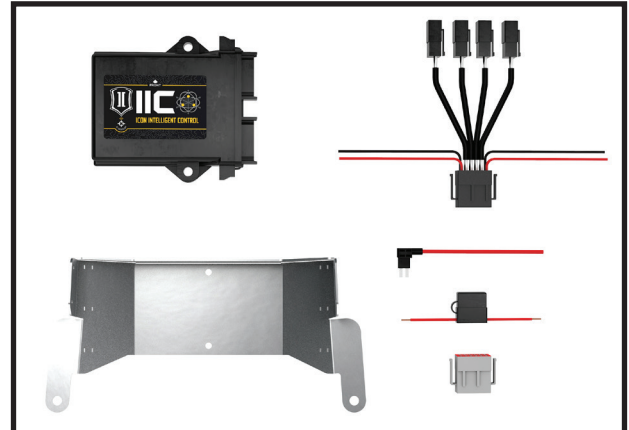

WARNING!

**** READ ALL INSTRUCTIONS THOROUGHLY FROM START TO FINISH BEFORE BEGINNING INSTALLATION! IF THESE INSTRUCTIONS ARE NOT PROPERLY FOLLOWED SEVERE FRAME, SUSPENSION AND TIRE DAMAGE MAY RESULT TO THE VEHICLE!**

**** ICON VEHICLE DYNAMICS RECOMMENDS THAT YOU EXERCISE EXTREME CAUTION WHEN WORKING UNDER A VEHICLE THAT IS SUPPORTED WITH JACK STANDS.**

**** ICON VEHICLE DYNAMICS RECOMMENDS ALL INSTALLATION TO BE PERFORMED BY A PROFESSIONAL SHOP/SERVICE TECHNICIAN. PRODUCT FAILURE CAUSED BY IMPROPER INSTALLATION WILL NOT BE COVERED UNDER ICON'S WARRANTY POLICY.**

INSTALLATION

1. Disconnect the battery using a 12mm.
2. Install the 2 adhesive strips on the mount as shown. [FIGURE 1]

FIG.1



3. Connect the IIC to the mounting plate using the supplied 1/4 bolts (PN: 605069). Be sure the wire plugs are on the passenger side of the truck. Torque to 50 in-lbs using a 7/16.
4. Remove the 2 grill support screws. Position the mount under the grill supports. Slide the bracket down lengthwise into the grill cavity. Once inside the grill, rotate the bracket up and into position. Make sure the mount is slid up firmly against the grill supports and mark the hole locations in the side of the grill supports.
5. Remove the mount and using the supplied self-drilling screws (PN 605033), drill and thread the holes using a Philips head screwdriver.
6. Install the mounting plate using the supplied screws in the sides of the grill supports. Use a Philips head screwdriver and do not overtighten. Secure the grill supports using the factory screws and torque to factory spec using a 10mm.

7. Fasten the mount to the sides of the grill supports using the supplied screw (PN: 60533). [FIGURE 2 & 3]

FIG.2



FIG.3

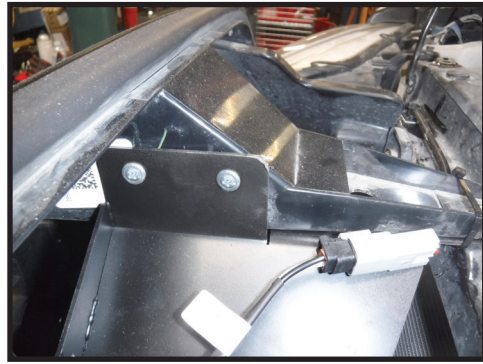

8. Connect the wire harness (PN: 255602) to the black plug on the IIC.

9. Connect the block off plug (PN: 255601) to the grey plug of the IIC. [FIGURE 4]

FIG.4



10. Use the supplied wire loom (PN: 605760) to hold the 2 black “Ground” wires and the Red “PWR/BATT” wire together. Slide the loom up close to the connector of the IIC. Route the loom between the fender and the fuse box. Trim as needed.

11. Connect the 6-FT wire to the Channel 3 pigtail. Run the wire over the passenger side fender.

12. Connect the 8-FT wire to the Channel 4 pigtail. Run the wire over the driver side fender.

13. Connect the 18-FT wire to the Channel 2 pigtail. Run the wire over the driver side fender.

14. Connect the 30-FT wire to the Channel 1 pigtail. Run the wire over the driver side fender.

15. Run the 6-FT wire under the passenger side grill support and through the window into the engine compartment. Route along the passenger side fender to the air cleaner. Route down into the passenger side fender well and connect to the passenger side CDE-Shock solenoid. Zip-tie any excess wire in the engine compartment in a safe/protected area [FIGURE 5 & 6]. Be sure to leave some slack in the wire to ensure there is freedom of movement and the ability to unplug the wire from the shock

FIG.5

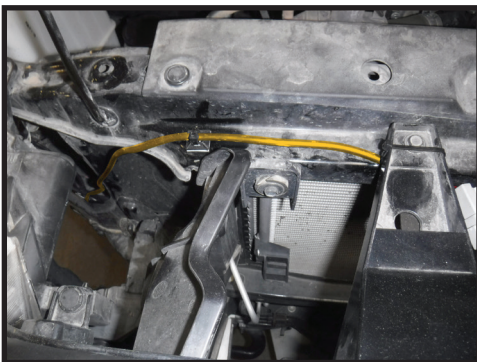

FIG.6



16. Install wire loom over 2 red & 2 black wires.

17. Zip-tie the 8-FT, 18-FT, and 30-FT wires together in 12 inch increments. Leave the last 36” of the 8-FT wire free. Continue zip-tying the 18-FT and 30-ft wire together in 12 inch increments. Leave the last 24” of the 18-FT wire free.

18. Fasten the bundle to the leading edge of the mounting bracket wrapping around to the driver side of the hood latch using zip-ties.

19. Run the wires under the driver side grill support. Run the wires down and through the window into the engine compartment. Zip-tie the wires to the factory wiring harness in front of the battery. Route the 8-FT wire to the driver front shock. Route it around the front of the battery and down into the wheel well. Plug into the driver front CDE-Shock solenoid and zip-tie the remaining wire up away from the exhaust. Be sure to leave some slack in the wire to ensure there is freedom of movement and the ability to unplug the wire from the shock. [FIGURE 7 & 8]

FIG.7



FIG.8

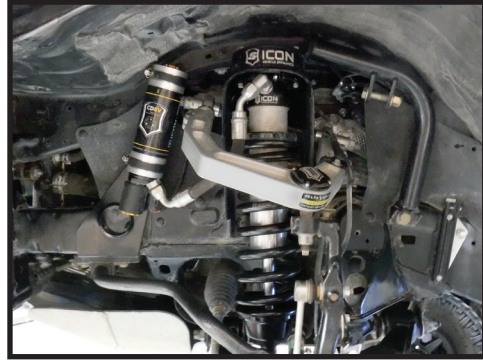

20. Continue routing the 18-FT wire and 30-FT wire along the side of the battery and fuse box. Rout the wires down along the back of the fender to the back of the wheel well under the brake master cylinder. Zip-tie along wire harness when possible. Be sure to keep wires as far from exhaust as possible. [FIGURE 9 & 10]

FIG.9



FIG.10



21. Pull the wires through into the back of the wheel well. Feed the wires back along the top of the driver side frame rail. Continue zip-tying as you go. [FIGURE 11 & 12]

FIG.11



FIG.12



22. Continue following the factory wiring harness toward the back of the truck. [FIGURE 13 & 14]

FIG.13



FIG.14



23. As you reach the soft brake lines that extend down to the rear differential, 18-FT wire will split off to go to the driver rear shock. Plug into the driver rear CDE-Shock solenoid and zip-tie the remaining wire. Be sure to leave some slack in the wire to ensure there is freedom of movement and the ability to unplug the wire from the shock. [FIGURE 15]

FIG.15



24. Continue running the 30-FT wire down to the back of the frame and along the cross member. Continue zip-tying to the factory wiring harness as you go. [FIGURE 16 & 17]

FIG.16

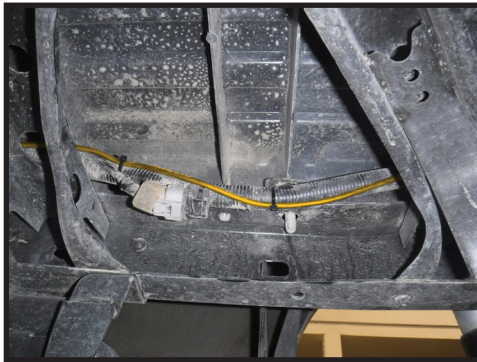
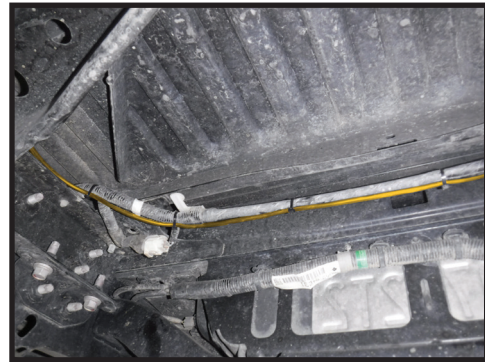

FIG.17



25. Once you reach the passenger side frame rail, route the wire along the top of the frame rail. Continue zip-tying to the factory wiring harness as you go. Plug into the passenger rear CDE-Shock solenoid and zip-tie the remaining wire. Be sure to leave some slack in the wire to ensure there is freedom of movement and the ability to unplug the wire from the shock. [FIGURE 18 & 19]

FIG.18

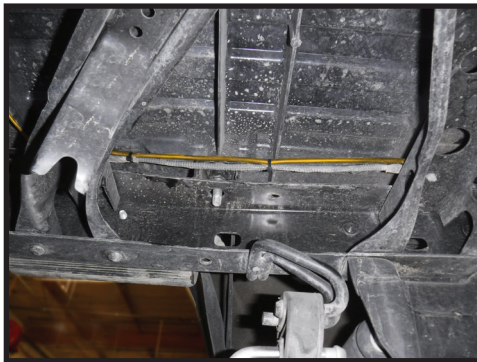

FIG.19



26. Route the “ground wires” to the battery negative terminal. With wires routed nicely, trim excess. Strip the end of the wires and crimp the supplied terminal connectors (PN: 605751) on. Use a heat gun to shrink the heat shrink.

27. Route the red wire labeled “PWR/BATTERY” to the battery positive terminal. With wire routed nicely, trim excess. Strip the end of the wire and crimp the supplied terminal connector (PN: 605751) on. Use a heat gun to shrink the heat shrink.

28. Remove the Fuse box cover and locate the INJ fuse using the fuse diagram on the back of the fuse box cover. [FIGURE 20]

FIG.20



29. Remove the INJ Fuse and place it in the lowest slot of the supplied fuse tap (PN: 255607). Insert the supplied 2 AMP fuse (PN: 605754) in the upper slot. [FIGURE 21 & 21B]

FIG.21

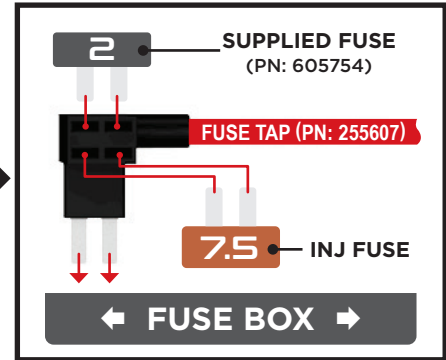
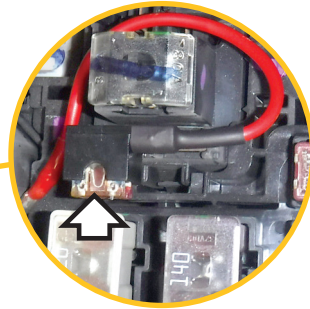
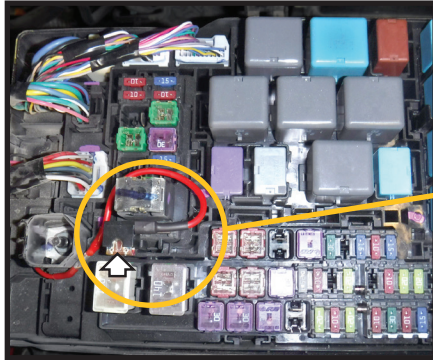
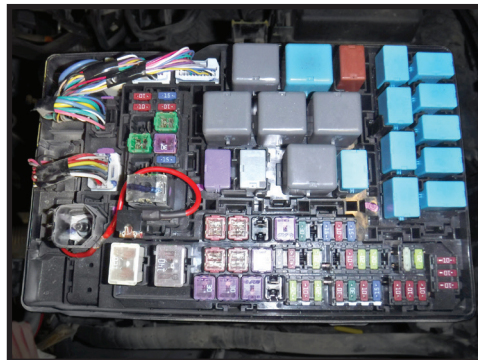

FIG.21B

30. Insert the fuse tap in the original location of the INJ fuse. [FIGURE 22]

FIG.22



31. Route the red wire labeled "ACC" to the fuse tap and trim excess. The best way to get inside the fuse box is through access holes through the bottom. There is a tight access hole next to one of the terminals. Use the supplied butt connector (PN: 605750) to connect the wire to the fuse tap. Use a heat gun to seal the crimp connection with heat shrink. [FIGURE 23]

FIG.23



32. Reconnect the battery using a 12mm.

33. Download the ICON INTELIGENT CONTROL App on you device. Open the app and turn on the vehicle.

**VERIFY ALL FASTENERS ARE PROPERLY TORQUED BEFORE DRIVING VEHICLE.
RETORQUE ALL NUTS, BOLTS AND LUGS AFTER 100 MILES AND PERIODICALLY THEREAFTER.**

WIRE ROUTING DIAGRAM: Tacoma

