

HOTCHKIS HOTCHKIS SPORT SUSPENSION

2268 FRONT AND REAR SPORT SWAY BAR SET 59-64 CHEVROLET B-BODY



- ✓ This installation will require drilling new mounting holes in the frame for both the front and rear sway bars. Please read instructions carefully to avoid unnecessary drilling.
- ✓ You will have to remove the pitman arm to install this sway bar!

INSTALLATION OF HOTCHKIS PERFORMANCE FRONT SWAY BAR

- 1) Securely block the rear wheels of the vehicle and raise the vehicle with a jack. Support the vehicle on jack stands. The wheels of the car should be turned straight for ease of installation. Some vehicles do not have a stock front sway bar, so step 2 can be ignored. This installation will also require a pitman arm puller. Use the photos below for reference.



The car shown above has power steering and a sway bar factory installed. Owners of cars without a factory sway bar should note the position of the brackets and end link mounts, as you will be adding all of these at a later time.

- 2) Unbolt the stock sway bar bushing brackets. Remove the bushings once the brackets are loose. Unbolt and remove the end links from each end of the bar. The bar should now be free moving and is held in the vehicle only by the steering assembly.

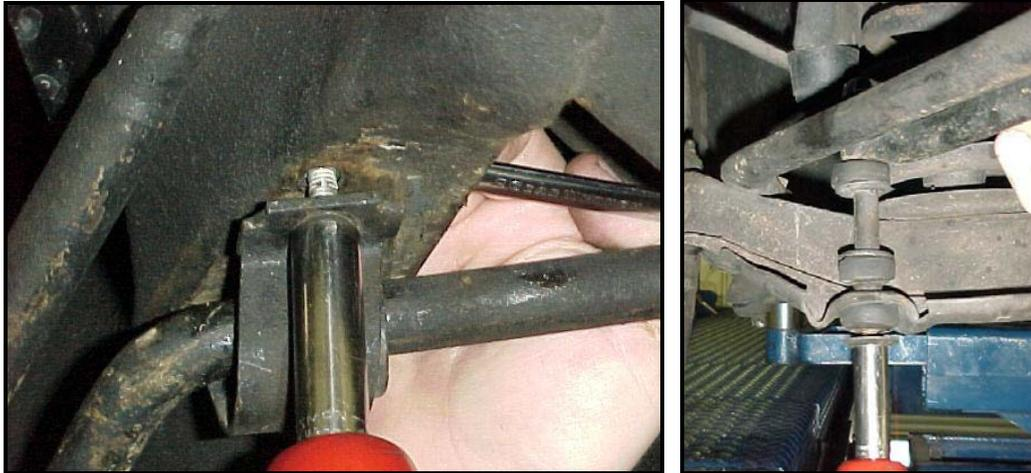

Cars with power steering will require that the power steering cylinder be unbolted from the bracket on the driver's side of the vehicle.

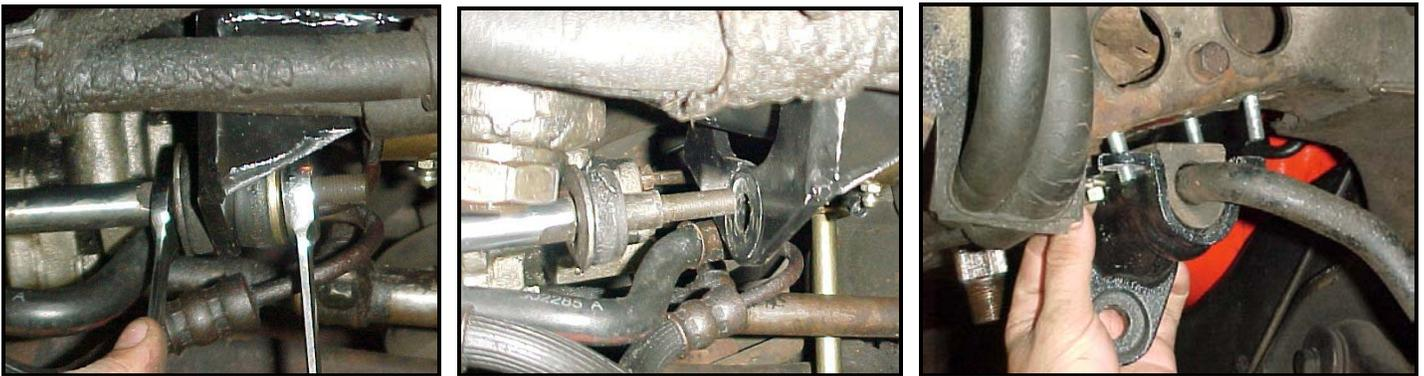

- 3) Remove the bolts holding the idler arm to the frame. Use a **1-5/16"** socket or wrench to remove the retaining nut attaching the pitman arm to the gearbox. Use the pitman arm puller to free the pitman arm from the gearbox.

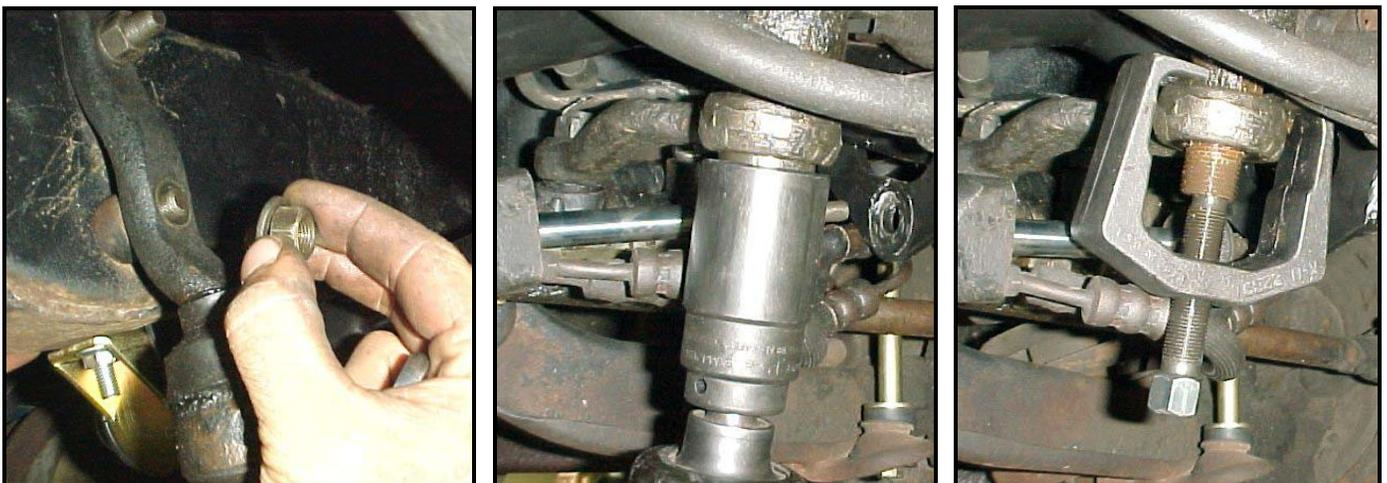

Note the position of the gearbox teeth and pitman arm to maintain proper steering when re-installing the pitman arm in a later step!

- 4) With the steering assembly hanging free, you should now be able to remove the stock sway bar.



Leave the steering loose for installation of the Hotchkis sway bar at a later step.

- 5) Every vehicle should have two holes on the passenger side and four holes on the driver's side in the frame from the factory for mounting a stock sway bar. Use the front factory holes to bolt the new sway bar retainer bracket in place. With the bracket bolted in to locate the second hole, drill out the second hole. Use the 3/8" bolts from **hardware kit #1735** to install the sway bar.

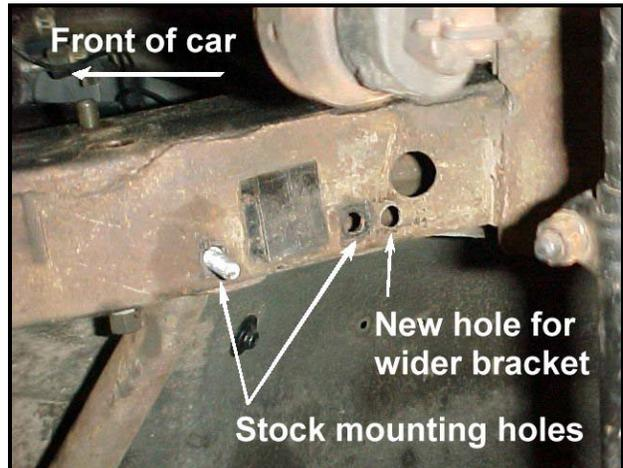
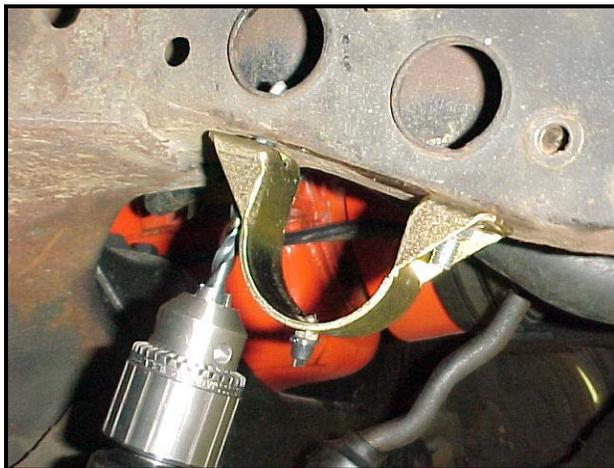

Use the power steering bracket included in the kit and installation pictures to determine which hole must be moved or what holes may need to be added on the driver's side.

- 6) Use the grease pack provided to put a heavy coat of grease on the inside of the sway bar bushings. Place one bushing over the passenger side of the sway bar and lift it into place on top of the steering rack. Use one of the bushing retainer brackets to keep the bar from falling out from the passenger side.



- 7) With the bar supported on the passenger side you can now slide the power steering bracket over the driver's side end of the bar. The bracket should slide over the bar and line up with the stock mounting holes and the welded stud in the frame.



Tighten the hardware on the inside edge of the bracket nearest to the hole that the bar passes through.

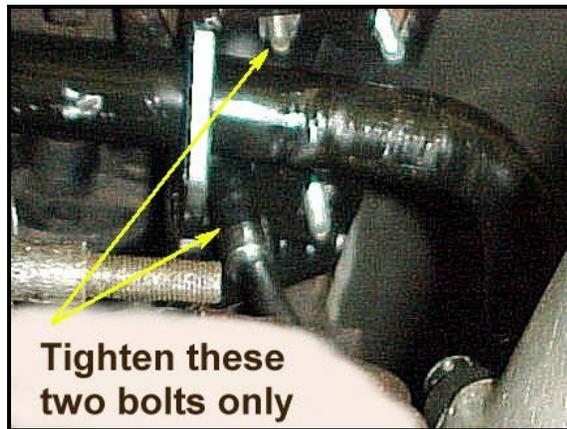
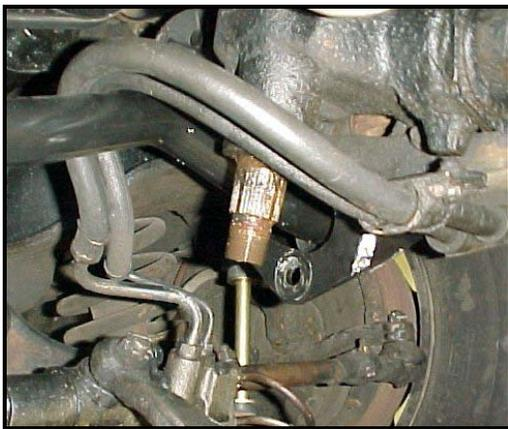

Route the power steering lines over the sway bar!

- 8) Take the second bushing (already greased in step 6) and place it over the driver's side with the sway bar retainer bracket. For cars without power steering (photo on the left) the bracket will mount to the holes in the same manner as the passenger side of the vehicle.



The driver's side bracket mounts inside of the power steering bracket included with the Hotchkis kit. Slide the retainer bracket into place over the bolts and tighten the bracket into place.

- 9) Install the new end links through the sway bar and the stock mounts on the lower a-arms. Tighten the end link and all sway bar bracket hardware into place.



For cars without a stock front bar, you will have to connect the end links to the sway bar. Attach the end link mount bracket included with the kit to the end links and tighten. Rotate the full assembly into position against the lower a-arm and drill the mounting holes in the arm. Use the 10mm bolts from **hardware kit #T1711** to secure the brackets.

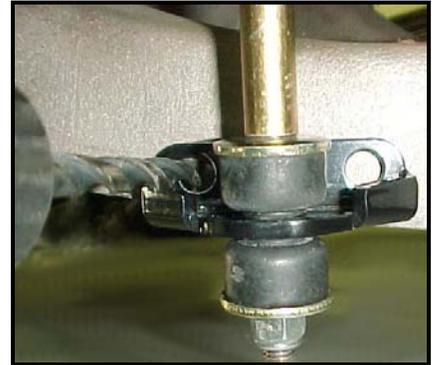

- 10) With all of the sway bar components in place and tightened down you can re-attach the steering. Push the pitman arm back onto the gearbox in the same position as it was removed. Don't worry if it doesn't slide all the way onto the gear, when you tighten the retaining nut it will move the arm up the shaft. Re-install the bolts holding the idler arm.



- 11) **Cars with power steering** should re-attach the power steering cylinder to the new bracket.

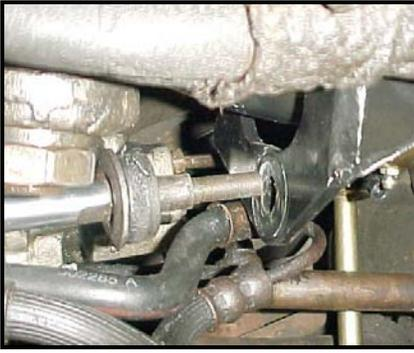

- 12) Check that all hardware is tight. Cover the grease fittings using the zerk caps provided. Remove the jack stands and move on to installing the rear sway bar!

IMPORTANT! For proper maintenance the bushings should be greased at least once a year (15,000 miles) or whenever excessive noise occurs. Use only non-lithium based grease. Lithium based grease can wash out with water.

HOTCHKIS SPORT SUSPENSION

INSTALLATION OF HOTCHKIS PERFORMANCE REAR SWAY BAR



Before you proceed, please see the **Special Notice** on page 11 regarding frame type.

- 1) Securely block the front wheels of the vehicle and jack up the rear end. Support the rear end on jack stands and place the jack under the rear end for later use. *You will have to have the rear axle at approximate normal ride height to install the rear sway bar in a later step.*
- 2) Begin by placing the u-bolts from **hardware kit #T1722** over the rear axle. Place them roughly the same distance from the center of the axle, with the ends of the u-bolts pointed straight down. See the picture below for approximate spacing of the u-bolts when installed.

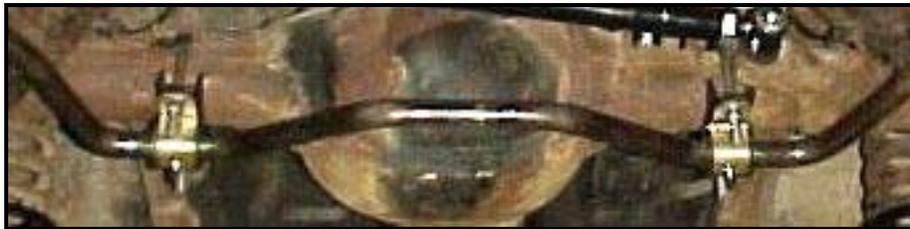
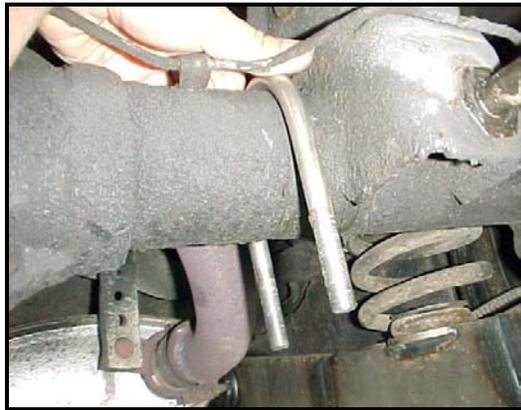

- 3) Use the grease pack provided to apply a heavy coat of grease to the inside of the sway bar bushings. Place the bushings over the bar. Push the brackets onto the sway bar bushings.



- 4) Use the grease provided to apply a heavy coat of grease to the sides of the bushings on the "dog bone" end links. Attach the mounting brackets to the end links using the shorter bolt from **hardware kit #T1712**. Attach the other end of the links to the sway bar using the longer bolt. Leave the attaching hardware loose. When attaching the hardware, **the large washer should be used to contact bushing surfaces and the small washer should be used to contact metal sway bar surface**. This prevents the bolt from pulling through the bushing.

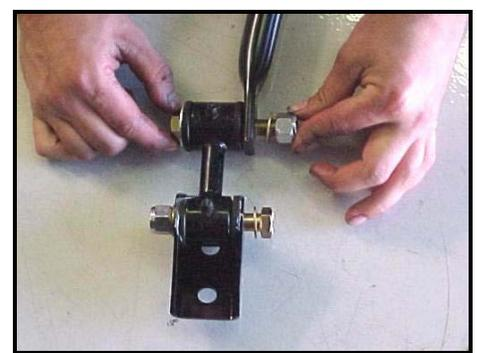
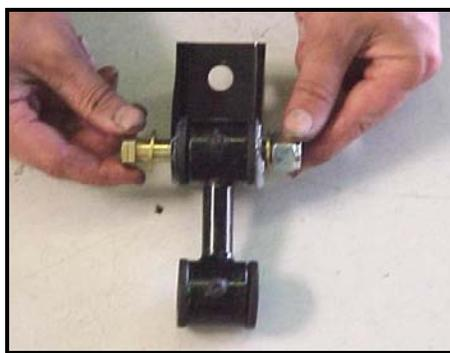

- 5) Hang the sway bar from the u-bolts on the axle. Slide the axle mount bracket over the ends of the u-bolts. Hold the sway bar up into place with the bushing retainer brackets mounted to the axle bracket.

Install with the nuts loosely started onto the u-bolts so that the sway bar hangs freely from the axle. **Use the anti-seize provided with the u-bolts to lubricate the threads.** *Failure to lubricate the threads can destroy the nylock nuts and possibly break the u-bolt or seize the nut in place when tightened.*



With the bar hanging freely you can slide the u-bolts along the axle until the bar is centered with the vehicle. Tighten down the nuts on the u-bolts to secure the position of the u-bolts and brackets.

- 6) Loosely tighten the hardware connecting the end links and brackets to the bar. *Leave just enough "slop" in the connections to allow the bar to rotate easily but still be fairly tight.*

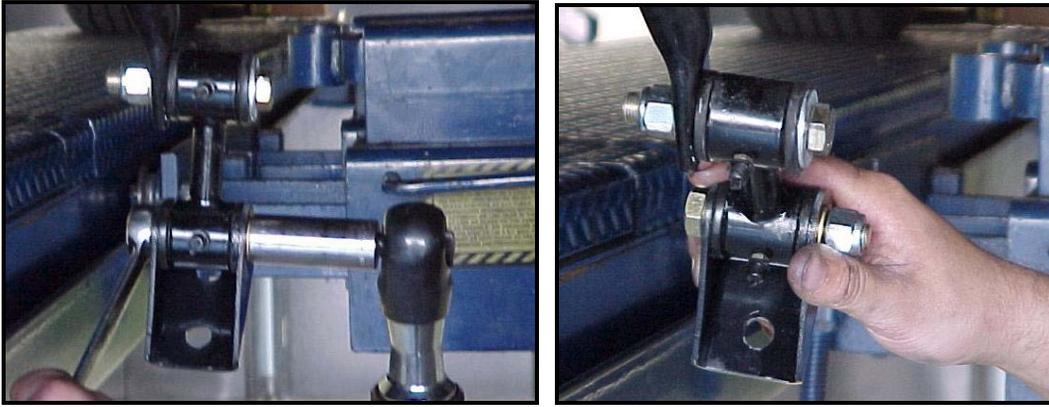

- 7) With the hardware loosely tightened you can now rotate the bar up, so that the brackets are resting against the frame. Once the brackets are in place use a scribe or similar tool to mark each hole for drilling. Drill out the holes for the brackets to 7/16" diameter. *To accurately determine the location of the holes the end links must not be loose enough to move left or right. **Make certain the axle is at its normal driving height for an accurate fit.***

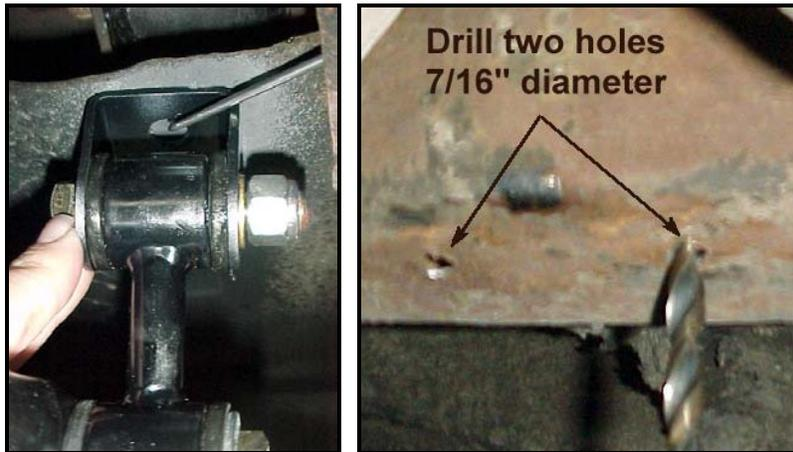

- 8) Once the holes are drilled, use a coat hanger to loop around one stud on the retainer bracket. Slide the bracket in through the rear end of the frame until the studs fall through the holes. Hold one stud and push the other stud back through the hole to slide the coat hanger loop off the stud.



- 9) Rotate the sway bar so that you can bolt the brackets up to the stud plate in the frame using the 7/16" hardware from kit #T1719. You will only be using four of the nuts and the four smaller washers on the studs. *The four additional nuts and washers are extra hardware not used on this kit and may be discarded.* Tighten the nuts on the brackets and the end link hardware. Torque the end link hardware to 30ft/lbs.



You can also adjust the stiffness of the bar by changing the hole the end link mounts to. The hole nearest to the end of the bar softens the bar stiffness by lengthening the bar. The hole furthest from the end of the bar stiffens the bar by shortening the length of the bar.

- 10) Check that all hardware is tight. Cover the grease fittings with the zerk caps provided. Remove the jack and jack stands and you're finished installing the sway bar set!

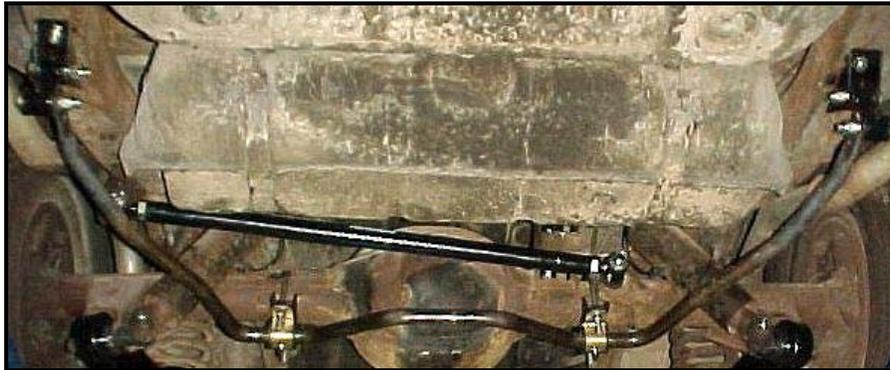

IMPORTANT NOTICE!!!

For some models, the vehicle may have a different rear section of the chassis frame. This alternate type of frame ends it's fully boxed tubing and transitions to a C-channel type. (See below) ↓



IF your vehicle has this type of frame, you must use **hardware kit # 1750** and proceed to the following special instructions.

Since the intersection between the box tubing and C-channel prevents you from using the retainer bracket, an alternative method will be used to mount the end link clevis brackets to the frame. We will use 2 bolts & washers to replace the retainer bracket.

INSTALLATION OF HOTCHKIS PERFORMANCE REAR SWAY BAR

- » Securely block the front wheels of the vehicle and jack up the rear end. Support the rear end on jack stands and place the jack under the rear end for later use. *You will have to have the rear axle at approximate normal ride height to install the rear sway bar in a later step.*
- » Begin by placing the u-bolts from **hardware kit #T1722** over the rear axle. Place them roughly the same distance from the center of the axle, with the ends of the u-bolts pointed straight down. See the picture below for approximate spacing of the u-bolts when installed.

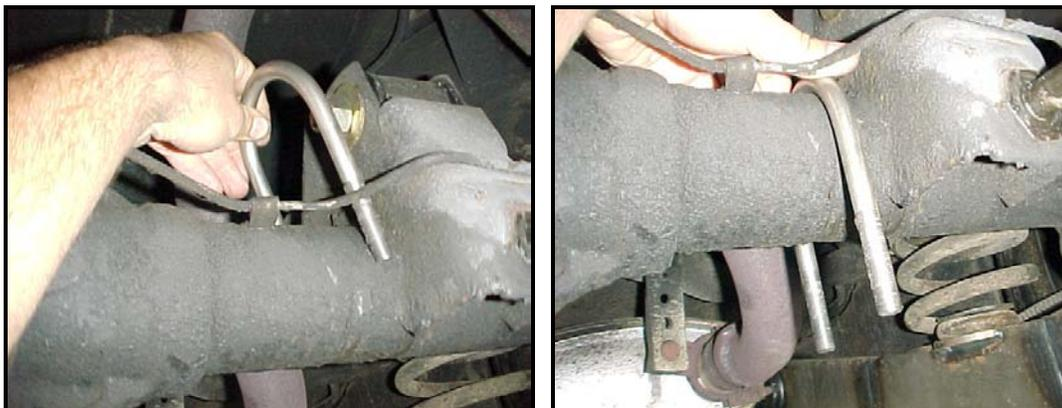



- » Use the grease pack provided to apply a heavy coat of grease to the inside of the sway bar bushings. Place the bushings over the bar. Push the brackets onto the sway bar bushings.



- » Hang the sway bar from the u-bolts on the axle. Slide the axle mount bracket over the ends of the u-bolts. Hold the sway bar up into place with the bushing retainer brackets mounted to the axle bracket.

Install with the nuts loosely started onto the u-bolts so that the sway bar hangs freely from the axle. **Use the anti-seize provided with the u-bolts to lubricate the threads.** *Failure to lubricate the threads can destroy the nylock nuts and possibly break the u-bolt or seize the nut in place when tightened.*

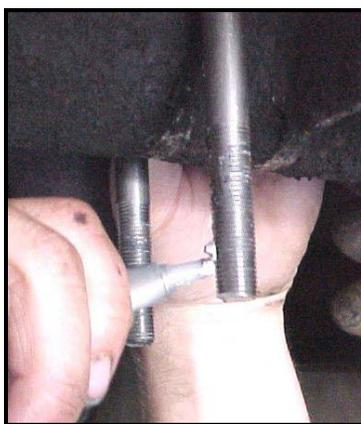

With the bar hanging freely you can slide the u-bolts along the axle until the bar is centered with the vehicle. Tighten down the nuts on the u-bolts to secure the position of the u-bolts and brackets.

- » Install the ½”-20 x 4” bolt through the sway bar hole and dogbone end link as shown in the picture. Lightly tighten hardware.

Hardware Order from Inboard to Outboard

1. Bolt (½”-20 x 4”)
2. Small Washer
3. Swaybar
4. 3 Spacers
5. Large Washer
6. Dogbone
7. Large Washer
8. Nylock Nut

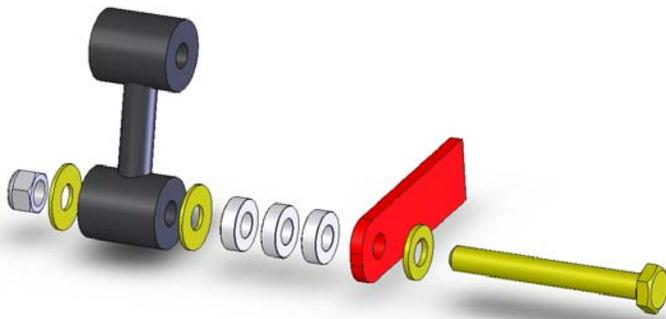

- » Install the Clevis Bracket onto the dogbone endlink. Lightly tighten.

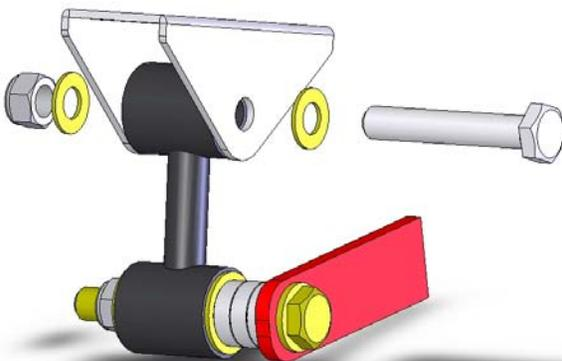

- » To accurately determine the location of the holes, the end links must NOT be loose enough to move left or right. Make certain the axle is at its normal driving height for an accurate fit. With the hardware lightly tightened, you can now rotate the bar up, so that the brackets are resting against the frame. Make sure both clevis brackets lay in the center of the frame. Position the clevis bracket onto the frame so that it will be possible to use either hole on the sway bar end.

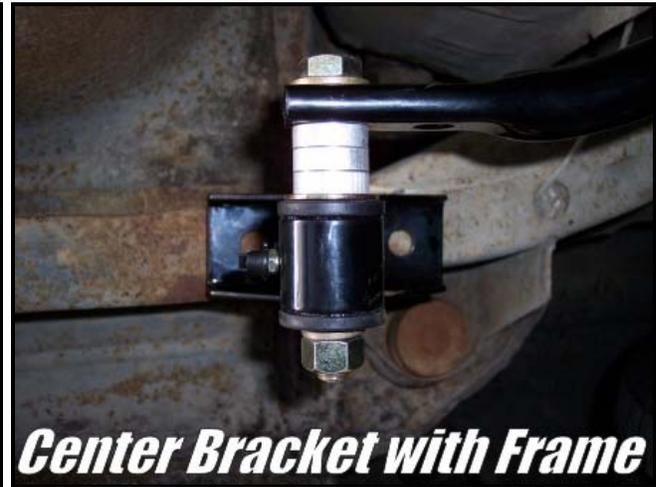
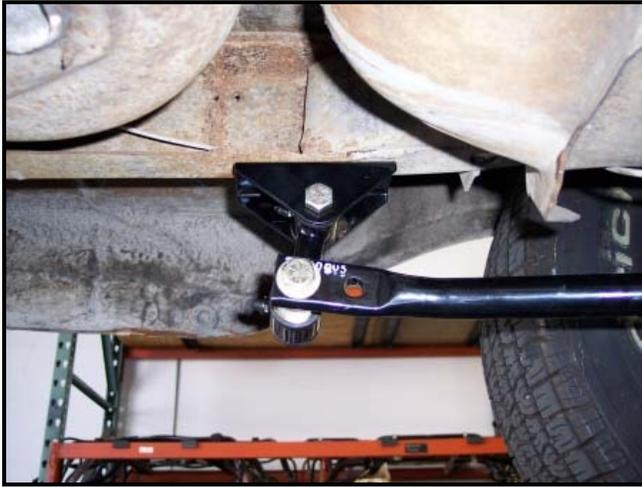

- » With a marker or scribe, mark the frame for the mounting holes. Drill out the holes to accept a 7/16" bolt. Do this for both sides.



- » Once the holes are drilled, grab a 7/16" x 1.25" bolt (longer) and a 7/16" washer. Using a telescoping magnet wand, fish the bolt and washer through the box tubing and set the bolt into it's drilled out hole.



- » Uninstall the clevis bracket & dogbone from the sway bar for now. It will be easier to install the bracket detached from the sway bar.
- » Here's a quick example of how the hardware should install. Fully tighten these bolts at this time. You may need to use one of the provided spacers to make up for the uneven surface of the frame. Your kit comes with 2 thin spacers and 2 thick spacers.

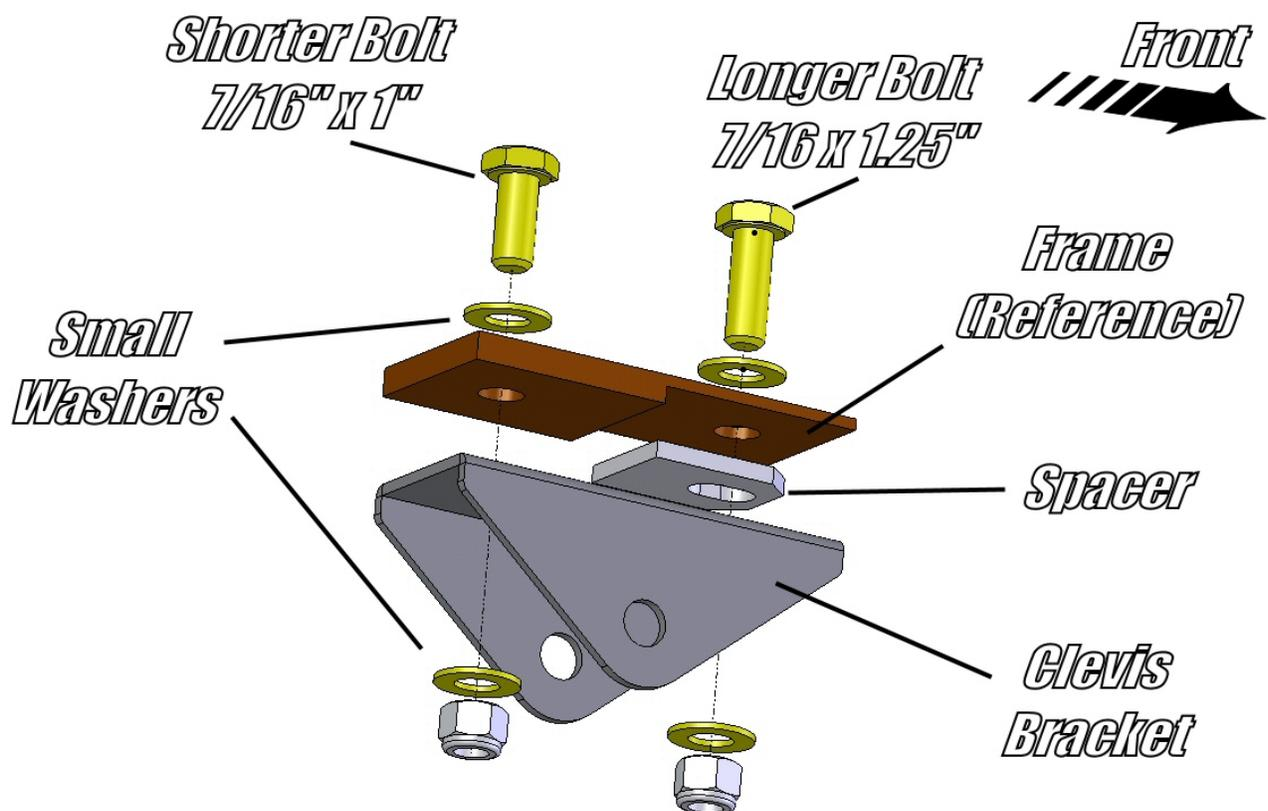

- » Once the clevis brackets are installed, loosen, but do not remove, the U-bolts holding the axle clamps. This eases swaybar centering and attaching the endlinks to the dogbones.
- » Attach the dogbones to the clevis bracket.



- » Attach the swaybar to the dogbones.



- » After all the hardware is loosely in place, fully tighten the hardware starting with the U-bolts. Make sure the U-bolts are facing straight down. Finish off the install by tightening the dogbone hardware. Your Done!!!



RE-CHECK ALL HARDWARE AFTER THE FIRST FIVE MILES!

IMPORTANT! For proper maintenance the bushings should be greased at least once a year (15,000 miles) or whenever excessive noise occurs. Use only non-lithium based grease. Lithium based grease can wash out with water.

SEE NEXT PAGE FOR PARTS LIST



**UNIVERSAL
AUTOMOTIVE
SPORT SUSPENSION**

59-64 Chevrolet B-body Sport Sway Bar Kit, Parts List

	Hotchkis P/N	Item Description	Quantity per kit
1	22810005	Front Sway Bar, 59-64 Chevrolet B-body	1
2	23090066	Sway Bar Bushing Retainer Bracket, Greaseable Heavy Duty	2
3	5637.01	1-1/4" Sway Bar Bushing, Greaseable Heavy Duty	2
4	23410005	Power Steering Bracket, 59-64 Chevrolet B-body	1
5	23810005	A-arm End Link Mount Bracket, 59-64 Chevrolet B-body	2
6	19-416-BL	Endlink Kit, 59-64 Chevrolet B-body (two end links & hardware)	1
7	T1722	3" U-bolts w/ hardware, kit (see <i>hardware kit listing on next page</i>)	1
8	23990117	Stud Plate, Welded	2
9	25210035	3" End Link Kit, Dog Bone Style (two end links per kit)	1
10	T2211	Axle Mount Bracket Kit, 59-64 Chevy B-body (two brackets per kit)	1
11	22910005	Rear Sway Bar, 59-64 Chevrolet B-body	1
12	15.12.06.39	Sway Bar Bushing Retainer Bracket, Greaseable Car Style	2
13	5340G	1" Sway Bar Bushing, Greaseable Car Style	2
14	T2221	Rear Frame Bracket Kit, 59-64 Chevy B-body (two brackets per kit)	1

Items Not Shown

15	9.11108	Grease Pack	2
16	n/a	Instruction Set	1



HARDWARE KITS LISTED ON NEXT PAGE

Hardware Kits For Sway Bar Kit 2268 (one of each kit listed)

Hotchkis P/N	Item Description	Quantity per kit
--------------	------------------	------------------

Hardware Included in Kit T1711

17	M10-1.5X25CS	10mm, Hex Head Bolt	4
18	M10SAEWASH	10mm Flat Washer	8
19	10NYLOCK	10mm Nylock Nut	4

Hardware Included in Kit T1712

20	12-20 X 3"	1/2" Bolt, 3" long	2
21	1/2-20X2.75"	1/2" Bolt, 2-3/4" long, Hex Head	2
22	7/16USS FW	7/16" Flat Washer	8
23	1/2AN	1/2" Flat Washer	4
24	1/2-20 NUT	1/2" Nylock Nut	4

Hardware Included in Kit 1719

25	7/16NYLOCK	7/16" Nylock Nut	8
26	7/16AN	7/16" Flat Washer	4
27	7/16 SAE FW	7/16" Rear Sway Bar Washer	4

Hardware Included in Kit T1722

-	T1722	3" U-bolt, Stainless Steel	2
-	7/16AN	7/16" Flat Washer	4
-	7/16NYLOCK	7/16" Nylock Nut	4
28	ND907	Anti-Sieze, 1/8oz. Tube	1

Hardware Included in Kit 1735

29	3/8-24X1.25	3/8" Bolt, 1.25" Long, Hex Head	8
30	3/8AN	3/8" Flat Washer	16
31	3/8NYLOCK	3/8" Nylock Nut	8

Hardware Included in Kit 1750 (Not Shown)

29	16400147	Aluminum Spacers 2pck.	3
30	1/2-20x4	1/2 - 20 x 4 G8 HBCS Bolt	2
31	7/16-20x11/4	7/16 - 20 x 1 1/4 G8 HBCS Bolt	2
32	7/16-20x1	7/16 - 20 x 1 G8 HBCS Bolt	2
33	7/16SAEWASH	7/16 SAE Washer G8	8
34	23410006	Spacer Plate, B Body - Thick	2
35	23410007	Spacer Plate, B Body - Thin	2



HOTCHKIS HOTCHKIS SPORT SUSPENSION

TMS

TOTAL VEHICLE SYSTEM

CHECK OUT EVERYTHING ELSE HOTCHKIS PERFORMANCE MAKES FOR YOUR 59-64
B-BODY CHEVROLET!!



Adjustable upper trailing arm, to help eliminate pinion angle vibrations!



Boxed lower trailing arms, to help stiffen up the rear end!



Double adjustable pan-hard rod to help center the axle!