

2020 HORNADY® PRODUCT CATALOG



ATITM
MATCH

Contents

AMMUNITION

Outfitter®	6
Precision Hunter®	8
Superformance®	10
Superformance® Varmint	12
Hornady BLACK®	14
Subsonic	16
LEVERevolution®	18
American Whitetail®	20
Custom Lite®	22
Varmint Express®	24
Match™	26

Dangerous Game™ Series	28
Custom™	30
American Gunner®	32
Frontier® Cartridge	34
Handgun Hunter™	36
Custom™ Pistol	38
Critical Duty®	40
Critical Defense®	42
Shotgun Slugs	44
Heavy Magnum® Shotgun	46
Muzzleloading	47

BULLETS

A-Tip™ Match	52
ELD-X®	54
ELD® Match	56
Match™	58
A-MAX®	59
Sub-X®	60
MonoFlex®	61
GMX®	62
InterBond®	64
SST®	65
FTX® Rifle	66

FTX® Handgun	67
V-MAX®	68
Traditional Varmint™/NTX®	69
DGX® Bonded	70
DGS®	71
InterLock®	72
Traditional & FMJ Rifle	75
FMJ Handgun	75
XTP®/XTP® Mag™	76
HAP®	78
Frontier® Lead	79

RELOADING

Lock-N-Load® Iron Press®	82
Lock-N-Load® Classic™	84
Lock-N-Load® Kits	85
Lock-N-Load® AP™	86
Lock-N-Load® Ammo Plant™	87
Lock-N-Load® AP™ Accessories	88
Powder Measures & Accessories	94
Scales & Accessories	96
Cartridge Cases	98
Case Tumblers & Accessories	100

Sonic Cleaners & Accessories	102
Reloading Accessories	104
Case Prep Tools	106
Reloading Manual & Ballistic Calculator	110
Lock-N-Load® Precision Gauges	112
Custom Grade™ Dies	114
Match Grade™ Dies	116
Custom Dies	118
Custom Bullet Seating Stems	119
Individual Dies & Accessories	120

HORNADY SECURITY®

Hornady Security® RAPiD® Safes	125
Keypad Vaults	131
Lock Boxes	132
Safe Accessories	133
Hornady® Hats	135

Hornady® Apparel	136
Shooter Accessories	137
Stickers & Shooter Accessories	141
Dies & Reloading Essentials	142
Ballistics	149

A message from Steve and Jason Hornady:

At Hornady®, we're always trying to go one better. How can we take a great product and make it even greater? How can we build on the innovations of the past to break new ground in the future?

Much of what you'll find in this year's catalog represents our never-ending quest to make things even more accurate, precise and secure than the year before.

Take our A-Tip™ Match bullets, for example. Their unparalleled accuracy and consistency have taken the competitive shooting world by storm, resulting in A-Tip™ shooters claiming six of the top 10 spots in the Precision Rifle Series.

Our rough and rugged Handgun Hunter™ cartridges feature an elastomer material in the bullet's open cavity that makes it expand faster than a standard hollow point.

The new Auto Charge® Pro Powder Measure and Precision Measurement Station allow reloaders to take their craft to ever greater levels of precision.

The RAPiD® Safe Ready Vault™ combines RFID technology with innovative adaptable storage, while the RAPiD® Safe Night Guard™ sets a new standard for discreet security.

At Hornady, we've always been about doing our best — and then going one better. The fruits of our labors are yours to enjoy.

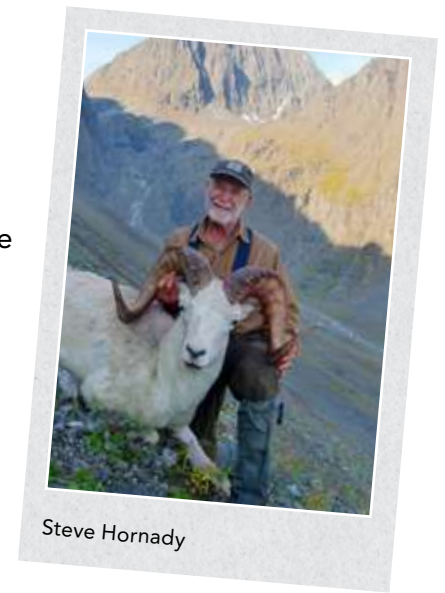

Steve Hornady



Jason Hornady with his kids, Alex and Abby

Steve Hornady
Steve Hornady

Jason Hornady
Jason Hornady

2020 New Product Highlights



A-Tip™ Match Bullets

- 22 Cal. 90 gr. A-Tip™ Match
- 6mm 110 gr. A-Tip™ Match
- 6.5mm 135 gr. A-Tip™ Match
- 6.5mm 153 gr. A-Tip™ Match
- 7mm 166 gr. A-Tip™ Match
- 7mm 190 gr. A-Tip™ Match
- 30 Cal. 176 gr. A-Tip™ Match
- 30 Cal. 230 gr. A-Tip™ Match
- 30 Cal. 250 gr. A-Tip™ Match
- 338 Cal. 300 gr. A-Tip™ Match
- 375 Cal. 390 gr. A-Tip™ Match
- 416 Cal. 500 gr. A-Tip™ Match



Subsonic Rifle & Handgun



Rifle

- 30-30 Win 175 gr. Sub-X®
- 450 Bushmaster 395 gr. Sub-X®
- 45-70 GOVT 410 gr. Sub-X®

Handgun

- 9mm Luger 147 gr. XTP®
- 40 S&W 180 gr. XTP®
- 45 Auto 230 gr. XTP®

Handgun Hunter™



- 9mm Luger +P 115 gr. MonoFlex®
- 357 Mag 130 gr. MonoFlex®
- 40 S&W 135 gr. MonoFlex®
- 10mm Auto 135 gr. MonoFlex®

- 44 Rem Mag 200 gr. MonoFlex®
- 454 Casull 200 gr. MonoFlex®
- 460 S&W 200 gr. MonoFlex®



2020 New Product Highlights

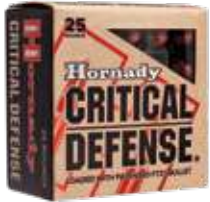

Critical Defense®

- 327 Federal Mag 80 gr. FTX®



Precision Hunter®

- 300 Win Mag 178 gr. ELD-X®



Outfitter®

- 257 Wby Mag 90 gr. GMX®
- 300 Wby Mag 180 gr. GMX®
- 300 Rem Ultra Mag 180 gr. GMX®
- 338 Win Mag 225 gr. GMX®



LEVERevolution®

- 7-30 Waters 120 gr. FTX®



American Whitetail®

- 350 Legend 170 gr. InterLock® SP
- 450 Bushmaster 245 gr. InterLock® SP



Custom™

- 350 Legend 165 gr. FTX®



American Gunner®

- 7.62x39 123 gr. HP Match™



Superformance®

- 6mm Creedmoor 90 gr. GMX®

New Bullet Line

Sub-X®

- 30 Cal. 190 gr. Sub-X®

Bullet Line Extensions

FTX®

- 7mm 120 gr. FTX®
- 35 Cal. (350 Legend) 165 gr. FTX®

GMX®

- 6mm (6mm Creedmoor) 90 gr. GMX®
- 6.5mm 140 gr. GMX®
- 338 Cal. 225 gr. GMX®

InterLock®

- 35 Cal. (350 Legend) 170 gr. InterLock®
- 45 Cal. 245 gr. InterLock®

NTX®

- 17 Cal. 15.5 gr. NTX®

V-MAX®

- 5.45 Cal. 60 gr. V-MAX®



Hornady® Cases

RIFLE CASES

- 5.45x39
- 7-30 Waters
- 284 Win
- 350 Legend

PISTOL CASES

- 32 H&R Mag
- 327 Federal Mag
- 41 Rem Mag

2020 New Product Highlights



L-N-L® Impact
Bullet Puller



Precision
Measurement
Station



Auto
Charge®
Pro



RAPID® SAFE
READY
VAULT™

RAPID® SAFE
NIGHT
GUARD™





AMMUNITION



Before it leaves the factory, Hornady® ammunition is designed, tested, and scrutinized to ensure it will perform flawlessly in every environment. It's an exhausting process born from an idea that every shooter should have the best chance for success. When you pick up a box of Hornady® ammunition, you are holding the best bullets, exceptional brass, and the brainchild of a company full of discerning designers, ballisticians, technicians, and press operators. When you submit notes and photos of your shooting experiences, it makes a direct, positive impact upon the people who make Hornady® products. So please keep them coming — we love it!





Outfitter®

From the backcountry to the back-forty, trust your hunt to Outfitter® ammunition. Featuring corrosion-resistant nickel-plated cases that are sealed watertight and topped with the accurate and rugged GMX® bullet, Outfitter® ammunition is designed to perform under the toughest conditions.

PROVEN GMX® BULLETS

Monolithic copper alloy GMX® bullet provides uniform, controlled expansion, deep penetration and +95% weight retention.

SEALED PRIMER AND CASE MOUTH

Sealed primer and case mouth provide watertight protection.

WATERPROOFED CASES

Nickel-plated cases are corrosion resistant and waterproofed to ensure protection from moisture.

VERSATILE PERFORMANCE

California compatible and appropriate for other areas requiring non-traditional bullets.



PATRICK HULBERT



VANESSA HARROP



OUTFITTER®				
CARTRIDGE		BULLET	ITEM	COUNT
243 Win		80 gr. GMX®	80457	20
257 Wby Mag	NEW	90 gr. GMX®	81362	20
6.5 Creedmoor		120 gr. GMX®	81487	20
270 Win		130 gr. GMX®	80529	20
270 WSM		130 gr. GMX®	80557	20
7mm Rem Mag		150 gr. GMX®	80611	20
7mm WSM		150 gr. GMX®	80551	20
308 Win		165 gr. GMX®	80986	20
30-06 Sprg		180 gr. GMX®	81164	20
300 WSM		180 gr. GMX®	82203	20
300 Win Mag		180 gr. GMX®	82197	20
300 Wby Mag	NEW	180 gr. GMX®	82212	20
300 Rem Ultra Mag	NEW	180 gr. GMX®	8208	20
338 Win Mag	NEW	225 gr. GMX®	82339	20
375 Ruger		250 gr. GMX®	82337	20
375 H&H Mag		250 gr. GMX®	82331	20

See pages 149-157 for ballistics information.

TYSON OLSEN



ALEXANDER BUSCH



Precision Hunter[®]

Accuracy and terminal performance are the cornerstones of Hornady Precision Hunter[®] factory loaded ammunition. Great care has been given by Hornady[®] engineers to develop superior, match-accurate hunting loads that allow the ELD-X[®] bullet to achieve its maximum ballistic potential. Propellants used in the Precision Hunter[®] ammunition line are clean burning and loaded to uniform capacity for consistent shot-to-shot results regardless of temperature. This attention to detail provides the highest levels of accuracy and performance uniformity for the most demanding and diverse hunting situations.

Featuring the radically superior ELD-X[®] bullet with Heat Shield[®] tip, Precision Hunter[®] is the ideal load for ANY hunting situation because of its effective terminal performance at ALL practical ranges.

Featuring ELD-X[®] Bullets with Heat Shield[®] tip

BEST-IN-CLASS BCs

Verified by Doppler radar, the Heat Shield[®] tip defies the effects of aerodynamic heating and retains its shape to maintain the highest in-class BC over its entire trajectory.

MATCH ACCURATE HUNTING BULLET

Streamlined secant ogive with optimum boattail design + highly concentric AMP[®] bullet jackets + Heat Shield[®] tip combine for radically superior aerodynamic efficiency.

DEVASTATING CONVENTIONAL RANGE PERFORMANCE

With high velocity, 0-400 yard impact, the bullet continually expands throughout its penetration path. The thick shank of the jacket and high InterLock[®] ring work to keep the core and jacket together providing 50-60% weight retention.

BEST EXTENDED RANGE TERMINAL PERFORMANCE AVAILABLE

Upon low velocity, 400+ yard impacts, the Heat Shield[®] tip drives backward into the bullet to initiate expansion. Exhibiting controlled expansion with a large mushroom and 85-90% retained weight, the bullet provides deep penetration and large cavities.



See page 54 for more information on the ELD-X[®] bullet.



- Doppler radar-verified best-in-class BCs
- Match accurate hunting bullet
- Reliably expands at close and extended ranges
- Best extended range terminal performance available

FREE DOWNLOAD
Hornady Ballistic App with 4DOF[®]





Photo Credit: Kristy Titus



CRAIG BODDINGTON

PRECISION HUNTER®

CARTRIDGE	BULLET	ITEM	COUNT
243 Win	90 gr. ELD-X®	80462	20
6mm Creedmoor	103 gr. ELD-X®	81392	20
25-06 Rem	110 gr. ELD-X®	8143	20
257 Wby Mag	110 gr. ELD-X®	81364	20
6.5 Creedmoor	143 gr. ELD-X®	81499	20
6.5 PRC	143 gr. ELD-X®	81621	20
270 Win	145 gr. ELD-X®	80536	20
270 WSM	145 gr. ELD-X®	80558	20
7mm-08 Rem	150 gr. ELD-X®	85578	20
280 Rem	150 gr. ELD-X®	81587	20
280 Ackley Improved	162 gr. ELD-X®	85586	20
7mm Rem Mag	162 gr. ELD-X®	80636	20
7mm WSM	162 gr. ELD-X®	80552	20
28 Nosler	162 gr. ELD-X®	8069	20
7mm STW	162 gr. ELD-X®	80851	20

PRECISION HUNTER®

CARTRIDGE	BULLET	ITEM	COUNT
308 Win	178 gr. ELD-X®	80994	20
30-06 Sprg	178 gr. ELD-X®	81174	20
300 Rem SA Ultra Mag	178 gr. ELD-X®	82144	20
300 RCM	178 gr. ELD-X®	82224	20
300 WSM	200 gr. ELD-X®	82208	20
300 Win Mag	NEW 178 gr. ELD-X®	82041	20
300 Win Mag	200 gr. ELD-X®	82002	20
300 Wby Mag	200 gr. ELD-X®	82213	20
300 PRC	212 gr. ELD-X®	82166	20
300 Rem Ultra Mag	220 gr. ELD-X®	8209	20
30-378 Wby Mag	220 gr. ELD-X®	82214	20
338 Win Mag	230 gr. ELD-X®	82222	20
338 Lapua Mag	270 gr. ELD-X®	82313	20

See pages 149-157 for ballistics information.



Superformance[®]

Increase your rifle's performance up to 200 fps without extra chamber pressure, recoil, muzzle blast, temperature sensitivity, fouling, or loss of accuracy. Superformance[®] uses progressive propellants that take your favorite SST[®], GMX[®], and InterLock[®] bullets to levels of performance that are simply unattainable with conventional ammunition.

PROVEN HORNADY[®] BULLETS

Superformance[®] ammunition is loaded with Hornady[®] SST[®], GMX[®], and InterLock[®] bullets for the ultimate in performance, no matter what the game.

PROGRESSIVE HORNADY[®] POWDERS

Superformance[®] Propellants are the heart of Superformance[®] ammunition and usher in a new era of performance.

CASE AND PRIMER

Like all Hornady[®] ammunition, our Superformance[®] rounds use the highest quality cases and primers available. Consistent components translate to consistent shooting in the field.



KEVIN HOLMES



BJ & KATIE GLOVER

*It IS...
rocket science![®]*



IT IS FAST: 100 to 200 fps faster than conventional ammunition.

IT IS ACCURATE: Uncompromising accuracy without increased felt recoil.

IT IS CONSISTENT: Unfailing performance across a broad range of temperatures.

IT IS VERSATILE: This new breed of ammunition is available in 17 Hornet to 444 Marlin, and is safe for use in all firearm types including semi-autos,* lever guns and pump actions.

*May not work in some gas or semi-auto systems.

InterLock[®]



GMX[®]



SST[®]





SUPERFORMANCE®

CARTRIDGE	BULLET	ITEM	COUNT
223 Rem	55 gr. GMX®	83274	20
5.56 NATO	55 gr. GMX®	81254	20
243 Win	95 gr. SST®	80463	20
6mm Rem	95 gr. SST®	81663	20
6mm Creedmoor NEW	90 gr. GMX®	81394	20
257 Roberts	117 gr. SST®	81353	20
25-06 Rem	90 gr. GMX®	81446	20
25-06 Rem	117 gr. SST®	81453	20
6.5X55	140 gr. SST®	85507	20
260 Rem	129 gr. SST®	8552	20
6.5 Creedmoor	120 gr. GMX®	81490	20
6.5 Creedmoor	129 gr. SST®	81496	20
270 Win	130 gr. SST®	80543	20

SUPERFORMANCE®

CARTRIDGE	BULLET	ITEM	COUNT
270 Win	130 gr. GMX®	8052	20
270 Win	140 gr. SST®	80563	20
7mm-08 Rem	139 gr. SST®	80573	20
7mm-08 Rem	139 gr. GMX®	80576	20
7mm Rem Mag	139 gr. SST®	80593	20
7mm Rem Mag	154 gr. SST®	8061	20
7mm Rem Mag	162 gr. SST®	80633	20
300 Savage	150 gr. SST®	82221	20
308 Win	150 gr. SST®	80933	20
308 Win	165 gr. SST®	80983	20
308 Win	165 gr. GMX®	8099	20
30 TC	150 gr. SST®	81004	20
30-06 Sprg	150 gr. SST®	81093	20

SUPERFORMANCE®

CARTRIDGE	BULLET	ITEM	COUNT
30-06 Sprg	165 gr. SST®	81153	20
30-06 Sprg	165 gr. GMX®	8116	20
30-06 Sprg	180 gr. SST®	81183	20
300 RCM	150 gr. SST®	82231	20
300 Win Mag	165 gr. GMX®	82026	20
300 Win Mag	180 gr. SST®	82193	20
338 RCM	225 gr. SST®	82236	20
338 Win Mag	200 gr. SST®	82223	20
338 Win Mag	225 gr. SST®	82233	20
35 Whelen	200 gr. InterLock® SP	81193	20
444 Marlin	265 gr. InterLock® FP	82453	20

See pages 149-157 for ballistics information.



Superformance® Varmint

Superformance® Varmint ammunition delivers muzzle velocity increases of 100 to 200 feet per second from EVERY gun. Accuracy, increased range, flatter trajectory, less wind drift and devastating terminal results are all realized with Superformance® Varmint ammunition.

FAST

Superformance® Varmint is 100 to 200 fps FASTER than ANY conventional ammunition.

ACCURATE

Achieve superior accuracy, increased range, flatter trajectory, less wind drift.

DEADLY

Polymer tipped Hornady V-MAX® or NTX® bullets deliver match accuracy and rapid fragmentation.

VERSATILE

Optimal results are achieved in ALL firearms, including semi-autos.



Speed Kills!



GEOFF NEMNICH



SIERRA LANGBELL



TRENT AND FRED EICHLER SR.



SUPERFORMANCE® VARMINT

CARTRIDGE	BULLET	ITEM	COUNT
17 Hornet	20 gr. V-MAX®	83005	25
204 Ruger	24 gr. NTX®	83209	20
204 Ruger	32 gr. V-MAX®	83204	20
204 Ruger	40 gr. V-MAX®	83206	20
222 Rem	35gr. NTX®	8309	20
222 Rem	50 gr. V-MAX®	8316	20
223 Rem	35 gr. NTX®	83266	20
223 Rem	53 gr. V-MAX®	8025	20
22-250 Rem	35 gr. NTX®	8334	20
22-250 Rem	50 gr. V-MAX®	83366	20
243 Win	58 gr. V-MAX®	8343	20
243 Win	75 gr. V-MAX®	83433	20

See pages 149-157 for ballistics information.

SUPERFORMANCE® SHOTGUN

CARTRIDGE	BULLET/SHOT	ITEM	COUNT
12 GA Slug 2¾"	300 gr. MonoFlex®	86236	5

See pages 149-157 for ballistics information.



Hornady BLACK®

Hornady BLACK® ammunition features versatile loads optimized for excellent performance from America's favorite guns. Loaded with legendary Hornady® bullets, Hornady BLACK® ammunition is designed to fit, feed and function in a variety of platforms. Direct impingement, gas piston, suppressed, unsuppressed, inertia, bolt, pump, supersonic, subsonic, rifle, mid-length, carbine or pistol – Hornady BLACK® ammunition delivers superior performance for a variety of applications. Made in the USA.

VERSATILE HORNADY® BULLET OPTIONS

Depending on the caliber and its application, the best bullet options are chosen for each round and deliver the type of accuracy and performance you expect from Hornady®.

HIGH QUALITY CASES AND PRIMERS

Using only the highest quality cases and primers available, shooters will find that consistent components translate to consistent shooting in the field.

OPTIMIZED PERFORMANCE FROM VARIOUS PLATFORMS

Hornady BLACK® ammunition includes a variety of loads. Suppressed, unsuppressed, rifle, mid-length, carbine, pistol, subsonic; Hornady BLACK® has an optimized offering that will deliver excellent fit, feed and function in your favorite platform.



AMERICA'S GUN RUNS ON BLACK™



V-Max®



FTX



InterLock®



BTHP



SST®



A-MAX.



**ELD
MATCH**



FMJ





HORNADY BLACK®

CARTRIDGE		BULLET	ITEM	COUNT
5.45x39	NEW	60 gr. V-MAX®	81247	20
223 Rem		62 gr. FMJ	80234	20
223 Rem		75 gr. BTHP	80267	20
5.56 NATO		62 gr. FMJ	81263	20
5.56 NATO		75 gr. InterLock® HD SBR™	81296	20
224 Valkyrie		75 gr. BTHP	81532	20
6mm Creedmoor		105 gr. BTHP	81396	20
6.5 Grendel		123 gr. ELD® Match	81528	20
6.8mm SPC		110 gr. V-MAX®	83464	20
300 Blackout		110 gr. V-MAX®	80873	20
300 Blackout Subsonic		208 gr. A-MAX®	80891	20
308 Win		155 gr. A-MAX®	80927	20
308 Win		168 gr. A-MAX®	80971	20
7.62x39		123 gr. SST®	80784	20
450 Bushmaster		250 gr. FTX®	82246	20
12 GA		00 Buckshot	86249	10

See pages 149-157 for ballistics information.

KYLE LYNCH

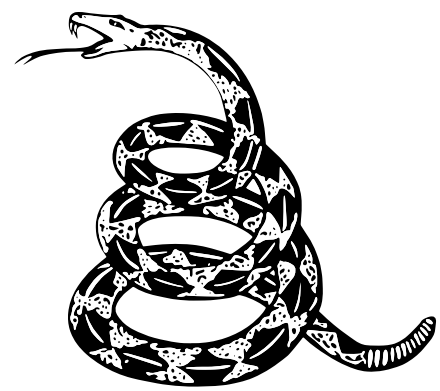

DONT TREAD ON ME



Subsonic

Hornady® has made a revolutionary breakthrough — without breaking the sound barrier. Hornady® Subsonic Ammunition represents the first truly reliable expanding subsonic round. Other subsonic rounds may expand, but petals shear off, causing the bullet to veer off course.

Here's how Hornady® engineers solved that problem. The hollow-point cavity of the Sub-X® (Subsonic — eXpanding) bullet features the patented Flex Tip® insert, which helps the bullet expand at low velocities.

That results in deep penetration and large wound channels with no loss of accuracy, proving that you don't have to be fast and loud to make a big impact.

SUB-X® BULLET TECHNOLOGY

In addition to its patented Flex Tip®, long grooves in the gilding metal jacket of the Sub-X® combine with the bullet's flat profile to ensure expansion. The Sub-X® features a lead core and a cannelure for a positive case crimp for use in semi-automatics or tubular magazines.

PROVEN PERFORMANCE

Performance of 300 Blackout Subsonic meets or exceeds FBI Protocol terminal ballistic test requirements. Impact velocity of 1,020 fps into ballistic gelatin provides 16-18" penetration and 90%+ weight retention.

SILENT AND STEALTHY

Hornady® Subsonic Ammunition doesn't have the loud report of a supersonic round, and paired with a suppressor, it's even quieter. Unique powders optimized for subsonic use result in a low flash signature, ideal for suppressed or un-suppressed performance.

SUB-X® BULLETS



*Shhh...
tell everyone!*



30-30 WIN 175 GR. SUB-X®



SUBSONIC HANDGUN

CARTRIDGE	BULLET	ITEM	COUNT
9mm Luger	NEW 147 gr. XTP®	90287	25
40 S&W	NEW 180 gr. XTP®	91369	20
45 Auto	NEW 230 gr. XTP®	90971	20

See pages 149-157 for ballistics information.

SUBSONIC RIFLE

CARTRIDGE	BULLET	ITEM	COUNT
300 Blackout	190 gr. Sub-X®	80877	20
30-30 Win	NEW 175 gr. Sub-X®	80809	20
450 Bushmaster	NEW 395 gr. Sub-X®	82247	20
45-70 GOVT	NEW 410 gr. Sub-X®	82742	20

See pages 149-157 for ballistics information.



450 BUSHMASTER 395 GR. SUB-X®

45-70 GOVT 410 GR. SUB-X®

Disclaimer: This is subsonic, i.e., reduced velocity ammunition and will not produce the same muzzle energy as conventionally loaded cartridges. If hunting with this product, be sure to read, understand and comply with all applicable regulations and laws pertaining to bullet energy and/or muzzle velocity for the area and game to be hunted.



LEVERevolution®

LEVERevolution® represents a breakthrough in ammo design for lever action rifles and revolvers. The key to its innovation and performance is the patented elastomer Flex Tip® technology of the FTX® and MonoFlex® bullets. Safe to use in tubular magazines, these bullets feature higher ballistic coefficients and deliver dramatically flatter trajectory for increased down range performance.

FLEX TIP® TECHNOLOGY

The patented Flex Tip® technology of the FTX® and MonoFlex® bullets provide higher ballistic coefficients and velocity increases of up to 250 fps over traditional flat point loads while still providing shock-absorbing safety in tubular magazines.

MODERN PROPELLANTS

New propellants provide maximum muzzle velocity at conventional pressures, resulting in flatter trajectories and more downrange energy.

OVERWHELMING PERFORMANCE

LEVERevolution® ammunition outperforms conventional loads for high weight retention, delivering up to 40% more energy than traditional flat point bullets. The higher ballistic coefficients of the FTX® and MonoFlex® bullets produce consistently flatter trajectories than conventional bullets and provide overwhelming downrange terminal performance.

*Flex Tip® technology for
lever guns and revolvers.*



U.S. Pat. No.
8,413,587 & 7,380,502



308 Marlin 160 gr. FTX®



444 Marlin 265 gr. FTX®



WAYNE VAN ZWOLL

Hornady's LEVERevolution load for the 307 Winchester, with 160-grain FTX bullets, delivered this 100-yard group for Wayne van Zwoll and a Model 94 Winchester.

- Up to 250 feet per second faster muzzle velocity than conventional lever gun loads.
- Exceptional accuracy and overwhelming downrange terminal performance.
- Patented FTX® and MonoFlex® bullets, featuring Flex Tip® Technology.
- Up to 40% more energy than traditional flat point loads.



MONOFLEX®

Combining the technologies of the GMX® and patented FTX® bullet design, the MonoFlex® bullet is a union of successful bullet designs from Hornady®. An innovative bullet choice is now available for the famed Hornady® LEVERevolution® ammunition line. Constructed of a copper alloy, MonoFlex® bullets will never separate, and when recovered, retain 95+% of their original weight. Deep penetration. High weight retention. Unbeatable power.



30 cal 140 gr.
2483 fps
Retained 136.9 gr.



In handguns, hollow point bullets typically deliver good performance at modest velocities, but expand too quickly and sacrifice penetration at higher velocities. Hornady® Flex Tip® technology allows the bullet to expand reliably from 800 to 2000+ fps.

LEVEREVOLUTION®

CARTRIDGE	BULLET	ITEM	COUNT
357 Magnum	140 gr. FTX®	92755	25
41 Rem Mag	190 gr. FTX®	9078	20
44 Rem Mag	225 gr. FTX®	92782	20
45 Colt	225 gr. FTX®	92792	20
25-35 Win	110 gr. FTX®	8277	20
7-30 Waters	NEW 120 gr. FTX®	81569	20
30-30 Win	140 gr. MonoFlex®	82731	20
30-30 Win	160 gr. FTX®	82730	20
307 Win	160 gr. FTX®	8273	20
308 Marlin Exp	160 gr. FTX®	82733	20
32 Win Spl	165 gr. FTX®	82732	20
338 Marlin Exp	200 gr. FTX®	82240	20
348 Win	200 gr. FTX®	82738	20
35 Rem	200 gr. FTX®	82735	20
444 Marlin	265 gr. FTX®	82744	20
45-70 Govt*	250 gr. MonoFlex®	82741	20
45-70 Govt*	325 gr. FTX®	82747	20
450 Marlin	325 gr. FTX®	82750	20

*Not for use in revolvers.

See pages 149-157 for ballistics information.

NOTE: The innovative LEVERevolution® FTX® and MonoFlex® bullet designs may require a newer magazine follower to provide best possible functioning of the last round out of the magazine in certain guns.



American Whitetail®

Opening day of deer season comes only once a year. Make sure you're ready when the big one steps out and load-up with Hornady® American Whitetail® ammunition.

Loaded with our legendary Hornady® InterLock® bullets in weights that have been deer hunting favorites for decades, American Whitetail® ammunition combines generations of ballistics know-how with modern components and the technology you need to take the buck of a lifetime!

Hornady® American Whitetail® ammunition — proudly made in the USA!

INTERLOCK® BULLETS

InterLock® bullets feature exposed lead tips for controlled expansion and hard-hitting terminal performance. Bullets used in American Whitetail® ammunition feature our pioneering secant ogive design and exclusive InterLock® ring — a raised ring inside the jacket that is embedded in the bullet's core that keeps the core and jacket locked together during expansion to retain mass and energy.

POWDERS

Loaded to conventional velocities, powder is matched to each load for optimum pressure and consistency, ensuring each load is compatible with semi-autos as well.

CASE AND PRIMER

Like all Hornady® ammunition, our American Whitetail® rounds use the highest quality cases and primers available. Consistent components translate to consistent shooting in the field.



InterLock®



*Make it a knock-down,
drag out hunt.®*

SABOTED INTERLOCK® SLUG FOR RIFLED BARRELS

InterLock® bullet with hollow point, serrated design and tough lead alloy core delivers maximum expansion and high weight retention.



1 OZ. RIFLED SLUG FOR SMOOTH BORE BARRELS

Optimized for performance in smooth bore shotguns, the lead alloy projectile expands to rapidly transfer energy upon impact.





AMERICAN WHITETAIL®

CARTRIDGE	BULLET	ITEM	COUNT
243 Win	100 gr. InterLock®	8047	20
25-06 Rem	117 gr. InterLock®	8144	20
6.5 Creedmoor	129 gr. InterLock®	81489	20
270 Win	130 gr. InterLock®	8053	20
270 Win	140 gr. InterLock®	80534	20
7mm-08 Rem	139 gr. InterLock®	8057	20
7mm Rem Mag	139 gr. InterLock®	80591	20
7mm Rem Mag	154 gr. InterLock®	80590	20
30-30 Win	150 gr. InterLock® RN	80801	20
308 Win	150 gr. InterLock®	8090	20
308 Win	165 gr. InterLock®	80904	20
30-06 Sprg	150 gr. InterLock®	8108	20
30-06 Sprg	180 gr. InterLock®	81084	20
300 WSM	165 gr. InterLock®	82204	20
300 Win Mag	150 gr. InterLock®	8204	20
300 Win Mag	180 gr. InterLock®	82044	20
350 Legend	NEW 170 gr. InterLock®	81196	20
450 Bushmaster	NEW 245 gr. InterLock®	82242	20

See pages 149-157 for ballistics information.

AMERICAN WHITETAIL® SLUGS

CARTRIDGE	BULLET	ITEM	COUNT
12 GA Slug	325 gr. InterLock®	86271	5
12 GA Rifled Slug	1 oz. Rifled Slug	86234	5

See pages 149-157 for ballistics information.

MICHAEL WADDELL



JUDD JARZYKA



Custom Lite[®]

Hornady[®] Custom Lite[®] ammunition provides reduced recoil and muzzle blast from the most popular calibers, and puts the fun back into shooting for kids, women, and every shooter looking to keep recoil to a minimum while still enjoying the use of their favorite rifle. Loaded with the Hornady[®] SST[®] bullet, Custom Lite[®] ammunition is designed to deliver less felt recoil and a modified trajectory that still provides the accurate, deadly, and dependable performance you rely on from Hornady[®].

REDUCED RECOIL

By using slightly lighter bullets and modified propellants, shooters will achieve significant recoil reduction over standard loads.

PROVEN BULLETS

Loaded with SST[®] bullets, Custom Lite[®] ammunition delivers flat trajectories and hard-hitting performance.

CONSISTENT COMPONENTS

Like all Hornady[®] ammunition, we match powders to each load for optimum pressure, velocity and consistency. High quality cases and primers contribute to consistent shooting in the field.

*Keep recoil to
a minimum.*



JOSIE REED



EMILY HANCOCK



25-31% RECOIL REDUCTION*

7 MM - 08 REM 120 GR SST®

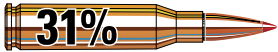

COMPARED TO STANDARD 139 GRAIN LOAD

20 GA 250 GR SST® SLUG



COMPARED TO STANDARD 250 GRAIN LOAD

35-40% RECOIL REDUCTION*

243 WIN 87 GR SST®



COMPARED TO STANDARD 100 GRAIN LOAD

12 GA 300 GR FTX® SLUG



COMPARED TO STANDARD 300 GRAIN LOAD

41%+ RECOIL REDUCTION*

270 WIN 120 GR SST®



COMPARED TO STANDARD 130 GRAIN LOAD

308 WIN 125 GR SST®



COMPARED TO STANDARD 150 GRAIN LOAD

30-06 125 GR SST®



COMPARED TO STANDARD 150 GRAIN LOAD

By using slightly lighter bullets and modified propellants, significant recoil reduction is achieved that will benefit shooters of all ages.

*Recoil reduction is calculated by comparing a standard Custom™ load to a Custom Lite® load based on charge weight, bullet weight and muzzle velocity.

CUSTOM LITE®

CARTRIDGE	BULLET	ITEM	COUNT
243 Win	87 gr. SST®	80466	20
270 Win	120 gr. SST®	80526	20
7mm-08 Rem	120 gr. SST®	80572	20
308 Win	125 gr. SST®	80866	20
30-06 Sprg	125 gr. SST®	81066	20

See pages 149-157 for ballistics information.

Shotgun enthusiasts will enjoy both 20 and 12 gauge offerings, delivering 25% to 40% less recoil than standard loads. For rifled barrels only.

CUSTOM LITE® SLUGS

CARTRIDGE	BULLET	ITEM	COUNT
20 GA Slug 2¾"	250 gr. FTX®	86233	5
12 GA Slug 2¾"	300 gr. FTX®	86230	5

See pages 149-157 for ballistics information.



Varmint Express®

Hornady® Varmint Express® ammunition is designed around the hard-hitting performance of our famous V-MAX® bullet. Polymer tipped V-MAX® bullets deliver match accuracy, high ballistic coefficients, wind defying trajectories, and rapid fragmentation upon contact. Each Varmint Express® offering is loaded with high quality cases and carefully selected propellant and primers that are chosen to provide the best performance in each individual load.

PROVEN BULLETS

Hornady V-MAX® bullets consistently achieve accuracy and rapid fragmentation at all practical varmint shooting velocities.

SELECT BRASS

Brass is chosen to ensure it meets our high standards for reliable feeding, corrosion resistance, proper hardness, and the ability to withstand maximum chamber pressures.

PRIMERS

Like the powder, each primer is carefully matched to individual loads, and all are chosen for their ability to quickly, completely and reliably ignite the powder charge.



Tack-driving accuracy.



V-Max®



VARMINT EXPRESS® CENTERFIRE

CARTRIDGE	BULLET	ITEM	COUNT
22 Hornet	35 gr. V-MAX®	8302	25
223 Rem	55 gr. V-MAX®	8327	20
224 Valkyrie	60 gr. V-MAX®	81531	20
22-250 Rem	50 gr. V-MAX®	8336	20
22-250 Rem	55 gr. V-MAX®	8337	20
220 Swift	55 gr. V-MAX®	8324	20
6mm Creedmoor	87 gr. V-MAX®	81393	20
6.5 Creedmoor	95 gr. V-MAX®	81481	20

See pages 149-157 for ballistics information.



From prairie dogs to coyotes and fox, the Hornady® Rimfire line of ammunition offers varmint hunters high speed rimfire cartridges. Loaded with either the V-MAX® or NTX® bullet, these loads deliver tack-driving accuracy and dramatic expansion on impact.

VARMINT EXPRESS® RIMFIRE

CARTRIDGE	BULLET	ITEM	COUNT
17 Mach 2	15.5 gr. NTX®	83176	50
17 Mach 2	17 gr. V-MAX®	83177	50
17 HMR	15.5 gr. NTX®	83171	50
17 HMR	17 gr. V-MAX®	83170	50
17 HMR	20 gr. XTP®	83172	50
17 WSM	20 gr. V-MAX®	83180	50
22 WMR	30 gr. V-MAX®	83202	50

See pages 149-157 for ballistics information.



Specially loaded to ensure proper functioning in semi-auto and pump shotguns, Hornady® #4 Buckshot provides consistent performance due to our Versatite® wad technology that delivers tight patterns without modification to your gun.

VARMINT EXPRESS® BUCKSHOT

CARTRIDGE	SHOT	ITEM	COUNT
12 GA 2 3/4"	1 oz. #4 Buckshot	86243	10

See pages 149-157 for ballistics information.



Match™

We carefully select every component to ensure uniformity, then load to exacting specifications to provide pinpoint accuracy. Each cartridge is loaded with either Hornady® A-MAX® bullets, our high-performance boattail hollow points, or the new, radically superior ELD® Match bullets. Stringent quality control ensures proper bullet seating, consistent charges and pressures, optimal velocity, consistent overall length and repeatable accuracy.

HORNADY® MATCH™ BULLETS

Hornady® Match™ rifle ammunition is loaded with the most accurate, consistent match bullets in the world, featuring our AMP® bullet jackets.



SPECIALLY SELECTED CASES

Cases are carefully selected based on strict criteria: wall thickness uniformity, internal capacity and consistent wall concentricity.

CAREFULLY MATCHED POWDER

Powder is matched carefully to each specific load for optimal pressure, velocity and consistent accuracy.

STRINGENT QUALITY CONTROL

With extremely tight tolerances and strict quality control, all Hornady Match™ ammunition features superior lot-to-lot consistency. From the bullet seating to the optimal charges and velocities, Hornady® Match™ ammunition is designed to live up to company founder, J.W. Hornady's original goal: "Ten bullets through one hole."

The difference between competing and dominating...



ELD® Match BTHP MATCH A-MAX®

See page 56 for more information on the ELD® Match bullet.

ROBERT BRANTLEY



MATCH™

CARTRIDGE	BULLET	G1 BC	ITEM	COUNT
223 Rem	73 gr. ELD® Match	.398	80269	20
223 Rem	75 gr. BTHP	.395	8026	20
224 Valkyrie	88 gr. ELD® Match	.545	81534	20
6mm Creedmoor	108 gr. ELD® Match	.536	81391	20
260 Rem	130 gr. ELD® Match	.554	8553	20
6.5 Creedmoor	120 gr. ELD® Match	.486	81491	20
6.5 Creedmoor	140 gr. ELD® Match	.610	81500	20
6.5 Creedmoor	147 gr. ELD® Match	.697	81501	20
6.5 PRC	147 gr. ELD® Match	.697	81620	20
308 Win	168 gr. ELD® Match	.523	80966	20
308 Win	168 gr. BTHP	.450	8097	20
308 Win	178 gr. BTHP	.530	8105	20
300 Win Mag	178 gr. ELD® Match	.547	82043	20
300 Win Mag	195 gr. ELD® Match	.584	82180	20
300 PRC	225 gr. ELD® Match	.777	82162	20
300 Norma Mag	225 gr. ELD® Match	.777	82176	20
338 Lapua Mag	250 gr. BTHP	.670	8230	20
338 Lapua Mag	285 gr. ELD® Match	.829	82300	20
50 BMG	750 gr. A-MAX®	1.050	8270	10

See pages 149-157 for ballistics information.

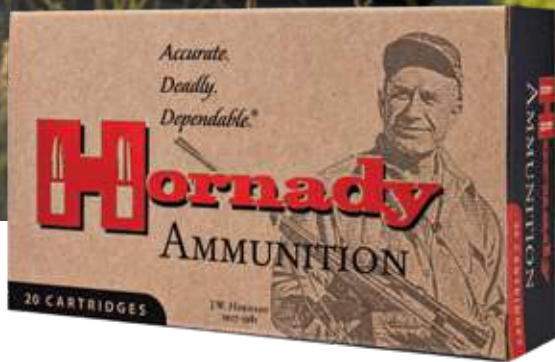

VINTAGE MATCH™

Vintage Match™ ammunition was developed with the match shooter in mind and provides superior quality, off-the-shelf ammunition for the shooter who is looking for a match grade alternative to surplus or hand-loaded ammunition.

VINTAGE MATCH™

CARTRIDGE	BULLET	G1 BC	ITEM	COUNT
30-06 Sprg M1 Garand	168 gr. ELD® Match	.523	81171	20
8X57 JS	196 gr. BTHP	.525	82298	20

See pages 149-157 for ballistics information.

SUPERFORMANCE® MATCH™

Highpower competitors benefit from the Superformance® Match™ advantages – higher muzzle velocity, phenomenal accuracy, increased range and reduced wind drift.

SUPERFORMANCE® MATCH™

CARTRIDGE	BULLET	G1 BC	ITEM	COUNT
223 Rem	75 gr. BTHP	.395	80264	20
5.56 NATO*	75 gr. BTHP	.395	81264	20
308 Win	168 gr. ELD® Match	.523	80963	20

See pages 149-157 for ballistics information.

* 5.56 NATO ammunition is not for use in rifles chambered in 223 Rem. Superformance® Match™ ammunition may not be compatible with all gas operated firearms.



Dangerous Game™ Series

Hornady® manufactures Dangerous Game™ Series ammunition with only the finest components, under strict quality control measures. Our classic bullet designs are tailored to meet the needs of the serious safari hunter. We use techniques and processes that rival hand loads, with the ultimate goal of making every cartridge accurate, deadly and dependable!

HIGH PERFORMANCE HORNADY® BULLETS

From the InterLock® SP-RP bullets to the heavy-hitting DGS® and DGX® Bonded bullets, each Dangerous Game™ Series load is topped with a deadly projectile.

POWDER

Powders are carefully matched to each load to ensure optimum pressure and velocity, and to regulate in double rifles. Some of our Dangerous Game™ Series loads feature Superformance® propellant technology.

CASE AND PRIMER

Like all Hornady® ammunition, our Dangerous Game™ ammunition uses the highest quality cases and primers available. Consistent components translate to consistent shooting in the field.

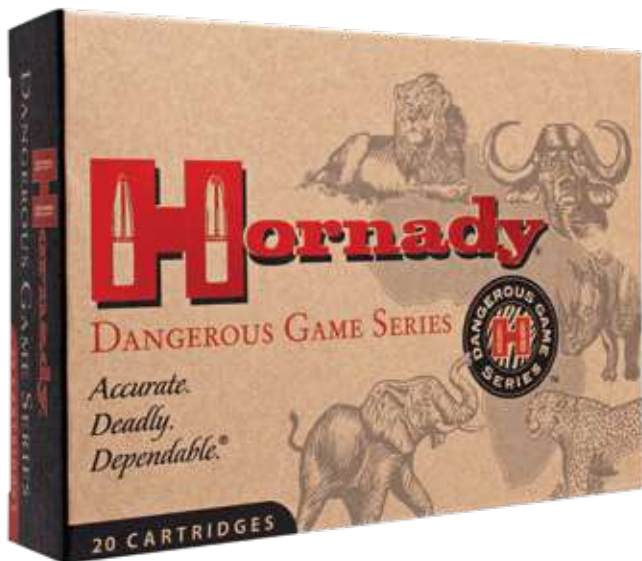

InterLock® SP-RP



DGS®



DGX® Bonded

Fear no evil.

INTERLOCK® SP-RP BULLETS

SP-RP stands for "spire point - recoil proof," and the design of this bullet eliminates the problem of tip deformation during recoil. These heavy-duty InterLock® bullets combine rugged design with improved trajectory in dangerous game rifles.

DGS® BULLETS

The DGS® non-expanding bullet is recommended for follow-up shots on thick-skinned game such as elephant, rhino and hippo. Its tough copper clad steel jacket is designed to provide maximum penetration from all angles on thick-skinned and heavy boned dangerous game animals.

DGX® BONDED BULLETS

The DGX® Bonded bullet features a copper-clad steel jacket bonded to a lead core to provide limited, controlled expansion with deep penetration and high weight retention.



CHAD STEARNS



CAMERON MITCHELL



DANGEROUS GAME™ SERIES

CARTRIDGE	BULLET	ITEM	COUNT
9.3 x 62	286 gr. InterLock® SP-RP	82303	20
9.3 x 74R	286 gr. InterLock® SP-RP	82304	20
376 Steyr	225 gr. InterLock® SP-RP	8234	20
376 Steyr	270 gr. InterLock® SP-RP	8237	20
375 H&H Mag Superformance®	270 gr. InterLock® SP-RP	8508	20
375 H&H Mag	300 gr. DGX® Bonded	82334	20
375 H&H Mag	300 gr. DGS®	82322	20
375 Ruger	270 gr. InterLock® SP-RP	8231	20
375 Ruger	300 gr. DGX® Bonded	82336	20
375 Ruger	300 gr. DGS®	8232	20
450-400 Nitro Express 3"	400 gr. DGX® Bonded	82432	20
450-400 Nitro Express 3"	400 gr. DGS®	8242	20
416 Ruger	400 gr. DGX® Bonded	82667	20
416 Ruger	400 gr. DGS®	82666	20
416 Rem Mag	400 gr. DGX® Bonded	82672	20
416 Rem Mag	400 gr. DGS®	82674	20
416 Rigby	400 gr. DGX® Bonded	82661	20
416 Rigby	400 gr. DGS®	8265	20

DANGEROUS GAME™ SERIES

CARTRIDGE	BULLET	ITEM	COUNT
500-416 Nitro Express	400 gr. DGX® Bonded	82683	20
500-416 Nitro Express	400 gr. DGS®	82682	20
404 Jeffery	400 gr. DGX® Bonded	82381	20
404 Jeffery	400 gr. DGS®	8239	20
450 Rigby	480 gr. DGX® Bonded	82668	20
450 Rigby	480 gr. DGS®	82662	20
450 Nitro Express 3¼"	480 gr. DGX® Bonded	8257	20
450 Nitro Express 3¼"	480 gr. DGS®	8256	20
458 Win Mag Superformance®	500 gr. DGX® Bonded	85834	20
458 Win Mag Superformance®	500 gr. DGS®	8585	20
458 Lott	500 gr. DGX® Bonded	82614	20
458 Lott	500 gr. DGS®	8262	20
470 Nitro Express	500 gr. DGX® Bonded	82631	20
470 Nitro Express	500 gr. DGS®	8264	20
500 Nitro Express 3"	570 gr. DGX® Bonded	82689	20
500 Nitro Express 3"	570 gr. DGS®	8269	20

See pages 149-157 for ballistics information.



Custom™

Millions of successful hunts have proven the accuracy and deadly effect of the famous Hornady® InterLock®, SST®, InterBond®, V-MAX®, FTX®, and GMX® bullets we load into Hornady® Custom™ rifle ammunition.

Every round of Hornady® Custom™ ammunition is hand inspected before packaging to ensure the highest levels of quality control. At Hornady®, we manufacture Custom™ ammunition to give shooters and hunters the advantage of handloaded accuracy in a factory load.

HORNADY® BULLETS

Available in a wide variety of hunting calibers, Custom™ ammunition is loaded with InterLock®, SST®, InterBond®, V-MAX®, FTX®, and GMX® bullets, providing an all-around line of hunting ammunition for your preferred shooting experience.

EXPANSION AND PENETRATION

An industry leader and customer favorite, Custom™ ammunition balances expansion and penetration and is well-suited to medium and large sized game.

BALLISTIC EFFICIENCY

Most Custom™ loads feature bullets with a secant ogive design. This pioneering profile, developed by Hornady®, creates the optimum blend of ballistic efficiency and bearing surface for flatter shooting and less drag.



Innovation since 1949.

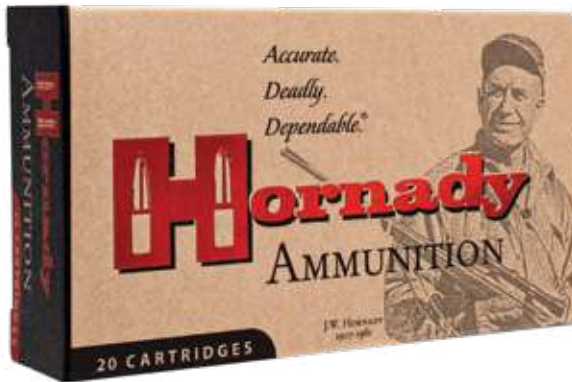

JUSTIN SCOTT



BRAD SCHMIDT

JASON MORTON





MATT WILLSON



CUSTOM™

CARTRIDGE	BULLET	ITEM	COUNT
22 Hornet	45 gr. SP Match™	83028	50
218 Bee	45 gr. HP	8307	20
223 Rem	55 gr. SP	80255	50
223 Rem	55 gr. FMJ/BT	80275	50
243 Win	87 gr. V-MAX®	80468	20
250 Savage	100 gr. InterLock® SP	8132	20
6.5 Grendel	123 gr. SST®	8152	20
264 Win Mag	140 gr. InterLock® SP	8154	20
6.8mm SPC	100 gr. GMX®	83481	20
6.8mm SPC	120 gr. SST®	8347	20
275 Rigby	140 gr. InterLock® SP	8070	20

CUSTOM™

CARTRIDGE	BULLET	ITEM	COUNT
300 Blackout	110 gr. GMX®	80879	20
300 Blackout	135 gr. FTX®	80881	20
308 Win	150 gr. SST®	8093	20
30-40 Krag	180 gr. InterLock® SP	81202	20
300 H&H Mag	180 gr. InterBond®	8210	20
303 British	150 gr. InterLock® SP	8225	20
350 Legend	NEW 165 gr. FTX®	81197	20
358 Win	200 gr. InterLock® SP	91318	20
405 Win	300 gr. InterLock® SP	8241	20
450 Bushmaster	250 gr. FTX®	82244	20

See pages 149-157 for ballistics information.



American Gunner®

The American Gunner® line of ammunition is a collection of tried-and-true, versatile loads that are popular with shooters for their target shooting, hunting or self-defense needs.

Made in the USA with premium components, American Gunner® ammunition combines generations of ballistics know-how with modern technology.

Hornady® offers rifle calibers and shotgun loads to complement the handgun offerings. Rifle options are loaded with match grade hollow point bullets for a broad range of use including self-defense, target shooting, and varmint/small game hunting.

HORNADY® BULLETS

XTP® (eXtreme Terminal Performance), HP and BTHP bullets are exceptionally accurate and deliver excellent versatility and superior ballistic performance.

VERSATILE AND FUN

Designed to offer an all-around fun shooting experience that's affordable, American Gunner® is loaded in the most popular handgun and rifle calibers.

QUALITY BRASS, PRIMERS AND PROPELLANT

Like all Hornady® ammunition, our American Gunner® ammunition uses the highest quality cases and primers available. Loaded to conventional velocities, American Gunner® functions in any gun. Consistent components translate to consistent shooting in the field.

Life. Liberty. Hornady.®



American Gunner® ammunition is available in rifle, handgun and shotgun loads.



223 Rem
55 gr. HP



9mm 124 gr. XTP®



45 Cal. 185 gr. XTP®

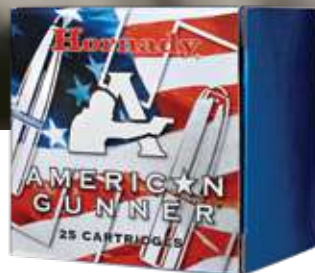

AMERICAN GUNNER® RIFLE

CARTRIDGE	BULLET	ITEM	COUNT
223 Rem	55 gr. HP Match™	80237	50
6.5 Creedmoor	140 gr. BTHP Match™	81482	50
300 Blackout	125 gr. HP Match™	80897	50
308 Win	155 gr. BTHP Match™	80967	50
7.62x39	NEW 123 gr. HP Match™	80786	50

See pages 149-157 for ballistics information.

AMERICAN GUNNER® PISTOL

CARTRIDGE	BULLET	ITEM	COUNT
380 Auto	90 gr. XTP®	90104	25
9mm Luger	115 gr. XTP®	90244	25
9mm Luger +P	124 gr. XTP®	90224	25
38 Spl	125 gr. XTP®	90324	25
357 Mag	125 gr. XTP®	90504	25
40 S&W	180 gr. XTP®	91364	20
45 Auto	185 gr. XTP®	90904	20

See pages 149-157 for ballistics information.

AMERICAN GUNNER® SHOTGUN

CARTRIDGE	BULLET/SHOT	ITEM	COUNT
12 GA Reduced Recoil™	1 oz. Rifled Slug	86231	5
12 GA Reduced Recoil™	00 Buckshot	86274	10

See pages 149-157 for ballistics information.



Frontier® Cartridge

American made and military grade are the hallmarks of Frontier® Cartridge, a new Hornady® division. Placing an emphasis on quality and variety, Frontier® Cartridge features Hornady® bullets in 223 Rem, 5.56 NATO, 6.5 Grendel, and 300 Blackout offerings to suit the needs of all shooters.

State-of-the-industry loading techniques and quality control procedures ensure the reliability of every Frontier® Cartridge round.

ROUNDS FOR ALL APPLICATIONS

Frontier® Cartridge offers ammunition configured for a wide range of shooters and applications, everything from plinking, target shooting and hunting to law enforcement training and self-defense.

MILITARY GRADE

In addition to Hornady® bullets in a variety of offerings, Frontier® Cartridge features brass cartridge cases and military-grade boxer primers and propellant.

NEW FOR 2020!

6.5 Grendel
123 gr. FMJ

No. FR700

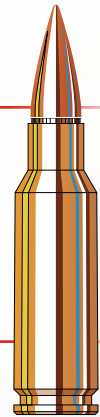

American Made. Military Grade.





Photo Credit: Travis Gibson

FRONTIER® CARTRIDGE

CARTRIDGE	BULLET	ITEM	COUNT
223 Rem	55 gr. FMJ	FR100	20
223 Rem	NEW 55 gr. FMJ	FR1005	50 (oriented)
223 Rem	55 gr. FMJ	FR1015	150 (oriented)
223 Rem	55 gr. FMJ	FR104	500 (loose)*
223 Rem	55 gr. FMJ	FR106	1000 (loose)*
223 Rem	55 gr. FMJ	FR100B	13889 (loose)*
223 Rem	55 gr. Spire Point	FR120	20
223 Rem	55 gr. Spire Point	FR1215	150 (oriented)
223 Rem	55 gr. Hollow Point Match™	FR140	20
223 Rem	NEW 55 gr. Hollow Point Match™	FR1405	50 (oriented)
223 Rem	55 gr. Hollow Point Match™	FR1415	150 (oriented)
223 Rem	68 gr. BTHP Match™	FR160	20

FRONTIER® CARTRIDGE

CARTRIDGE	BULLET	ITEM	COUNT
5.56 NATO	55 gr. FMJ (XM193)	FR200	20
5.56 NATO	NEW 55 gr. FMJ (XM193)	FR2005	50 (oriented)
5.56 NATO	55 gr. FMJ (XM193)	FR2015	150 (oriented)
5.56 NATO	55 gr. FMJ (XM193)	FR204	500 (loose)*
5.56 NATO	55 gr. FMJ (XM193)	FR206	1000 (loose)*
5.56 NATO	55 gr. FMJ (XM193)	FR200B	13889 (loose)*
5.56 NATO	55 gr. Hollow Point Match™	FR240	20
5.56 NATO	NEW 55 gr. Hollow Point Match™	FR2405	50 (oriented)
5.56 NATO	55 gr. Hollow Point Match™	FR2415	150 (oriented)
5.56 NATO	62 gr. FMJ	FR260	20
5.56 NATO	62 gr. FMJ	FR2615	150 (oriented)
5.56 NATO	62 gr. FMJ	FR266	1000 (loose)*

FRONTIER® CARTRIDGE

CARTRIDGE	BULLET	ITEM	COUNT
5.56 NATO	62 gr. FMJ	FR260B	13889 (loose)*
5.56 NATO	62 gr. Spire Point	FR280	20
5.56 NATO	NEW 62 gr. Spire Point	FR2815	150 (oriented)
5.56 NATO	62 gr. BTHP Match™	FR300	20
5.56 NATO	68 gr. BTHP Match™	FR310	20
5.56 NATO	75 gr. BTHP Match™	FR320	20
6.5 Grendel	NEW 123 gr. FMJ	FR700	20
300 Blackout	125 gr. FMJ	FR400	20
300 Blackout	NEW 125 gr. FMJ	FR401	50 (oriented)
300 Blackout	NEW 125 gr. FMJ	FR402	150 (oriented)

See pages 149-157 for ballistics information.

*Loose-pack ammo. Ships via ground freight only.



Handgun Hunter™ **NEW**

Hornady Handgun Hunter™ ammunition is built around a bullet as rough and rugged as the conditions and game demand. The MonoFlex® handgun projectile is manufactured with a tough copper alloy that achieves deep penetration and 95% weight retention. Bullet expansion across a range of velocities is aided with an elastomer material added to the bullet's open cavity. Upon impact, the elastomer compresses, then pushes out and causes the bullet to expand faster than a standard hollow point design. Combined with premium cases, primers and propellants, Handgun Hunter™ ammunition benefits from years of producing hard-hitting GMX® and MonoFlex® rifle bullets to introduce a handgun version that lives up to our reputation.

MONOFLEX® BULLET TECHNOLOGY

The tough copper alloy in the MonoFlex® bullet allows for deep penetration while retaining 95% of its weight for maximum impact.

ELASTOMER MATERIAL

Elastomer material in the bullet's open cavity compresses upon impact and then pushes out, causing rapid expansion.

PREMIUM COMPONENTS

Premium cases, primers and propellants combine with the MonoFlex® bullet to create a cartridge that delivers superior performance in the field.





NEAL EMERY



ERIC CONN



HANDGUN HUNTER™

CARTRIDGE		BULLET	ITEM	COUNT
9mm Luger +P	NEW	115 gr. MonoFlex®	90281	25
357 Mag	NEW	130 gr. MonoFlex®	9052	25
40 S&W	NEW	135 gr. MonoFlex®	91361	20
10mm Auto	NEW	135 gr. MonoFlex®	91267	20
44 Rem Mag	NEW	200 gr. MonoFlex®	9083	20
454 Casull	NEW	200 gr. MonoFlex®	9151	20
460 S&W	NEW	200 gr. MonoFlex®	9153	20

See pages 149-157 for ballistics information.



Custom™ Pistol

At Hornady®, we have introduced over 60 different jacketed pistol bullets based on what you, the shooter, have requested. All Hornady® Custom™ pistol ammo is loaded with the famous XTP® (eXtreme Terminal Performance) bullet, FTX® (Flex Tip® eXpanding) bullet, or our swaged lead Cowboy™ bullets.

All are extremely accurate and deliver excellent performance! This is what makes our pistol bullets the preferred choice for hunters, competitive shooters, and plinkers.

HORNADY® BULLETS

All Hornady® Custom™ pistol ammo is loaded with either the famous Hornady® XTP® (eXtreme Terminal Performance) bullet, our patented FTX® bullet, or our swaged lead Cowboy™ bullet. All are supremely accurate and deliver dependable performance.

VERSATILE

Whether you're working up the perfect handgun for hunting, competition, or self-defense applications, Hornady® Custom™ Pistol provides the most reliable ammo with the widest range of terminal velocities. Harness all the versatility your handguns can offer, whether loading for the woods, the street, or even the medal round.



The preferred choice.

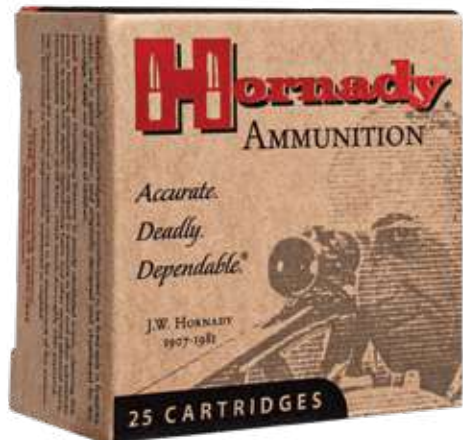

38 Cal 158 gr. XTP®





MIKE CLERKIN



CUSTOM™ PISTOL

CARTRIDGE	BULLET	ITEM	COUNT
25 Auto	35 gr. XTP®	90012	25
32 Auto	60 gr. XTP®	90062	25
9mm Luger	124 gr. XTP®	90242	25
9mm Luger	147 gr. XTP®	90282	25
357 Sig	147 gr. XTP®	9131	20
38 Spl	158 gr. XTP®	90362	25
357 Mag	158 gr. XTP®	90562	25
40 S&W	155 gr. XTP®	9132	20
10mm Auto	155 gr. XTP®	9122	20
10mm Auto	180 gr. XTP®	9126	20
41 Rem Mag	210 gr. XTP®	9077	20
44-40 Win Cowboy	205 gr. Cowboy™	9075	20
44 Rem Mag	200 gr. XTP®	9080	20

CUSTOM™ PISTOL

CARTRIDGE	BULLET	ITEM	COUNT
44 Rem Mag	240 gr. XTP®	9085	20
44 Rem Mag	300 gr. XTP®	9088	20
45 Auto	200 gr. XTP®	9112	20
45 Auto +P	230 gr. XTP®	9096	20
45 Colt	255 gr. Cowboy™	9115	20
454 Casull	240 gr. XTP® MAG	9148	20
454 Casull	300 gr. XTP® MAG	9150	20
460 S&W Mag	200 gr. FTX®	9152	20
480 Ruger	325 gr. XTP® MAG	9138	20
50 AE	300 gr. XTP®	9245	20
500 S&W Mag	300 gr. FTX®	9249	20
500 S&W Mag	500 gr. XTP®	9252	20

See pages 149-157 for ballistics information.

Critical Duty®

The patented FlexLock® bullet delivers barrier blind performance.

Designed to meet the needs of those who demand superior barrier penetration and prefer a full-size handgun for their personal protection. Critical Duty® is loaded with the tough Hornady® FlexLock® bullet that delivers “barrier blind” performance when shot through common urban barriers.

The patented FlexLock® bullet incorporates two revolutionary Hornady® features, delivering superior barrier penetration and consistent performance in FBI tactical handgun ammunition tests (FBI Protocol).

The patented Hornady® Flex Tip® design eliminates clogging and aids bullet expansion. A large mechanical jacket-to-core InterLock® band works to keep the bullet and core from separating for maximum weight retention, excellent expansion, consistent penetration and terminal performance through all FBI test barriers.

Bright nickel-plated cases simplify chamber checks in reduced light. Additionally, all Critical Duty® ammunition is loaded with low flash propellant to help preserve night vision in low-light firing.

FLEXLOCK® BULLET

Incorporates two revolutionary Hornady® features: the no-clog, patented Flex Tip® design and the heavy duty jacket-to-core InterLock® band.

INTERLOCK® BAND

Works to keep the bullet and core from separating for maximum weight retention and proven terminal performance through all FBI test barriers.

CORE

Made of high-antimony lead making it extremely tough, delivering controlled expansion for unparalleled terminal performance consistency through all FBI test barriers. It's also more economical than similar bonded bullets.

NICKEL-PLATED CRIMPED CASES

Nickel plating resists corrosion and greatly enhances low-light chamber checks. The cannellured bullet with crimped case ensures no bullet setback during feeding.



The FBI completed an extensive evaluation process and selected Hornady® Critical Duty® as its source for 9mm +P and 40 S&W pistol ammunition.

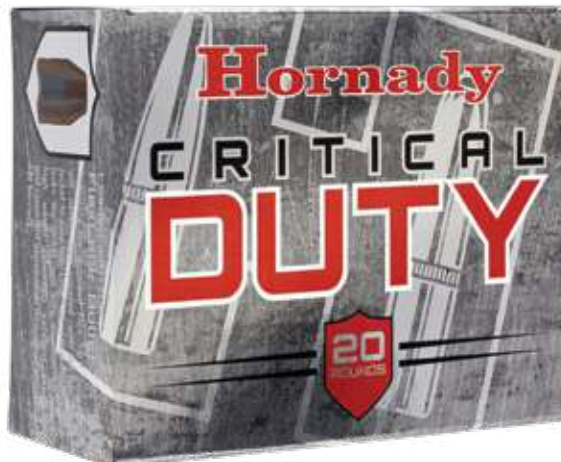

U.S. Patent No. 8,413,587



CRITICAL DUTY®

CARTRIDGE	BULLET	ITEM	COUNT
9mm Luger	135 gr. FlexLock®	90236	25
9mm Luger +P	124 gr. FlexLock®	90216	25
9mm Luger +P	135 gr. FlexLock®	90226	25
357 Sig	135 gr. FlexLock®	91296	20
357 Mag	135 gr. FlexLock®	90511	25
40 S&W	175 gr. FlexLock®	91376	20
10mm Auto	175 gr. FlexLock®	91256	20
45 Auto +P	220 gr. FlexLock®	90926	20

See pages 149-157 for ballistics information.

FBI TESTED AND SELECTED

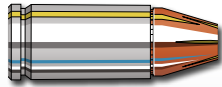

9mm Luger +P 124 gr. FlexLock®

BARE GELATIN



14.5" penetration | 0.54" expansion
100% recovered weight

HEAVY CLOTHING



15.5" penetration | 0.51" expansion
100% recovered weight

GLASS



13.25" penetration | 0.41" expansion
72% recovered weight

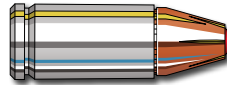

9mm Luger 135 gr. FlexLock®



15.25" penetration | 0.56" expansion
100% recovered weight



15.5" penetration | 0.50" expansion
100% recovered weight



13.75" penetration | 0.41" expansion
67% recovered weight

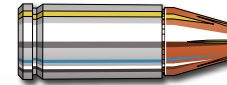

9mm Luger +P 135 gr. FlexLock®

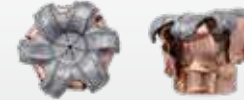

14.0" penetration | 0.60" expansion
100% recovered weight



15.0" penetration | 0.55" expansion
100% recovered weight

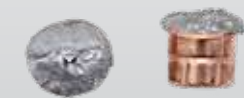

14.75" penetration | 0.42" expansion
69% recovered weight

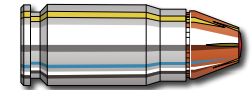

357 Sig 135 gr. FlexLock®



14.0" penetration | 0.58" expansion
99% recovered weight



13.5" penetration | 0.56" expansion
99% recovered weight



15.5" penetration | 0.49" expansion
77% recovered weight

FBI TESTED AND SELECTED

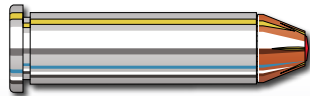

357 Mag 135 gr. FlexLock®

BARE GELATIN



14.0" penetration | 0.58" expansion
99% recovered weight

HEAVY CLOTHING



14.4" penetration | 0.57" expansion
99% recovered weight

GLASS

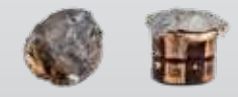

14.1" penetration | 0.46" expansion
73% recovered weight

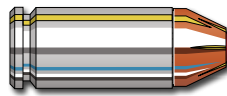

40 S&W 175 gr. FlexLock®



13.5" penetration | 0.57" expansion
99% recovered weight



14.5" penetration | 0.54" expansion
99% recovered weight



13.0" penetration | 0.61" expansion
79% recovered weight

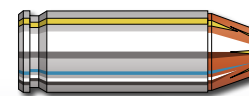

10mm Auto 175 gr. FlexLock®



13.25" penetration | 0.66" expansion
99% recovered weight



14.5" penetration | 0.63" expansion
99% recovered weight



14.0" penetration | 0.55" expansion
80% recovered weight



45 Auto +P 220 gr. FlexLock®



14.0" penetration | 0.71" expansion
99% recovered weight



14.5" penetration | 0.69" expansion
99% recovered weight



13.75" penetration | 0.53" expansion
75% recovered weight



Critical Defense®

Since their inception, conventional hollow point pistol bullets have performed well, but have never delivered 100% reliability, especially in self-defense situations. The patented Flex Tip® technology used in Critical Defense® ammunition eliminates the clogging and inconsistency that often plagues hollow point bullets. Hornady® achieved this by using the same tip material used in LEVERevolution® ammunition.

All Critical Defense® ammunition is loaded in nickel-plated cases for increased visibility in low-light situations. Premium low flash propellants deliver proven performance, even in very short-barreled handguns, and won't disrupt your vision. Reliable expansion and dependable terminal performance can be counted on for concealed carry and personal protection

FTX® BULLET TECHNOLOGY

The patented FTX® bullet expands reliably and resists clogging when fired through heavy clothing.

DEFENSE-CENTERED DESIGN

Critical Defense® ammunition was developed to provide the best performance for defensive or personal protection situations and is the ultimate choice for any short barreled, concealed carry style firearm. Bright nickel-plated cartridge cases simplify chamber checks in reduced light, and low-flash propellants help preserve night vision.

DEPENDABLE

Details such as nickel-plated cases that resist corrosion and optimized propellants that burn quickly to reduce recoil and limit muzzle flash, help ensure that Critical Defense® ammo is dependable in every situation.

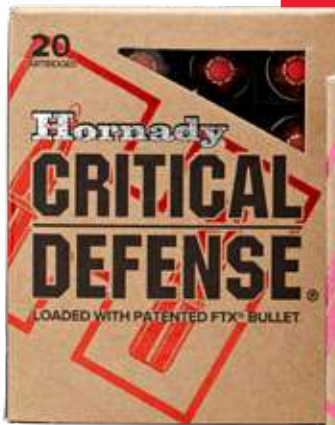

THE #1 CONCEALED CARRY BRAND ON THE MARKET!

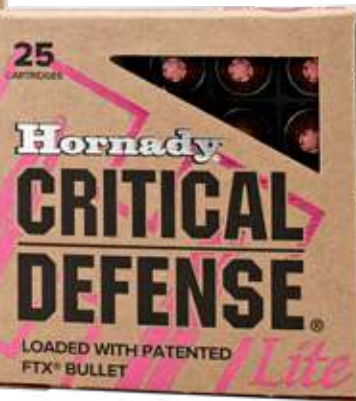

40 S&W 165 gr. FTX®



9mm 115 gr. FTX®

U.S. Patent No. 8,413,587



CRITICAL DEFENSE® LITE™

Critical Defense® Lite™ ammunition offers an effective, reduced recoil option for any shooter looking to minimize felt recoil of their lightweight, compact personal protection firearm.

CRITICAL DEFENSE® PISTOL

CARTRIDGE	BULLET	ITEM	COUNT
22 WMR	45 gr. FTX®	83200	50
25 Auto	35 gr. FTX®	90014	25
32 Auto	60 gr. FTX®	90063	25
32 NAA	80 gr. FTX®	90070	25
32 H&R Mag	80 gr. FTX®	90060	25
327 Federal Mag	NEW 80 gr. FTX®	90061	25
380 Auto	90 gr. FTX®	90080	25
9mm Luger Critical Defense® Lite	100 gr. FTX®	90240	25
9mm Luger	115 gr. FTX®	90250	25
38 Spl Critical Defense® Lite	90 gr. FTX®	90300	25
38 Spl	110 gr. FTX®	90310	25
38 Spl +P	110 gr. FTX®	90311	25
357 Mag	125 gr. FTX®	90500	25
9x18 Makarov	95 gr. FTX®	91000	25
40 S&W	165 gr. FTX®	91340	20
44 Spl	165 gr. FTX®	90700	20
45 Auto	185 gr. FTX®	90900	20
45 Colt	185 gr. FTX®	92790	20

See pages 149-157 for ballistics information.

Critical Defense®

Critical Defense® Shotgun

CRITICAL DEFENSE® SHOTGUN 410 TRIPLE DEFENSE®

Delivering effective shot patterns that place all projectiles on a man-sized target at seven yards, the Critical Defense® 410 features a unique Triple Defense® projectile column consisting of two 35 caliber round balls topped with one non-jacketed FTX® slug.



CRITICAL DEFENSE® SHOTGUN

CARTRIDGE	BULLET	ITEM	COUNT
410 Triple Defense®	FTX® Slug & 2 round balls	86238	20
12 GA 00 Buckshot	8 pellets	86240	10

See pages 149-157 for ballistics information.

A new breed of FTX® bullets are at the forefront of the Critical Defense® Rifle ammunition line. The bullet's patented Flex Tip® not only helps keep the nose cavity free from clogging as it passes through heavy clothing but also helps the bullet expand at low velocities from short-barreled rifles or at extended ranges.

Designed for short-range defensive situations, Critical Defense® Rifle delivers rapid expansion for reduced potential of over-penetration.

FTX® BULLET TECHNOLOGY

The unique design of the Critical Defense® FTX® bullet offers quick expansion and limited penetration for home and self defense. The patented FTX® bullet expands reliably and resists clogging when fired through heavy clothing.

NICKEL-PLATED CASES

Silver nickel-plated cases feed smoothly and are more visible for chamber checks in low-light situations.

QUALITY PROPELLANT

Propellants deliver consistent performance regardless of environmental conditions.

REDUCED MUZZLE FLASH

Additives blended with propellants reduce flash to maintain night vision.

CRITICAL DEFENSE® RIFLE

CARTRIDGE	BULLET	ITEM	COUNT
223 Rem	55 gr. FTX®	80270	20
223 Rem	73 gr. FTX®	80260	20
30 Carbine	110 gr. FTX®	81030	25
308 Win	155 gr. FTX®	80920	20

See pages 149-157 for ballistics information.



308 Win 155 gr. FTX®



Shotgun Slugs

Hornady offers a variety of slugs that offer accuracy and exceptional terminal performance.

Slugs are available in both 20 and 12 gauge with a variety of different projectiles. The SST® Slug has been a favorite for years, while new additions like Superformance® and American Whitetail® offer even more choice in velocity, projectile design and weight retention. The Custom Lite® line offers a reduction in recoil without sacrificing terminal performance. Regardless of your choice, we're certain you'll find a solution that produces a successful harvest this fall.



SST®

Hornady® SST® Shotgun Slugs feature patented Flex Tip® technology. Take the proven performance of our accurate bullet and transform your favorite rifled barrel slug gun into a firearm that outperforms some centerfire rifles. In both 12 gauge and the 20 gauge cartridges, Hornady® SST® Shotgun Slugs deliver sub-3" groups at 100 yards.

FOR FULLY RIFLED BARRELS

SST® SLUGS

CARTRIDGE	WEIGHT	ITEM	COUNT
20 GA SST® Slug 2¾"	250 gr. SST®	86232	5
12 GA SST® Slug 2¾"	300 gr. SST®	8623	5

See pages 149-157 for ballistics information.



MONOFLEX®

At the heart of the Superformance® Shotgun slug is the MonoFlex® projectile with Flex Tip® design that works as a catalyst for uniform expansion, even at low velocities. The MonoFlex® won't separate and retains 95% of its original weight. Fueled by our specially blended propellants, the Superformance® Shotgun Slug is built to deliver maximum velocity for flatter trajectories and enhanced terminal performance.

FOR FULLY RIFLED BARRELS

SUPERFORMANCE® SLUGS

CARTRIDGE	WEIGHT	ITEM	COUNT
12 GA Slug 2¾"	300 gr. MonoFlex®	86236	5

See pages 149-157 for ballistics information.



FTX®

Shotgun slugs deliver a fair amount of recoil. Now, hunters have an alternative with the Custom Lite® Shotgun Slug. This load is ideal for kids, women or anyone looking to tame the recoil of their rifled barrel slug gun — offering 25% to 40% less felt recoil compared to standard 20 and 12 gauge options.

FOR FULLY RIFLED BARRELS

CUSTOM LITE® SLUGS

CARTRIDGE	WEIGHT	ITEM	COUNT
20 GA Slug 2¾"	250 gr. FTX®	86233	5
12 GA Slug 2¾"	300 gr. FTX®	86230	5

See pages 149-157 for ballistics information.



AMERICAN WHITETAIL® SHOTGUN SLUGS

FOR SMOOTH BORE BARRELS

Designed for smooth bore barrels, Hornady® American Whitetail® Rifled Slugs feature a 1-ounce lead alloy slug that is loaded to 1,600 feet per second. A compression-style wad protects the slug at ignition and helps to seal the bore for maximum velocity.



FOR FULLY RIFLED BARRELS

Designed for fully rifled barrels, Hornady® American Whitetail® Slugs are loaded with 325-grain Hornady® InterLock® bullets. A hollow point serrated design initiates rapid expansion upon impact, and a tough, lead alloy core is lethal out to 200+ yards. The rigid polycarbonate driver in the sabot ensures accuracy. The end result is an accurate delivery system for a tough shotgun slug capable of taking the biggest midwestern whitetails.



AMERICAN WHITETAIL® SLUGS

CARTRIDGE	WEIGHT	ITEM	COUNT
12 GA Slug 2¾"	325 gr. HP	86271	5
12 GA Rifled Slug 2¾"	1 oz. Rifled Slug	86234	5

See pages 149-157 for ballistics information.



Heavy Magnum® Shotgun



EMILY MIERAU

Emily shot this turkey with Hornady Heavy Magnum Turkey ammunition.



HEAVY MAGNUM® TURKEY

Heavy Magnum® Turkey delivers true gobbler knockdown power! Shot deformation is minimized, thanks to the thickest nickel-plating in the industry, which reduces fliers and keeps more pellets on target for dense patterns.

The Hornady® Versatite® wad does the patterning, so these loads don't require shotgun modifications or specialized turkey chokes. At 1300 fps for the 12 gauge load, and 1200 fps for the 20 gauge load, Heavy Magnum® Turkey ammunition allows hunters to achieve lethal results out to 50 yards.

HEAVY MAGNUM® TURKEY

CARTRIDGE	SHOT	ITEM	COUNT
20 GA Heavy Magnum® Turkey 3"	1½ oz. #5	86248	10
12 GA Heavy Magnum® Turkey 3"	1½ oz. #4	86242	10
12 GA Heavy Magnum® Turkey 3"	1½ oz. #5	86241	10
12 GA Heavy Magnum® Turkey 3"	1½ oz. #6	86244	10

See pages 149-157 for ballistics information.

FEATURING THE
VERSATITE®
WAD



LES JOHNSON

Les Johnson shot this coyote with Hornady Heavy Magnum Coyote ammunition.



HEAVY MAGNUM® COYOTE

Hornady® Heavy Magnum® Coyote loads deliver lethal results and minimal pelt damage out to 50 yards. Loaded with 1½ ounces of nickel plated lead shot in your choice of BB or 00 buckshot, these 3 inch, 12 gauge shotshells are the perfect answer for close range predators. Both loads feature the Hornady® Versatite® wad that strips cleanly from the shot string for excellent pattern density and a short shot column for maximum effect on target. Not only are these loads extremely effective, they're also an economical choice when compared to expensive tungsten options.

HEAVY MAGNUM® COYOTE

CARTRIDGE	SHOT	ITEM	COUNT
12 GA Heavy Magnum® Coyote 3"	1½ oz. BB	86222	10
12 GA Heavy Magnum® Coyote 3"	1½ oz. 00 Buckshot	86224	10

See pages 149-157 for ballistics information.

Muzzleloading

Whether it's the rolling smoke or the deep booming sound of a muzzleloader, the challenge of shooting a tight group with a primitive firearm is enjoyable and satisfying to hunters who prefer a traditional muzzleloading rifle. Hornady® appreciates this elite group of shooters and offers the products to make their experience successful.

HORNADY® ROUND BALLS

Completely uniform in size, weight, and roundness, Hornady® Round Balls deliver consistent and accurate performance. They're cold swaged from pure lead which eliminates air pockets and voids common to cast soft balls. And the smoother, rounder surface assures better rotation, consistency, and easy loading.



CAL	DIA	ITEM	COUNT
32 cal.	.310	6000	100
32 cal.	.315	6003	100
36 cal.	.350	6010	100
36 cal.	.375	6020	100

CAL	DIA	ITEM	COUNT
40 cal.	.395	6025	100
44 cal.	.433	6030	100
45 cal.	.440	6040	100
45 cal.	.445	6050	100

CAL	DIA	ITEM	COUNT
44 cal.	.451	6060	100
44 cal.	.454	6070	100
45 cal.	.457	6080	100
50 cal.	.480	6088	100

CAL	DIA	ITEM	COUNT
50 cal.	.490	6090	100
50 cal.	.495	6093	100
54 cal.	.520	6095	100
54 cal.	.530	6100	100

CAL	DIA	ITEM	COUNT
54 cal.	.535	6110	100
58 cal.	.570	6120	50

See pages 149-157 for ballistics information.

IMPORTANT: Before choosing a round ball diameter, check the bore size of your firearm and take into consideration whether you're using compression fit or patched projectile loading.

HARD BALLS & PLASTIC PATCH

Created using an extra hard alloy, Hard Balls offer superior penetration and fly true to the target every time. Their specially designed plastic patch also makes them easy to load.



50 Cal .485
Hard Ball System
No. 6950

GREAT PLAINS BULLETS

Pre-lubricated for easy loading, the tapered base lets you start the bullet easily. Cold forming from pure lead eliminates air pockets and the thin skirt, long bearing surface, and hollow point bullet design make it a highly devastating and accurate black powder legend.



50 Cal. 385 gr. Hollow Base
Hollow Point (20 ct.)
No. 6620

PA CONICAL BULLETS

For those using a longer barreled, slower twist firearm, this heavier conical style 50 caliber bullet has about 35% more weight than a typical lead round ball. On impact, it provides reliable terminal performance and better penetration than a typical lead round ball.



50 Cal. 240 gr. PA Conical
(50 ct.)
No. 6617



Muzzleloading

Hornady continues to raise the bar for muzzleloading performance. Whether you shoot the technologically advanced Lock-N-Load® Speed Sabot® or the more traditional round ball or lead bullets, all Hornady muzzleloading products provide exceptional accuracy and the terminal performance that hunters continue to rely on season after season.

The manufacturing processes at Hornady ensure extreme precision, uniformity, and accuracy. Hunters everywhere are discovering that by using Hornady muzzleloading projectiles, centerfire accuracy can now be obtained from their muzzleloading rifles.

Complimenting the excellent Hornady line-up of muzzleloading bullets and sabots is an extensive line of muzzleloading accessories. Hornady produces accessories that will help muzzleloader hunters and shooters prepare for that one shot – perhaps THE shot that will put this season’s trophy on the wall and meat in the freezer.

The SST®-ML™ is an excellent choice for extended range blackpowder hunters.

Other “easy-load” bullets often fail to properly engage the rifling, which does not effectively stabilize the bullet and, as a result, accuracy suffers. But Hornady® sabots fully engage the rifling to keep the SST®-ML™ centered and sealed during firing, allowing for maximum velocity and unparalleled extended range performance. Upon impact, the Flex Tip® is compressed into the front of the bullet, causing the bullet to expand. The Speed Sabot® features a fumble-free method of pre-loading pellets.



SST®-ML™

SST®-ML™
SPEED SABOT®

At the heart of the MonoFlex® ML™ is the .452" diameter MonoFlex® bullet — a monolithic solid projectile made from a copper alloy and topped with the patented Flex Tip® design that works as a catalyst for uniform expansion, even at low velocities. The MonoFlex® won't separate and retains 95% of its original weight.

Specifically engineered to provide phenomenal accuracy, penetration and high weight retention, the MonoFlex® ML™ is a non-traditional/alternative metal construction bullet option that is a fantastic choice for ALL hunters.



MONOFLEX®
ML™

SST® ML™ LOW DRAG SABOT & SPEED SABOT®

CALIBER/TYPE	DIA	WEIGHT	B.C.	S.D.	ITEM NO.	COUNT
45 Cal. SST®-ML™	.400"	200 gr.	.265	.179	67132	20
50 Cal. SST®-ML™	.452"	250 gr.	.210	.175	67273	20
50 Cal. SST®-ML™	.452"	300 gr.	.250	.210	67263	20
50 Cal. Speed Sabot®	.452"	250 gr.	.210	.175	67270	10

See pages 149-157 for ballistics information.

MONOFLEX® ML™

CALIBER/TYPE	DIA	WEIGHT	B.C.	S.D.	ITEM NO.	COUNT
50 Cal. MonoFlex® ML™ High Speed/Low Drag Sabot*	.452"	250 gr.	.210	.175	67274	20

*California Compatible

See pages 149-157 for ballistics information.

U.S. Patent No. 8,413,587 & U.S. Patent No. 6,895,865



KEN HAAS



ERIC GUIDER



Effective in both traditional and modern muzzleloading rifles, these green sabot projectiles use the XTP® bullet which is specifically designed for deep penetration and proper expansion at all practical muzzleloading velocities.



XTP® MUZZLELOADING

CALIBER/TYPE	DIA	WEIGHT	B.C.	S.D.	ITEM NO.	COUNT
50 CAL XTP®	.430"	240 gr.	.205	.185	6720	20

See pages 149-157 for ballistics information.



BULLETS



Joyce Hornady recognized innovation as the product of a quest for perfection, and a belief that the next big breakthrough was just around the corner. Founded on the principle of making better shooting products, that desire has led to a wave of ingenuity ever since. Hornady® has become synonymous with success — in the field and on the firing line — in all conditions and environments. Letters and photos have poured in from every corner of the globe, detailing how an average hunt became a memory that will last forever thanks to Hornady® bullets. Our success depends upon your success, so please keep the stories coming. It's nice to know you're out there, putting Hornady® innovation to the test.





A-Tip™ Match

Years of research and testing by the Hornady® Ballistic Development Group, combined with advanced manufacturing processes and quality control measures have led to the creation of the ultimate low drag, high performance match bullet.

Use of a new A-TIP™ seating stem is required for optimal bullet seating.

TIP DESIGN

- Aluminum tip is precision machined and longer than polymer tips which moves the center of gravity and enhances in-flight stability.
- Aeroballistically advanced tip design results in tighter groups and reduced drag variability.
- Perfect blend of ogive, tip length, bearing surface and optimized boattail by caliber.

PERFORMANCE

- Doppler radar verified low drag coefficient (high BC) bullets are forgiving of twist rate, seating depth and muzzle velocity.
- Refined design of the AMP® bullet jacket offers industry leading uniformity and concentricity.

MANUFACTURING

- Right off the press – sequentially packaged, one clone after another for the ultimate in consistent performance.
- Minimal handling throughout the manufacturing process ensures consistency from bullet to bullet.
- Packaged with a polishing bag to prepare bullets for loading (bullets aren't bulk washed after manufacture).

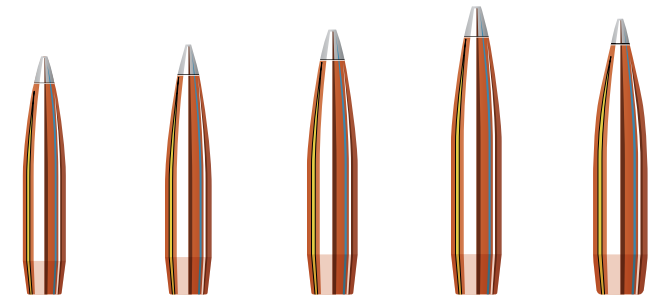

CALIBER/ TYPE	22 Cal. A-Tip™ Match	6mm A-Tip™ Match	6.5mm A-Tip™ Match	6.5mm A-Tip™ Match	7mm A-Tip™ Match
Diameter	.224"	.243"	.264"	.264"	.284"
Weight	90 gr.	110 gr.	135 gr.	153 gr.	166 gr.
G1 Ballistic Coef.	.585	.604	.637	.704	TBD
G7 Ballistic Coef.	.295	.304	.321	.355	—
Sec. Den.	.256	.266	.277	.314	.294
Item #	2286	24531	26179	2638	2836
Box Count	100	100	100	100	100



CLAY BLACKETTER
2019 Open Division Champion



CHARLES ROBERTS
2019 Tactical Division Champion



DOUG KOENIG
2019 Production Division Champion

A-TIP™ TAKES SHOOTERS TO THE TOP!

The A-Tip™ Match bullet has taken the competitive shooting world by storm like no other bullet before it! Right out of the box, it makes even the best shooters better. Consider these results from 2019:



- A-Tip™ bullets were used to win BOTH the Precision Rifle Series (PRS) Finale and the overall PRS year-long points race.
- A-Tip™ was the bullet of choice for winners of all three divisions at the finale: Open (Clay Blacketter), Tactical (308 Win — Charles Roberts) and Production (Doug Koenig).
- FOUR of the top FIVE competitors in the Open Division (the biggest and best division) at the PRS Finale shot A-Tip™ bullets.
- SIX of the top 10 Open Division shooters in the overall year-long points race shot A-Tip™, including the overall winner (Clay Blacketter).

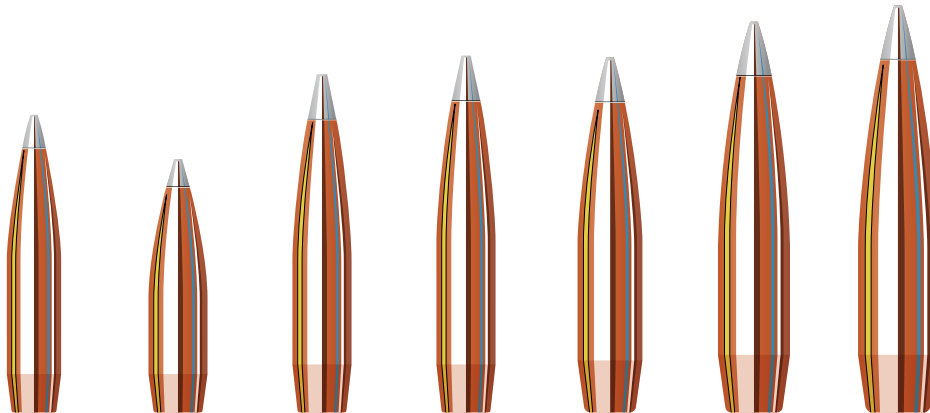

CALIBER/ TYPE	7mm A-Tip™ Match	30 Cal. A-Tip™ Match	30 Cal. A-Tip™ Match	30 Cal. A-Tip™ Match	338 Cal. A-Tip™ Match	375 Cal. A-Tip™ Match	416 Cal. A-Tip™ Match
Diameter	.284"	.308"	.308"	.308"	.338"	.375"	.416"
Weight	190 gr.	176 gr.	230 gr.	250 gr.	300 gr.	390 gr.	500 gr.
G1 Ballistic Coef.	TBD	.564	.823	.878	.863	.987	.976
G7 Ballistic Coef.	—	.284	.414	.442	.435	.497	.492
Sec. Den.	.337	.265	.346	.377	.375	.396	.413
Item #	28506	30717	3091	3092	33389	3729	41697
Box Count	100	100	100	100	100	25	25



ELD-X®

The ELD-X® (Extremely Low Drag - eXpanding) bullet is a technologically advanced, match accurate, ALL-RANGE hunting bullet featuring highest-in-class ballistic coefficients and consistent, controlled expansion at ALL practical hunting distances.

All manufacturers' conventional polymer tips in high BC bullets melt in flight. Hornady® engineers discovered that conventional bullet tip materials in streamlined, high BC bullets melt and deform. Although not a significant issue affecting moderate BC conventional tipped varmint and hunting bullets, aerodynamic heating causes BC reduction and degradation of accuracy, particularly at extended ranges (400 yds +). To counter this effect, Hornady® identified a heat resistant polymer and developed the Heat Shield® tip. This revolutionary new tip creates the perfect meplat (tip) with exceptionally consistent results from bullet-to-bullet and lot-to-lot.

At conventional range (0-400 yards), the ELD-X® bullet is designed to continually expand throughout its penetration path. Upon impact, the thin nose section of the bullet peels back and sheds material until it reaches the thick shank of the bullet jacket where the InterLock® ring works to keep the core and jacket together. The remaining heavy shank of the bullet continues to drive forward and expand for extremely lethal results.



BEST-IN-CLASS BCs

Verified by Doppler radar, the Heat Shield® tip is immune to the effects of aerodynamic heating and retains its shape to maintain the highest-in-class BC over its entire trajectory.

MATCH ACCURATE HUNTING BULLET

Streamlined secant ogive with optimum boattail design + highly concentric AMP® bullet jackets + Heat Shield® tip combine for radically superior aerodynamic efficiency.

DEVASTATING CONVENTIONAL RANGE PERFORMANCE

With high velocity 0-400 yard impact, the bullet continually expands throughout its penetration path. The thick shank of the jacket and high InterLock® ring keep the core and jacket together providing 50-60% weight retention.

BEST EXTENDED RANGE TERMINAL PERFORMANCE AVAILABLE

Upon low velocity 400+ yard impacts, the Heat Shield® tip drives backward into the bullet to initiate expansion. Exhibiting conventional expansion with a large mushroom and 85-90% retained weight the bullet provides deep penetration and large wound cavities.

IMPACT VELOCITIES:
30 Cal. 200 gr. ELD-X®



FEATURING
AMP
Advanced Manufacturing Process®
BULLET JACKETS



GORDON WHITTINGTON

CLINT POWELL



Custom-profiled seating stems available for ELD-X® bullets. See page 119.

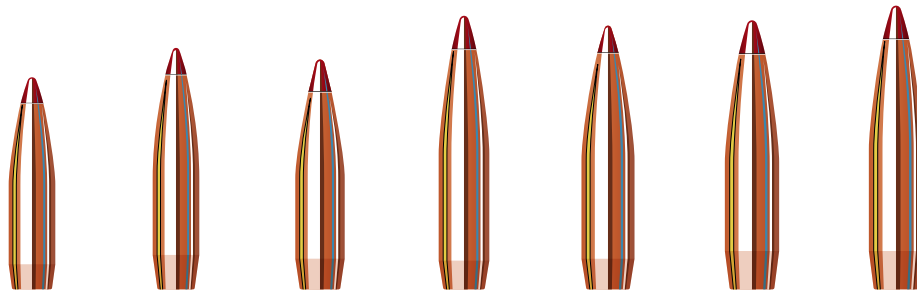

CALIBER/TYPE	6mm ELD-X®	6mm ELD-X®	25 Cal. ELD-X®	6.5mm ELD-X®	270 Cal. ELD-X®	7mm ELD-X®	7mm ELD-X®
Diameter	.243"	.243"	.257"	.264"	.277"	.284"	.284"
Weight	90 gr.	103 gr.*	110 gr.	143 gr.	145 gr.	150 gr.	162 gr.
G1 Ballistic Coef.	.409	.512	.465	.623	.536	.574	.631
G7 Ballistic Coef.	.206	.258	.234	.314	.270	.289	.318
Sec. Den.	.218	.249	.238	.293	.270	.266	.287
Item #	2441	24550	25418	2635	27356	2826	2840
Box Count	100	100	100	100	100	100	100

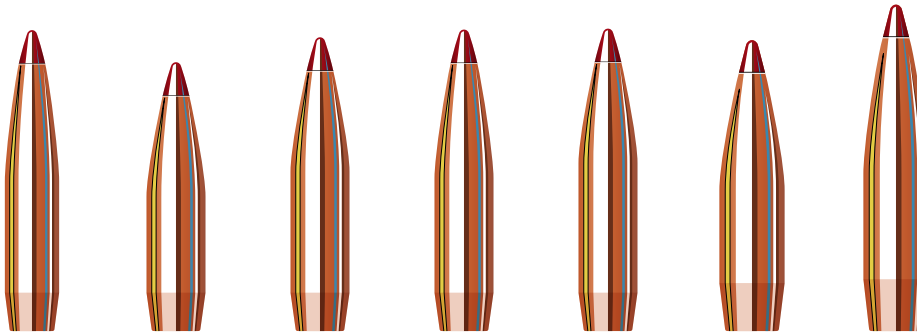

CALIBER/TYPE	7mm ELD-X®	30 Cal. ELD-X®	30 Cal. ELD-X®	30 Cal. ELD-X®	30 Cal. ELD-X®	338 Cal. ELD-X®	338 Cal. ELD-X®
Diameter	.284"	.308"	.308"	.308"	.308"	.338"	.338"
Weight	175 gr.*	178 gr.	200 gr.	212 gr.*	220 gr.	230 gr.	270 gr.
G1 Ballistic Coef.	.689	.552	.597	.663	.654	.616	.757
G7 Ballistic Coef.	.347	.278	.301	.334	.329	.310	.381
Sec. Den.	.310	.268	.301	.319	.331	.288	.338
Item #	2841	3074	3076	3077	3078	33210	33371
Box Count	100	100	100	100	100	100	50

GEORGE GARDNER



MARK CHENIER

*To achieve optimal performance, non-standard magazine length, chamber and faster twist rate barrel may be required.



ELD® Match

ELD® Match (Extremely Low Drag Match) bullets are technologically advanced, enhanced accuracy target bullets featuring Heat Shield® tips with the PERFECT MEPLAT (tip point) combined with numerous design features that deliver the highest-in-class ballistic coefficients, superior accuracy and extreme consistency from bullet-to-bullet, lot-to-lot.

All manufacturers' conventional polymer tips in high BC bullets melt in flight. During testing of what would become the ELD-X® hunting bullet, Hornady® engineers, using Doppler radar, discovered that conventional bullet tip materials were melting and deforming in flight, resulting in BC reduction and degradation of accuracy, particularly at extended ranges (400 yards +). To counter this effect, Hornady® identified a heat resistant polymer and developed the Heat Shield® tip that resists aerodynamic heating and creates the perfect meplat (tip). This revolutionary new tip technology led to the creation of the most advanced match bullets on the market — ELD® Match.

Superior accuracy and industry leading ballistic design has been achieved with the ELD® Match bullet. An optimum secant ogive and boattail design along with the Heat Shield® tip produce a bullet with the highest possible ballistic coefficient in its class. Verified by Doppler Radar, ELD® Match ballistic coefficients do not vary due to the integrity of the Heat Shield® tip. The bullets perform extraordinarily consistently with no BC degradation at extended range.

BEST-IN-CLASS BCs

The Heat Shield® tip is immune to the effects of aerodynamic heating and retains its shape to provide a perfect meplat (tip) that is always the same shape.

DELIVERS THE HIGHEST DEGREE OF ACCURACY AND BULLET-TO-BULLET/LOT-TO-LOT CONSISTENCY

Streamlined secant ogive with optimum boattail design + highly concentric AMP® bullet jackets + Heat Shield® tip creates a supremely accurate, high BC match bullet.

ACCURATE, DOPPLER RADAR VERIFIED BCs

ELD® Match bullet BCs are measured with Doppler radar and corrected to standard atmospheric conditions.



Hornady engineers used Doppler radar to discover the effects of aerodynamic heating and confirm the effectiveness of the Heat Shield® tip.



FEATURING
AMP
Advanced Manufacturing Process®
BULLET JACKETS



THE PERFECT TIP!
The new Heat Shield® tip creates the perfect meplat and outperforms BTHP bullets.

Custom-profiled seating stems available for ELD® Match bullets. See page 119.

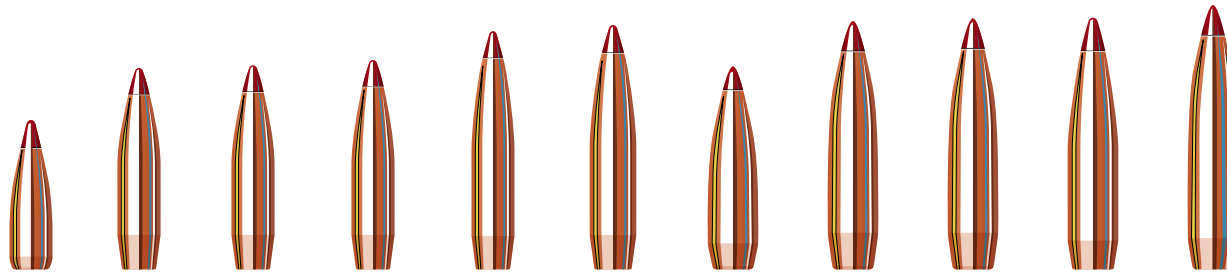

CALIBER/TYPE	22 Cal. ELD® Match	22 Cal. ELD® Match	22 Cal. ELD® Match	22 Cal. ELD® Match	22 Cal. ELD® Match	6mm ELD® Match	6.5mm ELD® Match	6.5mm ELD® Match	6.5mm ELD® Match	6.5mm ELD® Match	6.5mm ELD® Match
Diameter	.224"	.224"	.224"	.224"	.224"	.243"	.264"	.264"	.264"	.264"	.264"
Weight	52 gr.	73 gr.	75 gr.*	80 gr.*	88 gr.*	108 gr.*	100 gr.	120 gr.	123 gr.	130 gr.	140 gr.
G1 Ballistic Coef.	.247	.398	.467	.485	.545	.536	.385	.486	.506	.554	.646
G7 Ballistic Coef.	—	.200	.235	.244	.274	.270	.194	.245	.255	.279	.326
Sec. Den.	.148	.208	.214	.228	.251	.261	.205	.246	.252	.266	.287
Item #	22491	22774	22791/22791B	22831	22834/22834B	24561/24561B	26100	26175	26176	26177	26331/26331B
Box Count	100	100	100/3500	100	100/3500	100/2700	100	100	100	100	100/2000

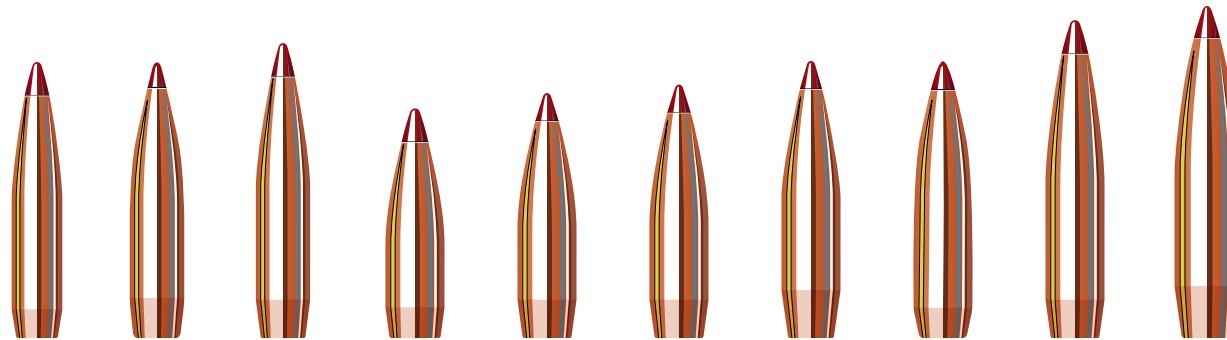

CALIBER/TYPE	6.5mm ELD® Match	7mm ELD® Match	7mm ELD® Match	30 Cal. ELD® Match	30 Cal. ELD® Match	30 Cal. ELD® Match	30 Cal. ELD® Match	30 Cal. ELD® Match	30 Cal. ELD® Match	30 Cal. ELD® Match	338 Cal. ELD® Match
Diameter	.264"	.284"	.284"	.308"	.308"	.308"	.308"	.308"	.308"	.308"	.338"
Weight	147 gr.	162 gr.	180 gr.*	155 gr.	168 gr.	178 gr.	195 gr.	208 gr.	225 gr.*	285 gr.	
G1 Ballistic Coef.	.697	.670	.777	.461	.523	.547	.584	.690	.777	.829	
G7 Ballistic Coef.	.351	.338	.391	.232	.263	.275	.294	.348	.391	.417	
Sec. Den.	.301	.287	.319	.233	.253	.268	.294	.313	.339	.356	
Item #	26333/26333B	28403	28503	30313	30506/30506B	30713	30951	30731	30904	33381	
Box Count	100/2000	100	100	100	100/1900	100	100	100	100	50	

Ten bullets through one hole

"Ten bullets through one hole" was the philosophy of Joyce Hornady, the company's founder. This great idea of accuracy and perfection has continued from the first bullet made more than 60 years ago, right through today. Shown is a quality control group that was shot from an 8-twist Bartlein barrel during our normal production process using a 6.5 Creedmoor 140 gr. ELD® Match bullet at **200 yds.** This target exemplifies J.W. Hornady's ideal in accuracy and consistent performance.

FREE DOWNLOAD
Hornady Ballistic App
with 4DOF®

*To achieve optimal performance, non-standard magazine length, chamber and faster twist rate barrel may be required.



Match™

All Hornady® Match™ and A-MAX® bullets now feature revolutionary AMP® (Advanced Manufacturing Process) bullet jackets. Developed by Hornady® engineers, these bullet jackets are a technological advancement in design, tooling, and manufacturing that combine to produce the most consistently concentric bullet jackets available. These proven AMP® jackets are the foundation for exceptional bullet accuracy and have virtually zero runout and near zero wall thickness variation. Coupled with precision swaged cores and manufactured to the tightest standards in the industry, all Hornady® Match™ and A-MAX® bullets provide superior consistency, high ballistic coefficients and unprecedented levels of accuracy.

SECANT OGIVE PROFILE

The geometric profile works to produce low drag and flatter trajectories. The secant ogive design also provides optimum bearing surface for stability in flight and the best ballistic coefficient possible.

SWAGED LEAD CORE

The swaging process provides excellent uniformity and balance for consistent performance and accuracy.

AMP® JACKET

The jacket has virtually zero runout and near zero wall thickness variation.



BOATTAIL

The angle and length of the boattail is unique and optimized for each caliber and weight of Match™ and A-MAX® bullet to maximize ballistic coefficient and performance.



CALIBER/ TYPE	22 Cal. BTHP Match™	22 Cal. BTHP Match™ W/C	22 Cal. HP Match™	22 Cal. HP Match™ W/C	22 Cal. BTHP Match™	22 Cal. BTHP Match™ W/C	22 Cal. BTHP Match™
Diameter	.224"	.224"	.224"	.224"	.224"	.224"	.224"
Weight	52 gr.	52 gr.	53 gr.	55 gr.	68 gr.	68 gr.	75 gr.
G1 Ballistic Coef.	.229	.229	.218	.254	.355	.355	.395
Sec. Den.	.148	.148	.151	.157	.194	.194	.214
Item #	2249/2249B	2249C	2250/2250B	2263B	2278/22785/2278B	2278C	2279/22796/2279B
Box Count	100/6000	6000	100/6000	6000	100/500/4500	4500	100/600/4000

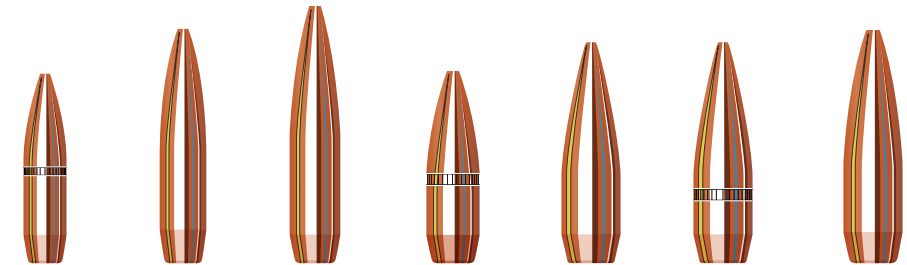

CALIBER/ TYPE	22 Cal. BTHP Match™ W/C	6mm BTHP Match™	6.5mm BTHP Match™	6.8mm/270 Cal. BTHP W/C	30 Cal. BTHP Match™	30 Cal. BTHP Match™ W/C	30 Cal. BTHP Match™
Diameter	.224"	.243"	.264"	.277"	.308"	.308"	.308"
Weight	75 gr.	105 gr.	140 gr.	110 gr.	155 gr.	155 gr.	168 gr.
G1 Ballistic Coef.	.395	.530	.580	.360	.405	.405	.450
Sec. Den.	.214	.254	.287	.205	.233	.233	.253
Item #	2279C	2458/24585	26335	27200	3039/3039B	3039C	30501/305016/30501B
Box Count	4000	100/500	100	100	100/2000	2000	100/250/1800

Ten shot groups
at 200 yards



 **FREE DOWNLOAD**
Hornady Ballistic App
with 4DOF®

Custom-profiled
seating stems available.
See page 119.

A-MAX®



POLYMER TIP

The uniform point raises the ballistic coefficient and precisely balances the center of pressure relative to the center of gravity in order to achieve optimal in-flight stability.

SECANT OGIVE PROFILE

The geometric profile works to produce low drag and flatter trajectories. The secant ogive design also provides the optimum bearing surface for stability in flight and the best ballistic coefficient possible.

SWAGED LEAD CORE

The swaging process provides excellent uniformity and balance for consistent performance and accuracy.

AMP® JACKET

The jacket has virtually zero tolerance for concentricity and near zero wall thickness variation.



BOATTAIL

The angle and length of the boattail is unique to each caliber and weight of Match™ and A-MAX® bullets to maximize ballistic coefficient and accuracy.

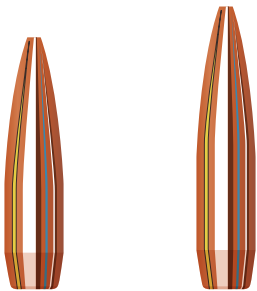

CALIBER/ TYPE	30 Cal. BTHP Match™	30 Cal. BTHP Match™
Diameter	.308"	.308"
Weight	178 gr.	208 gr.
G1 Ballistic Coef.	.530	.620
Sec. Den.	.268	.313
Item #	30715/30715B	30733
Box Count	100/1600	100

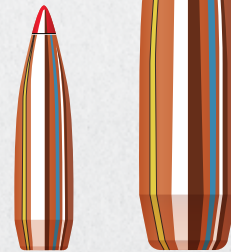

CALIBER/ TYPE	30 Cal. A-MAX®	50 Cal. A-MAX®
Diameter	.308"	.510"
Weight	168 gr.	750 gr.
G1 Ballistic Coef.	.475	1.050
Sec. Den.	.253	.412
Item #	30502	5165
Box Count	100	20





Sub-X[®]

Sub-X[®] (Subsonic — eXpanding) bullets deliver big results without a big bang! Designed to provide deep penetration below the speed of sound, Sub-X[®] features a lead core. Long serrations in the gilding metal jacket combine with the patented Flex Tip[®] insert within the bullet's hollowpoint cavity to help it expand reliably at low velocities. Cannelures provide positive case crimp, making Sub-X[®] ideal for semiautomatic weapons.

EXPANDS AT SUBSONIC VELOCITIES

Patented Flex Tip[®] technology aids in expansion at velocities as low as 900 fps.

POSITIVE CASE CRIMP

Lead core bullet with cannellured jacket provides positive case crimp for use in semiautomatics.

FUNCTIONS EFFECTIVELY IN A WIDE RANGE OF GUNS

Designed to fit, feed and function in a variety of firearms, including gas system guns.



300 BLACKOUT 190 GR. BARE GELATIN

Velocity: 1050 fps | Total Penetration: 17.5"



KYLE FIEST



CALIBER/TYPE	30 Cal. Sub-X [®]
Diameter	.308"
Weight	190 gr.
G1 Ballistic Coef.	.437
Sec. Den.	.286
Item #	30730
Box Count	100



MonoFlex®

IMPACT VELOCITIES: 30 cal. 140 gr. MonoFlex®



CODY BUTLER



GARY LASSEN

By combining the technologies of the GMX® and FTX® bullet design, the MonoFlex® bullet gives lever gun shooters another option. Constructed of a copper alloy, MonoFlex® bullets offer hunters a solid bullet that won't separate, and when recovered, retains 95% of its original weight. Copper alloy differs from solid copper in that it is harder, tougher and does not foul or increase pressure the way solid copper bullets do.

Upon impact, the patented Flex Tip® design initiates immediate expansion, even at the lower velocities often encountered in mid to long range lever gun shooting situations. Its deep penetration and high weight retention combine to produce yet another accurate, deadly and dependable choice for lever gun hunters.

PATENTED FLEX TIP® DESIGN

Safe to use in all tubular magazines and initiates expansion, even at lower velocities.

COPPER ALLOY CONSTRUCTION

One-piece copper alloy won't separate and delivers devastating terminal performance, deep penetration and 95% weight retention.

BALLISTICALLY EFFICIENT SECANT OGIVE PROFILE

Delivers the flattest possible trajectories from lever guns.

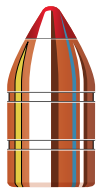
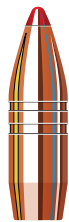
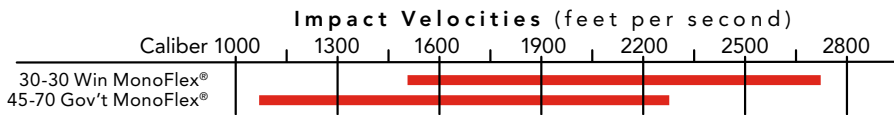

CALIBER/ TYPE	30 Cal. MonoFlex® (30-30 Win)	45 Cal. MonoFlex® (45-70 Govt)
Diameter	.308"	.458"
Weight	140 gr.	250 gr.
Ballistic Coef.	.277	.175
Sec. Den.	.211	.170
Item #	30310	45010
Box Count	50	50





GMX[®]

Hard-hitting and deep-penetrating, the GMX[®] bullet combines monolithic construction with pioneering ballistic design to meet the need for a premium, non-traditional bullet. Tougher than pure copper, the mono-metal copper alloy has been proven to shoot cleaner, foul less, and deliver consistent and even pressure curves. The tough alloy material routinely retains 95% or more of its original weight and expands up to 1.5 times its original diameter.

Featuring a long, sleek profile with cannelures, the design reduces overall bearing surface and friction in-bore, while achieving some of the highest ballistic coefficients from monolithic, non-traditional bullets. Initiating expansion upon impact, the hard polymer tip drives into the hollow cavity at the front of the bullet, creating a mushroom-style projectile as it travels through the animal. Fully California compatible and appropriate for use in areas requiring the use of non-traditional bullets, GMX[®] is ideal for any sized game, from antelope to moose.



COPPER ALLOY CONSTRUCTION

One-piece copper alloy won't separate and delivers devastating terminal performance, deep penetration, and 95% weight retention.

CRIMPING CANNELURE AND PRESSURE RELIEVING GROOVES

Reduces both bearing surface and fouling, and aids in consistent reloads.

HIGH WEIGHT-RETENTION

High weight retention is a significant benefit to the GMX[®] and monolithic family of bullets, routinely retaining 95% or more of their original weight.

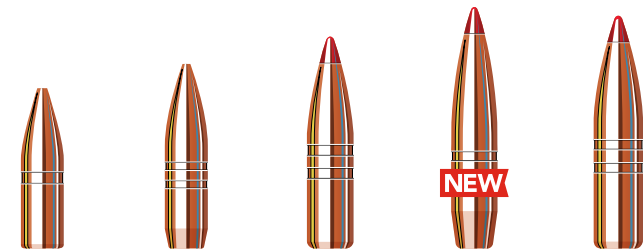

CALIBER/TYPE	22 Cal. GMX [®]	22 Cal. GMX [®]	6mm GMX [®]	6mm GMX [®] (6mm Creedmoor)	25 Cal. GMX [®]
Diameter	.224"	.224"	.243"	.243"	.257"
Weight	55 gr.	70 gr.	80 gr.	90 gr.*	90 gr.
Ballistic Coef.	.245	.350	.300	.422	.290
Sec. Den.	.157	.199	.194	.218	.195
Item #	22273	2281	24370	2444	25410
Box Count	50	50	50	50	50

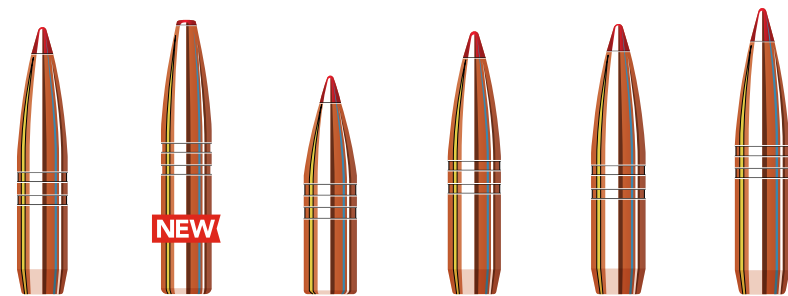

CALIBER/TYPE	6.5mm GMX [®]	6.5mm GMX [®]	6.8mm/270 Cal. GMX [®]	270 Cal. GMX [®]	7mm GMX [®]	7mm GMX [®]
Diameter	.264"	.264"	.277"	.277"	.284"	.284"
Weight	120 gr.	140 gr.*	100 gr.	130 gr.	139 gr.	150 gr.
Ballistic Coef.	.450	.350	.310	.460	.486	.464
Sec. Den.	.246	.287	.186	.242	.246	.266
Item #	26110	26336	27190	27370	28270	2828
Box Count	50	50	50	50	50	50

*Requires 1:8" or faster twist rate.



**IMPACT VELOCITIES:
30 Cal. 150 gr. GMX®**

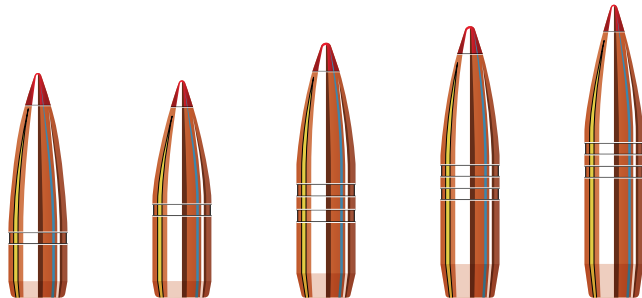

CALIBER/ TYPE	30 Cal. GMX®	30 Cal. GMX®	30 Cal. GMX®	30 Cal. GMX®	30 Cal. GMX®
Diameter	.308"	.308"	.308"	.308"	.308"
Weight	110 gr.	125 gr.	150 gr.	165 gr.	180 gr.
Ballistic Coef.	.305	.295	.415	.447	.485
Sec. Den.	.166	.188	.226	.248	.271
Item #	30191	30190	30370	30470	30193
Box Count	50	50	50	50	50



CALIBER/ TYPE	8mm GMX®	338 Cal. GMX®	338 Cal. GMX®	9.3mm GMX®	375 Cal. GMX®
Diameter	.323"	.338"	.338"	.366"	.375"
Weight	180 gr.	185 gr.	225 gr.	250 gr.	250 gr.
Ballistic Coef.	.420	.420	.470	.360	.430
Sec. Den.	.246	.231	.281	.267	.254
Item #	3234	33270	33201	3562	3708
Box Count	50	50	50	50	50

RENAE WALTEMATH



ABBY HORNADY



InterBond®

The Hornady® InterBond® bullet uses a proprietary bonding process that holds the core and jacket together. Unlike partitioned or dual-core bullets, where the front core can separate from the bullet mass, the InterBond® bullet holds together in a single destructive mass that delivers a deep, wide wound channel without over-penetrating.

The bonding process, along with a thicker, stiffer jacket, allows InterBond® bullets to retain more than 90% of their mass, even through tough hide and bones. Plus, they immediately expand to more than twice their diameter for maximum energy transfer.

POLYMER TIP

The sleek polymer tip improves ballistic performance, accuracy and initiation of expansion.

BONDED CORE

The bonded design ensures that the bullet achieves controlled expansion with virtually no fragmentation and the core will never separate from the jacket.

THICK, TOUGH JACKET

Necessary to retain weight and contributes to expansion of over twice the bullet diameter.



IMPACT VELOCITIES: 30 cal. 150 gr. InterBond®

2910 fps
Retained 135 gr.
90% Wt. Ret.
.765" Expanded



2686 fps
Retained 137 gr.
91.3% Wt. Ret.
.717" Expanded



2473 fps
Retained 141 gr.
94% Wt. Ret.
.692" Expanded

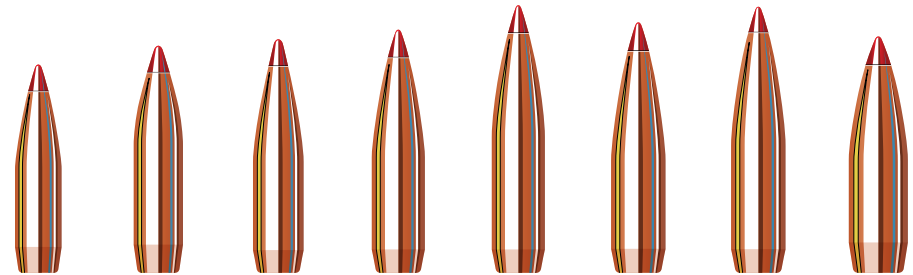

CALIBER/ TYPE	6mm InterBond®	25 Cal. InterBond®	6.5mm InterBond®	270 Cal. InterBond®	270 Cal. InterBond®	7mm InterBond®	7mm InterBond®	30 Cal. InterBond®
Diameter	.243"	.257"	.264"	.277"	.277"	.284"	.284"	.308"
Weight	85 gr.	110 gr.	129 gr.	130 gr.	150 gr.	139 gr.	154 gr.	150 gr.
Ballistic Coef.	.395	.390	.485	.460	.525	.486	.525	.415
Sec. Den.	.206	.238	.264	.242	.279	.246	.273	.226
Item #	24539	25419	26209	27309	27409	28209	28309	30309
Box Count	100	100	100	100	100	100	100	100

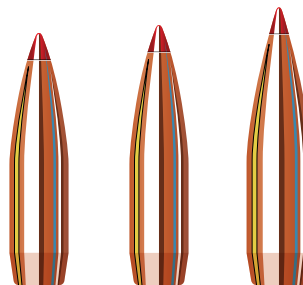

CALIBER/ TYPE	30 Cal. InterBond®	30 Cal. InterBond®	338 Cal. InterBond®
Diameter	.308"	.308"	.338"
Weight	165 gr.	180 gr.	225 gr.
Ballistic Coef.	.447	.480	.515
Sec. Den.	.248	.271	.281
Item #	30459	30709	33209
Box Count	100	100	100



JOSEPH VON BENEDIKT

**IMPACT VELOCITIES:
30 Cal. 165 gr. SST®**

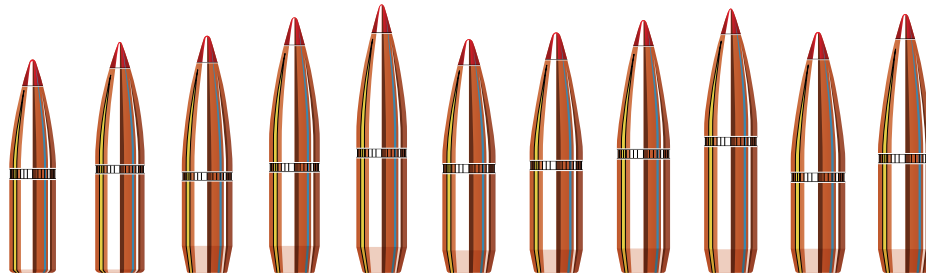
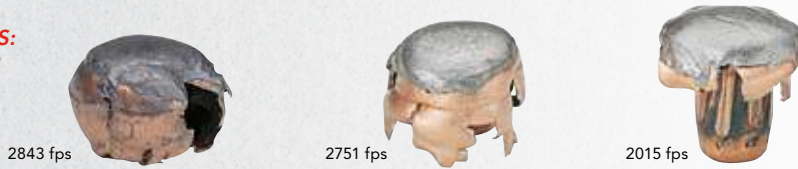

CALIBER/ TYPE	6mm SST®	25 Cal. SST®	6.5mm SST®	6.5mm SST®	6.5mm SST®	6.8mm/270 Cal. SST®	270 Cal. SST®	270 Cal. SST®	270 Cal. SST®	7mm SST®	7mm SST®
Diameter	.243"	.257"	.264"	.264"	.264"	.277"	.277"	.277"	.277"	.284"	.284"
Weight	95 gr.	117 gr.	123 gr.	129 gr.	140 gr.	120 gr.	130 gr.	140 gr.	150 gr.	139 gr.	154 gr.
Ballistic Coef.	.355	.390	.510	.485	.520	.400	.460	.495	.525	.486	.525
Sec. Den.	.230	.253	.252	.264	.287	.223	.242	.261	.279	.246	.273
Item #	24532	25522	26173	26202	26302	2716	27302	27352	27402	28202	28302
Box Count	100	100	100	100	100	100	100	100	100	100	100

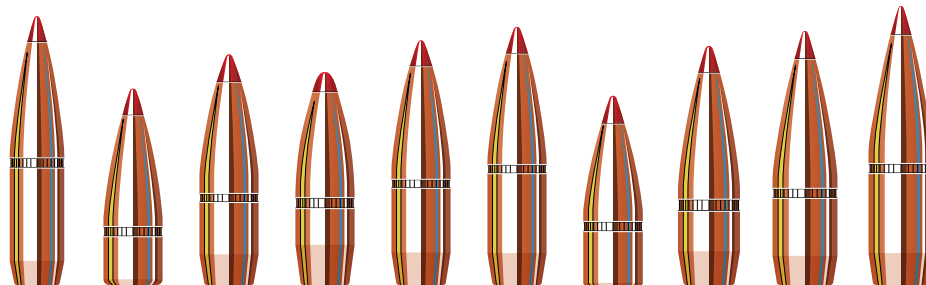

CALIBER/ TYPE	7mm SST®	30 Cal. SST®	30 Cal. SST®	30 Cal. SST® (300 Savage)	30 Cal. SST®	30 Cal. SST®	7.62 x 39 mm SST®	8mm SST®	338 Cal. SST®	338 Cal. SST®
Diameter	.284"	.308"	.308"	.308"	.308"	.308"	.310"	.323"	.338"	.338"
Weight	162 gr.	125 gr.	150 gr.	150 gr.	165 gr.	180 gr.	123 gr.	170 gr.	200 gr.	225 gr.
Ballistic Coef.	.550	.305	.415	.370	.447	.480	.295	.445	.455	.515
Sec. Den.	.287	.188	.226	.226	.248	.271	.183	.233	.250	.281
Item #	28452	3019	30302	30303	30452	30702	3142	3233	33102	33202
Box Count	100	100	100	100	100	100	100	100	100	100

Short for "Super Shock Tip,"™ the Hornady® SST® is designed to deliver tremendous shock on impact while expanding quickly and reliably, particularly at higher velocities. Flat shooting and deadly accurate, it's an ideal bullet for whitetails, as well as most North American game animals from antelope to moose and similar-sized African plains game. The SST® creates a devastatingly large wound channel.

POLYMER TIP

The sleek polymer tip increases the ballistic coefficient, making it more efficient. Upon impact, the tip also initiates controlled expansion.

SECANT OGIVE, BOATTAIL PROFILE

It's a fact, bullets that travel faster hit harder. The Hornady® secant ogive gives hunters the speed, ballistic efficiency and downrange energy they're looking for.

CANNELURE

Provides a consistent crimp location, and also works with the InterLock® ring to control expansion.

INTERLOCK® RING

Ensures the core and jacket remain locked solid during expansion, so the SST® retains the mass and energy needed for dramatic wound channels.





FTX® Rifle

Hornady® FTX® bullets revolutionized lever gun ballistics, creating a new level of performance for these popular firearms. Lever gun enthusiasts can now harness the accuracy, power, and long-range performance of a tipped bullet that's safe to load in tubular magazines.

The patented Flex Tip®, combined with its secant ogive design, creates an aerodynamic bullet with a thinner, tapered front section and extended bearing surface for much higher ballistic coefficients. The FTX® flies faster and flatter than traditional lever gun bullets, resulting in improved accuracy at ranges well beyond what was historically common.

The high antimony lead core is locked to the jacket with an InterLock® ring, resulting in reliable performance and deep penetration on large or heavy-bodied game animals. Designed to perform at muzzle velocities from 1,600 to 2,600 fps, FTX® bullets give lever guns new life!

PATENTED FLEX TIP® BULLET TECHNOLOGY

Upon impact, the soft tip compresses into the bullet, initiating immediate expansion across a wide range of velocities. Safe to shoot in tubular magazines as well as any other firearm.

INTERLOCK® RING

Mechanically locks the core and jacket together for maximum weight retention and deep penetration.

BALLISTICALLY EFFICIENT SECANT OGIVE

Pioneered by Hornady®, the secant ogive profile delivers stability, flat trajectories and amazing accuracy.

SPECIALY ENGINEERED JACKET

The heavy jacket over the shank of the bullet combined with our proven InterLock® design controls expansion and enhances accuracy.



IMPACT VELOCITIES:



**30-30 cal.
160 gr.**
2250 fps
75% Wt. Ret.
.550" Expanded

**338 Marlin
200 gr.**
2450 fps
72% Wt. Ret.
.625" Expanded

**44 cal.
225 gr.**
1650 fps
82% Wt. Ret.
.610" Expanded

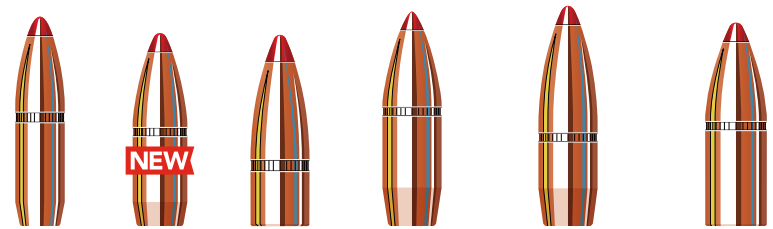

CALIBER/ TYPE	25 Cal. FTX®	7mm FTX®	30 Cal. FTX®	30 Cal. FTX® (30-30 Win)	30 Cal. FTX® (308 Marlin Express)	32 Cal. FTX® (32 Win)
Diameter	.257"	.284"	.308"	.308"	.308"	.321"
Weight	110 gr.	120 gr.	135 gr.	160 gr.	160 gr.	165 gr.
Ballistic Coef.	.340	.320	.274	.330	.395	.310
Sec. Den.	.238	.213	.203	.241	.241	.229
Item #	2542	2812	3027	30395	30396	32005
Box Count	100	100	100	100	100	100

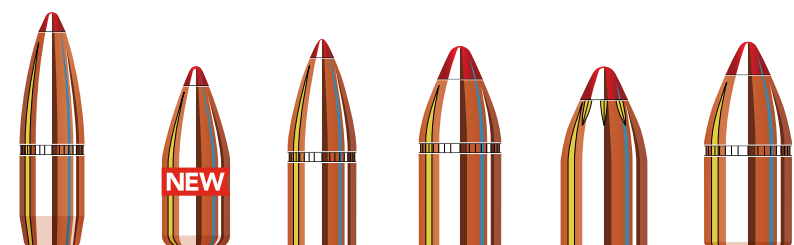

CALIBER/ TYPE	338 Cal. FTX® (338 Marlin Express)	35 Cal. FTX® (350 Legend)	35 Cal. FTX®	44 Cal. FTX® (444 Marlin)	45 Cal. FTX® (450 Bushmaster)	45 Cal. FTX® (45-70)
Diameter	.338"	.355"	.358"	.430"	.452"	.458"
Weight	200 gr.	165 gr.	200 gr.	265 gr.	250 gr.	325 gr.
Ballistic Coef.	.430	.250	.300	.225	.210	.230
Sec. Den.	.250	.193	.223	.205	.175	.221
Item #	33104	3502	35105	4305	45201	45015
Box Count	100	100	100	50	50	50

FTX® Handgun



IMPACT VELOCITIES:

357 cal. 140 gr.
1500 fps
83% Wt. Ret.
.550" Expanded



44 cal. 225 gr.
1450 fps
85% Wt. Ret.
.625" Expanded



Hornady® offers the same Flex Tip® technology for handguns that revolutionized lever guns. Typical hollow point bullets deliver good performance at modest velocities, but have a tendency to expand too quickly and sacrifice penetration at the higher velocities achieved with lever action guns.

Hornady® FTX® bullets achieve reliable expansion over a wide range of velocities. Upon impact, the patented FTX® tip is compressed into the front of the bullet, causing the bullet to expand and transfer immediate energy for a devastating temporary cavity — even at low velocity.

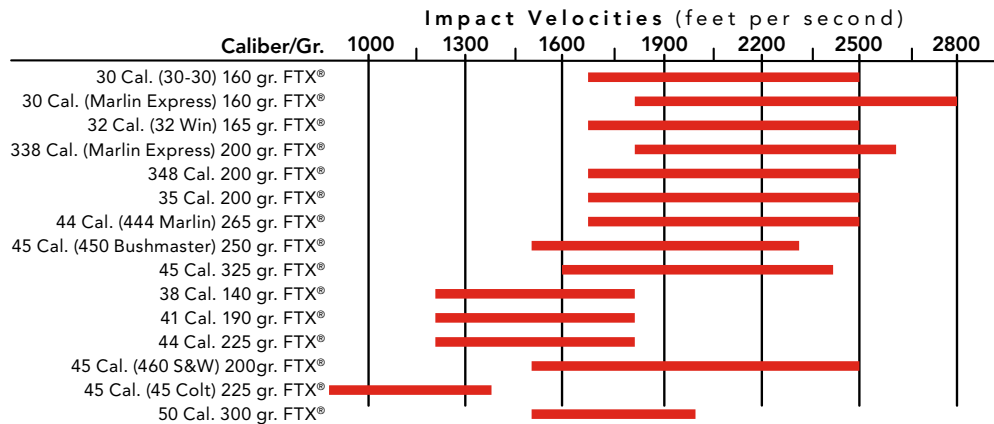

PATENTED FLEX TIP® BULLET TECHNOLOGY

Upon impact, the soft tip compresses into the bullet, initiating immediate expansion across a wide range of velocities. Safe to shoot in tubular magazines as well as any other firearm.

INTERLOCK® RING

Mechanically locks the core and jacket together for maximum weight retention and deep penetration.

BALLISTICALLY EFFICIENT SECANT OGIVE

Pioneered by Hornady®, the secant ogive profile delivers stability, flat trajectories and amazing accuracy.

SPECIALLY ENGINEERED JACKET

The heavy jacket over the shank of the bullet combined with our proven InterLock® design controls expansion and enhances accuracy.

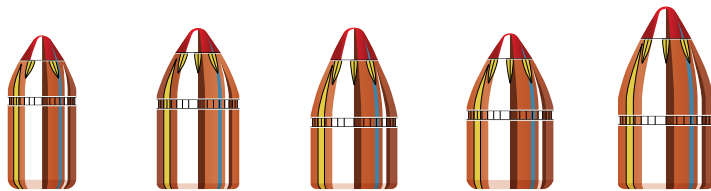
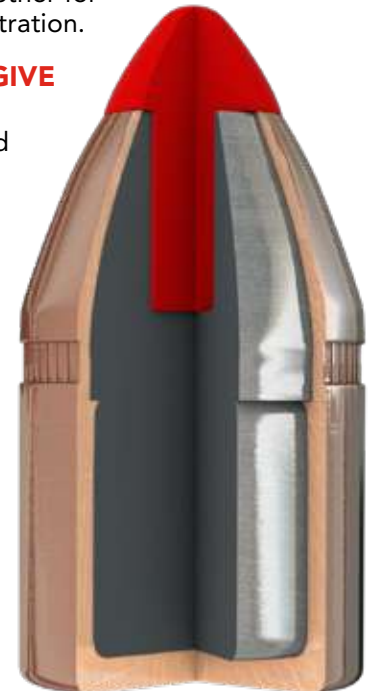

CALIBER/TYPE	38 Cal. FTX®	44 Cal. FTX®	45 Cal. FTX® (460 S&W Mag)	45 Cal. FTX® (45 Colt)	50 Cal. FTX® (500 S&W Mag)
Diameter	.357"	.430"	.452"	.452"	.500"
Weight	140 gr.	225 gr.	200 gr.	225 gr.	300 gr.
Ballistic Coef.	.160	.150	.145	.140	.200
Sec. Den.	.157	.174	.149	.157	.171
Item #	35745	44105	45215	45218	50102
Box Count	100	100	50	100	50



U.S. Patent No. 8,413,587

H V-MAX®

The dramatic fragmentation of the V-MAX® bullet comes from a combination of the gilding metal jacket, specially designed core and polymer tip.

The industry's leading varmint bullet with polymer tip and streamlined design results in flat trajectories. The concentricity of the match grade jacket design provides maximum accuracy at all ranges as well as explosive expansion, even at velocities as low as 1600 fps.

V-MAX® bullets are also available in factory-loaded Varmint Express® and Superformance® Varmint™ ammo.

POLYMER TIP

The polymer tip increases the ballistic coefficient and also initiates dramatic expansion upon impact – even at velocities as low as 1600 fps.

HIGHER BALLISTIC COEFFICIENT

Hornady® combines the sharp, pointed polymer tip with the most aerodynamic profile for a high ballistic coefficient. The V-MAX® profile also provides the maximum bearing surface for added in-flight stability.

SWAGED LEAD CORE

The swaging process allows for precise formation of the core up and around the tip, with a cavity under the tip's stem. This allows the tip to build up energy before smashing into the core, causing dramatic fragmentation of the core and jacket.

PRECISE BOATTAIL & FLATBASE DESIGNS

Utilizing the proper base design provides incredible in-flight stability for long-range shooting.

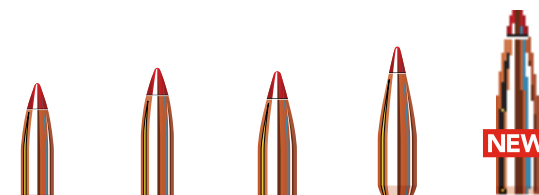

CALIBER/TYPE	17 Cal. V-MAX®	17 Cal. V-MAX®	20 Cal. V-MAX®	20 Cal. V-MAX®	5.45 Cal. V-MAX®
Diameter	.172"	.172"	.204"	.204"	.222"
Weight	20 gr.	25 gr.	32 gr.	40 gr.	60 gr.
Ballistic Coef.	.185	.230	.210	.275	.285
Sec. Den.	.097	.121	.110	.137	.175
Item #	21710	17105	22004	22006/22606	2207
Box Count	100	100	100	100/250	100

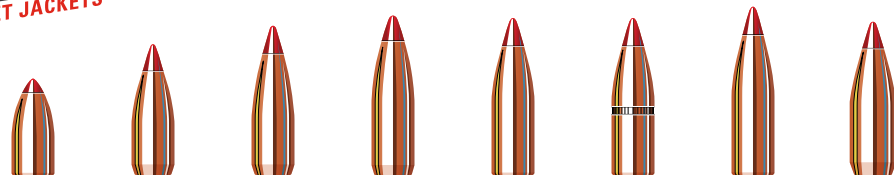

CALIBER/TYPE	22 Cal. V-MAX®	22 Cal. V-MAX®	22 Cal. V-MAX®	22 Cal. V-MAX®	22 Cal. V-MAX®	22 Cal. V-MAX® W/C	22 Cal. V-MAX®	6mm V-MAX®
Diameter	.224"	.224"	.224"	.224"	.224"	.224"	.224"	.243"
Weight	35 gr.	40 gr.	50 gr.	53 gr.	55 gr.	55 gr.	60 gr.	58 gr.
Ballistic Coef.	.109	.200	.242	.290	.255	.255	.265	.250
Sec. Den.	.100	.114	.142	.151	.157	.157	.171	.140
Item #	22252	22241/22416	22261/22616	22265	22271/22716	22272	22281	22411
Box Count	100	100/250	100/250	100	100/250	100	100	100

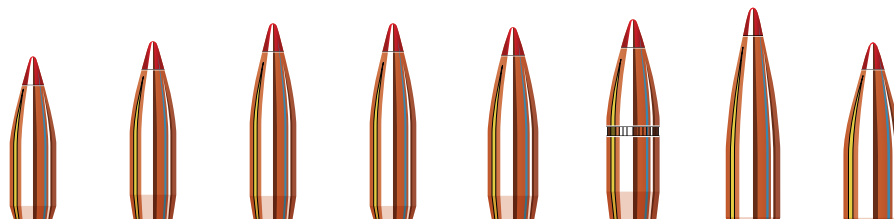

CALIBER/TYPE	6mm V-MAX®	6mm V-MAX®	6mm V-MAX®	25 Cal. V-MAX®	6.5mm V-MAX®	6.8mm/270 Cal. V-MAX® W/C	7mm V-MAX®	30 Cal. V-MAX®
Diameter	.243"	.243"	.243"	.257"	.264"	.277"	.284"	.308"
Weight	65 gr.	75 gr.	87 gr.	75 gr.	95 gr.	110 gr.	120 gr.	110 gr.
Ballistic Coef.	.280	.330	.400	.290	.365	.370	.365	.290
Sec. Den.	.157	.181	.210	.162	.195	.205	.213	.166
Item #	22415	22420	22440	22520	22601	22721	22810	23010
Box Count	100	100	100	100	100	100	100	100

Traditional Varmint™

The Hornady® line of traditional Varmint™ bullets features a streamlined design for flat trajectory. Its lead core and match-grade jacket represent the original standard created by Joyce Hornady for classic varmint hunting. Primarily comprised of spire point profiles and flat base designs, the bullets perform extremely well even at low velocities and deliver excellent performance in many classic varmint rifles.

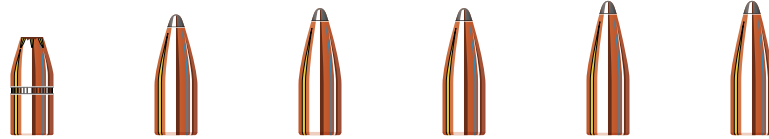

CALIBER/TYPE	22 Cal. HP BEE	22 Cal. HORNET	22 Cal. SP SX™	22 Cal. SP	22 Cal. SP SX™	22 Cal. SP
Diameter	.224"	.224"	.224"	.224"	.224"	.224"
Weight	45 gr.	45 gr.	50 gr.	50 gr.	55 gr.	55 gr.
Ballistic Coef.	.108	.202	.214	.214	.235	.235
Sec. Den.	.128	.128	.142	.142	.157	.157
Item #	2229	2230	2240	2245	2260	2265
Box Count	100	100	100	100	100	100

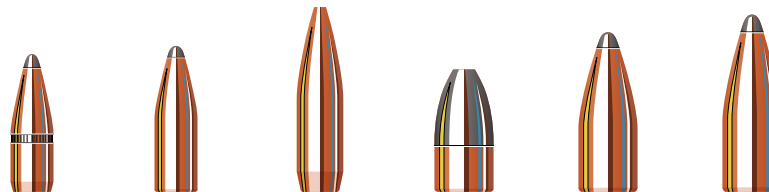

CALIBER/TYPE	22 Cal. SP W/C	22 Cal. SP	6mm BTHP	30 Cal. Short Jacket	30 Cal. SP	30 Cal. SP
Diameter	.224"	.224"	.243"	.308"	.308"	.308"
Weight	55 gr.	60 gr.	87 gr.	100 gr.	110 gr.	130 gr.
Ballistic Coef.	.235	.264	.376	.152	.256	.295
Sec. Den.	.157	.171	.210	.151	.166	.196
Item #	2266	2270	2442	3005	3010	3020
Box Count	100	100	100	100	100	100

NTX®



Hornady® NTX® bullets provide peerless performance with a non-traditional core material that combines accuracy, reliability and Hornady® quality for use in areas with restrictions on the use of traditional bullets.

Hornady® has made lead core bullets since 1949. Lead is, and always will be an excellent core material that provides density and hard-hitting energy to a vast array of bullets. However, there are regulations in some areas that restrict the use of lead in bullets. The NTX® is a phenomenal choice when a non-lead bullet is required.



FEATURING
AMP
Advanced Manufacturing Process®
BULLET JACKETS

NEW



CALIBER/TYPE	17 Cal. NTX®	20 Cal. NTX®	22 Cal. NTX®
Diameter	.172"	.204"	.224"
Weight	15.5 gr.	24 gr.	35 gr.
Ballistic Coef.	.115	.170	.177
Sec. Den.	.075	.082	.100
Item #	17016	22000	22240
Box Count	100	100	100





DGX[®] Bonded

The DGX[®] Bonded (Dangerous Game™ eXpanding) bullet features a copper-clad steel jacket bonded to a lead core to provide limited, controlled expansion with deep penetration and high weight retention. Bonding the jacket to the core prevents separation from high-energy impact on tough material like bone, ensuring the bullet stays together for deep expansion.

DGX[®] Bonded bullets are built to the same profile as the corresponding DGS[®] (Dangerous Game™ Solid) bullets but expand to 1½ to 2 times their bullet diameter.

The DGX[®] Bonded bullet features a flat meplat for straight penetration, maximum energy transfer and devastating results.



THICKER JACKET

The thicker 0.098" copper-clad steel jacket of DGX[®] Bonded sets it apart from other dangerous game bullets, allowing it to tear through tough material like hide, muscle and bone.

CONTROLLED EXPANSION

DGX[®] Bonded features a flat nose with serrated sections to deliver a uniform expansion from 100 to 150 yards and straight penetration, reducing possible deflections.

BONDED JACKET AND CORE

The bonding process locks the jacket and lead core together, improving the retained weight of the expanded bullet.



CALIBER/ TYPE	375 Cal. DGX [®] Bonded	400 Cal. DGX [®] Bonded	416 Cal. DGX [®] Bonded	423 Cal. DGX [®] Bonded
Diameter	.375"	.410"	.416"	.423"
Weight	300 gr.	400 gr.	400 gr.	400 gr.
Ballistic Coef.	.275	.325	.319	.315
Sec. Den.	.305	.340	.330	.319
Item #	37214	41044	41694	42404
Box Count	50	50	50	50

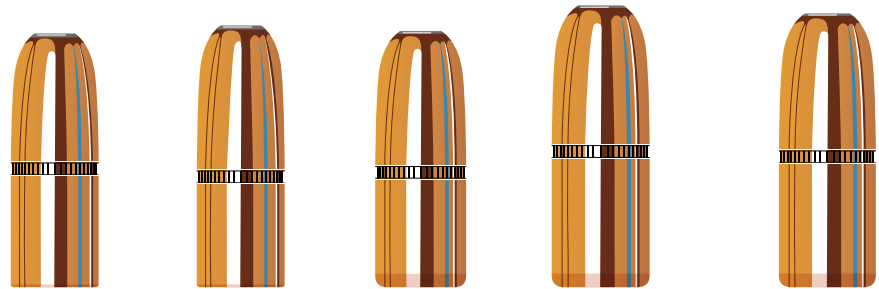

CALIBER/ TYPE	45 Cal. DGX [®] Bonded (450 Nitro Express 3¼")	45 Cal. DGX [®] Bonded	470 Cal. DGX [®] Bonded	50 Cal. DGX [®] Bonded	50 Cal. DGX [®] (505 Gibbs)*
Diameter	.458"	.458"	.474"	.510"	.505"
Weight	480 gr.	500 gr.	500 gr.	570 gr.	525 gr.
Ballistic Coef.	.285	.295	.290	.295	.270
Sec. Den.	.327	.341	.316	.313	.294
Item #	45034	45054	47474	51504	5050
Box Count	50	50	50	50	50

*This bullet is not bonded



Constructed of copper-clad steel and a high antimony lead core, the DGS® bullet is tough enough for any dangerous game.

An aggressive, hard-hitting bullet with an attitude to match, Hornady® DGS® bullets feature an advanced profile built of the toughest materials that penetrate through thick hide, dense muscle and hard bone — delivering maximum stopping power.

The business end of the DGS® bullet features a wide, flat nose that delivers maximum energy upon impact, while resisting bullet deformation and deflection. Incorporating a very hard high antimony lead core with a copper-clad steel jacket, this bullet maintains integrity and overall weight retention when driving through even the toughest hide and bone. Uniform in shape and size to the DGX® Bonded (Dangerous Game™ eXpanding) bullet, you can reliably and accurately shoot both from the same firearm with little to no shift in point of aim or impact.



CALIBER/TYPE	9.3mm DGS®	375 Cal. DGS®	400 Cal. DGS®	416 Cal. DGS®	423 Cal. DGS®
Diameter	.366"	.375"	.410"	.416"	.423"
Weight	300 gr.	300 gr.	400 gr.	400 gr.	400 gr.
Ballistic Coef.	.280	.275	.325	.319	.315
Sec. Den.	.320	.305	.340	.330	.319
Item #	3565	3727	4103	4167	4241
Box Count	50	50	50	50	50

FLAT NOSE

The flat nose reduces possible deflections and resists deformation to achieve straight, deep penetration. The DGS® provides the perfect follow-up bullet when hunting dangerous game.

DGX®/DGS® UNIFORMITY

Each caliber utilizes the same profile for both the DGS® and DGX® Bonded bullets, offering the ultimate uniformity, which is ideal when shooting both bullet types through the same firearm.

COPPER CLAD STEEL JACKET

The heavy copper clad steel jacket and high antimony lead core penetrate deeply through hide, muscle and bone.

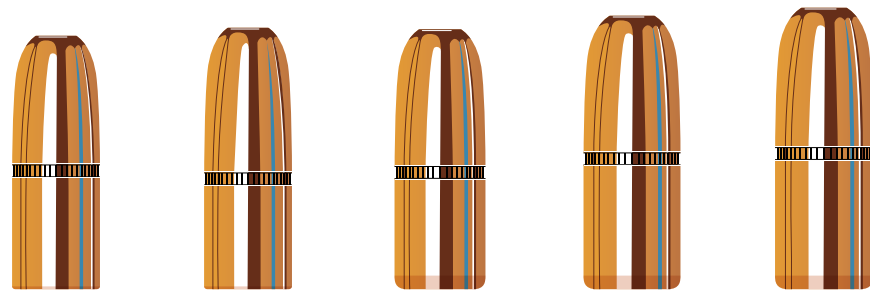

CALIBER/TYPE	45 Cal. DGS® (450 Nitro Express 3¼")	45 Cal. DGS®	470 Cal. DGS®	50 Cal. DGS® (505 Gibbs)	50 Cal. DGS®
Diameter	.458"	.458"	.474"	.505"	.510"
Weight	480 gr.	500 gr.	500 gr.	525 gr.	570 gr.
Ballistic Coef.	.285	.295	.290	.270	.295
Sec. Den.	.327	.341	.316	.294	.313
Item #	45033	4507	4748	5051	5155
Box Count	50	50	50	50	50





InterLock®

Our traditional line of bullets feature conventional exposed lead tips for controlled expansion and hard-hitting terminal performance. Most have our pioneering secant ogive design — one of the most ballistically efficient profiles ever developed (see diagram to right). Most feature our exclusive InterLock® design — a raised ring inside the jacket that is embedded in the bullet's core that keeps the core and jacket locked together during expansion to retain mass and energy.

INNER GROOVES

Strategically weaken the upper section of the jacket, ensuring consistent, controlled expansion, even at long range.

TAPERED JACKET

Jacket thickness is precisely controlled for expansion at all velocities.

ONE-PIECE CORE

Does not separate like two-piece divided cores. The InterLock® retains more mass and energy for deep penetration and large, consistent wound channels that ensure quick, clean kills.

CANNELURE

Provides accurate and consistent crimping and also works with InterLock® ring to ensure the core and jacket remain locked during expansion.

INTERLOCK® RING

The raised InterLock® ring is embedded in the bullet's core, ensuring the core and jacket are locked in one piece during expansion to retain mass and energy.



SECANT OGIVE DESIGN

Pioneered by Hornady® for use in hunting bullets, this technology broke new ground in ballistic engineering and is now used in bullets for everything from match to varmint shooting.

The secant ogive is a geometrically developed design that creates the most ballistically efficient profile, yet retains the optimum bearing surface. The combination of the slender point and increased bearing surface results in lower drag, increased stability, flatter trajectories, and amazing accuracy.



SPIRE POINT (SP)

Used as hunting bullets, the spire point offers dependable expansion at moderate ranges.



FLAT POINT (FP)

This hunting bullet design provides controlled expansion with a profile that is safe for tubular magazines.



ROUND NOSE (RN)

This hunting bullet design is for use at short to moderate ranges, specifically for brush and woodlands hunting. It is designed to expand and mushroom dependably as it penetrates game.



SPIRE POINT RECOIL PROOF (SP-RP)

A spire point bullet made for heavy-recoil cartridges with a protective tip to avoid deformation.

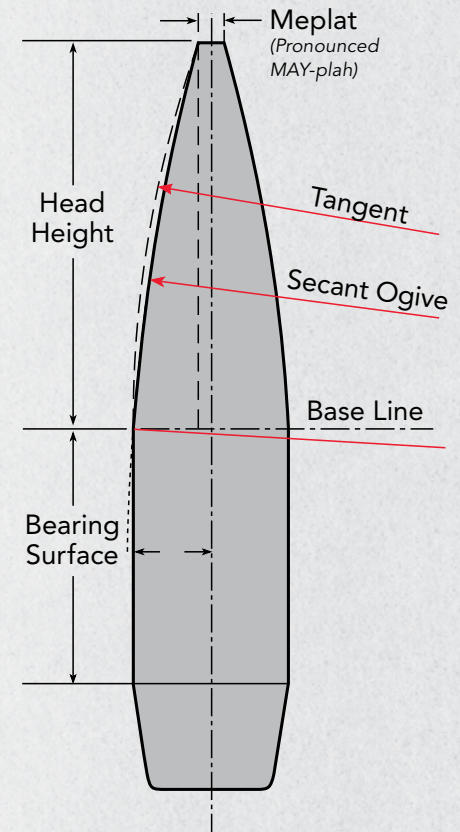



CALIBER/ TYPE	6mm BTSP	25 Cal. RN	25 Cal. BTSP	6.5mm SP	6.5mm SP	6.5mm RN	270 Cal. SP	270 Cal. BTSP	270 Cal. SP	7mm SP	7mm BTSP	7mm SP	7mm BTSP
Diameter	.243"	.257"	.257"	.264"	.264"	.264"	.277"	.277"	.277"	.284"	.284"	.284"	.284"
Weight	100 gr.	117 gr.	117 gr.	129 gr.	140 gr.	160 gr.	130 gr.	140 gr.	150 gr.	139 gr.	139 gr.	154 gr.	162 gr.
Ballistic Coef.	.405	.243	.391	.445	.465	.283	.409	.486	.462	.392	.453	.433	.514
Sec. Den.	.242	.253	.253	.264	.287	.328	.242	.261	.279	.246	.246	.273	.287
Item #	2453	2550	2552	2620	2630	2640	2730	2735	2740	2820	2825	2830	2845
Box Count	100	100	100	100	100	100	100	100	100	100	100	100	100

IMPACT VELOCITIES:



30 cal. 150 gr. SP
2700 fps
70% Wt. Ret.
.560" Expanded



30 cal. 180 gr. BTSP
2850 fps
75% Wt. Ret.
.550" Expanded



NICK EARIXSON

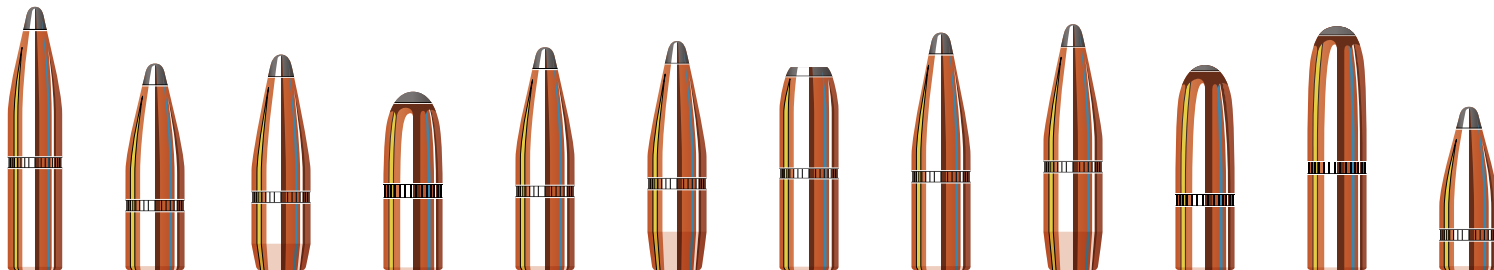

CALIBER/ TYPE	7mm SP	30 Cal. SP	30 Cal. BTSP	30 Cal. RN	30 Cal. SP	30 Cal. BTSP	30 Cal. FP	30 Cal. SP	30 Cal. BTSP	30 Cal. RN	30 Cal. RN	7.62 x 39 mm SP
Diameter	.284"	.308"	.308"	.308"	.308"	.308"	.308"	.308"	.308"	.308"	.308"	.310"
Weight	175 gr.	150 gr.	150 gr.	150 gr.	165 gr.	165 gr.	170 gr.	180 gr.	180 gr.	180 gr.	220 gr.	123 gr.
Ballistic Coef.	.462	.338	.349	.186	.387	.435	.189	.425	.452	.241	.300	.252
Sec. Den.	.310	.226	.226	.226	.248	.248	.256	.271	.271	.271	.331	.183
Item #	2850	3031	3033	3035	3040	3045	3060	3070	3072	3075	3090	3140
Box Count	100	100	100	100	100	100	100	100	100	100	100	100



InterLock[®]



CALIBER/ TYPE	303 Cal. SP	303 Cal. RN	32 Cal. FP	8mm SP	8mm RN	8mm SP	338 Cal. SP-RP	338 Cal. RN	338 Cal. SP-RP	35 Cal. SP (350 Legend)
Diameter	.312"	.312"	.321"	.323"	.323"	.323"	.338"	.338"	.338"	.355"
Weight	150 gr.	174 gr.	170 gr.	150 gr.	170 gr.	195 gr.	225 gr.	250 gr.	250 gr.	170 gr.
Ballistic Coef.	.361	.262	.249	.290	.217	.410	.397	.291	.431	.215
Sec. Den.	.220	.255	.236	.205	.233	.267	.281	.313	.313	.193
Item #	3120	3130	3210	3232	3235	3236	3320	3330	3335	3501
Box Count	100	100	100	100	100	100	100	100	100	100



MASON SCOTCH



EMILY MIERAU



NICHOLAS SIEMENS



NOAH ANDERSON

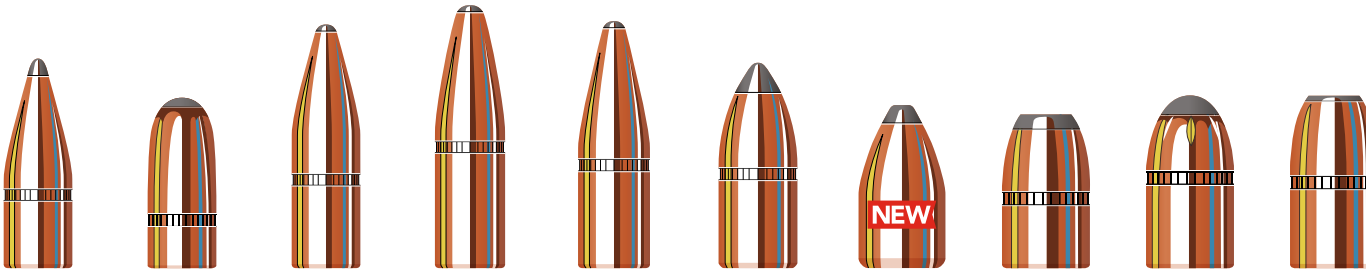

CALIBER/ TYPE	35 Cal. SP	35 Cal. RN	35 Cal. SP-RP	9.3mm SP-RP	375 Cal. SP-RP	405 Cal. SP	45 Cal. SP	45 Cal. HP	45 Cal. RN	45 Cal. FP
Diameter	.358"	.358"	.358"	.366"	.375"	.411"	.452"	.458"	.458"	.458"
Weight	200 gr.	200 gr.	250 gr.	286 gr.	270 gr.	300 gr.	245 gr.	300 gr.	350 gr.	350 gr.
Ballistic Coef.	.282	.195	.375	.400	.380	.250	.165	.197	.189	.195
Sec. Den.	.223	.223	.279	.305	.274	.254	.171	.204	.238	.238
Item #	3510	3515	3520	3560	3711	41051	45204	4500	4502	4503
Box Count	100	100	100	50	50	50	50	50	50	50

Traditional & FMJ Rifle



CALIBER/ TYPE	22 Cal. FMJ-BT W/C	22 Cal. FMJ	25 Cal. FP	30 Cal. RN	30 Cal. FMJ-RN	30 Cal. FMJ	30 Cal. HP	30 Cal. FMJ-BT	303 Cal. FMJ-BT	7.62mm FMJ
Diameter	.224"	.224"	.257"	.308"	.308"	.308"	.308"	.308"	.311"	.310
Weight	55 gr.	62 gr.	60 gr.	110 gr.	110 gr.	125 gr.	125 gr.	150 gr.	174 gr.	123 gr.
Ballistic Coef.	.243	.274	.101	.150	.178	.250	.320	.398	.470	.266
Sec. Den.	.157	.177	.130	.166	.166	.188	.188	.226	.258	.183
Item #	2267/22671/22672/2267B	22760B	2510	3015	3017/3017B	30196	30192	3037/30371/3037B	3131	3147B
Box Count	100/500/1000/6000	5500	100	100	100/3000	100	100	100/500/2100	100	2800

MITCH MITTELSTAEDT



WESTON EMERY



FMJ Handgun

Full metal jacket handgun bullets have long served as a standard for target shooting applications. Hornady® FMJ bullets are built with a rugged jacket and the difference in performance is clear. The thinly plated full metal jacket from other manufacturers is easily distorted and often breaks or separates when the bullet impacts the target. Hornady® FMJ bullets are carefully designed and manufactured to give superior functioning in semi-automatic handguns, and they deliver match-grade accuracy!



CALIBER/ TYPE	9mm FMJ-RN	9mm FMJ-RN	9mm FMJ-RN	9mm FMJ-RN-BT	10mm FMJ-FP	45 Cal. FMJ-RN
Diameter	.355"	.355"	.355"	.355"	.400"	.451"
Weight	100 gr.	115 gr.	124 gr.	147 gr.	180 gr.	230 gr.
Ballistic Coef.	.115	.140	.145	.212	.164	.184
Sec. Den.	.113	.130	.141	.167	.161	.162
Item #	35527B	35557/355571/35557B	355771/35577B	35597B	40047/400471/40047B	45177/451771/45177B
Box Count	3500	100/500/3000	500/2900	2500	100/500/2000	100/500/1500



XTP®/XTP® Mag™

Designed for hunting and self-defense, the XTP® bullet demonstrates the kind of accuracy that led many competitive shooters to adopt it. Reliable performance makes the XTP® the most popular handgun bullet for both target shooters and hunters. But it's the stopping power of the XTP® bullet that has truly built its world-class reputation. From the onset, XTP® bullets were specifically designed to expand reliably at a wide range of handgun velocities to deliver deep penetration with every shot.

CONTROLLED EXPANSION

Precise serrations divide the XTP® into symmetrical sections, strategically weakening the jacket and initiating controlled expansion even at low velocities.

NO EXPOSED LEAD

The gilding metal jacket protects the nose of the bullet, so the hollow cavity functions properly on impact and ensures proper feeding in semi-automatics.

SWAGED CORE

Total uniformity of core density ensures balanced expansion as well as in-flight stability.

DRAWN GILDING METAL JACKET

Expansion is controlled by varying the jacket thickness down the length of the XTP®, providing a definite advantage over plated bullets which have a uniform jacket thickness over the entire bullet.

CANNELURE

On revolver bullets, the cannelure helps achieve accurate, consistent crimping. All cannelures are applied before the final forming process to eliminate any distortion to the finished bullet.



IMPACT VELOCITIES:

**.45 CALIBER
XTP® MAG™**
240 gr.
1852 fps



**.45 CALIBER
XTP®**
250 gr.
1579 fps



**.45 CALIBER
XTP®**
300 gr.
1404 fps



CALIBER/ TYPE	30 Cal. XTP®	32 Cal. XTP®	32 Cal. XTP®	9mm XTP®
Diameter	.309"	.312"	.312"	.355"
Weight	90 gr.	85 gr.	100 gr.	90 gr.
Ballistic Coef.	.115	.145	.170	.099
Sec. Den.	.136	.125	.147	.102
Item #	31000	32050	32070	35500
Box Count	100	100	100	100



CALIBER/ TYPE	9mm XTP®	9mm XTP®	9mm XTP®	38 Cal. XTP®
Diameter	.355"	.355"	.355"	.357"
Weight	115 gr.	124 gr.	147 gr.	110 gr.
Ballistic Coef.	.129	.165	.212	.131
Sec. Den.	.130	.141	.167	.123
Item #	35540	35571	35580	35700
Box Count	100	100	100	100

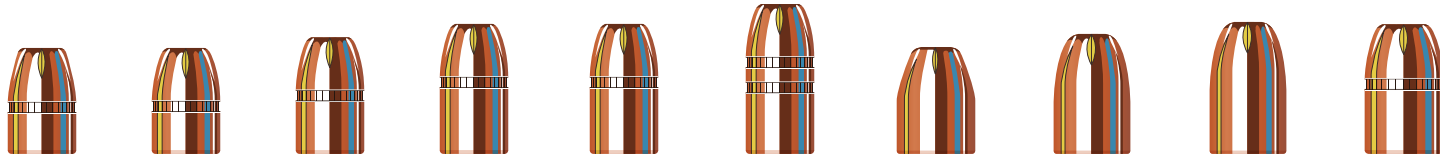

CALIBER/ TYPE	38 Cal. XTP®	38 Cal. FP-XTP®	38 Cal. XTP®	38 Cal. XTP®	38 Cal. FP-XTP®	38 Cal. XTP®	10mm XTP®	10mm XTP®	10mm XTP®	41 Cal. XTP®
Diameter	.357"	.357"	.357"	.357"	.357"	.357"	.400"	.400"	.400"	.410"
Weight	125 gr.	125 gr.	140 gr.	158 gr.	158 gr.	180 gr.	155 gr.	180 gr.	200 gr.	210 gr.
Ballistic Coef.	.151	.148	.169	.206	.199	.230	.137	.164	.199	.182
Sec. Den.	.140	.140	.157	.177	.177	.202	.138	.161	.179	.178
Item #	35710	35730	35740	35750	35780	35771	40000	40040	40060	41000
Box Count	100	100	100	100	100	100	100	100	100	100

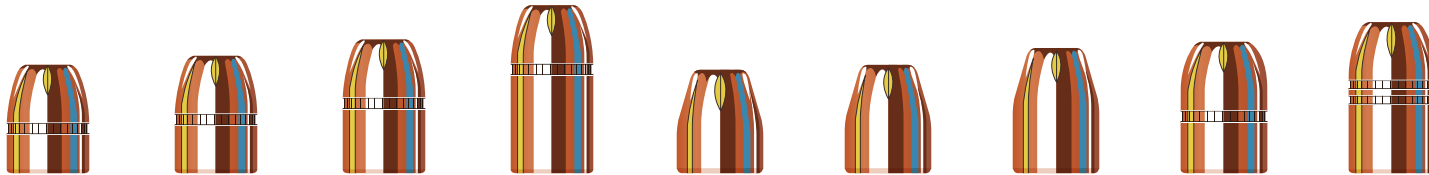

CALIBER/ TYPE	44 Cal. XTP®	44 Cal. XTP®	44 Cal. XTP®	44 Cal. XTP®	45 Cal. XTP®	45 Cal. XTP®	45 Cal. XTP®	45 Cal. XTP®	45 Cal. XTP®
Diameter	.430"	.430"	.430"	.430"	.451"	.451"	.451"	.452"	.452"
Weight	180 gr.	200 gr.	240 gr.	300 gr.	185 gr.	200 gr.	230 gr.	250 gr.	300 gr.
Ballistic Coef.	.138	.170	.205	.245	.139	.151	.188	.146	.180
Sec. Den.	.139	.155	.185	.232	.130	.140	.162	.175	.210
Item #	44050	44100	44200	44280	45100	45140	45160	45200	45230
Box Count	100	100	100	50	100	100	100	100	50

XTP® Mag™

XTP® Mag™ bullets provide the same controlled expansion, accuracy and dependability as regular XTP®'s, but are built to withstand the higher velocities and impacts from ultra-powerful, magnum handguns.

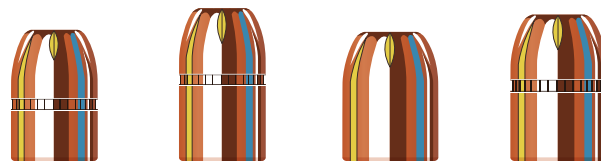

CALIBER/ TYPE	45 Cal. XTP® Mag	45 Cal. XTP® Mag	50 Cal. XTP® Mag (50 AE)	50 Cal. XTP® Mag (500 S&W Mag)
Diameter	.452"	.452"	.500"	.500"
Weight	240 gr.	300 gr.	300 gr.	350 gr.
Ballistic Coef.	.160	.200	.120	.145
Sec. Den.	.168	.210	.171	.200
Item #	45220	45235	50101	50100
Box Count	100	50	50	50





HAP®

Gain the competitive edge with Hornady® HAP® (Hornady® Action Pistol) bullets. Modeled after the legendary XTP® bullet design, HAP® bullets are further refined into the perfect competition projectile. While XTP® bullets use serrations to aid in controlled expansion and terminal performance, we have eliminated these from HAP® bullets, creating a sleek and balanced projectile with a protected nose that aids in consistent and reliable feeding in auto loading pistols. Bullet jackets, featuring industry leading concentricity combined with precision swaged cores, deliver the very best in accuracy and performance.

BUILT FOR COMPETITION

Expansion isn't an issue in action pistol shooting, so we removed the expansion-aiding skives. The result is a bullet that delivers the accuracy its sleek appearance promises.

NO EXPOSED LEAD

A jam can cost the match for a competitive shooter, and that's why our copper jacket protects the nose of our HAP® bullet.

SWAGED CORE

The core of the HAP® bullet is cold swaged from pure lead to deliver consistency, balance, and stability in flight. It delivers pinpoint accuracy with every shot.

GILDING METAL JACKET

The gilding metal jacket protects the nose and ensures smooth feeding.



JERRY MICULEK



JESSIE HARRISON



DOUG KOENIG

When you want to perform your best, you need the best bullets. The top competitors in 3-Gun and Action Pistol rely on Hornady products to deliver the accuracy and consistency needed to win, time after time.



CALIBER/ TYPE	9mm HAP®	9mm HAP®	10mm HAP®	10mm HAP®	45 Cal. HAP®	45 Cal. HAP®	45 Cal. HAP®
Diameter	.355"	.356"	.400"	.400"	.451"	.451"	.451"
Weight	115 gr.	125 gr.	180 gr.	200 gr.	185 gr.	200 gr.	230 gr.
Ballistic Coef.	.129	.158	.164	.199	.139	.151	.188
Sec. Den.	.130	.141	.161	.179	.130	.140	.162
Item #	355281/35528B	355721/35572B	400421/40042B	40061B	45105B	45159B	451611/45161B
Box Count	500/3000	500/3000	500/1900	1800	1900	1800	500/1500

Frontier® Lead

Hornady® lead pistol bullets are pre-lubricated and cold-swaged for total uniformity and balance. Our exclusive knurling system retains lubricant over the entire bearing surface to reduce leading in your barrel.

For cowboy shooters, authenticity is a strict requirement. That's why we build our Cowboy™ bullets to SASS (Single Action Shooting Society) specifications while holding them to the same stringent production standards as all our products.

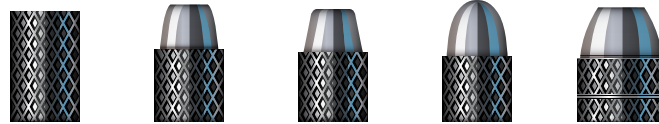

CALIBER/ TYPE	38 Cal. HBWC	38 Cal. SWC	38 Cal. SWC-HP	38 Cal. LRN	45 Cal. FP COWBOY™
Diameter	.358"	.358"	.358"	.358"	.454"
Weight	148 gr.	158 gr.	158 gr.	158 gr.	255 gr.
Ballistic Coef.	.047	.135	.139	.159	.117
Sec. Den.	.165	.176	.176	.176	.177
Item #	10208	10408	10428	10508	12458
Box Count	250	300	300	300	200

CLASSIC & CONVENTIONAL DESIGN

Traditional conical and flat designs have perfect symmetry when combined with knurling at the base of the bullet, delivering increased stability and accuracy. This ensures proper positioning in authentic revolvers, with no unwanted nicking of primers as the cylinder turns.

SPECIAL KNURLING SYSTEM

The knurling system holds an even distribution of lubricating wax over the bearing surface of the Cowboy™ bullet, resulting in less leading.



Crimp-On Gas Checks

If you cast your own bullets, our crimp-on gas checks will enhance their performance. During sizing, the gas check crimps to the base of cast lead bullets to seal gases and protect the base from deformation. **Hornady® gas checks are the only real choice for bullet casters. (1000 per box)**

22 Cal.....#7010	6.5MM.....#7040	30 Cal.....#7070	35 Cal.....#7110	45 Cal.....#7140
6MM.....#7020	270 Cal.....#7050	32 Cal. (8MM).....#7080	375 Cal.....#7120	
25 Cal.....#7030	7MM Cal.....#7060	338 Cal.....#7090	416 Cal.....#7125	



AMMO PLANT™

AP™

CLASSIC™

IRON PRESS®

RELOADING

The Hornady® Lock-N-Load® system features quick tool change technology that allows you to switch rifle and pistol dies, powder dies, check dies, bullet seaters or crimp dies without having to change the whole die head. This unique technology is featured on all Hornady® presses. In addition, Hornady® conversion bushings can convert other brands to the Lock-N-Load® system.

HOW LOCK-N-LOAD® WORKS:

THE PATENTED HORNADY® LOCK-N-LOAD® SYSTEM IS AS EASY AS 1-2-3:

- 1** Insert the Lock-N-Load® die bushing into the press bushing and lock it into place with a twist. The six locking lugs on the die and press bushings will hold it securely in position.
- 2** Insert your standard die with 7/8"–14 threads into the Lock-N-Load® Bushing.
- 3** Adjust the die to the proper position and lock your setting into place with the unique Hornady Sure-Loc™ lock ring.

To change calibers, simply twist the die counterclockwise, remove die and insert your next preset Lock-N-Load® die and bushing. Because they remain locked in their Lock-N-Load® Bushings, your dies will remain exactly as you set them. The positive locking action of the Lock-N-Load® Bushings holds the dies in rock solid, perfect alignment. Once you try Lock-N-Load® from Hornady,® you'll NEVER want to go back to your old system.

U.S. Patent: 6,481,916





Lock-N-Load® Iron Press®

The Lock-N-Load® Iron Press® loader has a cast iron frame and is built to be the heaviest, most rigid press in its class. Tight tolerances in manufacturing and assembly combine to provide consistency and precision that will deliver match accurate ammunition, round-after-round, year-after-year.

Lock-N-Load® Iron Press® Loader with Manual Prime.....No. 085520

Lock-N-Load® Iron Press® Auto Prime System Upgrade..No. 085570

LOCK-N-LOAD® IRON PRESS® FEATURES:

SUPERIOR STRENGTH WITH AMBIDEXTROUS DESIGN

Industry-leading strength comes from the 1-1/8" solid steel ram, and a heavy duty spring returns the press to a neutral position for ease of use. An interchangeable handle offers ambidextrous functionality.



PATENTED SHELL HOLDER PLATFORM

The Iron Press® loader, with its patented shell holder platform, allows handloaders to deprime, pause and remove the case to chamfer and deburr, etc., then easily replace and prime.

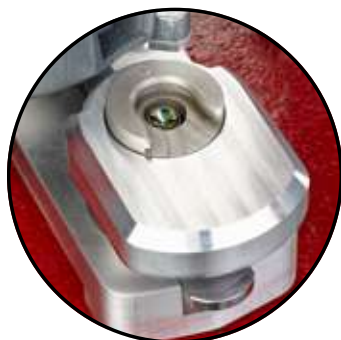

LOCK-N-LOAD® BUSHING SYSTEM

Incorporating our patented Lock-N-Load® bushing system, changeovers are lightning fast.



*Lock-N-Load® Iron Press®
loader with Auto Prime
System and select accessories.*



LOCK-N-LOAD® IRON PRESS® ACCESSORIES:

POWDER MEASURE ATTACHMENT

This metal bracket attaches to the Iron Press® and holds your Powder Measure in place for convenient use.

**Powder Measure Attachment
No. 399694**



AUTOMATIC PRIMING SYSTEM

The gravity fed Automatic Priming System helps increase reloading efficiency by allowing more processes to happen simultaneously. Sold separately or with the Kit.

No. 085570



IRON PRESS® DIE CADDY

The optional die caddy provides storage for dies, as well as mounting points for cutting tools and component bins to hold bullets, cases, or loaded rounds.

**Iron Press® Die Caddy
No. 399683**



LOCK-N-LOAD® IRON PRESS® KIT

Blurring the lines between single stage and progressive reloading, the Lock-N-Load® Iron Press® Kit is a full-featured reloading kit offering rugged reliability for years of precision reloading.

No. 085521

INCLUDES:

- Automatic Priming System
- Die Caddy
- Component Feed Bin & Bracket
- Lock-N-Load® Bench Scale
- Powder Measure
- Reloading Handbook
- Unique™ Case Lube
- Lock-N-Load® Bullet Comparator Set of 6
- Lock-N-Load® Die Bushings 3-pack
- Powder Funnel 22-45 cal
- Digital Caliper
- Shell Holder Kit (#1, #2, #5, #16, #35)
- Case prep accessories:
 - chamfer & deburr tool, large & small primer pocket cleaners, neck brushes (22 cal, 6mm/25 cal/6.5mm, 270 cal/7mm, 30 cal, 35 cal, 45 cal)

**Extra bracket and bin
(sold separately)**

No. 399684



**GET LOADED!
FREE BULLETS
WITH PURCHASE!
— SEE PAGE 93 —**



Lock-N-Load[®] Classic[™]

LOCK-N-LOAD[®] QUICK CHANGE BUSHING SYSTEM

Lock-N-Load[®] bushings not only let you switch from one die to another in a matter of seconds, they also offer the quickest and easiest die setup on the market. Just set the die and tighten the Sure-Loc[™] ring on the Lock-N-Load[®] bushing. Quickly remove and re-install without the need to readjust the die or keep a separate seater die for each of your pet loads.

EASY GRIP HANDLE

Large, ball-style grip reduces fatigue. The long handle increases leverage and reduces effort.

POWER-PAC LINKAGE AND SOLID STEEL ARMS

Arms rotate on steel pins that run completely through the cast frame. The Power-Pac linkage design multiplies the leverage you apply to the handle, making it easier to size cases and reduces user fatigue.

STRONG ANGLED FRAME

This high strength alloy frame offers the rigidity and stability needed for precision reloading, and is never going to break or fail. The frame's unique angle gives the reloader greater visibility and easier access to the cartridge in the press.

POSITIVE PRIMING SYSTEM[™] (PPS)

Once the spent primer ejects at the top of the stroke, you can add a new primer to the PPS and it self-aligns to feed and insert the primer at the bottom of the stroke where leverage is best. Our self-aligning primer arm also



allows for easy manual inserting of primers without having to raise the handle. All the work is done at the bottom of the stroke. Works easier than ram prime units and much better than old style primer arms. Small and large punch included.

Lock-N-Load[®] Classic[™] Press No. 085001

AUTOMATIC PRIMER FEED (OPTIONAL)

Includes both large and small primer tubes. Use with our Positive Priming System[™] and there's no more fumbling with primers — priming is 100% hands off. Sold separately. **No. 070905**



Lock-N-Load® Kits

**GET LOADED!
FREE BULLETS
WITH PURCHASE!
— SEE PAGE 93 —**

LOCK-N-LOAD® CLASSIC™ KIT

Perfect for the reloading novice, this kit offers everything you need to get started. (Reloading dies and shell holders sold separately.)

No. 085003

INCLUDES:

- Lock-N-Load® Classic™ single stage press
- Lock-N-Load® Powder Measure
- Digital Scale
- Three Lock-N-Load® Die Bushings
- Primer Catcher
- Positive Priming™ System
- Handheld Priming Tool
- Universal Reloading Block
- Chamfering and Deburring Tool
- Powder Trickler and Funnel
- One Shot® Case Lube
- Hornady® Handbook of Cartridge Reloading



**GET LOADED!
FREE BULLETS
WITH PURCHASE!
— SEE PAGE 93 —**

LOCK-N-LOAD® CLASSIC™ KIT DELUXE

In addition to everything you receive in the Classic™ Kit (above), the Deluxe Classic™ Kit includes shell holders in the most popular sizes, bushings and Sure-Loc™ rings, as well as some other handy tools.

No. 085010

INCLUDES:

- Lock-N-Load® Classic™ Kit contents (above)
- Sure-Loc™ Lock Ring 6 Pack
- Powder Measure Stand
- Shellholders 1,2,5,16,35
- Kinetic Bullet Puller
- Lock-N-Load® OAL Gauge (Straight)
- Vintage Tin Sign
- Pistol Rotor & Metering Assembly
- Steel Dial Caliper

LOCK-N-LOAD® PRECISION RELOADERS KIT

Designed to help you produce the most accurate reloads possible, the Lock-N-Load® Precision Reloaders Kit includes tools and gauges that allow the user to fine-tune the reloading process. This time and money-saving kit helps precision reloaders check for bullet runout, head spacing and overall consistency of round-to-round production.

No. 095150

INCLUDES:

- Concentricity Tool
- Cam Lock™ Trimmer
- Cam Lock™ Power Adapter
- Lock-N-Load® OAL Gauge Curved
- Lock-N-Load® Case Prep Trio
- Steel Dial Caliper
- Lock-N-Load® Comparator Set
- Lock-N-Load® Comparator Headspace Kit



LOCK-N-LOAD® 50 CAL BMG

Reload your own 50 BMG rounds with accuracy and precision. This single stage press features our exclusive Lock-N-Load® technology in the ram, which means you can change your shell holder over to ram-prime, then move the shell holder to the top plate. Once the holder and ram-prime are set, they stay that way. A quick change to a Lock-N-Load® bushing makes switching over from ram-prime to die use faster, too.

No. 085004

- 50 Cal. BMG Powder Measure..... **No. 050127**
- High Capacity Metering Kit..... **No. 050126**
- Primer Seating Gauge..... **No. 050150**
- Shell Head Adaptor..... **No. 392172**
- Conversion Bushing..... **No. 392301**



50 CALIBER BMG PRESS KIT

Includes the Hornady® 50 BMG reloading press, a complete set of Hornady® 50 BMG reloading dies, and a 50 BMG shell holder. It also comes with a 1½"x12 bushing to convert the die head to our Lock-N-Load® system which will hold any standard 7/8"-14 die.

No. 085005



Lock-N-Load[®] AP[™]

**GET LOADED!
FREE BULLETS
WITH PURCHASE!**
— SEE PAGE 93 —

The Hornady[®] Lock-N-Load[®] AP[™] press is a professional grade, auto indexing, 5-station progressive press that features the patented Lock-N-Load[®] bushing system, as well as a host of other features that make it more intuitive and better-equipped for all your reloading needs.

No. 095100

*All you need are
dies and shell plates to start
loading with your AP[™]!*

SEE PAGES 142-148



QUICK CHANGE LOCK-N-LOAD[®] BUSHING SYSTEM

Lock-N-Load[®] AP[™] has a 5-station quick change bushing system that allows quick and easy change overs from one caliber to another.



QUICK CHANGE METERING INSERTS

The Lock-N-Load[®] powder measure uses quick change metering inserts that allow you to switch from one powder to another with the push of a button. Add one to each die set for the ultimate in quick change overs.





RELIABLE EZ-JECT™ SYSTEM

Ensures reliable ejection of cartridges every time, without any adjustments.

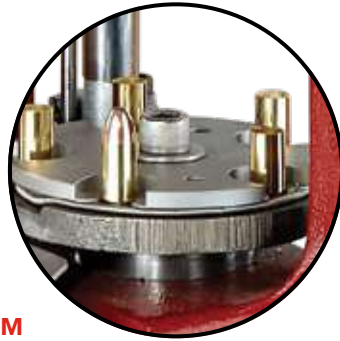

UNIVERSAL CASE RETAINER SPRING

Allows quick and easy removal or insertion of cases at any point in the loading process.



PRIMING SYSTEM

Change from large to small primers in three easy steps:

- 1) Change the primer seater punch.
- 2) Change the primer shuttle.
- 3) Change the primer feed tube.



CASE ACTIVATED POWDER DROP

Dispenses a powder charge only when a cartridge case is present.

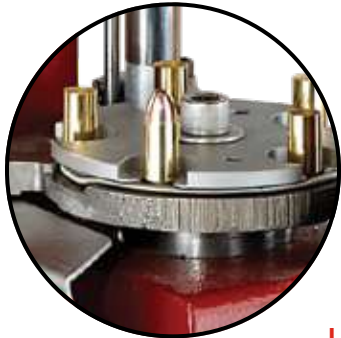

AUTOMATIC INDEXING

Each station moves half a stage on the down stroke and half on the up stroke, making for ultra smooth functioning. This process is much smoother than presses that do all their indexing on the down stroke.



LARGE CAPACITY CARTRIDGE CATCHER

A large capacity catcher comes standard with the Lock-N-Load® AP™ Press and is also sold separately. An extra large capacity catcher is available as an option.

No. 480038

Lock-N-Load® Ammo Plant™

Turn your progressive press into a bench mounted ammo factory! This kit represents the ultimate reloading setup for maximum production in shorter sessions.



THE LOCK-N-LOAD® AMMO PLANT™ INCLUDES THE FOLLOWING:

- Lock-N-Load® AP™ Press
- Lock-N-Load® AP™ Pistol Bullet Feeder
- Lock-N-Load® AP™ Case Feeder
- Lock-N-Load® Die Bushing 10 pack
- Cartridge Bins (x3)
- Large Primer Pickup Tubes (x3)
- Small Primer Pickup Tubes (x3)
- Primer Slide Spring (x2)
- Pistol Metering Insert and Rotor
- Rifle Metering Insert and Rotor
- Powder Cop
- Deluxe Die Wrench
- Case Activated Powder Drop
- Lock-N-Load® Powder Measure
- Vintage Tin Sign
- Deluxe Spent Primer Catcher

No. 095160

**GET LOADED!
FREE BULLETS
WITH PURCHASE!
— SEE PAGE 93 —**

COMPLETE YOUR RELOADING EXPERIENCE BY CHOOSING A CALIBER AND THESE ESSENTIAL TOOLS (SOLD SEPARATELY):

- Die Sets
- Bullet Feeder Die
- Shell Plates
- Case Feeder Plates

See chart on pages 142-148 for listings.



Lock-N-Load® AP™ Accessories

**GET LOADED!
FREE BULLETS
WITH PURCHASE!
— SEE PAGE 93 —**

RIFLE BULLET FEEDER

Turn your progressive reloading press into a bench mounted ammo factory! Sold as a complete unit for 22 caliber bullets. We also offer a conversion kit for 30 caliber bullets, giving the reloader the versatility to load the two most popular calibers. Plus, it's compatible with other presses and uses the industry standard 7/8"-14 die threads (30 Cal. Conversion Kit sold separately).

Coupled with the Lock-N-Load® Case Feeder, you'll realize dramatic increases in efficiency and reloading speed — up to 50% faster (depending on experience and proficiency).

The Bullet Feeder Die is case activated; the bullet will only feed upon contact with the case. A single station is used to feed, seat, and crimp the bullet.

Rifle Bullet Feeder (22 Cal.) No. 095340

30 Cal. Conversion Kit No. 095345

Note: The Rifle Bullet Feeder System must be purchased separately from the Hornady® Pistol Bullet Feeder because the hopper systems and die bodies are not compatible. Cast lead bullets cannot be used in any Hornady® bullet feeders.



The case-activated Rifle Bullet Feeder is also compatible with the Dillon model XL 650.





**GET LOADED!
FREE BULLETS
WITH PURCHASE!
— SEE PAGE 93 —**

LOCK-N-LOAD® CASE FEEDER

With our high volume Lock-N-Load® Case Feeder, the Lock-N-Load® AP™ just got faster. It has the highest torque motor in the industry and an extra large case bowl that makes it possible to load over 500 rounds of high quality ammunition per hour, depending on experience and proficiency. The Lock-N-Load® Case Feeder comes complete with everything you need except the case feeder plates, which are sold separately. (See chart on pages 142-148.) **No. 095300**

ADAPTS TO YOUR LOCK-N-LOAD® AP™ PRESS

The Case Feeder bolts to Lock-N-Load® AP™ presses with serial number 7000 and higher. For serial numbers below 7000, we offer a sub-plate conversion kit.

*For details, give us a call at 1-800-338-3220.
(Not compatible with the Projector™ press.)*

CHANGE OVERS ARE EASY

Changing the Lock-N-Load® Case Feeder from one cartridge to another is quick and simple. Change overs typically take about 5 minutes.

FEEDS EVERY CARTRIDGE

If Hornady® makes a standard shell plate for it, the cartridge will also feed through the hopper.

FAIL-SAFE CASE SLIDE MECHANISM

Slotted cam wire fixture prevents damage from misfed cases or incorrectly adjusted shuttle.

CARTRIDGE ADAPTORS INCLUDED

The Case Feeder comes with six cartridge adaptors to ensure proper feeding of your cases into the shell plate. The instructions include a V-Block usage chart so there's no guessing about which adapter to use.



**Small Pistol
No. 095310**



**Large Pistol
No. 095312**



**Small Rifle
No. 095314**



**Large Rifle
No. 095316**

CASE FEEDER PLATES ARE SOLD SEPARATELY.

See charts on pages 142-148.



Lock-N-Load® AP™ Accessories

GET LOADED!
FREE BULLETS
WITH PURCHASE!
— SEE PAGE 93 —



PISTOL BULLET FEEDER

The Lock-N-Load® Pistol Bullet Feeder is designed for the Lock-N-Load® AP™, but can be used with any other press using 7/8"-14 die threads, and requires an open station. Coupled with the Lock-N-Load® Case Feeder (sold separately), you'll realize dramatic increases in efficiency and reloading speed. (Up to 50% faster!)

The easy-feed bullet hopper holds up to 200 pistol bullets and features an adjustable center plate and bullet feed wipers to ensure smooth feeding.

No. 095320



Pistol Bullet Feeder does not work with lead or plated bullets.

PISTOL BULLET FEEDER DIES

(NEEDED FOR LOCK-N-LOAD® BULLET FEEDERS)

Bullet Feeder Dies are case activated – a bullet will only feed upon contact with a case. The collets are precision machined of solid steel for each caliber.

ITEM	PISTOL
095330	380 Auto/9mm Luger
095331	38 Spl/357 Mag
095332	40 S&W/10mm Auto
095333	44 Spl/Mag
095334	45 Auto (.451/.452)

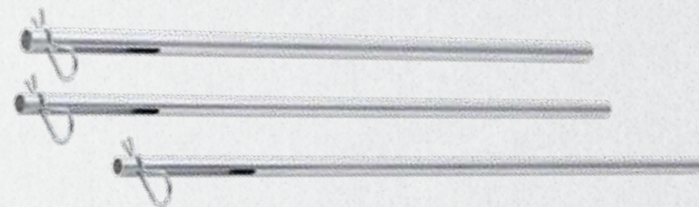

LOCK-N-LOAD® BULLET TUBES

Hornady® Lock-N-Load® Bullet Tubes for pistol bullets provide a handy, economical way to utilize bullet feeder dies on progressive presses without the complete bullet feeder hopper system. Tubes fit 40+ bullets depending on caliber and weight, and feature a window revealing when quantities are low. Sold in 3-packs.

Bullet Tube 9mm No. 095350

Bullet Tube 40 S&W/10mm No 095351

Bullet Tube 45 Auto No. 095352

Bullet Tubes connect quickly and easily with Bullet Feeder Dies.



POWDER THROUGH™ EXPANDERS

Powder Through™ Expanders (PTX™) are designed to work in conjunction with the Case Activated Powder Drop. These Expanders eliminate the need for a separate case mouth expander die on the Lock-N-Load® AP™ press, freeing up an extra station for a taper crimp die or powder cop. The Expanders work for lead, plated and jacketed bullets.



Caliber	Bullet Dia.	PTX™ Item No.	Caliber	Bullet Dia.	PTX™ Item No.
308	.308"	290050	45 Auto	.451-.452"	290034
9mm	.355-.356"	290030	45 Colt	.452-.454"	290036
357	.357-.359"	290031	475	.475-.476"	290037
10mm	.400-.401"	290032	50	.500-.501"	290038
44	.429-.430"	290033			

HORNADY® POWDER COP

Install on your progressive press after the powder drop station to automatically check dropped charges. Checking powder charges on your progressive press can be difficult, and is sometimes ignored, even though it's a smart practice. Hornady® uses a similar device on our own ammo manufacturing presses. It won't replace careful attention, but helps monitor the reloading process. Works with all powder types and cartridges.



No. 050063



Over Charge

Correct

Under Charge

PTX™ POWDER MEASURE STOP

This component is an add-on to your Case Activated Powder Drop that allows the reloader to adjust the flare on cases utilizing the top and bottom adjustment screws.

No. 290049

(Comes standard with new AP™ presses and Case Activated Powder Drop)



LOCK-N-LOAD® AP™ PRIMER POCKET SWAGE TOOL

Quickly and cleanly removes crimps on cartridge case primer pockets. Designed to be used on the Lock-N-Load® AP™ press, the Primer Pocket Swage Tool comes with shell plate and dies for feed, swage, and eject to make your job easier.

Swage depth can be adjusted to accommodate various case brands. Swaging out the crimps on primer pockets instead of cutting them eliminates trimmings and mess.

223/5.56 No. 041217

308/7.62x51 No. 041218

CASE ACTIVATED POWDER DROP

Engineered with quick change-overs in mind, the case activated powder drop only dispenses a powder charge when a case is present. Designed for the Lock-N-Load® AP™ but will work in any progressive press that uses 7/8"-14 threads.

Not compatible with Blackpowder Measure.

No. 050073

.17 cal. Powder Sleeve (sold separately) No. 392703



QUICK CHANGE POWDER DIE

Designed specifically for use with the Case Activated Powder Drop (#050073), this accessory makes changing over your Lock-N-Load® AP™ faster and easier than ever! Includes lower bracket with guide bushing and lock ring. Our Powder Through™ Expanders (left) are designed for use with the Quick Change Powder Die.

No. 050074





Lock-N-Load[®] AP[™] Accessories

POWDER FUNNEL DIE

For ultra precision on the AP[™] press, this die allows handloaders to trickle and weigh each individual powder charge. Includes two insert bushings that accommodate cases from .22 to .50 caliber.

No. 095360



LOCK-N-LOAD[®] AP[™] TOOL CADDY

Improve efficiency and convenience by storing frequently used tools directly on your AP[™] press. Install the bracket and caddy on either side of the press and rotate to the desired position. Then, insert supplied tools, including three combination wrenches, four hex wrenches, needle nose pliers, and a Hornady[®] Deluxe Die Wrench, for quick access and efficient organization.

No. 095140



SHELL PLATES

The subtle radius of each shell holder mouth ensures smooth and reliable functioning. The retainer spring is designed to stay in place when inserting cases into the shell plate. To determine the shell plate required for your application, please refer to the chart on pages 142-148. A single shell plate may be used for multiple calibers.

SEE SIZING CHART ON PAGES 142-148.

(Custom plates are also available.)



LOCK-N-LOAD[®] DIE AND CONVERSION BUSHINGS

Simply thread a Hornady[®] Lock-N-Load[®] Conversion Kit into your RCBS[®] Rock Chucker or other reloading press using a 1¹/₄"-12 thread, and you're ready to start using the Lock-N-Load[®] System. It's the easiest way to get the most out of your reloading press. These bushings let you take advantage of Hornady's[®] Lock-N-Load[®] technology even if you own a competitor's reloading press. The Lock-N-Load[®] Conversion Kit includes three Lock-N-Load[®] bushings and one conversion bushing.

- Lock-N-Load[®] Press Conversion Bushings No. 044095**
- (2-pk.) Die Bushings No. 044094**
- (3-pk.) Die Bushings No. 044093**
- (10-pk.) Die Bushings No. 044096**
- Lock-N-Load[®] Conversion Kit..... No. 044099**

GET / 2020 LOADED®

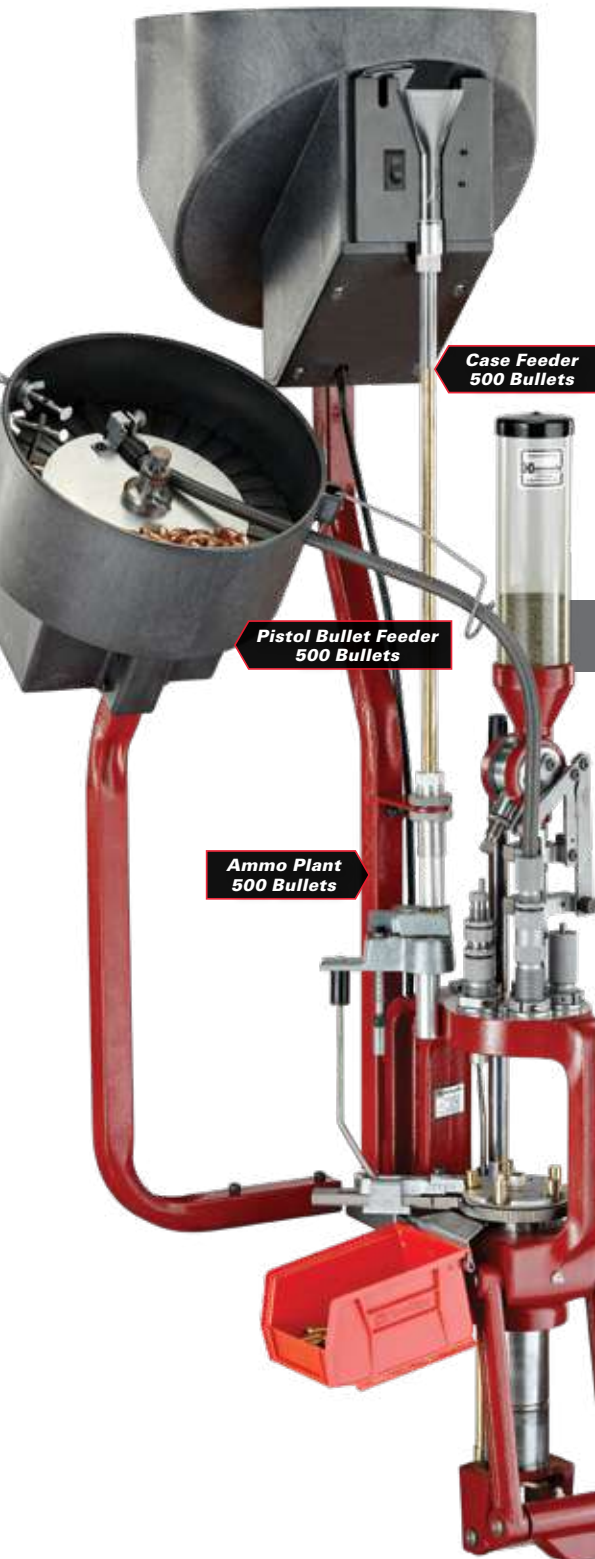

Case Feeder
500 Bullets

Pistol Bullet Feeder
500 Bullets

Ammo Plant
500 Bullets

There's no better time to stock your reloading bench.
Choose from the most durable, precise and convenient tools
on the market and receive free bullets to get you started!

500 FREE BULLETS

With the purchase of one of
these Lock-N-Load® products:

- Iron Press® Kit
- Ammo Plant
- AP™ Press
- Classic™ Kit
- Classic™ Kit Deluxe
- Classic™ Kit with Auto Charge®
- Case Prep Center
- Bullet Feeder
- Case Feeder



100 FREE BULLETS

With the purchase of
one of these products:

- Custom Grade™ Die Sets
- Match™ Grade Die Sets
- Lock-N-Load®
Case Prep Trio
- Case Prep Duo





Powder Measures & Accessories



HORNADY® LOCK-N-LOAD® POWDER MEASURE

The pioneering design of the quick change Lock-N-Load® Powder Measure has been copied by others but never replicated. Offering the most flexible operation and widest range of use, the Lock-N-Load® Powder Measure can handle charges of .5 to 265 grains of powder when paired with the appropriate insert and rotor. Metering inserts can be changed with the push of a button, giving handloaders the ability to load everything from small pistol cartridges to large magnums without having to purchase multiple powder measures. Includes rifle rotor and metering insert. Pistol rotor and inserts sold separately. **No. 050069**

FEATURES

LARGEST CHARGE RANGE IN THE INDUSTRY

By simply changing rotor and inserts, you can use one Lock-N-Load® Powder Measure to load powders and charges from .5 grain to 265 grains.

PUSH-BUTTON RELEASE FUNCTION

To change metering inserts, simply push the release button and change over to another metering insert. Verify the new charge and you're reloading again right away. Inserts can be swapped in seconds. Go from reloading 30-06 to 45 Auto in no time. Keep the preset inserts with your die sets.

PRECISION TOLERANCE

With only .002" clearance between the drum and rotor, it's the tightest in the industry for a standard measure. This tight tolerance helps eliminate powder binding between the frame and drum, delivering smooth function with all types of propellant – extruded or ball.

PISTOL ROTOR AND STANDARD PISTOL METERING INSERT

For use in your Lock-N-Load® Powder Measure, this pistol rotor features a smaller chamber for more precise metering of charge weights between .5 and 17 gr.

Pistol Rotor and Standard Pistol Metering Insert No. 050128

Standard Pistol Metering Insert for Pistol Rotor No. 050116



MULTIPLE MOUNTING METHODS

Mount to your bench using a standard mounting bracket and lock ring, or use our Lock-N-Load® bushings to mount this versatile measure on the Fast Load Powder Measure Stand (featured on page 105).

ADJUSTABLE TENSION

The O-ring on the metering insert adjustment lets you put a slight amount of tension on the metering unit to make fine, incremental adjustments. Once you've set your charge, tighten the lock ring to secure the setting.

SMALL AND LARGE DROP TUBES

These tubes speed up powder flow. Two drop tubes are included for .204 to 45 calibers. Use the largest drop tube that fits the case mouth. There is an optional extended drop tube that is also available. Optional 17 caliber drop tube sold separately. **No. 390709**



Just push the button and remove the metering insert — no more messing around adjusting powder charges every time you change over.

Label your inserts for quick identification and easy reference.





POWDER MEASURE METERING INSERTS

Switch these metering units in and out of your Lock-N-Load® Powder Measure with just the push of a button. (Not compatible with the Bench Rest Grade Powder Measure.)



STANDARD METERING UNIT INSERT

Meters from 15 to 100 grains of powder (included with Lock-N-Load® Powder Measure).

Rifle Standard Metering Unit Insert No. 050120

Pistol Standard Metering Unit Insert No. 050116



POWDER MEASURE DRAIN INSERT

Replaces a metering insert so you can drain powder without removing the measure from its stand. (Compatible with Bench Rest Grade Powder Measure.)

No. 050125

MICROMETER INSERTS

For precise measurements, the micrometer inserts allow the user to make and monitor incremental changes and return to previous settings.



Rifle Micrometer Metering Insert No. 050124



Pistol Micrometer Metering Insert No. 050129



BENCH REST METERING INSERT

Use with the Lock-N-Load® Bench Rest Powder Measure. The micrometer insert allows the user to make and monitor incremental changes and return to previous settings.

No. 050114

HIGH CAPACITY METERING KIT

The kit's two metering units have capacities of 80 to 180 grains and 165 to 265 grains of powder, and come with the clear drop tube and large hopper tube. The clear drop tube visually ensures a complete powder drop and the extended hopper tube allows you to reload more rounds between refills of powder. Fits Hornady® Lock-N-Load® Powder Measure.

No. 050126



LOCK-N-LOAD® BENCH REST GRADE POWDER MEASURE

You'll receive all the advantages of Lock-N-Load® technology with the added benefit of more precise measuring. That precision comes from a specially designed chrome-plated metering insert and a smaller metering chamber to promote more consistent and uniform filling.

The micrometer adjustment gives positive reference for metering adjustments and you can install pre-set metering units by simply pushing the button on the outside of the metering chamber. Measurements adjust from 20 to 65 grains. All moving parts have been plated for protection and long life, and the rotor requires NO lubrication.

No. 050130





Scales & Accessories

G2-1500 ELECTRONIC SCALE

This compact, battery operated trickle-compatible scale offers a maximum reference measurement of 1500 grains. Unlike other scales on the market, it features a precision load cell with 1/10th grain accuracy and constant readout up to 500 grains, offering the flexibility to trickle powder into the pan or weigh charges, bullets or cases directly. You can trust this scale to make quick work of your most precise handloading tasks. Includes two AAA batteries.

No. 050106



POWDER FUNNEL

Anti-static funnel fits all calibers between 22 and 45. Squared rim design won't roll off the table.

**Powder Funnel
No. 586050**

**17 Cal. Funnel Adapter
No. 586055**



POWDER TRICKLER

Trickle the last few tenths of a grain of powder into a dropped and weighed charge for "0" variation. Features a wide, stable base, is easy to clean, and uses a small amount of powder to fill.

No. 050100



LOCK-N-LOAD® BALANCE BEAM SCALE

The Hornady® Balance Beam Scale is an essential tool for any well-stocked reloading bench. Its classic, time-proven balance system provides a measurement range from 0 to 500 grains with 0.1 grain sensitivity, and will easily handle most reloading tasks. A magnetic dampener provides fast, accurate measurements. The balance bar is laser etched, easy to read, and will not flake or peel. Made in the USA.

No. 050109

LOCK-N-LOAD® BENCH SCALE

Made from the same high quality, precision load cell found on the Lock-N-Load® Auto Charge®, the high performance Lock-N-Load® Bench Scale is the perfect addition to your reloading bench. With a capacity of 1500 grains, you can weigh powder, bullets, cases, cartridges and more. The large LCD display is easy to read and weighs precisely to a tenth (0.1) of a grain. Included are two calibration weights, AC adaptor, 220V adaptor, and metal powder pan.

No. 050108





AUTO CHARGE® PRO POWDER MEASURE **NEW**

The new Hornady® Auto Charge® Pro provides precise, customizable powder dispensing in an easy-to-use, space-saving unit. Accurate to within 0.1 grain, the Auto Charge® Pro offers customizable trickle speeds for various powder types, as well as custom time settings. Store settings for up to four custom loads or use the factory setting. The backlit touch screen is easy to read, while a large knob on the side simplifies powder emptying. Other features include large powder capacity, built-in bubble level and smaller footprint than competing brands. Included are two calibration weights, AC adaptor, 220V adaptor, metal powder pan, and brush.

No. 050053



VIBRATORY TRICKLER

Save time and improve reloading accuracy and efficiency with the Vibratory Trickler. High, low and variable settings trickle all forms of powder. Modular design allows user to position Trickler body where needed and makes cleanup quick and easy.

- Ideal for getting loads exactly the same every time.
- High, low and variable settings trickle all forms of powder.
- Modular design allows user to position trickler body where needed.
- Powered by two AAA batteries.

No. 050102



LOCK-N-LOAD® QUICK TRICKLE™

This versatile powder dispenser features manual high and low speeds with up to a three-to-one gear ratio. Combined with double-sided, sealed ball bearings that prevent stray powder from impeding operation, the Quick Trickle™ is the smoothest operating manual powder dispensing tool for your reloading bench.

No. 050101

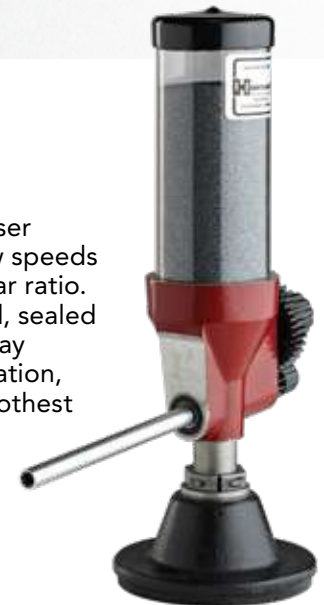



Cartridge Cases



THE FOUNDATION OF HORNADY® AMMUNITION

At Hornady,® brass is the foundation for what could be the most memorable shot of your lifetime. Extra time and care is taken in the creation of our cases, producing smaller lots that meet strict quality standards. Our cases offer reloaders excellent uniformity in wall thickness and internal capacity. We measure for consistently tight wall concentricity and even run our cases through a pressure calibration test to ensure uniform case expansion during firing. Our cases allow proper seating of the bullet, not only in the case, but in the chamber as well. High quality brass contributes to consistent charges and pressures.

RIFLE CASES	ITEM #	QTY
17 HORNET	8611	50
204 RUGER	8604	50
5.45x39	NEW 8609	50
22 HORNET	8602	50
218 BEE	8601	50
222 REM	8600	50
223 REM*	8605	50
224 VALKYRIE*	8618	50
22-250 REM*	8610	50
22 CREEDMOOR	8619	50
220 SWIFT	8615	50
223 WSSM	8617	50
243 WIN*	8620	50
6MM REM	8622	50
6MM CREEDMOOR*	86280	50
243 WSSM	86202	50
25-35 WIN	86101	50
250 SAVAGE	86105	50
25-06 REM*	86251	50
257 WBY MAG	8631	50
6.5 GRENDDEL*	86283	50
6.5X55	86263	50
260 REM	8632	50
6.5 CREEDMOOR*	86281	50
6.5-284	8628	50
6.5 PRC	86288	50
264 WIN MAG	86286	50

RIFLE CASES	ITEM #	QTY
26 NOSLER	86289	20
6.8MM REM SPC*	8629	50
270 WIN*	8635	50
270 WSM	8637	50
7-30 WATERS	NEW 86464	50
275 RIGBY	8636	50
7MM-08 REM*	8646	50
284 WIN	NEW 86406	50
280 REM	8638	50
280 ACKLEY IMP	86381	50
7MM WSM	8639	50
7MM REM MAG*	8640	50
28 NOSLER	86424	20
7MM STW	8643	50
30 CARBINE	8650	200
300 BLACKOUT*	86751	50
30-30 WIN*	8655	50
300 SAVAGE	86752	50
307 WIN	86754	50
308 MARLIN EXP	8662	50
308 WIN*	8661	50
30-40 KRAG	86627	50
30 TC	8663	50
30-06 SPRG*	8665	50
300 H&H MAG	86725	50
300 REM SA ULTRA MAG	86722	50
300 RCM	86721	50

**Also available in bulk quantities.*



RIFLE CASES	ITEM #	QTY
300 WSM	86701	50
300 WIN MAG*	8670	50
300 WBY MAG	8672	50
30 NOSLER	86706	20
300 PRC	8654	50
300 NORMA MAG	86723	20
300 REM ULTRA MAG	86724	20
30-378 WBY MAG	8658	20
7.62X39	8664	50
32-20 WIN	86726	50
303 BRITISH	8675	50
32 WIN SPL	8728	50
8X57 JRS	8644	50
8X57 JS	8648	50
338 MARLIN EXP	8721	50
338 RCM	86831	50
338 WIN MAG	8680	50
33 NOSLER	86834	20
338 NORMA MAG	86833	20
338 LAPUA MAG	8684	20
348 WIN	86841	20
350 LEGEND	NEW 87296	50
35 REM	8729	50
358 WIN	8741	50
35 WHELEN	87291	50
9.3X74R	8726	20
9.3X62	87263	50
376 STEYR	8690	50
375 FL MAG NITRO EXP	86747	20
375 RUGER	8673	50
375 H&H MAG	8685	50
450-400 NITRO EXP 3"	86934	20
416 RUGER	86871	50
416 REM MAG	86874	50
416 RIGBY	8687	20
500-416 NITRO EXP 3.25"	86877	20
404 JEFFERY	86932	20
444 MARLIN	8692	50
450 BUSHMASTER	86935	50
45-70 GOVT	8784	50
450 MARLIN	8693	50
450 NITRO EXP 3.25"	86936	20

RIFLE CASES	ITEM #	QTY
458 WIN MAG	8694	50
458 LOTT	8697	50
470 NITRO EXP 3.25"	86937	20
500 NITRO EXP 3"	86938	20
50 BMG MATCH GRADE	8772	20

PISTOL CASES	ITEM #	QTY
25 AUTO	87000	200
32 AUTO	87055	200
32 H&R MAG	NEW 8717	200
327 FEDERAL MAG	NEW 87176	200
380 AUTO*	8710	200
9MM LUGER*	8720	200
357 SIG	8739	100
38 SUPER COMP*	8734	200
38 SPL*	8730	200
357 MAG	8740	200
40 S&W*	8742	200
41 REM MAG	NEW 87411	100
44 SPL	8749	100
44 REM MAG	8750	100
45 AUTO*	8760	100
45 COLT	8780	100
454 CASULL	8785	100
460 S&W MAG	8786	50
475 LINEBAUGH	8787	100
480 RUGER	8789	100
500 S&W MAG	8790	50

**Also available in bulk quantities.*



DIGITAL CASES & PARTS DRYER

Dry hundreds of cartridge cases as well as small and large gun parts at the same time with the revolutionary Digital Cases & Parts Dryer. Four fixed trays hold cases and small parts while a fifth, adjustable tray holds larger gun parts. The unit's tall lid makes accommodating larger parts even easier.

The dryer's innovative top-mounted digital powerhead ensures that cases and parts dry thoroughly and efficiently.

- Digitally adjust drying time from 15 minutes to two hours
- Choose from seven temperature levels with digital selector
- Unit disassembles for easy cleaning

No. 053311



Case Tumblers & Accessories



ROTARY MEDIA SIFTER

Quickly separate brass cartridge cases from corn cob or steel pin tumbling media with the Rotary Media Sifter. With a few turns of the handle, media falls to the bottom of the sifter, leaving cases clean and ready to use. Sifter drum locks into place for easy loading, and clear polycarbonate lid allows easy monitoring of progress.

No. 050207



TUMBLING MEDIA

This abrasive media, made of ground corn cob, removes tarnish and other residue from cartridge cases. Use with One Shot® Metal Polish for a shiny, like-new finish.

76 oz..... No. 050303



Includes steel pin tumbling media



ROTARY CASE TUMBLER

Clean and polish brass cartridge cases to a brilliant shine with the rotary action of this tumbler, coupled with its steel pin tumbling media. Six-liter drum holds 5 pounds of brass cases. Digital timer allows tumbler to run for up to eight hours in half-hour increments. For best results, use with One Shot® Cartridge Case Solution.

No. 050220



ONE SHOT® CARTRIDGE CASE SOLUTION

Non-toxic and uniquely formulated to clean brass cases. Quickly removes most tarnish, oxidation and carbon buildup. Designed specifically for the Hornady® Lock-N-Load® Sonic Cleaners™ or stainless steel tumblers.

32 fl oz.....No. 043355
1 GallonNo. 043356





50% MORE CAPACITY THAN THE M1 CASE TUMBLER!



M-1 CASE TUMBLER

Add to the quality of your reloaded ammunition by using the M-1 Case Tumbler to clean and polish large quantities of cases quickly and efficiently. Coupled with Hornady® Tumbling Media, the cyclonic and vibratory action of the Tumbler cleans brass to a brilliant shine. Use the included sifter to separate the polished brass from the media. Running time may be varied based on the condition of the cases and degree of cleanliness desired. Holds up to (400) 38 Spl cases, (180) 30-06 Sprg cases, or the equivalent of other like-sized cases.

No. 050202

MAGNUM DIGITAL VIBRATORY TUMBLER

Clean and polish large quantities of brass to a brilliant finish before loading, eliminating abrasive foreign particles that can scratch the inside of your dies. Brass cases cleaned with vibratory action enhances the smooth function of reloading presses and dies, and makes finished reloads look like new.

- Large drum holds up to (600) 38 Spl cases, (250) 30-06 Sprg cases or equivalent.
- Digital timer allows tumbling for up to eight hours.

No. 050240



Place the included sifter over a 5-gallon bucket (not included) to separate clean brass from media.

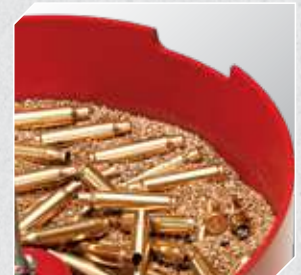

Tumbler bowl is notched for easy sifting and cleanup.

CUSTOMER FAVORITE!

ONE SHOT® CASE LUBE

One Shot® Case Lube with DynaGlide Plus® technology is a micro-penetrating high pressure dry film. It contains no petroleum, teflon or other synthetic silicone so it will not contaminate powder or primers.

5 oz. Aerosol . . No. 9991
10 oz. Aerosol . No. 99913



ONE SHOT® GUN CLEANER & LUBE

Hornady® One Shot® with DynaGlide Plus® is a revolutionary formula developed to prevent firearm malfunctions caused by a buildup of lubricants and grime.

5 oz. Aerosol . . No. 9990
10 oz. Aerosol . No. 99901



ONE SHOT® METAL POLISH

For use with Hornady Tumbling Media, this water-based, bio-degradable product cleans, polishes, and protects all metals except aluminum.

8 oz. No. 9993
(Non-hazardous)





Sonic Cleaners & Accessories

LOCK-N-LOAD® SONIC CLEANER™ 2L

Features an 80 watt ceramic heater that enhances cleaning action, which is especially helpful when cleaning gun parts. Its large 2 liter stainless steel tank holds up to three hundred 223 cases or one hundred fifty 308 cases. Combined with One Shot® Sonic Clean™ solution, its microjet action removes carbon residue and other debris from internal and external surfaces of cartridge cases, small gun parts and other small metal equipment. The cleaner's 5 to 30 minute timer allows you to choose the appropriate cycle for your application.

Tank dimensions:
7.25" x 6" x 3" (2L)

No. 043320



LOCK-N-LOAD® SONIC CLEANER™

Using a combination of intense ultrasonic cleaning action and a unique cleaning solution, this cleaner quickly removes tarnish, oxidation, and carbon buildup from the entire case, including the inside walls and primer pockets. Use it to clean gun parts and equipment as well. Holds up to two hundred 223 cases or one hundred 308 cases. 1.2L Tank.

No. 043350



ONE SHOT® CARTRIDGE CLEANING SOLUTION

Non-toxic and uniquely formulated to clean brass cases. Quickly removes most tarnish, oxidation and carbon buildup. Designed specifically for the Hornady® Lock-N-Load® Sonic Cleaners.™

32 fl oz.....No. 043355

1 GallonNo. 043356



ONE SHOT® SONIC CLEAN™ GUN PARTS FORMULA

Cleans all gun parts and is safe for all firearms finishes. Quickly removes carbon, dirt, grease and powder residue. Designed specifically for the Hornady® Lock-N-Load® Sonic Cleaners.™

32 fl oz.....No. 043360

1 GallonNo. 043361



*For best results, use
One Shot® Sonic Clean™
Solution!*

BEFORE



AFTER

CAM LOCK™ BULLET PULLER

The fastest, easiest way to pull bullets with your press. Just clamp on the bullet, pull down on the handle and the bullet is removed. INTENDED FOR RIFLE CARTRIDGES ONLY — DO NOT USE FOR PISTOL CARTRIDGES. Uses standard collets (sold separately, see chart below).

No. 050095

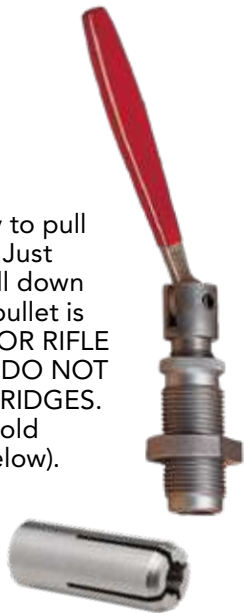

CAM LOCK™ BULLET COLLETS

Works with the Cam Lock™ Bullet Puller.

Bullet Dia.	Collet No.	Item No.	Bullet Dia.	Collet No.	Item No.
.172	1	392154	.308/.312	7	392160
.204	14	392167	.321/.323	8	392161
.223	2	392155	.338/.358	9	392162
.243	3	392156	.375	10	392163
.264/.257	4	392157	.410/.416	11	392164
.277	5	392158	.430	12	392165
.284	6	392159	.451/.458	13	392166

PRIMER POCKET REAMER

Primer Pocket Reamer Package makes cases with crimped primer pockets reloadable by cutting away the crimp. Complete with handle, large and small cutter heads. Heads also fit on Power Case Prep Center and Case Prep Trio. (See page 109.)

No. 041210

(Extra reamer heads sold separately.)

Lg. Head No. 390751
Sm. Head No. 390750



L-N-L® IMPACT BULLET PULLER **NEW**

Remove bullets from cartridges without damaging the bullets. Hollow head of bullet puller captures bullet and powder for reuse. Three collet sizes allow for use with cartridges from .22 up to .45 caliber. Collets are stored inside the handle.

No. 050092



PILOT STYLE FLASH HOLE DEBURR TOOL

Designed to deburr and uniform flash holes in cartridge cases quickly and easily, this tool uses floating pilots to guide the cutter directly toward the flash hole of the case, resulting in a clean and uniform hole every time.

No. 399693



UNIVERSAL SHELL HOLDERS

Precision machined from solid steel and heat-treated to perform flawlessly. Wide mouth and rounded edge at the opening allow smoother case insertion. A single shell holder may be used for multiple calibers.

(See chart on pages 142-148.)

DELUXE ID/OD CHAMFER/ DEBURR TOOL

Prepares cases by chamfering the inside edge and deburring the outside edge.

No. 050117

50 Cal. Deburr Tool No. 050153



HORNADY® 3-WAY CUTTER **NEW**

Trim, chamfer and deburr cartridge cases — all in one step. Four custom interchangeable caliber-specific pilots have shoulders for easy setting of interior diameter (ID) and outside diameter (OD) cutters. ID cutter with 15-degree blade and OD cutter with 30-degree blade are made of carbide for strength and durability. Just attach to your Hornady® trimmer to begin trimming.

No. 050142



4 BLADE OUTSIDE DIAMETER DEBURRING TOOL

Fits on Universal Handle, Power Case Prep Center, or Case Prep Trio. (See page 109.)

No. 050173

6 BLADE INSIDE DIAMETER CHAMFER TOOL

Fits on Universal Handle, Power Case Prep Center, or Case Prep Trio. (See page 109.)

No. 050172





Reloading Accessories



LOCK-N-LOAD® AP™ DELUXE SPENT PRIMER CATCHER

The AP Deluxe Primer Catcher fits the Lock-N-Load® AP™ Press. Decapped primers drop into the tube and travel to the bottle, where they can be collected for future disposal.

No. 050099



LOCK-N-LOAD® LIGHT STRIP

Light up your press with the Hornady® Lock-N-Load® Light Strip. With an adhesive backing, the Lock-N-Load® Light Strip can be used on any press or location on your reloading bench for extra light to help eliminate shadows, making safety and quality checks easier than ever. The Lock-N-Load® Light Strip features LED lights for a long life and plugs into a standard 110V outlet or Lock-N-Load® Control Panel.

No. 044660



QUICK DETACH RELOADING MOUNTING SYSTEM

Quickly and easily attach and detach presses and other reloading tools.

Maximizes production when bench space is limited.

Two cam locks keep plate stable during use and allow quick release for easy tool changeovers.

Mounting hole configurations fit a variety of presses including the Lock-N-Load® AP, Lock-N-Load® Iron Press, Lock-N-Load® Classic, 50 BMG and 366 Auto Shotgun Press. Also fits the Lock-N-Load® Bullet Feeders, Cam Lock™ Trimmer, Lock-N-Load® Concentricity Tool, and the Neck Turning Tool.

Quick Detach Mounting Plate System. . . No. 399697

Quick Detach Mounting Plate Only. . . . No. 399698



UNIVERSAL ACCESSORY BIN AND BRACKET

The swiveling base of this cartridge bin bracket allows for adaptability on the Lock-N-Load® AP™ and Classic™ Presses. Use it to conveniently store finished rounds.

No. 399692



LOCK-N-LOAD® PRIMER PICK-UP TUBE KITS

Stocking your reloading bench with extra primer pick-up tubes will allow you to load more rounds without stopping to refill primers. Compatible with the Lock-N-Load® AP™ and Lock-N-Load® Iron Press™

**3 Pack Large Primer Pick-Up Tube
No. 398511**

**3 Pack Small Primer Pick-Up Tube
No. 398509**

**Not compatible with 1911 Auto Primer Tube Filler*



FAST LOAD POWDER MEASURE STAND

Features a rigid frame and extra long arm that lets you fill an entire 50-count Universal Loading Block. The Lock-N-Load® bushing system accommodates any measure with 7/8"-14 thread.

No. 050008

1911 AUTO PRIMER TUBE FILLER

Shorten your primer tube filling times with this fast and fun Hornady® 1911 Auto™ Primer Tube Filler. The ergonomic handle positions the tray at an optimum angle for feeding primers and fills a 100-count primer tube in 10-15 seconds. Includes small and large trays and tubes. Batteries not included.

No. 050098



HANDHELD PRIMING TOOL

One-piece primer tray with integral molded primer bushings that eliminate the need for separate bushings. Ergonomic design reduces fatigue. Designed for easy changeovers, shell holders and primer trays can be changed without removing the spring and punch. Includes tray for RCBS® shell holders.



No. 050021

UNIVERSAL LOADING BLOCK

This double-sided block holds 50 cases and helps streamline powder charging and inspection. Fits 223, 308 and magnum case size heads. Also works with the Hornady® Fast Load Powder Measure Stand.



No. 480040

MAGNUM LOADING BLOCK

This large caliber reloading tray holds fifty 50 caliber cases or shotgun shells.



No. 480042



Case Prep Tools



STANDARD MICROMETER

This versatile instrument accurately measures in 0.0001" increments for precise readings on bullets or objects up to 1 inch in size. Spindle lock preserves measurement when removing micrometer from work piece.

No 050072



VERNIER BALL MICROMETER

With a ball anvil and chamfered spindle, the Vernier Ball Micrometer is ideal for accurately measuring case neck thickness within an accuracy of 0.0001". Ratchet stop ensures uniform pressure for measurement repeatability.

No 050059



DIAL CALIPER

Stainless steel construction with shock-resistant dial is accurate to +/- 0.001". Four-way measurement capability: inside, outside, depth and step. Slide may be locked in any position for precise measurements. Thumb wheel aids in easy opening and closing. Includes plastic storage case.

No. 050075 (inches)



DIGITAL CALIPER

Precisely measure case length, inside and outside case diameter, bullet length, primer pocket depth and overall cartridge length. Features quick repeat and measuring speed, an extra large LCD screen and accuracy to .001." Battery and protective storage case included.

No. 050080 (inches/metric)



STUCK CASE REMOVER

Easily remove stuck cases from dies by drilling and tapping the stuck case. Consists of #7 drill bit and 1/4 inch-20 tap.

No. 050033

UNIQUE™ CASE LUBE

For those who want to use a high quality paste lube, this non-petroleum product will not contaminate powder or primers.

No. 393299



ONE SHOT® CASE SIZING WAX

Simply dab on your index finger and thumb, then apply to cartridge case before sizing.

No. 9989



GO/NO-GO CARTRIDGE GAUGE

Hornady Lock-N-Load® Cartridge Gauges allow the user to check their cases and ammo to ensure a correct fit in SAAMI chambers. Available in a variety of calibers.



Description	Item No.
380 Auto (.355)	380700
9mm Luger (.355)	380701
38 Spl (.357)	380702
357 Magnum (.357)	380703
40 S&W (.400)	380704
44 Rem Mag (.430)	380705
45 Auto (.451)	380706
223 Rem (.224)	380707
22-250 Rem (.224)	380708
243 Win (.243)	380709

Description	Item No.
6.5 Creedmoor (.264)	380710
270 Win (.277)	380711
7mm-08 Rem (.284)	380712
7mm Rem Mag (.284)	380713
300 Blackout (.308)	380714
30-30 Win (.308)	380715
308 Win (.308)	380716
30-06 Sprng (.308)	380717
300 Win Mag (.308)	380718



PRECISION MEASUREMENT STATION **NEW**

Precision reloaders know the most consistent cartridges are built with the most consistent components. The Hornady® Precision Measurement Station allows the reloader to sort components according to size and quality. It also compares bullet ogive location, headspace location, and overall case length. Measure bullet runout for true cartridge case concentricity, and identify inconsistencies such as case and bullet dents. Base weighs nearly 8 pounds and has leveling feet for stability. Tool includes five bushings, seven bullet containment comparators, 0.0005" increment dial indicator and accessory mount.

No. 050078

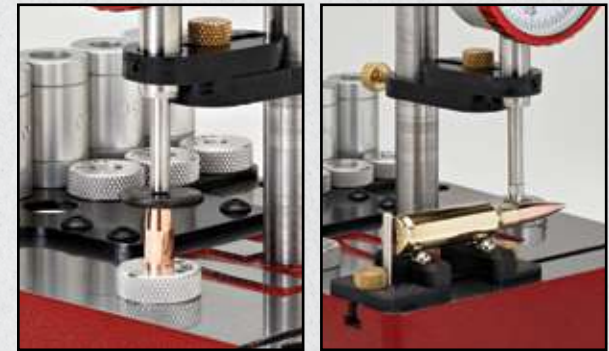

CASE PREP DUO

Make quick work of various reloading chores with this cordless, rechargeable multifunction tool that accommodates case neck brushes, primer pocket cleaners, and chamfer/deburr accessories. With the easy to swivel body and integrated rubber feet, use it in the straight configuration on your bench top, or rotate it 180 degrees for an ergonomic handheld power tool. Use with the 8-32 spindle head for various reloading functions or remove the spindle head and use as a powered screwdriver with standard 1/4-inch hex bits (not included). Comes with plug-in charger, ID and OD chamfer tools.

No. 050180



**GET LOADED!
FREE BULLETS
WITH PURCHASE!
— SEE PAGE 93 —**

SINGLE STAGE PRIMER POCKET SWAGE TOOL

Quickly and cleanly removes crimps on cartridge case primer pockets. Swage depth can be adjusted to accommodate various case brands. Swaging out the crimps on primer pockets instead of cutting them eliminates trimmings and mess.

223/5.56 ONLY No. 041227
308/7.62X51 ONLY No. 041228



QUICK CHANGE HAND TOOL

Features a dual-sided chuck that allows for the quick changeover of popular case preparation tools. Includes 3 dual-sided chucks, chamfer/deburr tools, large and small primer pocket cleaners and neck brushes for the following calibers: 22 cal, 25 cal/6mm, 270 cal/7mm, 30 cal, 35 cal/9mm and 45 cal.

No. 050097





Case Prep Tools



NECK TURN TOOL

The Hornady® Neck Turn Tool saves handloaders time and effort at the workbench. Designed for use on a wide variety of case lengths, the Hornady® Neck Turn Tool allows for the use of a drill (not included) to make neck turning faster and easier, while providing superior consistency and surface finish.



An adjustment knob enables the user to choose detents for .0005" adjustment increments, or no detents for infinite adjustment. The mandrels for four popular calibers are included: 22 Cal., 6mm, 6.5mm & 30 Cal. Two cutters are also included: 30° and 40° shoulder angles.

The Hornady® Neck Turn tool is a winning solution for precision handloaders who want to maximize accuracy. **No. 041224**

MANDRELS

Caliber	Dia.	Item No.	Caliber	Dia.	Item No.
17 Cal.	.1690	391908	7mm	.2813	391924
20 Cal.	.2010	391909	30 Cal.*	.3055	391928
22 Cal.*	.2210	391910	8mm	.3205	391929
6mm*	.2395	391913	338 Cal.	.3355	391930
25 Cal.	.2545	391915	35 Cal.	.3555	391931
6.5mm*	.2615	391919	375 Cal.	.3725	391932
270 Cal.	.2750	391921			

* = included with Neck Turn Tool

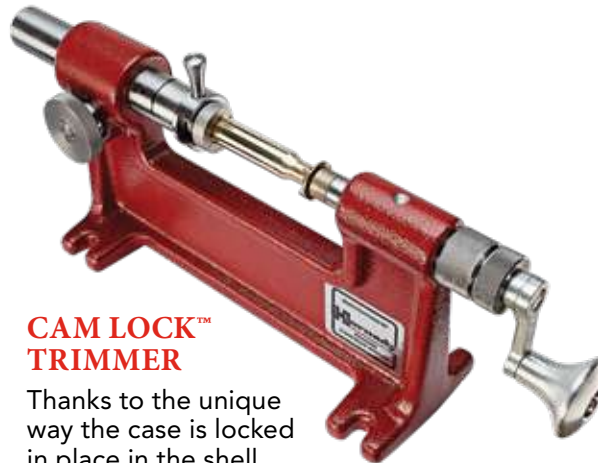

CAM LOCK™ TRIMMER

Thanks to the unique way the case is locked in place in the shell holder, this trimmer accurately restores fired cases to the correct length no matter the thickness of the cartridge rim. The lever locks the case in place. The Micro Adjust cutter allows .001" changes without moving the case (extra cost on competitor trimmers). Plus, its large diameter, replaceable cutting head is made of ultra-hard tool steel and trims cases up to 50 caliber. Use only standard Hornady® shell holders and pilots. Includes ten of the most popular pilot sizes: 22 cal, 6mm, 25 cal, 6.5mm, 270 cal, 7mm, 30 cal, 35 cal, 38 cal, and 45 cal.



Choose your shell holder and trimmer pilots from the charts on pages 142-148.

- Cam Lock™ Trimmer** **No. 050140**
- Cam Lock™ Power Trimmer Adapter** **No. 050145**
- Cam Lock™ Trimmer Dust Cover** . . . **No. 100016**
- 17 Cal. Trimmer Pilot/Cutter** **No. 390942**
- Hornady® 3-Way Cutter** **No. 050142**



LOCK-N-LOAD® CONCENTRICITY TOOL

This tool identifies and eliminates bullet runout (or wobble). Just place ammunition in the tool, roll it, identify runout and use the dial indicator thumbscrew to adjust. Provides improved accuracy for handloaders, and can be used to true up factory ammo too.

No. 050076

NECK WALL THICKNESS GAUGE

This accessory to the Concentricity Tool offers the next step in ultra-precision reloading. Its .0005" increment dial indicator helps identify neck thickness variations so you can sort and measure case necks or verify your neck turning operation – ultimately enhancing accuracy. (Concentricity Tool not included.)



No. 041223

CAM LOCK™ CHAMFER/DEBURR TOOLS

Mounts in place of the cutter to speed the chamfering and deburring process. It also keeps chamfers and deburrs square with the case mouth. **No. 050147**



LOCK-N-LOAD® ATTACHMENT ADAPTER

Use with your power drill for your case prep needs.

No. 399671



LOCK-N-LOAD® CASE PREP TRIO

Speed up your case prep process with the 3-tool capacity and utilize the onboard storage for optional accessories like our primer pocket cleaners, primer pocket reamers, case neck brushes and any other 8-32 thread tools.

With three active stations, you can chamfer, deburr and clean primer pockets without having to change tools. The Lock-N-Load® Case Prep Trio comes with both inside and outside chamfer and deburr tools. **Made in the U.S.A.**

No. 050160

Optional accessories for the Case Prep Trio or Power Case Prep Center

Large Caliber Chamfer (45+ Cal. ID)	No. 050170
Large Caliber Deburr (45+ Cal. OD)	No. 050171
Small Caliber Chamfer (17-45 Cal.)	No. 050172
Small Caliber Deburr (17-45 Cal.)	No. 050173
Small Pocket Uniformer	No. 041212
Large Pocket Uniformer	No. 041211
Small Primer Pocket Reamer	No. 390750
Large Primer Pocket Reamer	No. 390751
Small Primer Pocket Cleaner Head	No. 390752
Large Primer Pocket Cleaner Head	No. 390753

CASE NECK BRUSHES

SIZE	ITEM NO.	SIZE	ITEM NO.
17 Cal.	380062	30 Cal.	380067
22 Cal.	380063	35 Cal.	380068
6mm/25 Cal./6.5mm	380065	45 Cal.	380069
270 Cal./7mm	380066		

LOCK-N-LOAD® POWER CASE PREP CENTER

The Lock-N-Load® Power Case Prep Center saves reloaders time and bench space by rolling all the necessary case prep functions into one unit. Its all-in-one versatility combines a power trimmer with chamfer/deburr tools, large and small primer pocket cleaners, six popular neck brush sizes (22 cal, 6mm/25 cal/6.5mm, 270 cal/7mm, 30 cal, 35 cal and 45 cal) and pilots in same calibers. Also includes shell holders 1, 2, 5, 16 and 35.

FEATURES

- The trimmer is micro adjustable to .001" for precise and consistent trimming.
- Rugged housing and a powerful motor will give years of dependable service.
- Trims small to large cases measuring ¾" to 3¼ in length."
- Innovative design keeps metal shavings in the catch trays and out of the cases.
- Easy grip handle offers leverage.
- Arrange the chamfer/deburr tools, primer pocket cleaners and neck brushes however you want on the front panel.

Use with Hornady® shell holders and trimmer pilots only.

Optional flash hole deburr tool, primer pocket reamer, primer pocket uniformer and additional neck brushes can be purchased separately.

No. 050012



UNIVERSAL TRIM LENGTH GAUGE

Use this tool to set the case overall length on the Case Prep Center. May be used with 11 popular calibers from the 6.5 Grendel to the 375 H&H Mag, both fired and resized cartridge cases.

No. 050149

**DOWNLOAD THE
NEW HORNADY®
RELOADING
MOBILE APP!**



ACCESS ALL THE FEATURES OF OUR CLASSIC RELOADING HANDBOOK ON YOUR MOBILE DEVICE.

NEW

The Hornady® Handbook of Cartridge Reloading — the most comprehensive and trusted reloading reference for decades — is now available in app form! Like the bound and eBook versions, the new Hornady® Reloading App provides everyone from the novice to the seasoned handloader everything needed to successfully reload a variety of rifle cartridges from the 17 Hornet to the 50 BMG and handgun cartridges from the 22 Hornet to the 500 S&W Mag.

HUNDREDS OF CALIBERS

More than 200 calibers with a variety of loads featuring Hornady bullets, such as the ELD-X® and ELD® Match lines.

EASY-TO-USE VELOCITY AND POWDER CHARTS

Velocity and powder charts included with each cartridge for easy reference. You'll find an impressive lineup of powders including Power Pro 2000 MR; IMR 4451 and 7977; CFE Pistol; BE-86; Reloader 23, 26, 33 and 50; Accurate LT-30 and 32; and some offerings from Shooters World. Popular established powders like Reloader 17, Superformance® and LeverEvolution® have also been expanded to more cartridges.

HISTORICAL INFORMATION

Details on the history of numerous cartridges.

BULLET SELECTION HELP

Information on bullet design and shooting application to help with selection.

RANGE LOGS AND FAVORITES

The ability to save information from the range and favorites within the app.

Reloading Manual & Ballistic Calculator



10th Edition Hornady® Handbook of Cartridge Reloading

- Featuring over 1,000 pages of reloading data, techniques and bullet information.
- Over 200 different calibers featuring a variety of loads using Hornady® bullets.
- An impressive lineup of new and expanded data that incorporates new powders, and new bullets like the ELD-X® and ELD® Match.
- New cartridge additions like the 280 Ackley Improved, 7 x 64 Brenneke and the 338 Federal.
- Well over 1,300 load combinations were shot to update and expand the reloading pages in this edition.

No. 99240

HORNADY® HANDBOOK OF CARTRIDGE RELOADING EBOOK EDITIONS

For those who prefer the convenience and searching ease of an eBook, Hornady® offers a download of the Reloading Manual from iTunes. Having an electronic version allows a more compact format that you can take anywhere!

Search iTunes book store or Kindle store



FREE BALLISTIC APP WITH 4DOF®

The free Hornady Ballistic Calculator App includes the advanced 4DOF® calculator as well as a standard BC calculator. Providing more accurate trajectory solutions, the 4DOF® calculator incorporates the projectile's movement in the standard 3 degrees but also adds its movement about its center of gravity and subsequent angle relative to its line of flight, which is the fourth degree of freedom.

- Calculates more accurate trajectories, especially at extreme ranges
- Can be used without wireless connectivity
- Pre-populated with long range match and hunting style bullets

Using Doppler radar, Hornady engineers calculated exact drag versus velocity curves for each bullet in the 4DOF® database. Combined with the physical attributes of the projectiles, the 4DOF® calculator is simply more accurate for long-range hits than using BC-based systems or drag curves based on limited data collection points.



4DOF® available on the
Hornady® Kestrel® 5700
Ballistics Weather Meter



Lock-N-Load® Precision Gauges

LOCK-N-LOAD® O.A.L. GAUGES

STRAIGHT MODEL – For bolt-action and single-shot firearms, or any firearm with straight-line access to the chamber. This model is preferred, as it is most precise and user friendly.

No. C1000

CURVED MODEL – For autoloader, lever-action, or pump-action rifles. Also fits all bolt-action and single-shot firearms. Inserts into chamber through ejection port.

Not compatible with Adapter "D" or short-bodied cases.
(See chart below)

No. C1550

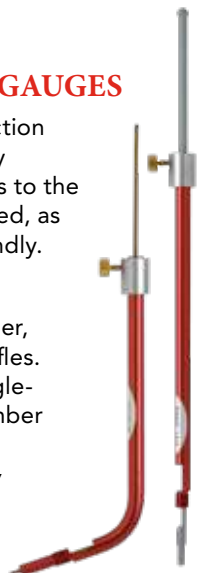

ACHIEVE PRECISE BULLET SEATING DEPTH.

Regulating seating depth and the resulting "jump" to the rifling is widely regarded as fundamental to improved accuracy. A few thousandths of an inch change between the bullet and the rifling can make the difference between average accuracy and real tack-driver performance. The Lock-N-Load® O.A.L. Gauge is universally acclaimed as the most accurate, easy-to-use and reliable method of obtaining that critical relationship.

To use the Lock-N-Load® O.A.L. Gauge, you will need a Modified Case (sold separately) to fit your firearm's chamber and thread it onto the gauge. These specially prepared modified cases are threaded at the case-head and have a .002" oversized neck to accept the same bullets you intend to load. This is critical, as the Lock-N-Load® O.A.L. Gauge dimensions obtained will be accurate to .001". These results cannot be attained with competitive products, which use a simulated bullet with an arbitrary shape.



LOCK-N-LOAD® MODIFIED CASES

Lock-N-Load® Modified Cases are readily available to fit most popular rifle chambers. All are manufactured to SAAMI specs.

Modified Case and Adapter D for 22 Hornet No. D1202

CUSTOM CASE MODIFICATION

Any of your brass, including all wildcat sizes, can be custom modified at our factory for use with either gauge. Simply send us two fired cases by mail for quick turnaround (visit our website for details).

MODIFIED CASES "A" SERIES	
ITEM NO.	DESCRIPTION
A17	17 REM
A218	218 BEE
A221	221 REM FIREBALL
A222	222 REM
A223	223 REM
A222M	222 REM MAG
A224	224 VALKYRIE
A22250	22-250 REM
A220	220 SWIFT
A6MMB	6MM BR REM
A243	243 WIN
A6MM	6MM REM
A6MMC	6MM CREEDMOOR
A250	250 SAVAGE
A257	257 ROBERTS
A2506	25-06 REM
A65G	6.5 GRENDDEL
A260	260 REM
A65C	6.5 CREEDMOOR
A264	264 WIN MAG
A68SPC	6.8MM REM SPC
A270	270 WIN
A7X57	7X57
A7MM08	7MM-08 REM
A280	280 REM
A280AI	280 ACKLEY IMP

MODIFIED CASES "A" SERIES	
ITEM NO.	DESCRIPTION
A7MMR	7MM REM MAG
A300A	300 BLACKOUT
A3030	30-30 WIN
A308ME	308 MARLIN EXPRESS
A308	308 WIN
A30TC	30 TC
A3006	30-06 SPRG
A300H	300 H&H MAG
A300R	300 RCM
A300M	300 WIN MAG
A300W	300 WBY MAG
A762	7.62X39 (.308-.311)
A303	303 BRITISH
A32	32 WIN SPL
A8X57	8X57 (J5)
A8MM	8MM REM MAG
A338M	338 MARLIN EXPRESS
A338R	338 RCM
A338	338 WIN MAG
A340	340 WBY MAG
A350L	350 LEGEND NEW
A35R	35 REM
A350	350 REM MAG
A35	35 WHELEN
A9362	9.3X62
A375	375 H&H MAG

MODIFIED CASES "A" SERIES	
ITEM NO.	DESCRIPTION
A416	416 REM MAG
A450B	450 BUSHMASTER
A4570	45-70 GOVT

MODIFIED CASES "B" SERIES	
ITEM NO.	DESCRIPTION
B204	204 RUGER
B22C	22 CREEDMOOR
B223	223 WSSM
B6PPC	6MM PPC SAKO
B240	240 WBY MAG
B243	243 WSSM
B25	25 WSSM
B257	257 WBY MAG
B65X55	6.5X55
B65	6.5-284
B65P	6.5 PRC
B26N	26 NOSLER NEW
B270W	270 WSM
B270	270 WBY MAG
B764	7X64
B7MMR	7MM REM SA ULTRA MAG
B7WS	7MM WSM
B7MMW	7MM WBY MAG
B28N	28 NOSLER NEW

MODIFIED CASES "B" SERIES	
ITEM NO.	DESCRIPTION
B7MM	7MM REM ULTRA MAG
B300S	300 SAVAGE
B300R	300 REM SA ULTRA MAG
B300W	300 WSM
B30N	30 NOSLER NEW
B300P	300 PRC
B300	300 REM ULTRA MAG
B33N	33 NOSLER NEW
B338	338 REM ULTRA MAG
B358	358 WIN
B378	378 WBY MAG

MODIFIED CASES "C" SERIES	
ITEM NO.	DESCRIPTION
C30378	30-378 WBY MAG
C338L	338 LAPUA MAG
C9374	9.3X74R
C375R	375 RUGER
C405	405 WIN
C416R	416 RIGBY
C458W	458 WIN MAG
C458L	458 LOTT
C50BMG	50 BMG



LOCK-N-LOAD® HEADSPACE COMPARATOR

The Lock-N-Load® Headspace Comparator extends brass life, improves accuracy, and enhances safety. The gauge measures variations in brass before and after firing or re-sizing. It allows for headspace comparison between fire-formed brass and re-sized brass.

The five bushings that come with the Lock-N-Load® Headspace Comparator provide the ability to check most bottleneck cases, from .17 Rem through belted magnums. Ackley Improved chambers use the same bushing size as the parent case. See chart provided or consult product instructions for cartridge/bushing size details.

Body with 5 Bushing Set No. HK66
5 Bushings Only No. HK55



Determining the proper bushing diameter:
 If you add the neck diameter and the shoulder diameter and divide that number by two, use the bushing closest to that number.

LOCK-N-LOAD® HEADSPACE BUSHINGS

G .240" No. G240	A .330" No. A330	B .350" No. B350	C .375" No. C375	D .400" No. D400	E .420" No. E420	F .188" No. F188
17 Hornet	.17 Rem	22PPC	6mm Rem	300 H&H	223 WSSM	Bushing "blank" with .188" diameter hole. Drill and Ream for sizes not listed.
	204 Ruger	22-250 Rem	257 Rob	7.62x39	243 WSSM	
	221 FB	6PPC, 6BR Rem	25-06 Rem	6.5x55	260 Rem	
	222 Rem	250 Sav	270 Win	7mm WSM	270 WSM	
	222 Rem Mag	7BR Rem	7 x 57mm	30-40 Krag	7mm-08 Rem	
	223 Rem	300 Blkout	280 Rem	6.5 Creedmoor	300 Sav	
	220 Swift	6.5 Grendel	30-30 Win	6.5 x47 Lapua	308 Win	
			30-06		35 Rem	
					243 Win	
					325 WSM	
					338 Win Mag	
					350 Rem Mag	
					375 H&H Mag	
					264 Win Mag	
					7mm SAUM	
					7mm Rem Mag	
					7mm STW	
					300 RSAUM	
					300 Win Mag	
					300 Ultra Mag	
					8mm Rem Mag	
					338 Ultra Mag	
					35 Whelan	



LOCK-N-LOAD® 17-22 RIM THICKNESS GAUGE

Sorting ammo by rim thickness will provide ammo with similar ignition qualities for improved accuracy. This proven technique is used by competitive shooters and varmint hunters. The rimfire gauge attaches to your caliper and includes bushings for use with most .17 and .22 caliber rimfire ammo. (Not compatible with 17 WSM.)

No. RF17



ANVIL BASE KIT

The anvil attaches to the opposite blade of your caliper when utilizing the Hornady® Lock-N-Load® Headspace Comparator, supplying a large surface area for case heads and bullets to rest, making ogive and headspace measurements easier to obtain.

No. AB1



LOCK-N-LOAD® BULLET COMPARATOR

Measuring cartridge lengths across the bullet tips is not a reliable (or repeatable) method for measuring loaded rounds. It's common for variations of up to .025" to exist from one round to the next. Our Bullet Comparator measures rounds from the ogive to provide consistent, precise measurements. You can also use it to check uniformity of bullets from base to ogive.

Our Bullet Comparator easily attaches to the blade of your caliper and uses interchangeable inserts (available in sizes from .17 caliber to .45 caliber) to measure from the bullet ogive.

Used in conjunction with the O.A.L. Gauge, the Bullet Comparator provides the ultimate in precision measurement. The Bullet Comparator will properly align the O.A.L. Gauge for precise measurement using a caliper. This method allows direct comparison of your loads as you set up your bullet seating die for any selected bullet free-travel (jump).

Bullet Comparator – Basic Set No. B234

Comparator body and 7 bullet inserts for bullet diameters: .224" (5.56mm), .243" (6mm), .257," .264" (6.5mm), .277," .284" (7mm), .308" (7.62 & 8mm)

Bullet Comparator – Complete Set No. B14

Comparator body and all 14 bullet inserts for bullet diameters: .172," .204," .224" (5.56mm), .243" (6mm), .257," .264" (6.5mm), .277," .284" (7mm), .308," .338," .358," .375," .416," .458"



Custom Grade™ Dies

FULL-LENGTH SIZING DIE

① Zip Spindle™ Design

A feature on all full length size dies, the Zip Spindle™ positively locks to eliminate slippage. A series of light threads cut on both the spindle and spindle collet allows incremental adjustments by turning the spindle or it can easily “zip” up or down for larger movements.

② Smooth Finish

Internal die profile is precision machined and polished to a smooth finish for reliable functioning without case sticking or excessive friction. Most of our pistol dies feature a titanium nitride “gold ring” finish that’s harder than carbide and doesn’t require lubrication. The super hard coating is perfect for resizing soft pistol brass and won’t scratch cases.

③ Lock Rings with Wrench Flats

The Hornady Sure-Loc™ lock rings clamp around the entire die applying constant pressure to hold the ring in place. The locking screw tightens the ring without coming into contact with the threads, eliminating possible damage from pliers.

④ Elliptical Expander

Superior to “ball expanders,” this Hornady® exclusive provides extremely smooth neck sizing and significantly reduces friction and case neck stretch. Internal threading prevents it from pulling loose and the elliptical expander eliminates the need for a separate expander die for necking-up to the next caliber.

⑤ Seater Adjustment Screw

Seater adjustment screw easily adjusts for bullet seating depths.

⑥ Compression Lock

This o-ring provides the necessary tension to make fine adjustments easier, and keep the die set in place.

⑦ Retainer Ring

Locking retainer ring removes in seconds for easy disassembly and cleaning of the die.

⑧ In-line Bullet Seating System

Our seating system holds the bullet, the case neck and the seating stem in perfect alignment in the sleeve BEFORE the bullet enters the neck of the case. The system includes a floating bullet alignment sleeve, a floating steel seating stem and a built-in crimper for benchrest precision. Bullets are aligned in the sleeve as they enter the die for optimum seating and enhanced accuracy.

⑨ Built-in Crimper

The built-in crimper allows roll crimping without the need for an extra crimp die, saving a station on your press.

⑩ Taper Crimp/Seating Die

The intuitive design of this die allows seating and taper crimping to be completed in one step, eliminating the need for a separate taper crimp die. Available in 9MM, 40 S&W & 45 Auto.

⑪ Taper Crimp Adjust Screw

Easily adjusts amount of crimp on the cartridge without changing bullet seating depth or loosening the lock ring.

⑫ Expander Dies

These dies put a consistent slight “bell” or flare on straight-walled rifle or pistol case mouths. They prepare the case so powder and bullet insertion are smoother.

⑬ Straight Wall Sizing Dies

Most of our straight wall sizing dies feature a titanium coated sizing ring (gold ring). This eliminates case sticking and requires no lubrication. The super hard, smooth coating is used in high-pressure, high-wear tools to reduce abrasion, so it’s perfect for resizing relatively soft pistol brass, and won’t scratch your cases. Less friction means less wear on cases for longer case life. Spindle locks in place with collet lock for positive decap and easy adjustment.

**For a full list of available dies,
see the charts on pages 142-148.**

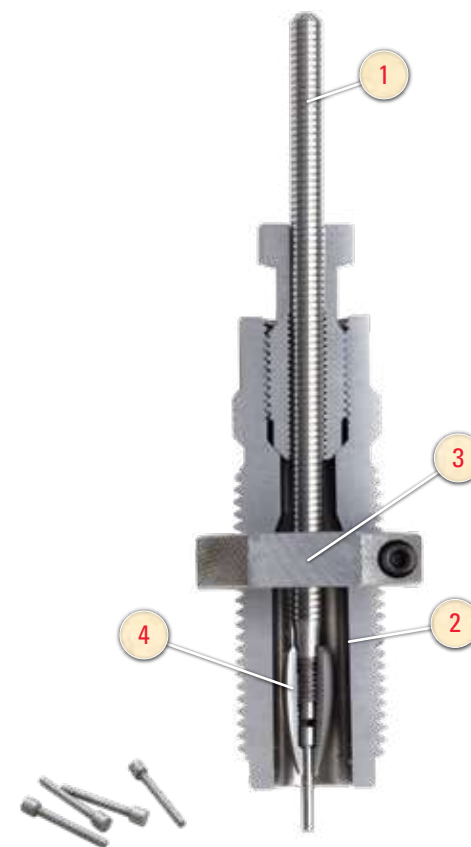

The replaceable decap pin is unique to Hornady® Dies.

**GET LOADED!
FREE BULLETS
WITH PURCHASE!
— SEE PAGE 93 —**



Match Grade™ Dies

- ① **Self-Centering Spindle**
Free-floating spindle design ensures precise, concentric neck expansion.
- ② **Knurled spindle lock**
Provides easy adjustment of decapping features.
- ③ **Spindle adjust with O-Ring**
Provides slight tension for fine adjustments, and holds setting once in place.
- ④ **Bushing (sold separately)**
Available in .001" increments, these bushings fully eliminate neck resizing problems. Tight tolerances here translate into tighter groups.
- ⑤ **Replaceable Headed Decap Pin**
The replaceable decap pin is unique to Hornady® Dies.
- ⑥ **Elliptical Expander**
Our Match Grade™ Dies ship with both an elliptical expander and a replaceable decap pin retainer, allowing more versatility for user preference.
- ⑦ **Micro-just Seating Micrometer**
Measures .001" adjustments for bullet seating depths.
- ⑧ **In-line Bullet Seating System**
Floating seating stem holds bullet in alignment before the bullet enters the neck of the case.

FULL-LENGTH SIZING DIE



The replaceable decap pin is unique to Hornady® Dies.

SEATING DIE WITH MICROJUST SEATING MICROMETER





Hornady® Match Grade™ Dies give you total control over neck tension when resizing. These dies feature the ability to use interchangeable, self-centering neck size bushings that eliminate the chance of over sizing your case necks and overworking the brass.* Tight tolerances at the press translate into tighter groups at the range. See below for a listing of available dies and bushings.

GET LOADED!
FREE BULLETS
WITH PURCHASE!
 — SEE PAGE 93 —

***Bushings sold separately.**

What makes Hornady® dies better?

Hornady® reloading dies represent the finest in machined craftsmanship. Precise machining allows accurate reloading by offering easier adjustments, better alignment and smooth functioning. With one of the finest internal finishes in the industry, Hornady® Custom Grade and Match Grade Dies provide a lifetime of reloading. They're so well crafted that they will never break or wear out from normal use.

MATCH™ GRADE DIE SETS

Cartridge	Item No.	Cartridge	Item No.	Cartridge	Item No.
223 REM (.224)	544207	6.5-284 NORMA (.264)	544295	300 WSM (.308)	544353
6MMX47 LAPUA (.243)	544610	6.5 PRC (.264)	544283	300 WIN MAG (.308)	544351
6MM PPC (.243)	544241	284 WIN (.284)	544303	300 PRC (.308)	544349
6MM BR REM (.243)	544249	280 ACKLEY IMP (.284)	544323	300 NORMA MAG (.308)	544371
6MM CREEDMOOR (.243)	544247	7MM REM SA ULTRA MAG (.284)	544311	300 REM ULTRA MAG (.308)	544367
6.5X47 LAPUA (.264)	544650	7MM REM MAG (.284)	544325	338 NORMA MAG (.338)	544397
6.5x55 (.264)	544281	7MM WSM (.284)	544329	338 LAPUA MAG (.338)	544399
260 REM (.264)	544277	308 WIN (.308)	544355		
6.5 CREEDMOOR (.264)	544655	30-06 SPRG (.308)	544339		

See the full list of available dies on pages 142-148.



SELECT THE BUSHING YOUR CARTRIDGE REQUIRES

22 Cal.		6mm		6.5mm		7mm		30 Cal.		338 Cal.	
Diameter	Item No.	Diameter	Item No.	Diameter	Item No.	Diameter	Item No.	Diameter	Item No.	Diameter	Item No.
.242	594242	.256	594256	.284	594284	.306	594306	.329	594329	.362	594362
.243	594243	.257	594257	.285	594285	.307	594307	.330	594330	.363	594363
.244	594244	.258	594258	.286	594286	.308	594308	.331	594331	.364	594364
.245	594245	.259	594259	.287	594287	.309	594309	.332	594332	.365	594365
.246	594246	.260	594260	.288	594288	.310	594310	.333	594333	.366	594366
.247	594247	.261	594261	.289	594289	.311	594311	.334	594334		
.248	594248	.262	594262	.290	594290	.312	594312	.335	594335		
.249	594249	.263	594263	.291	594291	.313	594313	.336	594336		
.250	594250	.264	594264	.292	594292	.314	594314	.337	594337		
.251	594251	.265	594265	.293	594293	.315	594315	.338	594338		
		.266	594266								
		.267	594267								
		.268	594268								
		.269	594269								
		.270	594270								



HORNADY MATCH GRADE DIE SETS COME COMPLETE WITH THE FOLLOWING:

- Full Length Bushing Style Die
- In-line Bullet Seating Die with Micro-just Seating Micrometer
- Elliptical Expander
- Decap Pin Retainer
- Standard Bullet Seating Stem
- Custom ELD® Match Bullet Seating Stem



Custom Dies

Manufactured to the customer's specifications.

Hornady® Manufacturing offers the advantage of making custom dies to your specifications. These custom-manufactured dies are available in either our Custom Grade™ or Match Grade™ die configuration, and can be made to load any cartridge.

Our custom-manufactured dies are made on precision CNC machines that produce extremely tight tolerances. They are designed from your chamber reamer drawing and/or three fired or parent cases, assuring a die that is a true match to your chamber.

Each custom-manufactured die is hand-crafted and polished for an unmatched finish. Elliptical expanders, shell holders, shell plates, trimmer pilots, bullet seating stems and alignment sleeves can be made to fit any bullet of any profile, lead or jacketed. These precision dies give the handloader more control over the loading process.

2-DIE SET	
Case Length	Description
2.60" or less	Full-Length Die Set Neck Size Die Set
2.601" to 2.999"	Full-Length Die Set Neck Size Die Set
3.00" or more	Full-Length Die Set Neck Size Die Set
2-DIE SET MATCH GRADE	
Case Length	Description
2.60" or less	Full-Length Die Set Neck Size Die Set
2.601" to 2.999"	Full-Length Die Set Neck Size Die Set
3.00" or more	Full-Length Die Set Neck Size Die Set
3-DIE SET	
Case Length	Description
2.60" or less	
2.601" to 2.999"	
3.00" or more	
4-DIE SET	
Description	
Handgun	
RADIUS SHOULDER DIES	
Description	
2.60" or less	
2.601" to 2.999"	
3.00" or more	

SINGLE FORM DIE	
Case Length	Description
2.60" or less	Form Die Form Die with Reamer File Type Trim Die
2.601" to 2.999"	Form Die Form Die with Reamer File Type Trim Die
3.00" or more	Form Die Form Die with Reamer File Type Trim Die

SINGLE CUSTOM DIE	
Case Length	Description
2.60" or less	Neck Size Die Full-Length Die Expander Die Bullet Seating Die Taper Crimp Die Body/Shoulder Bump Neck/Shoulder Bump Match Grade FL Size Match Grade Neck

Prices based on 7/8" x 14 die stock.
 Note: For case diameters over .585" call for price. Non-standard bullet diameters must to each die.
 Call for delivery and lead times. Payment due at time of order.
 No returns or cancellations.
 1" x 14 Dies - call for price
 1 1/4" x 12 Dies - call for price
 1 1/2" x 12 Dies - call for price

SINGLE CUSTOM DIE	
Case Length	Description
2.601" to 2.999"	Neck Size Die Full-Length Die Expander Die Bullet Seating Die Taper Crimp Die Body/Shoulder Bump Neck/Shoulder Bump Match Grade FL Size Match Grade Neck
3.00" or more	Neck Size Die Full-Length Size Die Expander Die Bullet Seating Die Taper Crimp Die

HYDRAULIC FORM DIE KIT	
Description	
2.60" or less	
2.601" to 2.999"	

CUSTOM ACCESSORIES	
Description	
AP Shell Plate	
Universal Shell Holder	
Case Trimmer Pilot	
Elliptical Expander	
Custom Mandrel under .375"	
Neck-Turning Mandrel over .375"	
Bullet Seating Stem	
Bullet Alignment Sleeve	

What you'll need to order a custom-made die:

- ✓ Cartridge Name
- ✓ Bullet Diameter
- ✓ Parent Case
- ✓ Three (3) Fired Cases
- ✓ Chamber Reamer Drawings
- ✓ Die Marking
(Up to 12 characters including spaces)

HYDRAULIC FORM DIE KIT

Our Hydraulic Form Die Kit is designed to expand a standard case into an improved case design without having to fireform cases. Saves time, bullets, powder, primers and barrel wear.



BEFORE

AFTER

Custom Bullet Seating Stems



CUSTOM BULLET SEATING STEMS

These seating stems are designed to fit Hornady® Custom Grade™ Dies, and are machined to fit the profile of specific bullets to seat them as precisely as possible without damaging bullets. (Not compatible with other manufacturers' dies.)



A-Tip™ Match Seating Stems	Item No.
22 Cal. .224" 75/80/88/90 gr. NEW	397100
6mm .243" 110 gr. NEW	397139
6.5mm .264" 135/153 gr. NEW	397138
7mm .284" 166 gr. NEW	397141
7mm .284" 190 gr. NEW	397142
30 Cal. .308" 176 gr. NEW	397143
30 Cal. .308" 230/250 gr. NEW	397140
338 Cal. .338" 300 gr. NEW	397144

ELD® Match Seating Stems	Item No.
22 Cal. .224" 75/80/88/90 gr.* NEW	397100
6mm .243" 108 gr.*	397103
6.5mm .264" 130/140 gr.*	397106
6.5mm .264" 147 gr.	397130
7mm .284" 162 gr.*	397107
7mm .284" 180 gr.	397112
30 Cal. .308" 155/168/178 gr.*	397108
30 Cal. .308" 208 gr.*	397109
30 Cal. .308" 225 gr.	397111
338 Cal. .338" 285 gr.*	397110

*Also compatible with A-MAX® bullets.

ELD-X® Seating Stems	Item No.
25 Cal. .257" 110 gr.	397136
6.5mm .264" 143 gr.	397130
270 Cal. .277" 145 gr.	397135
7mm .284" 150/162 gr.	397131
7mm .284" 175 gr.	397132
30 Cal. .308" 178/200/220 gr.	397133
30 Cal. .308" 212 gr.	397134
338 Cal. .338" 230 gr.	397137
338 Cal. .338" 270 gr. NEW	397110

FTX® Seating Stems	Item No.
30 Cal. .308" 160 gr. (30-30 Win)	397115
35 Cal. .358" 200 gr. (35 Rem)	397116
44 Cal. .430" 265 gr. (444 Marlin)	397117
45 Cal. .452" 200 gr. (460 S&W Mag)	397118
45 Cal. .452" 250 gr. (450 Bushmaster)	397119
45 Cal. .458" 325 gr. (45-70 Govt)	397120
50 Cal. .500" 300 gr. (500 S&W Mag)	397121

MonoFlex® Seating Stems	Item No.
30 Cal. .308" 140 gr. (30-30 Win)	397115
45 Cal. .458" 250 gr. (45-70 Govt)	397120





Individual Dies & Accessories

UNIVERSAL DECAPPING DIE

Universal decapping die to decap military cases that have swaged primer pockets and are hard on conventional sizing/decapping dies.

No. 050085



MICROJUST™ SEATING MICROMETER

Add the MicroJust™ to a Custom Grade Hornady® seating die, and you can precisely set bullet seating depth in .001" increments. It's a quick and easy way to achieve benchrest accuracy and consistency without the extra cost of another seating die. Hornady® die sets already include an in-line seater; simply replace the standard seating adjustment stem with the MicroJust™ seating micrometer. Not for Taper Crimp/Seater Dies.

No. 044090



HORNADY® DIE WRENCH

Fits the flats of the Custom Grade™ dies spindle assembly, lock rings and die body.

No. 396490



BLANK AMMUNITION DIE SET

For loading blanks, this set produces a star crimp for all popular cartridges from 223 through 45-70. Compatible with 7/8" x 14 TPI presses.

No. 544591



TAPER CRIMP DIES

This die removes the flare from the case mouth and crimps the case mouth around the bullet while maintaining a sharp edge for proper headspace. Improves feeding of reloaded cases in semi-automatic handguns.

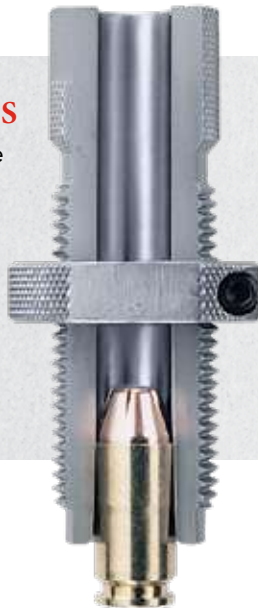

Taper Crimp Dies	Item No.
9mm Luger/9x21/38 Super Auto/380 Auto	044170
40 S&W - 10mm Auto	044171
45 ACP/WM 45 AR	044172
450 Bushmaster	044176
454 Casull	044588
460 S&W Mag	044722
480 Ruger/475 Linebaugh	044174
500 S&W Mag	044702



LOCK-N-LOAD® DELUXE DIE WRENCH

The Deluxe Die Wrench holds the shell plate and keeps it from rotating while you change plates and tighten the main press screw. It also adjusts the tightness of the spindle lock and the lock rings, and can tighten or loosen the die flats.

No. 396495



*Compatible with any brand
7/8"x14 dies.*

SURE-LOC™ LOCK RINGS

Upgrade your dies with our Sure-Loc™ Lock Rings. Allows precise adjustments of all standard 7/8"–14 dies and accessories.

Clamps around the whole die and won't damage the threads. Applies constant pressure across the threads to hold the ring in place.

WRENCH FLATS: Remove and replace dies without pliers damaging the lock ring.

No. 044000

6 Pack No. 044606





HORNADY SECURITY®



Hornady® is committed to promoting responsible gun ownership. Securely storing firearms when not in use is a key element of responsible gun ownership and the #1 way to help prevent firearm accidents, thefts and misuse.

As a firearms owner, you have many options for storage devices to fit your lifestyle and home. On the following pages, you'll find security products for handguns, rifles and shotguns. We hope you'll explore the storage options, including products, to see what we have available and determine what will work best for your situation.

Project ChildSafe has helped raise awareness about the safe and responsible ownership of firearms and the importance of securely storing firearms to help reduce accidents and access by unauthorized individuals.



WHY CHOOSE AN RFID-ENABLED SAFE FROM HORNADY SECURITY®?

RFID technology allows instant access with tags that can be programmed specifically for each safe. RFID tags include wristbands, key fobs, and decals. The decals can be adhered to plastic, glass, metal, wood — nearly any surface. Many people choose to adhere them to their mobile phone. By using RFID technology, there's no need to find a key, register a fingerprint, or remember a combination. Plus, the RFID-enabled device can be programmed to read up to five different tags.



RFID is the fastest, most reliable technology to gain access to a secure safe.

2020 SAFE & SECURE
FREE AMMO OFFER!



RAPiD® Safe Night Guard™

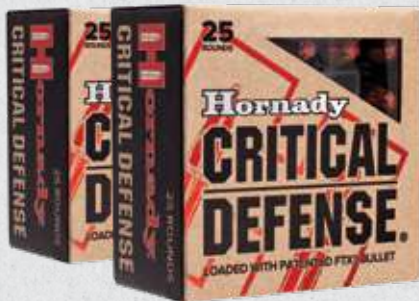

FREE AMMO
 WITH PURCHASE



RAPiD® Safe Vehicle Safe

RAPiD® Safes
 4800KP
 2700KP
 2600KP



RAPiD® Safe AR Wall Lock



RAPiD® Safe Shotgun Wall Lock

RAPiD® Safe AR Gunlocker



RAPiD® Safe Ready Vault™



PROTECT YOURSELF IN MORE WAYS THAN ONE!

For a limited time, participate in the Hornady® Safe & Secure promotion and you'll receive two free boxes of Critical Defense® ammunition when you purchase an RFID-enabled RAPiD® Safe.*

Patented RFID technology delivers the fastest access to your firearms. Simply place the RFID wristband, key fob or adhesive decal over the reader and the safe springs open to present your gun. Combined with the most reliable and effective personal defense ammunition on the market, you'll be safe and secure when you need it most.

Hornady Security® RAPID® Safes



More and more people are realizing the need and advantages of storing firearms in safe, yet accessible devices. By utilizing patented RFID technology, Hornady Security® RAPID® Safes offer the quickest, most dependable access to your firearm while providing unmatched security from unauthorized users. Simply place the included RFID wristband, key fob or decal over the safe's reader and it immediately opens for rapid retrieval of your firearm.



Mount horizontally or vertically.



All Hornady Security® RAPID® Safes offer the following features:

FAST AND DEPENDABLE TOUCH-FREE ENTRY

RFID activated by wristband, key fob or decal to immediately open the spring-assist lid. User can program up to five RFID tags for each safe.

CONVENIENT KEYPAD ACCESS

For secondary entry method, user can program a four to six digit security code. Each safe also comes with two circular barrel keys.

EXCEEDS SAFETY STANDARDS

RAPID® Safes are designed to exceed the highest safety standards from ASTM International, and many have been listed by the California DOJ as an approved firearm safety device.

HEAVY-DUTY, TAMPER-PROOF CONSTRUCTION

Exterior housing is made of thick steel and hardened interior locking lugs. Protect your safe from theft with the included 1500 lb rated security cable.

SAFE AND READY

AC and battery power ensures your guns are protected and ready to go 24/7.

EASY TO INSTALL

Pre-drilled mounting holes make it easy to secure your RAPID® Safe to a stationary object.

RAPID® Safe AR Gunlocker

The fully enclosed design of the AR Gunlocker provides convenient, tamper-proof security for up to two tactical length rifles.*

Exterior: 42" x 15.25" x 6.75"

Interior: 40.5" x 13.5" x 5.5"

Weight: 50 pounds

No. 98190

**SAFE & SECURE
FREE AMMUNITION
WITH PURCHASE
— SEE PAGE 124 —**



***IMPORTANT:** Do not store loaded firearms in any safe or lock box. Follow local, state and federal laws for firearm storage and transport. Check TSA regulations and airline policies before traveling with any portable safe. Check dimensions of your firearm against safe's internal dimensions. Firearm and firearm accessories not included.



Hornady Security® RAPiD® Safes

RAPiD® SAFE **NEW** READY VAULT™

FAST AND DEPENDABLE TOUCH-FREE ENTRY

Patented RFID technology unlocks safe faster than keypads and biometrics. Four included RFID tags including wristband, key fob, and two decals can be selectively programmed to open this safe and any other RAPiD® Safe you own.



ADAPTABLE STORAGE

Metal interior peg walls allow included gun racks to be mounted in numerous configurations. Additional accessories can be purchased to further organize the safe. Hornady Security LED lights, magnetic hooks, hygrometer and dehumidifiers are all compatible (sold separately).

PATENT PENDING GUN RACKS

Dual-purpose gun racks accommodate up to 8 long guns and 14 handguns by utilizing otherwise empty space between barrels. PVC coating protects firearms while deep standoffs provide room for large optics, and square peg hooks allow placement anywhere inside the safe.

HEAVY-DUTY, TAMPER-PROOF CONSTRUCTION

Heavy-duty steel housing and five hardened locking lugs provide confident protection of valuables. Pre-drilled mounting holes allow additional security.



PADDED FLOOR MAT

Neoprene floor mat prevents gun stocks from slipping, allowing long guns to be stored safely upright.

CONVENIENT KEYPAD ACCESS

Digital keypad and backup mechanical key offer additional entry methods.

SAFE AND READY

AC and battery power ensure firearms are protected and ready to go 24/7.

No. 98195

Exterior: 52.2" x 19.0" x 15.1"*
(*add 1.7" for handle)

Interior: 51.8" x 13.5" x 12.7"

**SAFE & SECURE
FREE AMMUNITION
WITH PURCHASE
— SEE PAGE 124 —**



***IMPORTANT:** Do not store loaded firearms in any safe or lock box. Follow local, state and federal laws for firearm storage and transport. Check TSA regulations and airline policies before traveling with any portable safe. Check dimensions of your firearm against safe's internal dimensions. Firearm and firearm accessories not included.

RAPiD® SAFE **NEW** NIGHT GUARD™

SAFE & SECURE
FREE AMMUNITION
WITH PURCHASE
— SEE PAGE 124 —

Hornady® introduces the perfect bedside companion. The RAPiD® Safe Night Guard™ keeps your handgun as close as your nightstand. RFID technology offers the quickest, most dependable access to your firearm while providing unmatched security from unauthorized users. Plus, the Night Guard™ offers the additional functionality of a clock and USB charging ports.

FAST AND DEPENDABLE TOUCH-FREE ENTRY

Patented RFID technology unlocks safe faster than keypads and biometrics. Four included RFID tags including wristband, key fob, and two decals can be selectively programmed to open this safe and any other RAPiD® Safe you own.

DISCREET DISPLAY PANEL AND SPRING-ASSIST DRAWER

Tempered glass front panel elegantly contains the RFID reader, clock display, and access code keypad. Spring-assist drawer quietly slides open to reveal a padded interior. Accommodates most full-sized handguns and/or valuables.

USB PORTS

USB ports provide convenient charging for cellphones or other devices.

HEAVY-DUTY, TAMPER-PROOF CONSTRUCTION

Designed to exceed the toughest industry standards for firearm storage with a heavy duty exterior housing and hardened interior locking lugs.

THREE ENTRY METHODS

RFID reader, user programmed access code, and mechanical key offer a variety of methods to unlock the RAPiD® Safe Night Guard™.

SAFE AND READY

AC and battery power ensure your guns and other valuables are protected and ready 24/7.

EASY TO INSTALL

Protect your safe from theft with the included 1,500-pound-rated security cable or use the pre-drilled mounting holes to secure your RAPiD® Safe Night Guard™ to a stationary object.

No. 98215

Exterior: 12" x 10.5" x 3"

Interior: 9.2" x 6.9" x 2.2"



Hidden in plain sight.



Touch-free RFID entry with wristband, key fob or decals.



USB-A and USB-C ports, key backup and security cable.



***IMPORTANT:** Do not store loaded firearms in any safe or lock box. Follow local, state and federal laws for firearm storage and transport. Check TSA regulations and airline policies before traveling with any portable safe. Check dimensions of your firearm against safe's internal dimensions. Firearm and firearm accessories not included.



Hornady Security® RAPiD® Safes

RAPiD® Vehicle Safe

The patent-pending mounting system of the RAPiD® Vehicle Safe features an inflatable bladder that conforms to either side of the center console, making modifications to the vehicle unnecessary. Power is supplied by the included 12-volt car adapter or four AAA batteries (not included).

- Fits duty size pistols and smaller.
- Exceeds ASTM International safety standards for child safety and pry resistance, lock strength, drop/pick/saw tests and hinge-attack resistance.
- 14-gauge steel exterior housing.
- Included security cable for attaching to seat frame.
- Mounting system has a neoprene cover to protect interior car finishes.

Contents: RAPiD® Vehicle Safe, 12V car adapter, RFID Wristband, two RFID Decals, RFID Key Fob, two Circular Barrel Keys, and Security Cable.



**SAFE & SECURE
FREE AMMUNITION
WITH PURCHASE
— SEE PAGE 124 —**

RAPiD® Vehicle Safe

No. 98210

Fits many 4-inch barrel pistols and 2-inch revolvers.*

Exterior: 12" x 6.4" x 2.2"
Interior: 7.5" x 5.6" x 1.7"



***IMPORTANT:** Do not store loaded firearms in any safe or lock box. Follow local, state and federal laws for firearm storage and transport. Check TSA regulations and airline policies before traveling with any portable safe. Check dimensions of your firearm against safe's internal dimensions. Firearm and firearm accessories not included.



SAFE & SECURE
FREE AMMUNITION
WITH PURCHASE
— SEE PAGE 124 —

RAPiD® Safe Shotgun Wall Lock

Designed specifically for shotguns, this safe can be mounted horizontally or vertically in closets, behind doors — anywhere you want quick access. Fits most shotguns.*

Exterior: 8.5" x 9.2" x 2.7"

No. 98180

RAPiD® Safe AR Wall Lock

SAFE & SECURE
FREE AMMUNITION
WITH PURCHASE
— SEE PAGE 124 —

Accommodating most AR-15 and AR-10 platforms, mount this safe in a horizontal or vertical position for quick access when you need it most.*

Exterior: 14.5" x 11" x 4.7"

No. 98185



INSTANT, TOUCH-FREE ACCESS WITH PATENTED RFID TECHNOLOGY



RFID WRISTBAND



RFID KEY FOB



RFID DECALS

ACCESSORIES AND REPLACEMENTS FOR YOUR RAPiD® SAFE

Every Hornady Security® RAPiD® Safe can be programmed to read up to five different RFID tags. Various tags and accessories are available:

- 1500 lb. Rated Cable
No. 98169
- Adjustable Wristband
No. 98166
- Silicone Bracelets
Small . . . No. 98160
Med . . . No. 98163
Large . . . No. 98164
XL. No. 98165
- Key Fob (2-pack)
No. 98161
- Adhesive Decal (2-pack)
No. 98168

RFID decals can be placed on your phone or any other convenient placement.



***IMPORTANT:** Do not store loaded firearms in any safe or lock box. Follow local, state and federal laws for firearm storage and transport. Check TSA regulations and airline policies before traveling with any portable safe. Check dimensions of your firearm against safe's internal dimensions. Firearm and firearm accessories not included.



Hornady Security® RApiD® Safes

RAPiD® Safe 2600KP, 2700KP & 4800KP

FAST AND DEPENDABLE TOUCH-FREE ENTRY

RFID activated by wristband, key fob or decal that instantly opens spring-assist lid. Up to five RFID tags can be programmed.

CONVENIENT KEYPAD ACCESS

For secondary entry method, user can program a four to six digit security code.

CERTIFIED CHILD-RESISTANT

Exceeds ASTM International safety standards for child safety and pry resistance, lock strength, drop/pick/saw tests and hinge attack resistance.

HEAVY-DUTY, TAMPER PROOF CONSTRUCTION

Exterior housing is made of thick 14 gauge steel with two internal hardened locking lugs.

SAFE AND READY

AC and battery power ensures your handgun is protected and ready to go 24/7.

MOBILE SECURITY

Included cable and pre-drilled mounting holes allow the safe to be secured in virtually any location. Meets TSA requirements for handgun safety in checked luggage.*

Contents: RApiD® Safe, Wall Power Supply, RFID Wristband, two RFID Decals, RFID Key Fob, two Circular Barrel Keys, and Security Cable.



All RApiD® Safes include a digitally programmed keypad as an alternate form of entry.

SAFE & SECURE
FREE AMMUNITION
WITH PURCHASE
— SEE PAGE 124 —

RAPiD® Safe 2600KP (Large)

No. 98177

Fits many 4-inch barrel pistols and 2-inch revolvers.*

Exterior: 10.7" x 8.7" x 2.9"
Interior: 7" x 7.7" x 2.2"

SAFE & SECURE
FREE AMMUNITION
WITH PURCHASE
— SEE PAGE 124 —

RAPiD® Safe 2700KP (X-Large)

No. 98172

Fits most 1911-size pistols and 4-inch revolvers.*

Exterior: 12.7" x 8.7" x 2.9"
Interior: 9" x 7.7" x 2.2"

SAFE & SECURE
FREE AMMUNITION
WITH PURCHASE
— SEE PAGE 124 —

RAPiD® Safe 4800KP (XX-Large)

No. 98141

Fits two 1911-sized pistols or one large revolver.*

Exterior: 10.5"x12"x2.9"
Interior: 7.2"x11"x2.2"



Hornady
SECURITY®

***IMPORTANT:** Do not store loaded firearms in any safe or lock box. Follow local, state and federal laws for firearm storage and transport. Check TSA regulations and airline policies before traveling with any portable safe. Check dimensions of your firearm against safe's internal dimensions. Firearm and firearm accessories not included.

Keypad Vaults



Keypad Vaults

Responsible gun owners know the importance of securing their firearms. Our new keypad vaults provide reliability, ease of use and affordable protection.

- Programmable 4 to 6 digit keypad code ensures convenient access to handguns and valuables.
- Constructed of thick 16-gauge steel.
- Interior light automatically illuminates when opening.
- Premium foam interior cradles and protects valuable contents.
- California Department of Justice approved firearm storage device.
- Backup barrel key lock with two keys.
- Requires four AAA batteries (not included).
- Pre-drilled for easy mounting.
- Selectable audible and visible low-battery indicators.



Keypad Vault



2-Gun Keypad Vault with removeable shelf

Keypad Vault

Item No. 95432

Fits 1911 size pistols and 4-inch revolvers.*

Exterior: 12" x 8.3" x 2.6"
Interior: 11.5" x 6" x 2.4"

2-Gun Keypad Vault

Item No. 95430

In addition to the features mentioned above, the 2-Gun Vault offers a spring-loaded door for quick access and a removable shelf that provides twice the interior space.

Fits 1911 size pistols and 4-inch revolvers.*

Exterior: 12.7" x 9" x 8.8"
Interior: 11.4" x 8.6" x 6.3"



Programmable keypad



***IMPORTANT:** Do not store loaded firearms in any safe or lock box. Follow local, state and federal laws for firearm storage and transport. Check TSA regulations and airline policies before traveling with any portable safe. Check dimensions of your firearm against safe's internal dimensions. Firearm and firearm accessories not included.



Lock Boxes

Alpha Elite™ Lock Box

BEST-IN-CLASS

Patent pending dual crossbar latch mechanism delivers best-in-class security.*

HEAVY-DUTY CONSTRUCTION

Tough 16-gauge steel housing with pry-resistant security band and barrel key lock provide tamper-proof construction.

CERTIFIED CHILD-RESISTANT

Exceeds ASTM International and CA DOJ safety standards for child safety and pry resistance, lock strength, drop/pick/saw tests, and hinge attack resistance.

Contents: Alpha Elite™ Lock Box, two Circular Barrel Keys, and Security Cable.



U.S. Design Patent No. D786,047



Alpha Elite™ Lock Box

Item No. 98153

Fits 1911 size pistols and 4-inch revolvers.*

Exterior: 10.25" x 8" x 2.75"
Interior: 9.75" x 7.5" x 2.25"

BEST IN CLASS

Lock Boxes Large & X-Large

- Reliable steel barrel lock opens smoothly and comes with two keys.
- 4-foot steel security cable withstands up to 1,500 pounds of force.
- Patented space-saving cable receiver allows maximum storage inside box.
- Durable 16-gauge steel housing protects against pry attempts.
- Premium foam interior cradles and protects valuable contents.

Contents: Key Lock Safe, two Circular Barrel Keys, and Security Cable.



Lock Box (Large)

Item No. 95200

Fits most 4-inch barrel pistols and some 4-inch revolvers.*

Exterior: 9.5" x 6.5" x 1.75"
Interior: 9.25" x 6.25" x 1.5"

Lock Box (X-Large)

Item No. 95210

Fits 1911 size pistols and 4-inch revolvers.*

Exterior: 10" x 7" x 2"
Interior: 9.75" x 6.75" x 1.75"



***IMPORTANT:** Do not store loaded firearms in any safe or lock box. Follow local, state and federal laws for firearm storage and transport. Check TSA regulations and airline policies before traveling with any portable safe. Check dimensions of your firearm against safe's internal dimensions. Firearm and firearm accessories not included.

Safe Accessories



PISTOL RACKS

Maximize storage in your gun safe or cabinet. PVC coating won't scratch or damage your gun's finish.

4-Gun Pistol Rack
No. 95820



8-Gun Pistol Rack
No. 95840



UNIVERSAL HANDGUN HANGERS

PVC-coated hardened steel hangers accommodate heavy handguns (22 caliber and larger). Slide onto 1/2-inch to 1-inch thick shelf.

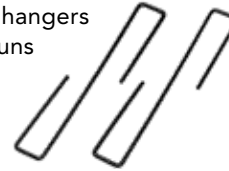

No. 95870



MAGNETIC SAFE HOOKS

Position these hooks on the corner of any gun safe or metal surface to securely store gear such as gun cases, binoculars and range bags. Hooks are rated for 15 pounds and are secured with heavy-duty magnets.

2-Pack No. 95911

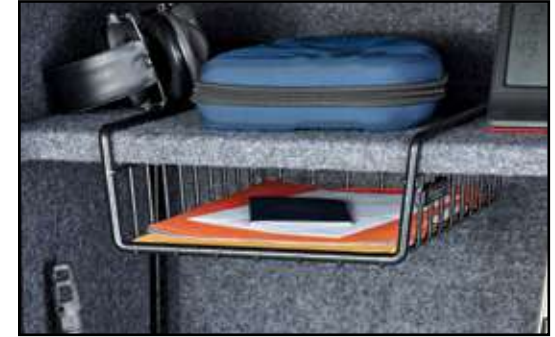

MAGNUM HANGING BASKET

This basket slides neatly onto a 1/2-inch to 1-inch shelf in your safe, closet or cabinet, creating additional space for legal-sized documents and supports 40 pounds.

No. 96012

CORDLESS LED SAFE LIGHT

Twenty white LEDs provide 70 lumens of light for gun safes, closets, cabinets, drawers and corridors. With on/off/auto modes, light bar can be set to illuminate when motion is detected and shut off after 20 seconds. Includes two magnetic bases for attaching to metal walls or doors.

No. 96001





Safe Accessories



RECHARGEABLE GUN SAFE DEHUMIDIFIER

Absorb humidity and prevent rust or mildew in gun safes and other enclosed areas. Moisture-control crystals change from blue to pink when unit needs recharging. Recharge by plugging into 110V electrical outlet.

No. 95900



Install quick-connect bracket on interior door or wall of safe or vault room.



CANISTER DEHUMIDIFIER

Protect your valuables against rust and corrosion. When the desiccant crystals change color, recharge unit by placing it in a warm oven. Unlimited recharges ensure a lifetime of use.

No. 95902

GUN SAFE DEHUMIDIFIER ROD

Just plug it in for a permanent, maintenance-free solution for humidity control in gun safes and small enclosures. Dehumidifier Rod minimizes condensation, mildew and dampness. Coverage is approximately 100 cubic feet. Quick-change plugs allows easy installation.

12-inch No. 95903



DIGITAL HYGROMETER

Large touchscreen displays high/low for temperature and humidity in Fahrenheit or Celsius. Install quick-connect bracket on interior door or wall of safe or vault room, or use fold-out stand. Requires two AAA batteries (not included).

No. 95909



Install quick-connect bracket on interior door or wall of safe or vault room, or use fold-out stand.

Hornady® Hats



STEVE HORNADY **NEW** “SIGNATURE” MESH BOONIE

Embroidered logos, one size fits most. Mesh side panels keep the bean cool. Imported.

No. 9942

HORNADY® BEANIES

Embroidered logos, one size fits most. Imported.



Fleece

Knit

OD Green Fleece No. 99399

Camo Fleece No. 99294

Blaze Orange Knit No. 99393

HORNADY® NECK GAITER **NEW**

Imported. 100% polyester

No. 9926



NEW

Gray Mountain
No. 99282



NEW

Brown & Tan Camouflage Mesh
No. 99291



NEW

Gray Kryptek® Camouflage Mesh
No. 99292



NEW

Gray & Green Mesh
No. 99385



NEW

Blue & White Mesh
No. 99345



Blaze Orange
No. 99262



Black Mesh
No. 99281



Gray & Orange Mesh
No. 99295



Gray with Leather Logo
No. 99261



OD & Tan Mesh
No. 99284



Sage Green
No. 99283



American Flag
No. 99223



Hornady® Apparel



OUTFITTER HOODIE **NEW**

Poly-cotton blend. Imported.

No. 9972 (M-XL)
(XXL)



SOLAR HOODIE **NEW**

UPX 50+ sun protection. 100% polyester. Imported.

No. 99692 (S-XXL)
(XXXL)



OUTFITTER T-SHIRT **NEW**

Poly-cotton blend. Imported.

No. 99693 (M-XL)
(XXL)
(XXXL)



SAGE GREEN T-SHIRT

Poly-cotton blend with subdued logo, perfect for hunting. Imported.

No. 9974 (M-XL)
(XXL)



HORNADY® POLO SHIRTS **NEW**

Poly-cotton blend. Embroidered Hornady® logo. Imported.

Red No. 99731 (M-XXL) (XXXL)
Black No. 99771 (M-XXL) (XXXL)

Shooter Accessories



RELOADING BENCH STOOL

Providing a comfortable and stylish seat in your reloading room, garage or bar. This custom designed stool features a Hornady® logo on the seat and is made of durable marine grade vinyl, thick foam padding and chrome double rung reinforced legs.

Seat dimensions:
14 x 14 x 5 inches.

Overall dimensions:
20 x 20 x 31 inches.

No. 99103



TEAM HORNADY® 30 OZ. INSULATED TUMBLER

Enjoy your favorite beverage with this insulated tumbler crafted from stainless steel with Team Hornady® logo and clear plastic lid. Keeps beverages cold for approximately 8 hours or hot for 3 hours.

No. 99134



HORNADY® 17" NEON CLOCK

Light up any room with the Hornady® 17" Retro Neon Clock! Featuring a chrome frame, and red and white neon. The light runs via power cord and the clock requires AA batteries (not included).

No. 99125

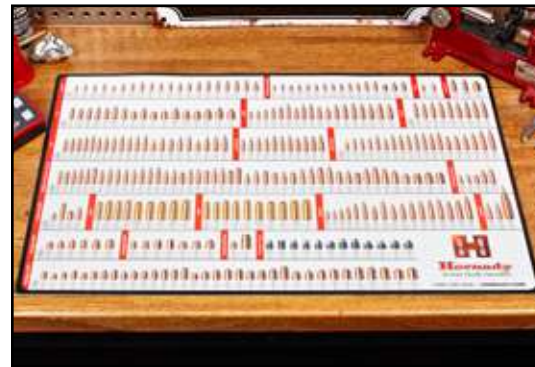

RELOADING COUNTER MAT

The ultimate reference tool for your reloading bench. This non-skid bullet mat features the Hornady® bullet line with corresponding caliber, diameter, weight, ballistic coefficient, sectional density, and item number. (Measures 26" x 17")

No. 99102



HORNADY® CARTRIDGE INTRODUCTIONS BOARD

Shadow-box style display with wood frame measures 16" x 10." Display features 21 cartridges that Hornady® has introduced as SAAMI cartridges since 1988. Made in the USA.

No. 9948



HORNADY® COASTER SET

Set of four 4¼" square absorbent stone coasters with cork backing imprinted with weathered Hornady® logo.

No. 99104



Shooter Accessories



BINOCULAR CASE

Protect your binoculars, range finder, GPS or spare ammo with this quiet quick-access case. Built from tough, nylon Cordura® with a micro fiber liner and padded sides, the case features heavy-duty zippers and X-panel harness that distributes weight over four elastic straps. Measures 7.5 x 10.2 x 3.4 inches.



No. 99128



BINOCULAR HARNESS

Designed for comfort and flexibility, this harness distributes the weight of your binoculars over the four elastic straps and form-fitting X panel, alleviating neck pain. Easy to put on and take off, the X panel on the back features an imprinted Hornady® logo.



No. 99121



HORNADY® HITCH COVER

Show off your passion for the Hornady® brand with this plastic hitch cover. Fits most 2-inch hitch receivers with snap clips to hold it in place.

No. 99132

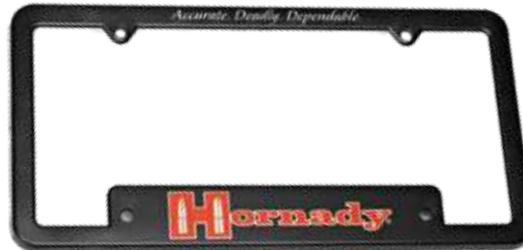

HORNADY® LICENSE PLATE FRAME

This plastic license plate frame features the classic Hornady® company logo on the bottom and our "Accurate. Deadly. Dependable.®" slogan on the top. Made in the USA.

No. 99119



HORNADY® SHOOTERS CHEEK PAD

Made of tough, nylon Cordura® with elastic loops and a zippered accessory pouch, this stock pad is the perfect accessory for your rifle. This versatile pouch can hold five cartridges on the exterior while providing a padded cheek weld. Available in left or right-handed models. Imported.

Black RH No. 99108

Black LH No. 99113

Tan RH No. 99110

HORNADY® BELT BUCKLE

Cast in antique pewter with raised and recessed relief, this rectangular buckle with rounded corners features the Hornady® logo and slogan, "Accurate. Deadly. Dependable.®" Designed to fit belts that are 1½" wide, the buckle measures 4"x 3" and can be kept clean by polishing with a damp cloth. Packaged in a black gift box. Made in U.S.A.



No. 99129



HORNADY® AMMO POUCH

In working with our friends at TUFF® products, we offer a simple ammunition pouch for those who want to keep several cartridges on hand and want the flexibility to have them readily available. With Velcro® closure, the pouch includes 10 elastic loops and an interior pocket. Imported.

No. 99116



HORNADY® SCOPE COVER

Safeguard your scopes from dings, scratches, dirt and moisture. Constructed of high quality neoprene that wicks moisture away from the scope and helps protect it from rust and corrosion. Will not work on scopes with tall target-style turrets.

No. 99133



HORNADY® SOFT RIFLE CASE

This 48-inch padded rifle case features two exterior zippered pockets and is made of tough, nylon Cordura® for strength and durability. Imported.

No. 99120

HORNADY® SOFT PISTOL CASE

Designed in collaboration with our friends at TUFF® products, this case features a rubber Hornady® embossed patch and can accommodate one semi-automatic handgun and five magazines, or one 5.5 inch barreled full size revolver and two speed loaders. Dimensions: 8½" x 13½" and 1½" thick (when empty). Heavy-duty YKK zipper and tough, nylon Cordura® are used for strength and durability. Imported.

No. 99117



TEAM HORNADY® RANGE BAG

This durable nylon range bag has large compartments for the range shooter or uniformed officer. With embroidered Team Hornady® logos, this range bag can carry a variety of accessories. Imported.

No. 9919



UNIVERSAL SLING

Developed by the Hunter Company of Colorado, this durable leather and nylon sling is built to endure the toughest hunts.

No. 99107

Shooter Accessories

JOYCE HORNADY ON RELOADING & BULLET ACCURACY

Widely acclaimed by shooters, this informative video is for reloading pros and beginners alike. Bonus feature includes an introduction to metallic reloading by Steve Hornady.

No. 9979



LOCK-N-LOAD® BOLT BALL

This accessory enables better bolt handling for faster reloads and is easy to grip when shooting with gloves. No altering of the original bolt required. It adapts to most conventional round bolt handles.

No. 99123



HORNADY® RAPID RACK™

This empty chamber indicator operates as a load-assist device for those who prefer to keep their long gun ready with a fully charged magazine and a visibly empty chamber.

Simply insert the cartridge-shaped portion of the Rapid Rack™ into the chamber leaving the colored lever protruding from the gun's ejection port. Close the bolt and insert a loaded magazine. The colored lever visually displays an empty chamber. Grab the lever and pull straight back, allowing the Rapid Rack™ to fall to the ground so the fully charged bolt springs forward to feed a round into the chamber.

Rapid Rack™ AR-15 (223/5.56)
No. 98201

HORNADY® BUCK® 110 KNIFE

Our 110 folding hunter knife features a Macassar Ebony Dymondwood handle and nickel-plated bolsters. The blade is made of 420 HC stainless steel for years of reliable use. Made in the USA.

No. 99126

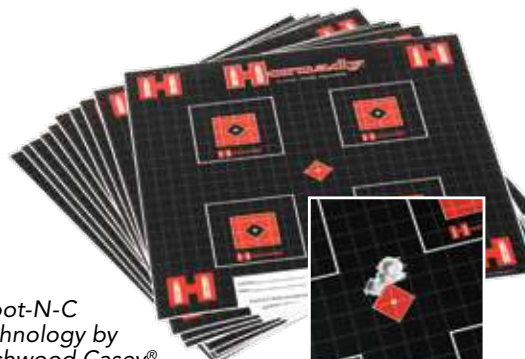

Shoot-N-C
Technology by
Birchwood Casey®

LOCK-N-LOAD® TARGETS

Hornady Lock-N-Load® Targets feature a half-inch grid pattern and multiple aiming points. Vivid white bullet holes provide long-range visibility without binoculars or spotting scopes. Immediate feedback makes target practice fun and productive.

10 Pack No. 9963
100 Pack No. 9963B

HORNADY® BUCK® KNIFE

The Buck Vantage™ series knife features a Hornady® logo on the strong side of the blade. High impact polymer handle and pocket clip. Made in the USA.

No. 99181



KESTREL® 5700 **NEW** BALLISTICS WEATHER METER WITH HORNADY® 4DOF®

Combining complete onsite environmental measurements with the precise trajectory solutions of the integrated Hornady 4DOF® ballistics solver, this rugged all-in-one handheld unit delivers the convenience you want and the accuracy you need for long-range success under any conditions.



Stickers & Shooter Accessories



1



2



3



4

5



6



7



8



9

HORNADY® STICKERS

- ① **Team Hornady® Antlers . . .No. 98006**
White and red. Measures 5.5" x 3.875"
- ② **Red Hornady® LogoNo. 98004**
White and red. Measures 3.5" x 3.5"
- ③ **Superformance®No. 98008**
Black and red. Measures 3" x 5.125"
- ④ **Fueled by Hornady®No. 98002**
Black and red. Measures 5.625" x 0.6875"
- ⑤ **Team Hornady®No. 98003**
Red and white. Measures 2.375" x 6"
- ⑥ **Law EnforcementNo. 98000**
Black and red. Measures 3.125" x 4.625"
- ⑦ **Red H Transfer Sticker . . .No. 98013**
Red and white. Measures 4" x 4.5"
- ⑧ **Get Loaded®No. 98014**
Red and white. Measures 4.5" x 5"
- ⑨ **Stop SignNo. 98015**
Red and white. Measures 3.5" x 3.5"

DECORATIVE HORNADY® TIN SIGNS

These tin signs provide just the right accent for your trophy room, garage, or reloading area. Each have rounded corners and four pre-drilled holes for easy hanging.



Measures 12" x 18"
No. 99112



Measures 12" x 18"
No. 99130

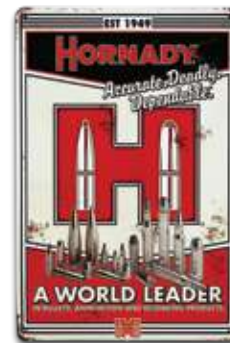

Measures 12" x 18"
No. 99101



Measures 18" x 12"
No. 99118



Measures 10" x 10"
No. 99136

HORNADY® BANNERS

Indoor/outdoor banners with grommets.



Measures 48" x 36"
No. BANRFR



Measures 40" x 48"
No. BANRLG



Dies & Reloading Essentials

SERIES I: The most popular bottleneck rifle cartridges.
Two die set: size die and bullet seater die.

SERIES II: The most popular handgun cartridges.
Three die set: size die, expander die, seating die.

SERIES III: A second tier of bottleneck rifle cartridges.
Two die set: size die and bullet seater die. For slightly less popular cartridges.

SERIES IV: Another tier of bottleneck rifle cartridges, obscure, almost semi-custom. Two die set: size die and seater die. Very low volume. Includes the Nitro Express cartridges.

SERIES V: The magnum handgun cartridges, and straight-wall rifle cartridges that require a special crimp (i.e. 450 Bushmaster is the only one). Four die set: size die, expander die, bullet seater die, and a special taper crimp die.

Match Grade™ Dies

MATCH CARTRIDGE	Bullet Diameter (inches)	Die Set	Die Series	Full-Length Size Die	Seating Die	Expander Die	Taper Crimp Die Only	Neck Size Die	Shell Holder # / Item No.	Shell Plate # / Item No.	Case Feeder Plate Size / Item No.	Bullet Feeder Die	Trimmer Pilot # / Item No.	Primer Punch	Bullet Puller Collet # / Item No.	Modified Case
223 REM	0.224	544207	—	544229	044102	—	—	544227	#16 / 390556	#16 / 392616	Sm Rfl / 095314	095340	#1 / 390943	Small	#2 / 392155	A223
6MMx47 LAPUA	0.243	544610	—	—	—	—	—	—	#1 / 390541	#1 / 392601	Sm Rfl / 095314	—	#3 / 390945	Small	#3 / 392156	—
6MM PPC	0.243	544241	—	544255	—	—	—	544253	#6 / 390546	#6 / 392606	Sm Rfl / 095314	—	#3 / 390945	Small	#3 / 392156	C6PPC
6MM BR REM	0.243	544249	—	544251	—	—	—	544259	#1 / 390541	#1 / 392601	Sm Rfl / 095314	—	#3 / 390945	Small	#3 / 392156	A6MMB
6MM CREEDMOOR	0.243	544247	—	046204	—	—	—	—	#1 / 390541	#1 / 392601	Lg Rfl / 095316	—	#3 / 390945	Large	#3 / 392156	A6MMC
6.5X47 LAPUA	0.264	544650	—	—	—	—	—	—	#1 / 390541	#1 / 392601	— / —	—	#5 / 390947	Small	#4 / 392157	—
6.5X55	0.264	544281	—	046216	—	—	—	—	#19 / 390559	#19 / 392619	Lg Rfl / 095316	—	#5 / 390947	Large	#4 / 392157	B65X55
260 REM	0.264	544277	—	046214	—	—	—	—	#1 / 390541	#1 / 392601	Lg Rfl / 095316	—	#5 / 390947	Large	#4 / 392157	—
6.5 CREEDMOOR	0.264	544655	—	—	—	—	—	—	#1 / 390541	#1 / 392601	Lg Rfl / 095316	—	#5 / 390947	Large	#4 / 392157	—
6.5-284 NORMA	0.264	544295	—	046218	—	—	—	—	#1 / 390541	#1 / 392601	Lg Rfl / 095316	—	#5 / 390947	Large	#4 / 392157	B65
6.5 PRC	0.264	544283	—	046288	—	—	—	—	#5 / 390545	#5 / 392605	Lg Rfl / 095316	—	#5 / 390947	Large	#4 / 392157	B65P
284 WIN	0.284	544303	—	046232	—	—	—	—	#1 / 390541	#1 / 392601	Lg Rfl / 095316	—	#7 / 390949	Large	#6 / 392159	—
280 ACKLEY IMP	0.284	544323	—	046228	—	—	—	—	#1 / 390541	#1 / 392601	Lg Rfl / 095316	—	#7 / 390949	Large	#6 / 392159	A280AI
7MM REM SA ULTRA MAG	0.284	544311	—	046224	—	—	—	—	#5 / 390545	#5 / 392605	Lg Rfl / 095316	—	#7 / 390949	Large	#6 / 392159	B7MMR
7MM REM MAG	0.284	544325	—	046234	—	—	—	—	#5 / 390545	#5 / 392605	Lg Rfl / 095316	—	#7 / 390949	Large	#6 / 392159	A7MMR
7MM WSM	0.284	544329	—	046226	—	—	—	—	#35 / 390575	#35 / 392635	Lg Rfl / 095316	—	#7 / 390949	Large	#6 / 392159	B7WS
308 WIN	0.308	544355	—	544359	—	—	—	544357	#1 / 390541	#1 / 392601	Lg Rfl / 095316	095345	#9 / 390951	Large	#7 / 392160	A308
30-06 SPRG	0.308	544339	—	046236	—	—	—	—	#1 / 390541	#1 / 392601	Lg Rfl / 095316	095345	#9 / 390951	Large	#7 / 392160	A3006
300 WSM	0.308	544353	—	046242	—	—	—	046057	#35 / 390575	#35 / 392635	Lg Rfl / 095316	095345	#9 / 390951	Large	#7 / 392160	B300W
300 WIN MAG	0.308	544351	—	046240	—	—	—	—	#5 / 390545	#5 / 392605	Lg Rfl / 095316	095345	#9 / 390951	Large	#7 / 392160	A300M
300 PRC	0.308	544349	—	046338	—	—	—	—	#5 / 390545	#5 / 392605	Lg Rfl / 095316	095345	#9 / 390951	Large	#7 / 392160	B300P
300 NORMA MAG	0.308	544371	—	046248	—	—	—	—	#43 / 390583	— / —	Lg Rfl / 095316	095345	#9 / 390951	Large	#7 / 392160	—
300 REM ULTRA MAG	0.308	544367	—	046246	—	—	—	—	#5 / 390545	#5 / 392605	Lg Rfl / 095316	095345	#9 / 390951	Large	#7 / 392160	B300
338 NORMA MAG	0.338	544397	—	046250	—	—	—	046058	#43 / 390583	— / —	Lg Rfl / 095316	—	#13 / 390955	Large	#9 / 392162	—
338 LAPUA MAG	0.338	544399	—	046252	—	—	—	—	#43 / 390583	— / —	Lg Rfl / 095316	—	#13 / 390955	Large	#9 / 392162	C338L

RIFLE CARTRIDGE	Bullet Diameter (inches)	Die Set	Die Series	Full-Length Size Die	Seating Die	Expander Die	Taper Crimp Die Only	Neck Size Die	Shell Holder # / Item No.	Shell Plate # / Item No.	Case Feeder Plate Size / Item No.	Bullet Feeder Die	Trimmer Pilot # / Item No.	Primer Punch	Bullet Puller Collet # / Item No.	Modified Case
BLANK CART 22-45 CAL	—	544591	IV	—	—	—	—	—	—/—	—/—	—/—	—	—/—	—	—/—	—
17 HORNET	0.172	546118	I	046202	044101	—	—	—	#3 / 390543	#3 / 392603	Sm Rfl / 095314	—	^ / 390942	Small	#1 / 392154	A17H
17 REM FIREBALL	0.172	546117	III	046200	044101	—	—	—	#16 / 390556	#16 / 392616	Sm Rfl / 095314	—	^ / 390942	Small	#1 / 392154	—
17 REM	0.172	546200	III	046201	044101	—	—	—	#16 / 390556	#16 / 392616	Sm Rfl / 095314	—	^ / 390942	Small	#1 / 392154	A17
17-222	0.172	546202	IV	—	—	—	—	—	#16 / 390556	#16 / 392616	Sm Rfl / 095314	—	^ / 390942	Small	#1 / 392154	—
17-223	0.172	546204	IV	—	—	—	—	—	#16 / 390556	#16 / 392616	Sm Rfl / 095314	—	^ / 390942	Small	#1 / 392154	—
20 VT	0.204	546205	III	046206	044139	—	—	046038	#16 / 390556	#16 / 392616	Sm Rfl / 095314	—	#22 / 390940	Small	#14 / 392167	—
20 TACTICAL	0.204	546209	III	046208	044139	—	—	046038	#16 / 390556	#16 / 392616	Sm Rfl / 095314	—	#22 / 390940	Small	#14 / 392167	—
204 RUGER	0.204	546201	I	046590	044139	—	—	046038	#16 / 390556	#16 / 392616	Sm Rfl / 095314	—	#22 / 390940	Small	#14 / 392167	B204
5.45X39	0.221	546199	III	046561	044220	—	—	—	#56 / 390611	—/—	Sm Rfl / 095314	—	#1 / 390943	Small	#2 / 392155	—
22 HORNET	0.224	546212	I	046213	044206	—	—	046066	#3 / 390543	#3 / 392603	Sm Rfl / 095314	—	#1 / 390943	Small	#2 / 392155	—
22 K-HORNET	0.224	546214	IV	—	—	—	—	046066	#3 / 390543	#3 / 392603	Sm Rfl / 095314	—	#1 / 390943	Small	#2 / 392155	—
5.7X28 FN	0.224	546203	III	046212	044136	—	—	—	#37 / 390577	—/—	Sm Rfl / 095314	—	#1 / 390943	Small	#2 / 392155	—
218 BEE	0.224	546206	IV	—	—	—	—	046066	#7 / 390547	#7 / 392607	Sm Rfl / 095314	—	#1 / 390943	Small	#2 / 392155	A218
221 REM FIREBALL	0.224	546210	III	046211	044102	—	—	046040	#16 / 390556	#16 / 392616	Sm Rfl / 095314	095340	#1 / 390943	Small	#2 / 392155	A221
222 REM	0.224	546224	I	046225	044102	—	—	046040	#16 / 390556	#16 / 392616	Sm Rfl / 095314	095340	#1 / 390943	Small	#2 / 392155	A222
223 REM	0.224	546228	I	046229	044102	—	—	046040	#16 / 390556	#16 / 392616	Sm Rfl / 095314	095340	#1 / 390943	Small	#2 / 392155	A223
22 PPC	0.224	546216	IV	—	—	—	—	046053	#6 / 390546	#6 / 392606	Sm Rfl / 095314	095340	#1 / 390943	Small	#2 / 392155	—
5.6X50 MAG	0.224	546234	IV	—	—	—	—	046040	#16 / 390556	#16 / 392616	Sm Rfl / 095314	095340	#1 / 390943	Small	#2 / 392155	—
219 ZIPPER	0.224	546208	IV	—	—	—	—	046040	#2 / 390542	#2 / 392602	Lg Rfl / 095316	095340	#1 / 390943	Large	#2 / 392155	—
225 WIN	0.224	546232	III	046233	044127	—	—	046040	#4 / 390544	#4 / 392604	Lg Rfl / 095316	095340	#1 / 390943	Large	#2 / 392155	—
22 NOSLER	0.224	546207	III	046286	044127	—	—	046040	#16 / 390556	#16 / 392616	Sm Rfl / 095314	095340	#1 / 390943	Small	#2 / 392155	—
224 VALKYRIE	0.224	546211	I	046559	044102	—	—	046040	#12 / 390552	#12 / 392612	Lg Rfl / 095316	095340	#1 / 390943	Small	#2 / 392155	A224
224 WBY MAG	0.224	546230	IV	—	—	—	—	046040	#17 / 390557	—/—	Lg Rfl / 095316	095340	#1 / 390943	Large	#2 / 392155	—
22-250 REM	0.224	546220	I	046221	044102	—	—	046040	#1 / 390541	#1 / 392601	Lg Rfl / 095316	095340	#1 / 390943	Large	#2 / 392155	A22250
22-250 ACKLEY IMP	0.224	546219	IV	—	—	—	—	046040	#1 / 390541	#1 / 392601	Lg Rfl / 095316	095340	#1 / 390943	Large	#2 / 392155	—
22 CREEDMOOR	0.224	546217	III	046560	044127	—	—	046040	#1 / 390541	#1 / 392601	Lg Rfl / 095316	095340	#1 / 390943	Large	#2 / 392155	B22C
220 SWIFT	0.224	546222	I	046223	044127	—	—	046054	#4 / 390544	#4 / 392604	Lg Rfl / 095316	095340	#1 / 390943	Large	#2 / 392155	A220
5.6X57	0.224	546236	IV	—	—	—	—	—	#1 / 390541	#1 / 392601	Lg Rfl / 095316	—	#1 / 390943	Large	#2 / 392155	—
223 WSSM	0.224	546223	III	046558	044707	—	—	—	#35 / 390575	#35 / 392635	Lg Rfl / 095316	—	#1 / 390943	Large	#2 / 392155	B223
22-6MM	0.224	546249	III	046238	044127	—	—	046054	#1 / 390541	#1 / 392601	Lg Rfl / 095316	095340	#1 / 390943	Large	#2 / 392155	—
22 SAVAGE HP	0.227	546240	IV	—	—	—	—	—	#2 / 390542	#2 / 392602	Lg Rfl / 095316	—	#2 / 390944	Large	#2 / 392155	—
5.6X52R	0.227	546238	IV	—	—	—	—	—	#2 / 390542	#2 / 392602	Lg Rfl / 095316	—	#2 / 390944	Large	#2 / 392155	—
6MM-223	0.243	546248	IV	—	—	—	—	046047	#16 / 390556	#16 / 392616	Sm Rfl / 095314	—	#3 / 390945	Small	#3 / 392156	—
6MM TCU	0.243	546256	IV	—	—	—	—	046047	#16 / 390556	#16 / 392616	Sm Rfl / 095314	—	#3 / 390945	Small	#3 / 392156	—
6MMX47 REM	0.243	546258	IV	—	—	—	—	046047	#16 / 390556	#16 / 392616	Sm Rfl / 095314	—	#3 / 390945	Small	#3 / 392156	—
6MM PPC	0.243	546254	IV	—	—	—	—	046052	#6 / 390546	#6 / 392606	Sm Rfl / 095314	—	#3 / 390945	Small	#3 / 392156	B6PPC
6MM BR REM	0.243	546432	IV	—	—	—	—	046047	#1 / 390541	#1 / 392601	Sm Rfl / 095314	—	#3 / 390945	Small	#3 / 392156	A6MMB
6MM HAGAR	0.243	546303	IV	—	—	—	—	—	#12 / 390552	#12 / 392612	Sm Rfl / 095314	—	#3 / 390945	Large	#3 / 392156	—
243 WIN	0.243	546244	I	046245	044103	—	—	046041	#1 / 390541	#1 / 392601	Lg Rfl / 095316	—	#3 / 390945	Large	#3 / 392156	A243
6MM REM	0.243	546246	III	046247	044103	—	—	046041	#1 / 390541	#1 / 392601	Lg Rfl / 095316	—	#3 / 390945	Large	#3 / 392156	A6MM
6MM CREEDMOOR	0.243	546295	I	046254	044183	—	—	046041	#1 / 390541	#1 / 392601	Lg Rfl / 095316	—	#3 / 390945	Large	#3 / 392156	A6MMC
6MM-284	0.243	546250	IV	—	—	—	—	046041	#1 / 390541	#1 / 392601	Lg Rfl / 095316	—	#3 / 390945	Large	#3 / 392156	—

^17 cal. trimmer pilots include a cutter for the Hornady® Cam Lock™ Trimmer.

*Discontinued SKUs with limited inventory.

RIFLE CARTRIDGE	Bullet Diameter (inches)	Die Set	Die Series	Full-Length Size Die	Seating Die	Expander Die	Taper Crimp Die Only	Neck Size Die	Shell Holder # / Item No.	Shell Plate # / Item No.	Case Feeder Plate Size / Item No.	Bullet Feeder Die	Trimmer Pilot # / Item No.	Primer Punch	Bullet Puller Collet # / Item No.	Modified Case
240 WBY MAG	0.243	546242	IV	—	—	—	—	046041	#1 / 390541	#1 / 392601	Lg Rfl / 095316	—	#3 / 390945	Large	#3 / 392156	B240
243 WSSM	0.243	546225	III	046557	044708	—	—	—	#35 / 390575	#35 / 392635	Lg Rfl / 095316	—	#3 / 390945	Large	#3 / 392156	B243
25-20 WIN	0.257	546264	IV	—	—	—	—	—	#7 / 390547	#7 / 392607	Sm Rfl / 095314	—	#4 / 390946	Small	#4 / 392157	—
256 WIN	0.257	546272	IV	—	—	—	—	—	#6 / 390546	#6 / 392606	Sm Rfl / 095314	—	#4 / 390946	Large	#4 / 392157	—
25-35 WIN	0.257	546266	IV	—	—	—	—	—	#2 / 390542	#2 / 392602	Lg Rfl / 095316	—	#4 / 390946	Large	#4 / 392157	—
25 REM	0.257	546260	III	046276	044104	—	—	—	#12 / 390552	#12 / 392612	Lg Rfl / 095316	—	#4 / 390946	Large	#4 / 392157	—
250 SAVAGE	0.257	546270	IV	—	—	—	—	046042	#1 / 390541	#1 / 392601	Lg Rfl / 095316	—	#4 / 390946	Large	#4 / 392157	A250
257 ROBERTS	0.257	546274	III	046275	044104	—	—	046042	#1 / 390541	#1 / 392601	Lg Rfl / 095316	—	#4 / 390946	Large	#4 / 392157	A257
25 WSSM	0.257	546263	IV	—	—	—	—	—	#35 / 390575	#35 / 392635	Lg Rfl / 095316	—	#4 / 390946	Large	#4 / 392157	B25
25-06 REM	0.257	546262	I	046263	044104	—	—	046042	#1 / 390541	#1 / 392601	Lg Rfl / 095316	—	#4 / 390946	Large	#4 / 392157	A2506
257 WBY MAG	0.257	546276	III	046277	044104	—	—	046042	#5 / 390545	#5 / 392605	Lg Rfl / 095316	—	#4 / 390946	Large	#4 / 392157	B257
6.5 TCU	0.264	546296	IV	—	—	—	—	046048	#16 / 390556	#16 / 392616	Sm Rfl / 095314	—	#5 / 390947	Small	#4 / 392157	—
6.5 JAP	0.264	546290	III	046291	044106	—	—	046043	#34 / 390574	— / —	Lg Rfl / 095316	—	#5 / 390947	Large	#4 / 392157	—
6.5 GRENDL	0.264	546291	I	046598	044164	—	—	—	#6 / 390546	#6 / 392606	Sm Rfl / 095314	—	#5 / 390947	Large	#4 / 392157	A65G
6.5X54 M-SCH	0.264	546292	IV	—	—	—	—	046043	#20 / 390560	— / —	Lg Rfl / 095316	—	#5 / 390947	Large	#4 / 392157	—
6.5X55	0.264	546282	I	046283	044106	—	—	046043	#19 / 390559	#19 / 392619	Lg Rfl / 095316	—	#5 / 390947	Large	#4 / 392157	B65X55
260 REM	0.264	546269	III	046441	044106	—	—	046043	#1 / 390541	#1 / 392601	Lg Rfl / 095316	—	#5 / 390947	Large	#4 / 392157	A260
6.5 CREEDMOOR	0.264	546289	I	046596	044135	—	—	046043	#1 / 390541	#1 / 392601	Lg Rfl / 095316	—	#5 / 390947	Large	#4 / 392157	A65C
6.5X57	0.264	546284	III	046285	044106	—	—	046043	#1 / 390541	#1 / 392601	Lg Rfl / 095316	—	#5 / 390947	Large	#4 / 392157	—
6.5-284	0.264	546301	III	046443	044106	—	—	046043	#1 / 390541	#1 / 392601	Lg Rfl / 095316	—	#5 / 390947	Large	#4 / 392157	B65
6.5-06	0.264	546280	III	046281	044123	—	—	046043	#1 / 390541	#1 / 392601	Lg Rfl / 095316	—	#5 / 390947	Large	#4 / 392157	—
6.5 REM MAG	0.264	546294	IV	—	—	—	—	046043	#5 / 390545	#5 / 392605	Lg Rfl / 095316	—	#5 / 390947	Large	#4 / 392157	—
6.5 PRC	0.264	546281	I	046284	044123	—	—	—	#5 / 390545	#5 / 392605	Lg Rfl / 095316	—	#5 / 390947	Large	#4 / 392157	B65P
264 WIN MAG	0.264	546278	III	046279	044123	—	—	046043	#5 / 390545	#5 / 392605	Lg Rfl / 095316	—	#5 / 390947	Large	#4 / 392157	A264
6.5X68	0.264	546286	III	046287	044123	—	—	046043	#30 / 390570	#30 / 392630	Lg Rfl / 095316	—	#5 / 390947	Large	#4 / 392157	—
26 NOSLER	0.264	546279	III	046280	044191	—	—	—	#5 / 390545	#5 / 392605	Lg Rfl / 095316	—	#5 / 390947	Large	#4 / 392157	B26N
6.5-300 WBY MAG	0.264	546283	IV	—	—	—	—	046043	#5 / 390545	#5 / 392605	Lg Rfl / 095316	—	#5 / 390947	Large	#4 / 392157	—
6.5X52 CARCANO	0.267	546288	III	046289	044134	—	—	046043	#21 / 390561	— / —	Lg Rfl / 095316	—	#5 / 390947	Large	#4 / 392157	—
6.8MM REM SPC	0.277	546299	III	046711	044713	—	—	—	#12 / 390552	#12 / 392612	Lg Rfl / 095316	—	#6 / 390948	Small	#5 / 392158	A68SPC
270 REN	0.277	—	—	—	—	—	—	—	#3 / 390543	#3 / 392603	Sm Rfl / 095314	—	#6 / 390948	Small	#5 / 392158	—
270 WIN	0.277	546300	I	046301	044107	—	—	046051	#1 / 390541	#1 / 392601	Lg Rfl / 095316	—	#6 / 390948	Large	#5 / 392158	A270
270 WSM	0.277	546297	I	046450	044161	—	—	046055	#35 / 390575	#35 / 392635	Lg Rfl / 095316	—	#6 / 390948	Large	#5 / 392158	B270W
270 WBY MAG	0.277	546298	III	046299	044107	—	—	046051	#5 / 390545	#5 / 392605	Lg Rfl / 095316	—	#6 / 390948	Large	#5 / 392158	B270
7MM-223 INGRAM	0.284	546318	IV	—	—	—	—	046049	#16 / 390556	#16 / 392616	Sm Rfl / 095314	—	#7 / 390949	Small	#6 / 392159	—
7MM TCU	0.284	546328	IV	—	—	—	—	046049	#16 / 390556	#16 / 392616	Sm Rfl / 095314	—	#7 / 390949	Small	#6 / 392159	—
7MM BR REM	0.284	546324	IV	—	—	—	—	046049	#1 / 390541	#1 / 392601	Sm Rfl / 095314	—	#7 / 390949	Large	#6 / 392159	A7MM*
7-30 WATERS	0.284	546304	IV	—	—	—	—	046049	#2 / 390542	#2 / 392602	Lg Rfl / 095316	—	#7 / 390949	Large	#6 / 392159	—
7X57	0.284	546308	III	046309	044133	—	—	046044	#1 / 390541	#1 / 392601	Lg Rfl / 095316	—	#7 / 390949	Large	#6 / 392159	A7X57
7X57R	0.284	546311	III	046310	044133	—	—	046044	#13 / 390553	#13 / 392613*	Lg Rfl / 095316	—	#7 / 390949	Large	#6 / 392159	—
7MM-08 REM	0.284	546316	I	046317	044108	—	—	046044	#1 / 390541	#1 / 392601	Lg Rfl / 095316	—	#7 / 390949	Large	#6 / 392159	A7MM08
284 WIN	0.284	546302	III	046303	044108	—	—	046044	#1 / 390541	#1 / 392601	Lg Rfl / 095316	—	#7 / 390949	Large	#6 / 392159	—
280 REM	0.284	546320	I	046321	044133	—	—	046044	#1 / 390541	#1 / 392601	Lg Rfl / 095316	—	#7 / 390949	Large	#6 / 392159	A280
280 ACKLEY IMP	0.284	546321	III	046304	044133	—	—	046044	#1 / 390541	#1 / 392601	Lg Rfl / 095316	—	#7 / 390949	Large	#6 / 392159	A280AI

*Discontinued SKUs with limited inventory.

RIFLE CARTRIDGE	Bullet Diameter (inches)	Die Set	Die Series	Full-Length Size Die	Seating Die	Expander Die	Taper Crimp Die Only	Neck Size Die	Shell Holder # / Item No.	Shell Plate # / Item No.	Case Feeder Plate Size / Item No.	Bullet Feeder Die	Trimmer Pilot # / Item No.	Primer Punch	Bullet Puller Collet # / Item No.	Modified Case
7X65R	0.284	546314	IV	—	—	—	—	046044	#13 / 390553	#13 / 392613*	Lg Rfl / 095316	—	#7 / 390949	Large	#6 / 392159	—
7X61 S&H	0.284	546310	IV	—	—	—	—	046044	#35 / 390575	#35 / 392635	Lg Rfl / 095316	—	#7 / 390949	Large	#6 / 392159	—
7X64	0.284	546312	IV	—	—	—	—	046044	#1 / 390541	#1 / 392601	Lg Rfl / 095316	—	#7 / 390949	Large	#6 / 392159	B764
7MM REM SA ULTRA MAG	0.284	546309	III	046452	044108	—	—	046056	#5 / 390545	#5 / 392605	Lg Rfl / 095316	—	#7 / 390949	Large	#6 / 392159	B7MMR
7MM REM MAG	0.284	546326	I	046327	044133	—	—	046044	#5 / 390545	#5 / 392605	Lg Rfl / 095316	—	#7 / 390949	Large	#6 / 392159	A7MMR
7MM WSM	0.284	546327	I	046451	044108	—	—	046056	#35 / 390575	#35 / 392635	Lg Rfl / 095316	—	#7 / 390949	Large	#6 / 392159	B7WS
7MM WBY MAG	0.284	546330	III	046331	044133	—	—	046044	#5 / 390545	#5 / 392605	Lg Rfl / 095316	—	#7 / 390949	Large	#6 / 392159	B7MMW
28 NOSLER	0.284	546329	III	046330	044133	—	—	046056	#5 / 390545	#5 / 392605	Lg Rfl / 095316	—	#7 / 390949	Large	#6 / 392159	B28N
7MM STW	0.284	546440	IV	—	—	—	—	046044	#5 / 390545	#5 / 392605	Lg Rfl / 095316	—	#7 / 390949	Large	#6 / 392159	—
7MM REM ULTRA MAG	0.284	546307	III	046454	044133	—	—	046056	#5 / 390545	#5 / 392605	Lg Rfl / 095316	—	#7 / 390949	Large	#6 / 392159	B7MM
7.35 CARCANO	0.3	546332	IV	—	—	—	—	—	#21 / 390561	— / —	Lg Rfl / 095316	—	#8 / 390950	Large	#7 / 392160	—
30 CARBINE	0.308	546503	II	046504	044142	044505	—	—	#22 / 390562	#22 / 392622	Sm Rfl / 095314	—	#9 / 390951	Small	#7 / 392160	—
30 REM	0.308	—	—	—	—	—	—	046050	#12 / 390552	#12 / 392612	Lg Rfl / 095316	095345	#9 / 390951	Large	#7 / 392160	—
300 BLACKOUT	0.308	546349	I	046459	044165	—	—	—	#16 / 390556	#16 / 392616	Sm Rfl / 095314	—	#9 / 390951	Small	#7 / 392160	A300A
30 HERRETT	0.308	546334	IV	—	—	—	—	046050	#2 / 390542	#2 / 392602	Lg Rfl / 095316	—	#9 / 390951	Large	#7 / 392160	—
30-30 WIN	0.308	546342	I	046343	044111	—	—	046050	#2 / 390542	#2 / 392602	Lg Rfl / 095316	095345	#9 / 390951	Large	#7 / 392160	A3030
30-30 ACKLEY IMP	0.308	546345	IV	—	—	—	—	046050	#2 / 390542	#2 / 392602	Lg Rfl / 095316	095345	#9 / 390951	Large	#7 / 392160	—
303 SAVAGE	0.308	546354	IV	—	—	—	—	046050	#33 / 390573	— / —	Lg Rfl / 095316	095345	#9 / 390951	Large	#7 / 392160	—
300 SAVAGE	0.308	546348	III	046349	044111	—	—	046050	#1 / 390541	#1 / 392601	Lg Rfl / 095316	095345	#9 / 390951	Large	#7 / 392160	B300S
30 MERRILL	0.308	546338	IV	—	—	—	—	046050	#4 / 390544	#4 / 392604	Lg Rfl / 095316	095345	#9 / 390951	Large	#7 / 392160	—
307 WIN	0.308	546358	I	046359	044111	—	—	046045	#33 / 390573	— / —	Lg Rfl / 095316	095345	#9 / 390951	Large	#7 / 392160	—
308 MARLIN EXP	0.308	546357	III	046358	044111	—	—	046045	#27 / 390567	#27 / 392627*	Lg Rfl / 095316	095345	#9 / 390951	Large	#7 / 392160	A308ME
7.5 SWISS (7.5X55)	0.308	546360	III	046361	044111	—	—	046045	#2 / 390542	#2 / 392602	Lg Rfl / 095316	095345	#9 / 390951	Large	#7 / 392160	—
7.5 SWISS K31	0.308	546361	III	046362	044111	—	—	046045	#2 / 390542	#2 / 392602	Lg Rfl / 095316	095345	#9 / 390951	Large	#7 / 392160	—
308 WIN	0.308	546358	I	046359	044111	—	—	046045	#1 / 390541	#1 / 392601	Lg Rfl / 095316	095345	#9 / 390951	Large	#7 / 392160	A308
7.62X54R	0.308	546362	III	046363	044111	—	—	046050	#23 / 390563	#23 / 392623	Lg Rfl / 095316	095345	#9 / 390951	Large	#7 / 392160	—
30-40 KRAG	0.308	546344	IV	—	—	—	—	046045	#11 / 390551	#11 / 392611	Lg Rfl / 095316	095345	#9 / 390951	Large	#7 / 392160	—
30 TC	0.308	546335	III	046336	044111	—	—	046045	#1 / 390541	#1 / 392601	Lg Rfl / 095316	095345	#9 / 390951	Large	#7 / 392160	A30TC
30-06 SPRG	0.308	546340	I	046341	044112	—	—	046045	#1 / 390541	#1 / 392601	Lg Rfl / 095316	095345	#9 / 390951	Large	#7 / 392160	A3006
30-06 ACKLEY IMP	0.308	546341	IV	—	—	—	—	046045	#1 / 390541	#1 / 392601	Lg Rfl / 095316	095345	#9 / 390951	Large	#7 / 392160	—
300 H&H MAG	0.308	546346	IV	—	—	—	—	046045	#5 / 390545	#5 / 392605	Lg Rfl / 095316	095345	#9 / 390951	Large	#7 / 392160	A300H
300 OLYMPIC	0.308	546355	IV	—	—	—	—	—	#35 / 390575	#35 / 392635	Lg Rfl / 095316	—	#9 / 390951	Large	#7 / 392160	—
300 REM SA ULTRA MAG	0.308	546347	III	046455	044160	—	—	046057	#5 / 390545	#5 / 392605	Lg Rfl / 095316	095345	#9 / 390951	Large	#7 / 392160	B300R
308 NORMA MAG	0.308	546356	IV	—	—	—	—	046045	#5 / 390545	#5 / 392605	Lg Rfl / 095316	095345	#9 / 390951	Large	#7 / 392160	—
300 RCM	0.308	546353	III	046592	044111	—	—	046057	#5 / 390545	#5 / 392605	Lg Rfl / 095316	095345	#9 / 390951	Large	#7 / 392160	A300R
300 WSM	0.308	546369	I	046453	044160	—	—	046057	#35 / 390575	#35 / 392635	Lg Rfl / 095316	095345	#9 / 390951	Large	#7 / 392160	B300W
300 WIN MAG	0.308	546352	I	046353	044112	—	—	046045	#5 / 390545	#5 / 392605	Lg Rfl / 095316	095345	#9 / 390951	Large	#7 / 392160	A300M
300 WBY MAG	0.308	546350	I	046351	044112	—	—	046045	#5 / 390545	#5 / 392605	Lg Rfl / 095316	095345	#9 / 390951	Large	#7 / 392160	A300W
30 NOSLER	0.308	546337	IV	—	—	—	—	046057	#5 / 390545	#5 / 392605	Lg Rfl / 095316	095345	#9 / 390951	Large	#7 / 392160	B30N
300 PRC	0.308	546351	I	046334	044157	—	—	046057	#5 / 390545	#5 / 392605	Lg Rfl / 095316	095345	#9 / 390951	Large	#7 / 392160	B300P
300 REM ULTRA MAG	0.308	546365	III	046447	044159	—	—	046057	#5 / 390545	#5 / 392605	Lg Rfl / 095316	095345	#9 / 390951	Large	#7 / 392160	B300
30-378 WBY MAG	0.308	546419	IV	—	—	—	—	046057	#14 / 390554	#14 / 392614	Lg Rfl / 095316	095345	#9 / 390951	Large	#7 / 392160	C30378
7.62X39	0.308	546424	I	046425	044126	—	—	—	#6 / 390546	#6 / 392606	Sm Rfl / 095314	—	#9 / 390951	Large	#7 / 392160	A762

*Discontinued SKUs with limited inventory.

RIFLE CARTRIDGE	Bullet Diameter (inches)	Die Set	Die Series	Full-Length Size Die	Seating Die	Expander Die	Taper Crimp Die Only	Neck Size Die	Shell Holder # / Item No.	Shell Plate # / Item No.	Case Feeder Plate Size / Item No.	Bullet Feeder Die	Trimmer Pilot # / Item No.	Primer Punch	Bullet Puller Collet # / Item No.	Modified Case
32-20 WIN	0.312	546364	III	046365	044113	—	—	—	#7 / 390547	#7 / 392607	Sm Rfl / 095314	—	#9 / 390951	Small	#7 / 392160	—
7.65 BELG	0.312	546368	III	046369	044114	—	—	—	#24 / 390564	— / —	Lg Rfl / 095316	—	#10 / 390952	Large	#7 / 392160	—
303 BRITISH	0.312	546366	III	046367	044114	—	—	—	#11 / 390551	#11 / 392611	Lg Rfl / 095316	—	#10 / 390952	Large	#7 / 392160	A303
7.7 JAP	0.312	546370	III	046371	044114	—	—	—	#1 / 390541	#1 / 392601	Lg Rfl / 095316	—	#10 / 390952	Large	#7 / 392160	—
32-40 WIN	0.321	546374	IV	—	—	—	—	—	#2 / 390542	#2 / 392602	Lg Rfl / 095316	—	#11 / 390953	Large	#8 / 392161	—
32 WIN SPL	0.321	546372	IV	—	—	—	—	—	#2 / 390542	#2 / 392602	Lg Rfl / 095316	—	#11 / 390953	Large	#8 / 392161	A32
32 REM	0.321	—	—	—	—	—	—	—	#12 / 390552	#12 / 392612	Lg Rfl / 095316	—	#12 / 390954	Large	#8 / 392161	—
8.15X46R	0.321	546386	IV	—	—	—	—	—	#2 / 390542	#2 / 392602	Lg Rfl / 095316	—	#11 / 390953	Large	#8 / 392161	—
7.92X33 KURZ	0.323	546375	III	046376	044137	—	—	—	#1 / 390541	#1 / 392601	Sm Rfl / 095314	—	#11 / 390953	Large	#8 / 392161	—
8X57	0.323	546382	III	046383	044116	—	—	—	#1 / 390541	#1 / 392601	Lg Rfl / 095316	—	#11 / 390953	Large	#8 / 392161	A8X57
8X57 JRS	0.323	546382	III	046383	044116	—	—	—	#13 / 390553	#13 / 392613*	Lg Rfl / 095316	—	#11 / 390953	Large	#8 / 392161	—
8X57 JS	0.323	546382	III	046383	044116	—	—	—	#1 / 390541	#1 / 392601	Lg Rfl / 095316	—	#11 / 390953	Large	#8 / 392161	A8X57
8X60S	0.323	546376	III	046377	044116	—	—	—	#1 / 390541	#1 / 392601	Lg Rfl / 095316	—	#11 / 390953	Large	#8 / 392161	—
325 WSM	0.323	546387	IV	—	—	—	—	—	#35 / 390575	#35 / 392635	Lg Rfl / 095316	—	#11 / 390953	Large	#8 / 392161	—
8X68S	0.323	546378	IV	—	—	—	—	—	#30 / 390570	#30 / 392630	Lg Rfl / 095316	—	#11 / 390953	Large	#8 / 392161	—
8MM REM MAG	0.323	546384	IV	—	—	—	—	—	#5 / 390545	#5 / 392605	Lg Rfl / 095316	—	#11 / 390953	Large	#8 / 392161	A8MM
8X56 HUNGARIAN-MANN	0.329	546385	IV	—	—	—	—	—	#47 / 390603	— / —	Lg Rfl / 095316	—	#11 / 390953	Large	#8 / 392161	—
338 FEDERAL	0.338	546397	III	046595	044131	—	—	046058	#1 / 390541	#1 / 392601	Lg Rfl / 095316	—	#13 / 390955	Large	#9 / 392162	—
338 MARLIN EXP	0.338	546359	III	046597	044131	—	—	046058	#52 / 390607	#52 / 392652*	Lg Rfl / 095316	—	#13 / 390955	Large	#9 / 392162	A338M
338 RCM	0.338	546399	III	046594	044131	—	—	046058	#5 / 390545	#5 / 392605	Lg Rfl / 095316	—	#13 / 390955	Large	#9 / 392162	A338R
338 WIN MAG	0.338	546390	I	046391	044117	—	—	046058	#5 / 390545	#5 / 392605	Lg Rfl / 095316	—	#13 / 390955	Large	#9 / 392162	A338
33 NOSLER	0.338	546381	IV	—	—	—	—	046058	#5 / 390545	#5 / 392605	Lg Rfl / 095316	—	#13 / 390955	Large	#9 / 392162	B33N
338 NORMA MAG	0.338	—	—	—	—	—	—	046058	#43 / 390583	— / —	Lg Rfl / 095316	—	#13 / 390955	Large	#9 / 392162	—
340 WBY MAG	0.338	546392	IV	—	—	—	—	046058	#5 / 390545	#5 / 392605	Lg Rfl / 095316	—	#13 / 390955	Large	#9 / 392162	A340
338 REM ULTRA MAG	0.338	546389	III	046446	044117	—	—	046058	#5 / 390545	#5 / 392605	Lg Rfl / 095316	—	#13 / 390955	Large	#9 / 392162	B338
338 LAPUA MAG	0.338	546393	III	046593	044117	—	—	046058	#43 / 390583	— / —	Lg Rfl / 095316	—	#13 / 390955	Large	#9 / 392162	C338L
338-378 WBY MAG	0.338	546391	IV	—	—	—	—	046058	#14 / 390554	#14 / 392614	Lg Rfl / 095316	—	#13 / 390955	Large	#9 / 392162	—
348 WIN	0.348	546394	IV	—	—	—	—	—	#25 / 390565	#25 / 392625*	Lg Rfl / 095316	—	#14 / 390956	Large	#9 / 392162	—
350 LEGEND	0.355	546401	V	046396	044125	045507	045800	—	#16 / 390556	#16 / 392616	Sm Rfl / 095314	—	#15 / 390957	Small	#9 / 392162	A350L
35 REM	0.358	546398	III	046399	044130	—	—	—	#26 / 390566	— / —	Lg Rfl / 095316	—	#15 / 390957	Large	#9 / 392162	A35R
356 WIN	0.358	—	—	—	—	—	—	046046	#33 / 390573	— / —	Lg Rfl / 095316	—	#15 / 390957	Large	#9 / 392162	—
358 WIN	0.358	546408	IV	—	—	—	—	046046	#1 / 390541	#1 / 392601	Lg Rfl / 095316	—	#15 / 390957	Large	#9 / 392162	B358
350 REM MAG	0.358	546402	IV	—	—	—	—	—	#5 / 390545	#5 / 392605	Lg Rfl / 095316	—	#15 / 390957	Large	#9 / 392162	A350
35 WHELEN	0.358	546400	III	046401	044119	—	—	046046	#1 / 390541	#1 / 392601	Lg Rfl / 095316	—	#15 / 390957	Large	#9 / 392162	A35
358 NORMA MAG	0.358	546406	IV	—	—	—	—	046046	#5 / 390545	#5 / 392605	Lg Rfl / 095316	—	#15 / 390957	Large	#9 / 392162	—
9.3X57	0.366	546410	III	046411	044120	—	—	—	#1 / 390541	#1 / 392601	Lg Rfl / 095316	—	#20 / 390962	Large	#9 / 392162	—
9.3X74R	0.366	546414	III	046415	044120	—	—	—	#13 / 390553	#13 / 392613*	Lg Rfl / 095316	—	#20 / 390962	Large	#9 / 392162	C9374
9.3X62	0.366	546412	III	046413	044120	—	—	—	#1 / 390541	#1 / 392601	Lg Rfl / 095316	—	#20 / 390962	Large	#9 / 392162	A9362
38-55 WIN	0.375	546537	IV	—	—	—	—	—	#2 / 390542	#2 / 392602	Lg Rfl / 095316	—	#16 / 390958	Large	#10 / 392163	—
375 WIN	0.375	546530	IV	—	—	—	—	—	#2 / 390542	#2 / 392602	Lg Rfl / 095316	—	#16 / 390958	Large	#10 / 392163	—
376 STEYR	0.375	546417	IV	—	—	—	—	—	#15 / 390555	#15 / 392615*	Lg Rfl / 095316	—	#16 / 390958	Large	#10 / 392163	—
375 FL MAG NITRO EXP	0.375	546449	IV	—	—	—	—	—	#43 / 390583	— / —	Lg Rfl / 095316	—	#16 / 390958	Large	#10 / 392163	—
375 RUGER	0.375	546415	I	046418	044121	—	—	—	#5 / 390545	#5 / 392605	Lg Rfl / 095316	—	#16 / 390958	Large	#10 / 392163	C375R

*Discontinued SKUs with limited inventory.

RIFLE CARTRIDGE	Bullet Diameter (inches)	Die Set	Die Series	Full-Length Size Die	Seating Die	Expander Die	Taper Crimp Die Only	Neck Size Die	Shell Holder # / Item No.	Shell Plate # / Item No.	Case Feeder Plate Size / Item No.	Bullet Feeder Die	Trimmer Pilot # / Item No.	Primer Punch	Bullet Puller Collet # / Item No.	Modified Case
375 H&H MAG	0.375	546416	III	046417	044121	—	—	—	#5 / 390545	#5 / 392605	Lg Rfl / 095316	—	#16 / 390958	Large	#10 / 392163	A375
375 REM ULTRA MAG	0.375	546450	IV	—	—	—	—	—	#5 / 390545	#5 / 392605	Lg Rfl / 095316	—	#16 / 390958	Large	#10 / 392163	—
378 WBY MAG	0.375	546418	IV	—	—	—	—	—	#14 / 390554	#14 / 392614	Lg Rfl / 095316	—	#16 / 390958	Large	#10 / 392163	B378
450-400 NITRO EXP 3"	0.41	546421	IV	—	—	—	—	—	#25 / 390565	#25 / 392625*	Lg Rfl / 095316	—	#17 / 390959	Large	#11 / 392164	C450*
405 WIN	0.411	546425	II	046456	044162	044571	—	—	#42 / 390582	— / —	Lg Rfl / 095316	—	#17 / 390959	Large	#11 / 392164	C405
10.3X60R SWISS	0.415	546420	IV	—	—	—	—	—	#25 / 390565	#25 / 392625*	Lg Rfl / 095316	—	#17 / 390959	Large	#11 / 392164	—
416 RUGER	0.416	546429	IV	—	—	—	—	—	#5 / 390545	#5 / 392605	Lg Rfl / 095316	—	#17 / 390959	Large	#11 / 392164	C416R*
416 REM MAG	0.416	546426	IV	—	—	—	—	—	#5 / 390545	#5 / 392605	Lg Rfl / 095316	—	#17 / 390959	Large	#11 / 392164	A416
416 RIGBY	0.416	546428	IV	—	—	—	—	—	#38 / 390578	— / —	Lg Rfl / 095316	—	#17 / 390959	Large	#11 / 392164	C416R
416 WBY MAG	0.416	546430	IV	—	—	—	—	—	#14 / 390554	#14 / 392614	Lg Rfl / 095316	—	#17 / 390959	Large	#11 / 392164	—
404 JEFFERY	0.423	546423	IV	—	—	—	—	—	#53 / 390608	— / —	Lg Rfl / 095316	—	#17 / 390959	Large	#12 / 392165	—
444 MARLIN	0.43	546551	II	046552	044149	044553	—	—	#27 / 390567	#27 / 392627*	Lg Rfl / 095316	—	#18 / 390960	Large	#12 / 392165	—
450 BUSHMASTER	0.452	546452	V	046422	044721	044550	044176	—	#1 / 390541	#1 / 392601	Lg Rfl / 095316	—	#19 / 390961	Large	#13 / 392166	A450B
458 SOCOM	0.458	546464	III	046424	044190	—	—	—	#1 / 390541	#1 / 392601	Lg Rfl / 095316	—	#19 / 390961	Small	#13 / 392166	—
45-70 GOVT	0.458	546566	II	046567	044152	044568	—	—	#14 / 390554	#14 / 392614	Lg Rfl / 095316	—	#19 / 390961	Large	#13 / 392166	A4570
450 MARLIN	0.458	546553	II	046587	044152	044568	—	—	#5 / 390545	#5 / 392605	Lg Rfl / 095316	—	#19 / 390961	Large	#13 / 392166	—
450 NITRO EXP 3¼"	0.458	546433	IV	—	—	—	—	—	#54 / 390609	— / —	N/A	—	#19 / 390961	Large	#13 / 392166	C450NE*
458 WIN MAG	0.458	546569	II	046570	044153	044568	—	—	#5 / 390545	#5 / 392605	Lg Rfl / 095316	—	#19 / 390961	Large	#13 / 392166	C458W
458 LOTT	0.458	546465	II	046457	044204	044572	—	—	#5 / 390545	#5 / 392605	Lg Rfl / 095316	—	#19 / 390961	Large	#13 / 392166	C458L
460 WBY MAG	0.458	546422	IV	—	—	—	—	—	#14 / 390554	#14 / 392614	Lg Rfl / 095316	—	#19 / 390961	Large	#13 / 392166	—
470 NITRO EXP 3¼"	0.474	546434	IV	—	—	—	—	—	#55 / 390610	— / —	N/A	—	#23 / 390939	Large	— / —	C470N*
50-70 GOVT	0.51	546462	IV	—	—	—	—	—	— / —	— / —	Lg Rfl / 095316	—	#50 / 390937	Large	— / —	—
50 ALASKAN	0.51	546586	IV	—	—	—	—	—	#25 / 390565	#25 / 392625*	Lg Rfl / 095316	—	#50 / 390937	Large	— / —	—
500 NITRO EXP 3"	0.51	546435	IV	—	—	—	—	—	#55 / 390610	— / —	N/A	—	#50 / 390937	Large	— / —	C500N*

*Discontinued SKUs with limited inventory.

FREE BALLISTIC APP WITH 4DOF®

Our free Hornady Ballistic Calculator App includes the advanced 4DOF® calculator as well as a standard BC calculator. Providing more accurate trajectory solutions, the 4DOF® calculator incorporates the projectile's movement in the standard 3 degrees but also adds its movement about its center of gravity and subsequent angle relative to its line of flight, which is the fourth degree of freedom.

- Calculates more accurate trajectories, especially at extreme ranges
- Can be used without wireless connectivity
- Pre-populated with long range match and hunting style bullets
- Includes spin drift, aerodynamic jump, and other calculations not available on traditional ballistic calculators.

Search Apple and Android app stores



PISTOL CARTRIDGE	Bullet Diameter (inches)	Die Set	Die Series	Full-Length Size Die	Seating Die	Expander Die	Taper Crimp Seater Die	Taper Crimp Die Only	Shell Holder # / Item No.	Shell Plate # / Item No.	Case Feeder Plate Size / Item No.	Bullet Feeder Die	Trimmer Pilot # / Item No.	Primer Punch
22 TCM	0.224	546215	IV	—	—	—	—	—	#16 / 390556	#16 / 392616	— / —	—	#1 / 390943	Small
25 AUTO	0.251	—	—	—	—	—	—	—	#37 / 390577	— / —	Sm Pstl / 095310	N/A	#4 / 390946	Small
30 LUGER	0.308	546336	IV	—	—	—	—	—	#8 / 390548	#8 / 392608	Sm Pstl / 095310	N/A	#9 / 390951	Small
30 MAUSER	0.309	—	—	—	—	—	—	—	#8 / 390548	#8 / 392608	Sm Pstl / 095310	N/A	#9 / 390951	Small
32 AUTO	0.311	546506	II	046507	044113	044508	—	—	#22 / 390562	#22 / 392622	Sm Pstl / 095310	N/A	#10 / 390952	Small
32 S&W LONG	0.312	546509	II	046510	044143	044511	—	—	#36 / 390576	#36 / 392636	Sm Pstl / 095310	N/A	#10 / 390952	Small
32 H&R MAG	0.312	546509	II	046510	044143	044511	—	—	#36 / 390576	#36 / 392636	Sm Pstl / 095310	N/A	#10 / 390952	Small
327 FEDERAL MAG	0.312	546509	II	046510	044143	044511	—	—	#36 / 390576	#36 / 392636	Sm Pstl / 095310	N/A	#10 / 390952	Small
7.5 SWISS ORDNANCE	0.312	546504	IV	—	—	—	—	—	#48 / 390604	— / —	Sm Pstl / 095310	N/A	#10 / 390952	Small
8MM LABEL REVOLVER	0.326	546510	IV	—	—	—	—	—	#48 / 390604	— / —	Lg Pstl / 095312	N/A	#11 / 390953	Large
380 AUTO	0.355	546518	II	046519	044144	044517	—	044170	#16 / 390556	#16 / 392616	Sm Pstl / 095310	095330	#15 / 390957	Small
9MM LUGER TAPER CRIMP	0.355	546516	II	046516	044177	044517	044177	—	#8 / 390548	#8 / 392608	Sm Pstl / 095310	095330	#15 / 390957	Small
9MM LUGER	0.355	546515	II	046516	044144	044517	—	044170	#8 / 390548	#8 / 392608	Sm Pstl / 095310	095330	#15 / 390957	Small
9X21 TAPER CRIMP	0.355	546516	II	046516	044177	044517	044177	—	#8 / 390548	#8 / 392608	Sm Pstl / 095310	095330	#15 / 390957	Small
9X21	0.355	546515	II	046516	044144	044517	—	044170	#8 / 390548	#8 / 392608	Sm Pstl / 095310	095330	#15 / 390957	Small
38 SUPER AUTO	0.355	546524	II	046525	044144	044526	—	—	#8 / 390548	#8 / 392608	Sm Pstl / 095310	N/A	#15 / 390957	Small
357 SIG	0.355	546575	II	046576	044150	044577	—	—	#10 / 390550	#10 / 392610	Sm Pstl / 095310	N/A	#15 / 390957	Small
9X23 WIN	0.355	546532	IV	—	—	—	—	—	#8 / 390548	#8 / 392608	Sm Pstl / 095310	N/A	#15 / 390957	Small
38 SPL	0.357	546527	II	046528	044145	044523	—	—	#6 / 390546	#6 / 392606	Lg Pstl / 095312	095331	#15 / 390957	Small
COWBOY 38 SPL	0.357	546528	III	046528	044169	044591	—	—	#6 / 390546	#6 / 392606	Lg Pstl / 095312	N/A	#15 / 390957	Small
357 MAGNUM	0.357	546527	II	046528	044145	044523	—	—	#6 / 390546	#6 / 392606	Lg Pstl / 095312	095331	#15 / 390957	Small
COWBOY 357 MAGNUM	0.357	546528	III	046528	044169	044591	—	—	#6 / 390546	#6 / 392606	Lg Pstl / 095312	N/A	#15 / 390957	Small
357 REM MAX	0.357	546527	II	046528	044145	044523	—	—	#6 / 390546	#6 / 392606	Lg Pstl / 095312	095331	#15 / 390957	Small
COWBOY 357 REM MAX	0.357	546528	III	046528	044169	044591	—	—	#6 / 390546	#6 / 392606	Lg Pstl / 095312	N/A	#15 / 390957	Small
38 S&W	0.357	546521	IV	—	—	—	—	—	#28 / 390568	#28 / 392628*	Lg Pstl / 095312	N/A	#15 / 390957	Large
357 HERRETT	0.357	546396	IV	—	—	—	—	—	#2 / 390542	#2 / 392602	Lg Pstl / 095312	N/A	#15 / 390957	Large
9X18 MAKAROV	0.364	546512	II	046513	044154	044514	—	—	#8 / 390548	#8 / 392608	Sm Pstl / 095310	N/A	#15 / 390957	Small
38-40 WIN	0.400	546536	IV	—	—	—	—	—	#9 / 390549	#9 / 392609	Lg Pstl / 095312	N/A	#21 / 390941	Large
40 S&W TAPER CRIMP	0.400	546534	II	046534	044178	044535	044178	—	#10 / 390550	#10 / 392610	Lg Pstl / 095312	095332	#21 / 390941	Small
40 S&W	0.400	546533	II	046534	044146	044535	—	044171	#10 / 390550	#10 / 392610	Lg Pstl / 095312	095332	#21 / 390941	Small
10MM AUTO TAPER CRIMP	0.400	546534	II	046534	044178	044535	044178	—	#10 / 390550	#10 / 392610	Lg Pstl / 095312	095332	#21 / 390941	Large
10MM AUTO	0.400	546533	II	046534	044146	044535	—	044171	#10 / 390550	#10 / 392610	Lg Pstl / 095312	095332	#21 / 390941	Large
400 COR-BON	0.400	546538	IV	—	—	—	—	—	#45 / 390606	#45 / 392645	Lg Pstl / 095312	N/A	#21 / 390941	Large
41 AE	0.410	546539	II	046540	044147	044541	—	—	#8 / 390548	#8 / 392608	Lg Pstl / 095312	N/A	#17 / 390959	Small
41 REM MAG	0.410	546539	II	046540	044147	044541	—	—	#29 / 390569	#29 / 392629	Lg Pstl / 095312	N/A	#17 / 390959	Large
COWBOY 44-40 WIN	0.429	546543	III	046460	044166	044593	—	—	#9 / 390549	#9 / 392609	Lg Pstl / 095312	N/A	#18 / 390960	Large
44 SPL	0.430	546548	II	046549	044148	044544	—	—	#30 / 390570	#30 / 392630	Lg Pstl / 095312	095333	#18 / 390960	Large
COWBOY 44 SPL	0.430	546549	III	046549	044166	044592	—	—	#30 / 390570	#30 / 392630	Lg Pstl / 095312	N/A	#18 / 390960	Large
44 REM MAG	0.430	546548	II	046549	044148	044544	—	—	#30 / 390570	#30 / 392630	Lg Pstl / 095312	095333	#18 / 390960	Large
44 AUTO MAG	0.430	546545	IV	—	—	—	—	—	#1 / 390541	#1 / 392601	Lg Pstl / 095312	095333	#18 / 390960	Large
445 SUPER MAG	0.430	—	—	—	—	—	—	—	#30 / 390570	#30 / 392630	Lg Pstl / 095312	N/A	#18 / 390960	Large
45 AUTO TAPER CRIMP	0.451	546555	II	046555	044179	044556	044179	—	#45 / 390606	#45 / 392645	Lg Pstl / 095312	095334	#19 / 390961	Large
45 AUTO	0.451	546554	II	046555	044151	044556	—	044172	#45 / 390606	#45 / 392645	Lg Pstl / 095312	095334	#19 / 390961	Large
45 AUTO RIMMED	0.451	546554	II	046555	044151	044556	—	044172	#31 / 390571	— / —	Lg Pstl / 095312	095334	#19 / 390961	Large
45 WIN MAG	0.451	546554	II	046555	044151	044556	—	044172	#1 / 390541	#1 / 392601	Lg Pstl / 095312	095334	#19 / 390961	Large
45 S&W SCHOFIELD	0.452	546546	IV	—	—	—	—	—	#41 / 390581	— / —	Lg Pstl / 095312	095334	#19 / 390961	Large
45 COLT	0.452	546582	II	046583	044151	044556	—	—	#32 / 390572	#32 / 392632	Lg Pstl / 095312	095334	#19 / 390961	Large
COWBOY 45 COLT	0.452	546581	III	046583	044168	044594	—	—	#32 / 390572	#32 / 392632	Lg Pstl / 095312	095334	#19 / 390961	Large
454 CASULL	0.452	546584	V	046584	044151	044556	—	044588	#32 / 390572	#32 / 392632	Lg Pstl / 095312	095334	#19 / 390961	Small
460 S&W MAG	0.452	546583	V	046720	044721	044719	—	044722	#46 / 390602	#46 / 392646	Lg Rfl / 095316	095334	#19 / 390961	Large
455 WEBLEY	0.455	—	—	—	—	—	—	—	#51 / 390601	— / —	Lg Pstl / 095312	N/A	#19 / 390961	Large
475 LINEBAUGH	0.475	546547	V	046585	044158	044586	—	044174	#14 / 390554	#14 / 392614	Lg Pstl / 095312	N/A	#23 / 390939	Large
480 RUGER	0.475	546547	V	046585	044158	044586	—	044174	#14 / 390554	#14 / 392614	Lg Pstl / 095312	N/A	#23 / 390939	Large
50 AE	0.500	546580	II	046581	044155	044582	—	—	#40 / 390580	#40 / 392640	Lg Rfl / 095316	N/A	#50 / 390937	Large
500 S&W MAG	0.500	546585	V	046699	044700	044701	—	044702	#44 / 390584	#44 / 392644	Lg Rfl / 095316	N/A	#50 / 390937	Large
500 LINEBAUGH	0.510	546587	IV	—	—	—	—	—	#25 / 390565	#25 / 392625*	Lg Rfl / 095316	N/A	#50 / 390937	Large

*Discontinued SKUs with limited inventory.

Rifle Ammunition Product Lines:

AG American Gunner™
AW American Whitetail®
CD Critical Defense®

C Custom™
CL Custom Lite®
DG Dangerous Game™ Series

B Hornady BLACK®
LEV LEVERevolution®
M Match™

O Outfitter®
PH Precision Hunter®
SUB Subsonic

SF Superformance®
SM Superformance® Match
SV Superformance® Varmint

V Varmint Express®
VM Vintage Match™

Hornady® Bullet Types:

A-MAX®
BT Boattail
BTHP . . Boattail Hollow Point
DGS . . . Dangerous Game Solid
DGX . . . Dangerous Game™
 eXpanding

ELD-X® Extremely Low
 Drag - eXpanding
ELD® Match
FMJ . . . Full Metal Jacket
FP Flat Point
FPB . . . Flex Tip® Projectile
 Blackpowder

FTX . . . Flex Tip® eXpanding
GMX . . . Copper Alloy eXpanding
HD SBR Heavy Duty Short-
 Barreled Rifle
HP Hollow Point
InterBond®
L Swaged Lead Bullet

LRN . . . Lead Round Nose
ML Muzzleloading
MonoFlex®
NTX . . . Non-Traditional
 eXpanding
OTM . . . Open-Tip Match
RN Round Nose

SJ Short Jacket
SP Spire Point
SPF Superformance®
SP-RP . . Spire Point Recoil Proof
SST Super Shock Tip
Sub-X® . Subsonic eXpanding

V Vented
V-MAX®
W/C . . . With Cannelure
XTP . . . eXtreme Terminal
 Performance™

Rifle Ballistics

Ammo Description			Velocity (fps)							Energy (ft/lb)							Trajectory Tables (inches)				
CARTRIDGE	BULLET	ITEM #	MUZ	100 yd	200 yd	300 yd	400 yd	500 yd	MUZ	100 yd	200 yd	300 yd	400 yd	500 yd	MUZ	100 yd	200 yd	300 yd	400 yd	500 yd	
V	17 Mach 2	15.5 gr. NTX®	83176	2050	1450	1070	—	—	—	145	72	39	—	—	—	-1.5	0	-15.6	—	—	—
V	17 Mach 2	17 gr. V-MAX®	83177	2100	1531	1133	—	—	—	166	88	48	—	—	—	-1.5	0	-13.8	—	—	—
V	17 HMR	15.5 gr. NTX®	83171	2525	1830	1291	—	—	—	219	115	57	—	—	—	-1.5	0	-10	—	—	—
V	17 HMR	17 gr. V-MAX®	83170	2550	1902	1379	—	—	—	245	137	72	—	—	—	-1.5	0	-8.5	—	—	—
V	17 HMR	20 gr. XTP®	83172	2375	1755	1274	—	—	—	250	137	72	—	—	—	-1.5	0	-9.9	—	—	—
V	17 WSM	20 gr. V-MAX®	83180	3000	2504	2058	—	—	—	400	278	188	—	—	—	-1.5	0	-4.1	—	—	—
SV	17 Hornet	20 gr. V-MAX®	83005	3650	3077	2574	2122	1721	1383	592	420	294	200	132	85	-1.5	1.1	0	-6.4	-20.7	-46.9
SV	204 Ruger	24 gr. NTX® (26" Bbl)	83209	4400	3667	3046	2504	2023	1604	1032	717	494	334	218	137	-1.5	0.6	0	-4.3	-14.3	-33.0
SV	204 Ruger	32 gr. V-MAX® (26" Bbl)	83204	4225	3645	3137	2685	2275	1903	1268	944	699	512	368	257	-1.5	0.6	0	-4.1	-13.1	-28.9
SV	204 Ruger	40 gr. V-MAX® (26" Bbl)	83206	3900	3482	3104	2757	2435	2136	1351	1077	855	675	527	405	-1.5	0.7	0	-4.3	-13.2	-28.0
V	22 WMR	30 gr. V-MAX®	83202	2200	1454	1026	—	—	—	322	141	70	—	—	—	-1.5	0	-15.7	—	—	—
V	22 Hornet	35 gr. V-MAX®	8302	3070	2247	1574	1117	918	802	732	392	192	97	65	50	-1.5	2.9	0	-17.5	-62.7	-149.2
C	22 Hornet	45 gr. SP	83028	2665	2241	1858	1523	1252	1071	710	502	345	232	157	115	-1.5	2.8	0	-13.0	-41.2	-91.6
C	218 Bee	45 gr. HP Match™	8307	2750	1974	1362	1019	867	763	756	389	185	104	75	58	-1.5	3.9	0	-23.2	-79.6	-182.3
SV	222 Rem	35 gr. NTX®	8309	3760	3148	2615	2140	1719	1369	1099	770	531	356	230	146	-1.5	1.0	0	-6.2	-20.1	-46.0
SV	222 Rem	50 gr. V-MAX®	8316	3345	2930	2553	2205	1886	1599	1242	953	723	540	395	284	-1.5	1.3	0	-6.7	-20.6	-44.3
B	5.45 x 39mm	60 gr. V-MAX® (16" Bbl)	81247	2810	2495	2202	1929	1679	1457	1052	830	646	496	376	283	-1.8	1.9	0	-9.1	-27.7	-58.6
SV	223 Rem	35 gr. NTX®	83266	4000	3353	2796	2302	1861	1483	1243	874	607	412	269	171	-1.5	0.8	0	-5.3	-17.3	-39.6
SV	223 Rem	53 gr. V-MAX®	8025	3465	3106	2776	2470	2183	1916	1413	1135	907	718	561	432	-1.5	1.1	0	-5.6	-16.9	-35.6
CD	223 Rem	55 gr. FTX®	80270	3240	2690	2201	1768	—	—	1282	883	592	382	—	—	-1.5	0	-3.4	-14.1	—	—
AG	223 Rem	55 gr. HP Match™	80237	3240	2802	2405	2042	1713	1429	1282	959	706	509	358	249	-1.5	1.5	0	-7.6	-23.6	-51.5
C	223 Rem	55 gr. SP	80255																		

All data from a 24" Bbl, unless otherwise noted.

Ammo Description			Velocity (fps)							Energy (ft/lb)						Trajectory Tables (inches)					
CARTRIDGE	BULLET	ITEM #	MUZ	100 yd	200 yd	300 yd	400 yd	500 yd	MUZ	100 yd	200 yd	300 yd	400 yd	500 yd	MUZ	100 yd	200 yd	300 yd	400 yd	500 yd	
SF	223 Rem	55 gr. GMX®	83274	3250	2849	2482	2144	1834	1557	1290	991	753	561	411	296	-1.5	1.4	0	-7.1	-21.8	-47.0
V	223 Rem	55 gr. V-MAX®	8327	3240	2855	2502	2175	1873	1602	1282	995	764	578	429	313	-1.5	1.4	0	-7.0	-21.4	-45.8
B	223 Rem	62 gr. FMJ	80234	3100	2751	2428	2127	1849	1597	1323	1042	811	623	471	351	-1.5	1.6	0	-7.5	-22.7	-48.2
CD	223 Rem	73 gr. FTX®	80260	2790	2448	2131	1839	—	—	1262	971	736	548	—	—	-1.5	0	-4.4	-16.4	—	—
M	223 Rem	73 gr. ELD® Match	80269	2790	2563	2348	2143	1949	1766	1262	1065	894	744	616	505	-1.5	1.9	0	-8.2	-24.0	-49.0
B	223 Rem	75 gr. BTHP	80267	2790	2562	2345	2139	1943	1759	1296	1093	916	762	629	515	-1.5	1.9	0	-8.2	-24.1	-49.3
M	223 Rem	75 gr. BTHP	8026	2790	2562	2345	2139	1943	1759	1296	1093	916	762	629	515	-1.5	1.9	0	-8.2	-24.1	-49.3
SM	223 Rem	75 gr. BTHP	80264	2930	2695	2471	2259	2057	1866	1430	1209	1017	850	705	580	-1.5	1.7	0	-7.4	-21.6	-44.0
SF	5.56 NATO	55 gr. GMX® (20" Bbl)	81254	3130	2740	2382	2051	1750	1484	1196	917	693	514	374	269	-2.4	1.1	0	-7.3	-23.0	-50.1
B	5.56 NATO	62 gr. FMJ (20" Bbl)	81263	3060	2714	2394	2095	1820	1571	1289	1014	789	604	456	340	-1.5	1.6	0	-7.7	-23.4	-49.7
SM	5.56 NATO	75 gr. BTHP (20" Bbl)	81264	2910	2676	2453	2242	2041	1851	1410	1192	1002	837	693	570	-2.4	1.2	0	-7.0	-21.0	-43.3
B	5.56 NATO	75 gr. InterLock® HD SBR™ (20" Bbl)	81296	2310	1695	1654	1387	1179	1042	889	643	456	321	231	181	-2.5	3.3	0	-16.1	-50.5	-109.9
V	224 Valkyrie	60 gr. V-MAX® W/C	81531	3300	2924	2578	2258	1961	1690	1451	1139	885	679	512	380	-1.5	1.3	0	-6.6	-20.0	-42.6
B	224 Valkyrie	75 gr. BTHP W/C	81532	3000	2761	2534	2319	2114	1920	1499	1269	1070	896	744	614	-1.5	1.5	0	-7.0	-20.4	-41.7
M	224 Valkyrie	88 gr. ELD® Match	81534	2675	2513	2356	2205	2060	1920	1398	1234	1085	950	829	720	-1.5	2.0	0	-8.3	-23.7	-47.4
SV	22-250 Rem	35 gr. NTX®	8334	4450	3736	3128	2598	2125	1706	1539	1085	761	524	351	226	-1.5	0.5	0	-4.1	-13.4	-30.6
V	22-250 Rem	50 gr. V-MAX®	8336	3800	3339	2925	2548	2201	1882	1603	1238	950	721	538	393	-1.5	0.8	0	-4.9	-15.2	-32.8
SV	22-250 Rem	50 gr. V-MAX®	83366	4000	3517	3086	2696	2337	2006	1776	1373	1057	807	606	447	-1.5	0.7	0	-4.3	-13.5	-29.1
V	22-250 Rem	55 gr. V-MAX®	8337	3680	3253	2868	2514	2186	1884	1654	1293	1004	772	583	433	-1.5	0.9	0	-5.1	-15.8	-33.9
V	220 Swift	55 gr. V-MAX®	8324	3680	3253	2868	2514	2186	1884	1654	1293	1004	772	583	433	-1.5	0.9	0	-5.1	-15.8	-33.9
SV	243 Win	58 gr. V-MAX®	8343	3925	3465	3052	2676	2330	2010	1984	1546	1200	922	699	520	-1.5	0.7	0	-4.4	-13.8	-29.6
SV	243 Win	75 gr. V-MAX®	83433	3580	3254	2953	2672	2407	2158	2134	1764	1452	1189	965	775	-1.5	0.9	0	-4.9	-14.7	-30.5
O	243 Win	80 gr. GMX®	80457	3200	2873	2570	2286	2021	1775	1819	1467	1173	929	725	560	-1.5	1.4	0	-6.7	-20.0	-41.9
CL	243 Win	87 gr. SST®	80466	2800	2574	2359	2155	1961	1778	1514	1280	1075	897	743	611	-1.5	1.9	0	-8.1	-23.8	-48.5
C	243 Win	87 gr. V-MAX®	80468	3240	2990	2754	2530	2317	2114	2028	1727	1465	1236	1037	863	-1.5	1.2	0	-5.8	-17.0	-34.8
PH	243 Win	90 gr. ELD-X®	80462	3150	2911	2685	2469	2264	2069	1983	1693	1440	1219	1024	855	-1.5	1.3	0	-6.1	-18.0	-36.6
SF	243 Win	95 gr. SST®	80463	3185	2908	2649	2404	2172	1953	2140	1784	1480	1219	995	804	-1.5	1.3	0	-6.3	-18.6	-38.3
W	243 Win	100 gr. InterLock® BTSP	8047	2960	2729	2509	2300	2101	1912	1945	1653	1398	1175	980	812	-1.5	1.6	0	-7.1	-20.9	-42.5
SF	6mm Rem	95 gr. SST®	81663	3235	2955	2693	2445	2211	1990	2207	1842	1530	1261	1031	835	-1.5	1.3	0	-6.1	-18.0	-37.0
V	6mm Creedmoor	87 gr. V-MAX®	81393	3210	2962	2727	2505	2292	2091	1990	1694	1437	1212	1015	844	-1.5	1.2	0	-5.9	-17.4	-35.5
SF	6mm Creedmoor	90 gr. GMX®	81394	3325	3082	2853	2635	2428	2230	2209	1898	1627	1388	1178	994	-1.5	1.1	0	-5.3	-15.7	-32.0
PH	6mm Creedmoor	103 gr. ELD-X®	81392	3050	2862	2687	2514	2348	2189	2127	1874	1651	1446	1261	1096	-1.5	1.4	0	-6.2	-17.9	-35.9
B	6mm Creedmoor	105 gr. BTHP	81396	2960	2782	2612	2447	2289	2136	2043	1805	1590	1396	1221	1064	-1.5	1.5	0	-6.6	-19.0	-38.1
M	6mm Creedmoor	108 gr. ELD® Match	81391	2960	2784	2615	2453	2296	2144	2101	1859	1640	1443	1264	1103	-1.5	1.5	0	-6.6	-19.0	-38.0
LEV	25-35 Win	110 gr. FTX®	8277	2425	2181	1952	1738	1543	1370	1436	1162	930	738	581	458	-0.8	3.3	0	-12.5	-36.5	-75.2
C	250 Savage	100 gr. InterLock® SP	8132	2800	2542	2299	2069	1853	1652	1741	1435	1173	950	762	606	-0.9	2.2	0	-8.9	-25.9	-53.1
SF	257 Roberts +P	117 gr. SST®	81353	2946	2707	2480	2265	2060	1866	2255	1903	1598	1332	1102	905	-1.5	1.6	0	-7.3	-21.4	-43.7
SF	25-06 Rem	90 gr. GMX®	81446	3350	3001	2679	2378	2098	1837	2243	1799	1434	1130	879	674	-1.5	1.2	0	-6.0	-18.3	-38.5
PH	25-06 Rem	110 gr. ELD-X®	8143	3140	2929	2728	2536	2351	2175	2408	2095	1817	1570	1350	1155	-1.5	1.3	0	-6.0	-17.3	-35.0
SF	25-06 Rem	117 gr. SST®	81453	3110	2862	2627	2405	2193	1992	2513	2127	1793	1502	1249	1031	-1.5	1.4	0	-6.4	-18.9	-38.6
W	25-06 Rem	117 gr. InterLock® BTSP	8144	2990	2749	2521	2304	2098	1902	2322	1963	1651	1379	1143	940	-1.5	1.6	0	-7.0	-20.7	-42.2
O	257 Wby Mag	90 gr. GMX®	81362																		

All data from a 24" Bbl, unless otherwise noted.

Ammo Description			Velocity (fps)							Energy (ft/lb)					Trajectory Tables (inches)						
CARTRIDGE	BULLET	ITEM #	MUZ	100 yd	200 yd	300 yd	400 yd	500 yd	MUZ	100 yd	200 yd	300 yd	400 yd	500 yd	MUZ	100 yd	200 yd	300 yd	400 yd	500 yd	
PH	257 Wby Mag	110 gr. ELD-X®	81364	3240	3024	2819	2623	2435	2255	2564	2233	1940	1680	1448	1241	-1.5	1.2	0	-5.5	-16.1	-32.6
B	6.5 Grendel	123 gr. ELD® Match	81528	2580	2409	2244	2086	1935	1791	1818	1585	1376	1189	1023	876	-1.5	2.3	0	-9.2	-26.4	-52.8
C	6.5 Grendel	123 gr. SST®	8152	2580	2410	2247	2090	1940	1796	1818	1586	1379	1193	1028	881	-1.5	2.3	0	-9.1	-26.3	-52.7
SF	6.5 x 55mm	140 gr. SST®	85507	2735	2563	2397	2237	2084	1937	2325	2041	1786	1556	1350	1166	-1.5	1.9	0	-8.0	-22.9	-45.9
SF	260 Rem	129 gr. SST®	8552	2930	2737	2552	2375	2204	2041	2459	2145	1865	1615	1391	1193	-1.5	1.6	0	-6.9	-20.0	-40.3
M	260 Rem	130 gr. ELD® Match	8553	2840	2674	2515	2361	2212	2069	2328	2064	1825	1609	1412	1235	-1.5	1.7	0	-7.2	-20.6	-41.2
V	6.5 Creedmoor	95 gr. V-MAX®	81481	3300	3023	2764	2520	2288	2068	2297	1928	1612	1339	1104	902	-1.5	1.2	0	-5.7	-16.9	-34.8
O	6.5 Creedmoor	120 gr. GMX®	81487	2925	2718	2520	2331	2150	1977	2280	1968	1693	1448	1232	1042	-1.5	1.6	0	-7.1	-20.6	-41.6
SF	6.5 Creedmoor	120 gr. GMX®	81490	3050	2850	2659	2476	2300	2132	2479	2164	1884	1634	1410	1211	-1.5	1.4	0	-6.3	-18.3	-36.9
M	6.5 Creedmoor	120 gr. ELD® Match	81491	2910	2719	2535	2359	2190	2028	2256	1969	1713	1483	1278	1096	-1.5	1.6	0	-7.0	-20.3	-40.8
SF	6.5 Creedmoor	129 gr. SST®	81496	2950	2756	2571	2394	2223	2059	2493	2176	1894	1641	1415	1214	-1.5	1.5	0	-6.8	-19.7	-39.7
AW	6.5 Creedmoor	129 gr. InterLock®	81489	2820	2615	2419	2232	2053	1882	2277	1959	1676	1427	1207	1015	-1.5	1.8	0	-7.7	-22.5	-45.5
M	6.5 Creedmoor	140 gr. ELD® Match	81500	2710	2564	2422	2285	2152	2023	2283	2043	1823	1622	1439	1273	-1.5	1.9	0	-7.8	-22.3	-44.4
AG	6.5 Creedmoor	140 gr. BTHP Match™	81482	2690	2536	2388	2245	2106	1972	2249	2000	1773	1566	1379	1209	-1.5	2.0	0	-8.1	-23.0	-45.8
PH	6.5 Creedmoor	143 gr. ELD-X®	81499	2700	2556	2417	2282	2151	2025	2315	2075	1855	1654	1470	1302	-1.5	1.9	0	-7.9	-22.4	-44.5
M	6.5 Creedmoor	147 gr. ELD® Match	81501	2695	2567	2443	2323	2206	2092	2370	2151	1948	1761	1587	1428	-1.5	1.9	0	-7.7	-21.9	-43.2
PH	6.5 PRC	143 gr. ELD-X®	81621	2960	2808	2661	2519	2381	2248	2782	2503	2248	2014	1800	1604	-1.5	1.5	0	-6.4	-18.2	-36.2
M	6.5 PRC	147 gr. ELD® Match	81620	2910	2775	2645	2518	2395	2275	2764	2514	2283	2069	1871	1689	-1.5	1.5	0	-6.5	-18.4	-36.5
C	264 Win Mag	140 gr. InterLock® SP	8154	2935	2734	2542	2358	2182	2013	2678	2324	2009	1729	1479	1259	-1.5	1.6	0	-7.0	-20.2	-40.8
C	6.8mm SPC	100 gr. GMX®	83481	2550	2276	2019	1781	1564	1373	1444	1150	905	704	543	419	-1.5	2.6	0	-11.2	-33.4	-69.9
B	6.8mm SPC	110 gr. V-MAX® (16" Bbl)	83464	2575	2343	2123	1916	1722	1544	1619	1341	1101	896	724	582	-2.4	2.0	0	-9.7	-29.0	-60.0
C	6.8mm SPC	120 gr. SST® (16" Bbl)	8347	2460	2250	2051	1863	1687	1524	1612	1349	1121	925	758	619	-2.4	2.3	0	-10.5	-31.1	-64.0
CL	270 Win	120 gr. SST®	80526	2675	2454	2244	2044	1855	1678	1907	1605	1342	1113	917	751	-1.5	2.1	0	-9.1	-26.5	-54.0
O	270 Win	130 gr. GMX®	80529	3050	2841	2642	2451	2268	2093	2685	2330	2014	1734	1485	1265	-1.5	1.4	0	-6.4	-18.6	-37.6
SF	270 Win	130 gr. GMX®	8052	3190	2975	2770	2575	2387	2208	2937	2554	2215	1913	1645	1407	-1.5	1.2	0	-5.7	-16.8	-33.9
SF	270 Win	130 gr. SST®	80543	3200	2984	2779	2583	2396	2216	2956	2570	2229	1926	1656	1417	-1.5	1.2	0	-5.7	-16.7	-33.7
AW	270 Win	130 gr. InterLock® SP	8053	3060	2852	2653	2463	2281	2107	2703	2347	2032	1752	1502	1281	-1.5	1.4	0	-6.4	-18.4	-37.2
SF	270 Win	140 gr. SST®	80563	3090	2894	2707	2528	2355	2189	2968	2604	2278	1986	1724	1490	-1.5	1.3	0	-6.1	-17.6	-35.5
AW	270 Win	140 gr. InterLock® SP	80534	2940	2747	2563	2386	2216	2053	2687	2346	2042	1770	1526	1310	-1.5	1.6	0	-6.8	-19.8	-39.9
PH	270 Win	145 gr. ELD-X®	80536	2970	2796	2627	2465	2308	2157	2840	2516	2222	1955	1714	1497	-1.5	1.5	0	-6.5	-18.8	-37.6
O	270 WSM	130 gr. GMX®	80557	3150	2937	2734	2540	2354	2176	2864	2489	2157	1862	1599	1366	-1.5	1.3	0	-5.9	-17.3	-34.9
PH	270 WSM	145 gr. ELD-X®	80558	3100	2918	2744	2576	2414	2258	3094	2741	2423	2136	1876	1641	-1.5	1.3	0	-5.9	-17.1	-34.2
C	275 Rigby	140 gr. InterLock® SP	8070	2680	2456	2242	2040	1848	1670	2217	1861	1552	1284	1054	860	-1.5	2.2	0	-9.1	-26.5	-54.2
CL	7mm-08 Rem	120 gr. SST®	80572	2675	2435	2207	1992	1790	1604	1907	1579	1298	1057	854	685	-1.5	2.2	0	-9.4	-27.5	-56.6
SF	7mm-08 Rem	139 gr. GMX®	80576	2910	2719	2535	2359	2190	2028	2613	2281	1984	1718	1481	1270	-1.5	1.6	0	-7.0	-20.3	-40.8
SF	7mm-08 Rem	139 gr. SST®	80573	2950	2757	2572	2395	2224	2061	2686	2346	2042	1770	1527	1311	-1.5	1.5	0	-6.8	-19.7	-39.6
AW	7mm-08 Rem	139 gr. InterLock® SP	8057	2840	2608	2387	2177	1978	1790	2489	2098	1758	1463	1207	989	-1.5	1.8	0	-7.9	-23.2	-47.5
PH	7mm-08 Rem	150 gr. ELD-X®	85578	2770	2613	2461	2315	2173	2037	2555	2274	2018	1784	1573	1381	-1.5	1.8	0	-7.5	-21.6	-43.0
PH	280 Rem	150 gr. ELD-X®	81587	2925	2763	2607	2455	2309	2167	2849	2543	2263	2007	1775	1564	-1.5	1.5	0	-6.7	-19.1	-38.0
PH	280 Ackley Imp	162 gr. ELD-X®	85586	2850	2704	2562	2424	2291	2162	2921	2629	2360	2114	1888	1681	-1.5	1.6	0	-6.9	-19.8	-39.3
AW	7mm Rem Mag	139 gr. InterLock® SP	80591	3150	2933	2728	2531	2343	2162	3062	2656	2296	1977	1694	1443	-1.5	1.3	0	-5.9	-17.3	-35.1
SF	7mm Rem Mag	139 gr. SST®	80593	3240	3033	2837	2649	2469	2295	3240	2840	2484	2166	1881	1626	-1.5	1.2	0	-5.5	-15.9	-32.0

All data from a 24" Bbl, unless otherwise noted.

Ammo Description			Velocity (fps)							Energy (ft/lb)					Trajectory Tables (inches)						
CARTRIDGE	BULLET	ITEM #	MUZ	100 yd	200 yd	300 yd	400 yd	500 yd	MUZ	100 yd	200 yd	300 yd	400 yd	500 yd	MUZ	100 yd	200 yd	300 yd	400 yd	500 yd	
O	7mm Rem Mag	150 gr. GMX®	80611	3000	2796	2601	2414	2235	2063	2997	2603	2253	1941	1663	1418	-1.5	1.5	0	-6.6	-19.2	-38.8
AW	7mm Rem Mag	154 gr. InterLock® SP	80590	3035	2815	2605	2405	2214	2031	3150	2709	2321	1978	1676	1411	-1.5	1.5	0	-6.6	-19.2	-38.9
SF	7mm Rem Mag	154 gr. SST®	8061	3100	2915	2737	2567	2403	2244	3286	2905	2562	2253	1974	1722	-1.5	1.3	0	-5.9	-17.2	-34.4
SF	7mm Rem Mag	162 gr. SST®	80633	3030	2856	2689	2527	2372	2222	3302	2933	2600	2298	2023	1775	-1.5	1.4	0	-6.2	-17.8	-35.7
PH	7mm Rem Mag	162 gr. ELD-X®	80636	2975	2827	2682	2542	2406	2274	3183	2874	2588	2324	2082	1860	-1.5	1.4	0	-6.3	-17.9	-35.6
O	7mm WSM	150 gr. GMX®	80551	3050	2843	2646	2458	2277	2103	3098	3692	2332	2012	1726	1473	-1.5	1.4	0	-6.4	-18.5	-37.4
PH	7mm WSM	162 gr. ELD-X®	80552	3000	2849	2702	2560	2423	2290	3237	2918	2626	2358	2112	1886	-1.5	1.4	0	-6.2	-17.6	-35.0
LEV	7-30 Waters	120 gr. FTX®	81569																		
PH	28 Nosler	162 gr. ELD-X®	8069	3175	3017	2866	2719	2578	2440	3626	3275	2954	2660	2390	2142	-1.5	1.2	0	-5.4	-15.5	-30.9
PH	7mm STW	162 gr. ELD-X®	80851	3050	2897	2749	2606	2468	2333	3346	3018	2718	2443	2190	1958	-1.5	1.3	0	-5.6	-17.0	-33.8
CD	30 Carbine	110 gr. FTX® (20" Bbl)	81030	2000	1601	1279	1067	—	—	977	626	399	278	—	—	-0.9	0	-12.9	-47.2	—	—
C	300 Blackout	110 gr. GMX® (16" Bbl)	80879	2285	2023	1781	1561	—	—	1275	1000	775	595	—	—	-1.5	3.5	0	-14.5	—	—
B	300 Blackout	110 gr. V-MAX® (16" Bbl)	80873	2375	2094	1834	1597	—	—	1378	1071	821	623	—	—	-1.5	3.2	0	-13.7	—	—
AG	300 Blackout	125 gr. HP Match™ (16" Bbl)	80897	2175	1932	1708	1505	—	—	1313	1036	810	609	—	—	-1.5	4.0	0	-15.9	—	—
C	300 Blackout	135 gr. FTX® (16" Bbl)	80881	2085	1811	1564	1350	—	—	1303	983	733	546	—	—	-1.5	4.6	0	-18.9	—	—
SUB	300 Blackout	190 gr. SUB-X™ (16" Bbl)	80877	1050	998	955	918	—	—	465	420	384	355	—	—	-1.5	0	-33.4	-104.6	—	—
B	300 Blackout	208 gr. A-MAX® (16" Bbl)	80891	1020	987	959	—	—	—	480	450	424	—	—	—	-1.5	0	-33.5	—	—	—
LEV	30-30 Win	140 gr. MonoFlex®	82731	2465	2165	1887	1635	—	—	1889	1457	1107	831	—	—	-1.5	3.0	0	-12.8	—	—
AW	30-30 Win	150 gr. RN	80801	2390	1959	1581	1276	—	—	1902	1278	832	542	—	—	-1.5	0	-7.7	-29.6	—	—
LEV	30-30 Win	160 gr. FTX®	82730	2400	2151	1917	1700	—	—	2046	1643	1305	1027	—	—	-1.5	3.0	0	-12.5	—	—
SUB	30-30 Win	175 gr. SUB-X™	80809																		
SF	300 Savage	150 gr. SST®	82221	2740	2499	2272	2056	1852	1663	2500	2081	1718	1407	1143	921	-1.5	2.1	0	-8.8	-25.8	-53.1
LEV	307 Win	160 gr. FTX®	8273	2650	2386	2137	1904	1688	1492	2494	2022	1622	1287	1012	791	-1.5	2.3	0	-10	-29.6	-61.4
LEV	308 Marlin Express	160 gr. FTX®	82733	2660	2438	2227	2027	1838	1661	2514	2112	1762	1459	1200	980	-1.5	2.2	0	-9.2	-26.9	-54.9
CL	308 Win	125 gr. SST®	80866	2675	2389	2121	1871	1642	1437	1986	1584	1248	971	748	573	-1.5	2.3	0	-10.1	-30.1	-63.2
SF	308 Win	150 gr. SST®	80933	3000	2772	2556	2350	2153	1966	2997	2559	2176	1839	1543	1287	-1.5	1.5	0	-6.8	-20.0	-40.7
AW	308 Win	150 gr. InterLock® SP	8090	2820	2561	2316	2085	1868	1667	2649	2184	1787	1448	1162	925	-1.5	1.9	0	-8.4	-24.9	-51.3
C	308 Win	150 gr. SST®	8093	2820	2601	2393	2194	2005	1826	2649	2253	1907	1603	1338	1110	-1.5	1.8	0	-7.9	-23.1	-46.9
CD	308 Win	155 gr. FTX®	80920	2785	2499	2231	1980	—	—	2669	2150	1713	1349	—	—	-1.5	0	-4.1	-15.2	—	—
B	308 Win	155 gr. A-MAX®	80927	2850	2639	2438	2245	2062	1887	2795	2397	2045	1735	1463	1225	-1.5	1.8	0	-7.6	-22.1	-44.9
AG	308 Win	155 gr. BTHP Match™	80967	2700	2482	2274	2076	1888	1712	2509	2119	1779	1483	1227	1009	-1.5	2.1	0	-8.8	-25.7	-52.4
AW	308 Win	165 gr. InterLock® SP	80904	2700	2496	2302	2116	1939	1772	2671	2283	1941	1640	1377	1150	-1.5	2.1	0	-8.6	-25.0	-50.7
O	308 Win	165 gr. GMX®	80986	2610	2430	2258	2093	1935	1785	2723	2361	2038	1751	1496	1273	-1.5	2.2	0	-9.0	-26.0	-52.3
SF	308 Win	165 gr. SST®	80983	2840	2636	2440	2253	2074	1904	2955	2545	2182	1860	1577	1328	-1.5	1.8	0	-7.6	-22.1	-44.6
SF	308 Win	165 gr. GMX®	8099	2750	2550	2358	2174	1999	1833	2771	2381	2037	1732	1464	1231	-1.5	1.9	0	-8.2	-23.8	-48.1
M	308 Win	168 gr. BTHP	8097	2700	2503	2315	2134	1962	1799	2719	2337	1998	1699	1436	1207	-1.5	2.0	0	-8.5	-24.7	-50.0
M	308 Win	168 gr. ELD® Match	80966	2700	2530	2366	2209	2057	1912	2719	2388	2089	1820	1579	1364	-1.5	2.0	0	-8.2	-23.5	-47.1
SM	308 Win	168 gr. ELD® Match	80963	2840	2665	2496	2334	2177	2027	3009	2649	2324	2032	1769	1533	-1.5	1.7	0	-7.3	-21.0	-42.0
B	308 Win	168 gr. A-MAX®	80971	2700	2513	2333	2161	1996	1839	2719	2355	2030	1742	1486	1261	-1.5	2.0	0	-8.4	-24.3	-48.9
M	308 Win	178 gr. BTHP	8105	2600	2436	2278	2125	1979	1839	2672	2345	2050	1785	1548	1337	-1.5	2.2	0	-8.9	-25.5	-51.0
PH	308 Win	178 gr. ELD-X®	80994	2600	2443	2291	2145	2004	1868	2671	2358	2074	1818	1587	1379	-1.5	2.2	0	-8.8	-25.2	-50.2
C	30-40 Krag	180 gr. InterLock® SP	81202	2430	2234	2047	1869	1703	1548	2360	1994	1674	1397	1159	958	-1.5	2.8	0	-11.0	-32.1	-65.2

All data from a 24" Bbl, unless otherwise noted.

Ammo Description			Velocity (fps)							Energy (ft/lb)					Trajectory Tables (inches)						
CARTRIDGE	BULLET	ITEM #	MUZ	100 yd	200 yd	300 yd	400 yd	500 yd	MUZ	100 yd	200 yd	300 yd	400 yd	500 yd	MUZ	100 yd	200 yd	300 yd	400 yd	500 yd	
SF	30 TC	150 gr. SST®	81004	3000	2772	2556	2350	2153	1966	2997	2559	2176	1839	1543	1287	-1.5	1.5	0	-6.8	-20.0	-40.7
CL	30-06 Springfield	125 gr. SST®	81066	2700	2412	2143	1891	1660	1454	2023	1615	1274	993	765	586	-1.5	2.3	0	-9.9	-29.5	-61.9
SF	30-06 Springfield	150 gr. SST®	81093	3080	2848	2628	2418	2218	2028	3159	2701	2300	1948	1639	1370	-1.5	1.4	0	-6.4	-18.8	-38.3
AW	30-06 Springfield	150 gr. InterLock® SP	8108	2910	2637	2381	2139	1911	1700	2820	2317	1888	1523	1216	963	-1.5	1.8	0	-7.9	-23.5	-48.6
SF	30-06 Springfield	165 gr. SST®	81153	2960	2750	2550	2358	2175	2000	3210	2770	2382	2037	1733	1465	-1.5	1.6	0	-6.9	-20.1	-40.6
SF	30-06 Springfield	165 gr. GMX®	8116	2940	2731	2532	2341	2158	1984	3167	2732	2348	2007	1706	1442	-1.5	1.6	0	-7.0	-20.4	-41.3
VM	30-06 Springfield	168 gr. ELD® Match	81171	2710	2540	2376	2218	2066	1920	2739	2406	2105	1835	1592	1375	-1.5	2.0	0	-8.1	-23.3	-46.7
PH	30-06 Springfield	178 gr. ELD-X®	81174	2750	2588	2431	2280	2134	1993	2988	2646	2335	2054	1799	1570	-1.5	1.8	0	-7.7	-22.2	-44.3
O	30-06 Springfield	180 gr. GMX®	81164																		
AW	30-06 Springfield	180 gr. InterLock® SP	81084	2700	2492	2293	2103	1923	1753	2714	2481	2101	1768	1478	1228	-1.5	2.1	0	-8.7	-25.2	-51.2
SF	30-06 Springfield	180 gr. SST®	81183	2820	2630	2448	2274	2106	1946	3178	2765	2396	2066	1772	1513	-1.5	1.8	0	-7.6	-21.9	-44.1
C	300 H&H Mag	180 gr. InterBond®	8210	2870	2678	2494	2318	2148	1986	3292	2866	2486	2147	1844	1576	-1.5	1.7	0	-7.3	-21.0	-42.3
PH	300 RSAUM	178 gr. ELD-X®	82144																		
SF	300 RCM	150 gr. SST®	82231	3310	3065	2834	2615	2406	2207	3649	3129	2675	2277	1928	1622	-1.5	1.1	0	-5.5	-16.0	-32.6
PH	300 RCM	178 gr. ELD-X®	82224	2900	2733	2571	2415	2264	2119	3323	2952	2613	2305	2026	1774	-1.5	1.6	0	-6.8	-19.7	-39.3
AW	300 WSM	165 gr. InterLock®	82204	3130	2906	2693	2490	2296	2110	3589	3093	2657	2271	1931	1631	-1.5	1.3	0	-6.1	-17.9	-36.2
O	300 WSM	180 gr. GMX®	82203	2900	2709	2526	2350	2181	2019	3361	2932	2549	2206	1900	1628	-1.5	1.6	0	-7.1	-20.5	-41.5
PH	300 WSM	200 gr. ELD-X®	82208	2820	2667	2519	2375	2237	2103	3531	3158	2817	2506	2222	1963	-1.5	1.7	0	-7.2	-20.6	-40.9
AW	300 Win Mag	150 gr. InterLock® SP	8204	3275	2988	2719	2466	2227	2001	3572	2973	2463	2026	1651	1333	-1.5	1.2	0	-5.9	-17.6	-36.3
SF	300 Win Mag	165 gr. GMX®	82026	3260	3035	2822	2618	2424	2237	3893	3374	2917	2511	2152	1834	-1.5	1.2	0	-5.5	-16.1	-32.6
M	300 Win Mag	178 gr. ELD® Match	82043	2960	2788	2622	2462	2308	2159	3463	3071	2717	2396	2106	1843	-1.5	1.5	0	-6.5	-18.8	-37.7
PH	300 Win Mag	178 gr. ELD-X®	82041																		
O	300 Win Mag	180 gr. GMX®	82197	2960	2766	2581	2403	2231	2067	3502	3058	2662	2307	1990	1708	-1.5	1.5	0	-6.8	-19.6	-39.3
AW	300 Win Mag	180 gr. InterLock® SP	82044	2960	2739	2530	2329	2138	1956	3502	2999	2557	2168	1826	1529	-1.5	1.6	0	-7.0	-20.4	-41.5
SF	300 Win Mag	180 gr. SST®	82193	3130	2926	2732	2546	2368	2196	3915	3422	2983	2591	2240	1928	-1.5	1.3	0	-5.9	-17.2	-34.8
M	300 Win Mag	195 gr. ELD® Match	82180	2930	2769	2615	2465	2321	2181	3717	3321	2960	2631	2332	2059	-1.5	1.5	0	-6.6	-18.9	-37.7
PH	300 Win Mag	200 gr. ELD-X®	82002	2860	2707	2558	2414	2274	2140	3632	3253	2905	2587	2297	2033	-1.5	1.6	0	-6.9	-19.9	-39.5
O	300 Wby Mag	180 gr. GMX®	82212	3100	2900	2709	2526	2350	2181	3841	3360	2932	2549	2206	1900	-1.5	1.3	0	-6.4	-17.6	-35.4
PH	300 Wby Mag	200 gr. ELD-X®	82213	2960	2804	2652	2505	2363	2225	3890	3491	3123	2786	2479	2198	-1.5	1.5	0	-6.4	-18.4	-36.5
PH	300 PRC	212 gr. ELD-X®	82166	2860	2723	2589	2460	2334	2212	3850	3489	3156	2849	2565	2304	-1.5	1.6	0	-6.8	-19.3	-38.3
M	300 PRC	225 gr. ELD® Match	82162	2810	2692	2577	2465	2356	2250	3945	3620	3318	3036	2773	2528	-1.5	1.7	0	-6.9	-19.5	-39.4
M	300 Norma Mag	225 gr. ELD® Match	82176	2850	2731	2615	2502	2392	2285	4058	3726	3417	3128	2859	2608	-1.5	1.6	0	-6.7	-18.9	-37.2
O	300 Rem Ultra Mag	180 gr. GMX®	8208	3200	2995	2800	2613	2434	2261	4093	3585	3133	2729	2367	2044	-1.5	1.2	0	-5.6	-16.3	-33.0
PH	300 Rem Ultra Mag	220 gr. ELD-X®	8209	2910	2766	2627	2492	2361	2234	4136	3738	3371	3034	2723	2438	-1.5	1.5	0	-6.5	-18.7	-37.1
PH	30-378 Wby Mag	220 gr. ELD-X®	82214	3025	2877	2735	2597	2463	2332	4470	4044	3653	3293	2962	2657	-1.5	1.4	0	-6.0	-17.2	-34.1
B	7.62 x 39	123 gr. SST® (20" Bbl)	80784	2350	2040	1756	1503	1290	1129	1508	1136	842	617	454	348	-1.5	3.5	0	-14.8	-45.2	-96.5
AG	7.62 x 39	123 gr. HP Match™ (20" Bbl)	80786																		
C	303 British	150 gr. InterLock® SP	8225	2685	2441	2211	1993	1789	1601	2401	1985	1628	1323	1066	854	-1.5	2.2	0	-9.3	-27.4	-56.4
LEV	32 Win Special	165 gr. FTX®	82732	2410	2144	1897	1669	—	—	2128	1685	1318	1020	—	—	-0.9	3.4	0	-13.1	—	—
VM	8 x 57	196 gr. BTHP	82298	2500	2338	2182	2032	1888	1751	2720	2379	2072	1797	1552	1335	-1.5	2.4	0	-9.8	-27.9	-55.9
LEV	338 Marlin Express	200 gr. FTX®	82240	2565	2365	2174	1992	1820	1659	2922	2484	2099	1763	1471	1221	-1.5	2.4	0	-9.7	-28.3	-57.3
SF	338 RCM	225 gr. SST®	82236	2750	2575	2408	2246	2091	1942	3778	3314	2896	2521	2184	1884	-1.5	1.9	0	-7.9	-22.7	-45.5

All data from a 24" Bbl, unless otherwise noted.

Ammo Description			Velocity (fps)							Energy (ft/lb)						Trajectory Tables (inches)					
CARTRIDGE	BULLET	ITEM #	MUZ	100 yd	200 yd	300 yd	400 yd	500 yd	MUZ	100 yd	200 yd	300 yd	400 yd	500 yd	MUZ	100 yd	200 yd	300 yd	400 yd	500 yd	
SF	338 Win Mag	200 gr. SST®	82223	3030	2820	2620	2429	2246	2071	4077	3532	3049	2621	2240	1904	-1.5	1.4	0	-6.5	-18.9	-38.3
SF	338 Win Mag	225 gr. SST®	82233	2840	2662	2491	2326	2168	2016	4029	3540	3100	2704	2348	2030	-1.5	1.7	0	-7.3	-21.1	-42.2
O	338 Win Mag	225 gr. GMX®	82339	2800	2607	2422	2245	2075	1913	3917	3395	2931	2518	2151	1828	-1.5	1.8	0	-7.8	-22.4	-45.2
PH	338 Win Mag	230 gr. ELD-X®	82222	2810	2662	2519	2831	2246	2116	4032	3620	3241	2894	2576	2287	-1.5	1.7	0	-7.2	-20.5	-40.7
M	338 Lapua Mag	250 gr. BTHP	8230	2860	2722	2587	2457	2331	2208	4540	4111	3716	3351	3015	2706	-1.5	1.6	0	-6.8	-19.3	-38.3
PH	338 Lapua Mag	270 gr. ELD-X®	82313	2800	2680	2562	2447	2336	2227	4699	4304	3935	3590	3270	2973	-1.5	1.7	0	-7.0	-19.7	-39.9
M	338 Lapua Mag	285 gr. ELD® Match	82300	2745	2636	2530	2426	2324	2225	4768	4397	4049	3723	3418	3133	-1.5	1.8	0	-7.2	-20.3	-39.8
LEV	348 Win	200 gr. FTX®	82738	2560	2294	2044	1811	1597	1407	2910	2336	1855	1456	1133	879	-1.5	2.6	0	-10.8	-32.6	-67.9
C	350 Legend	165 gr. FTX®	81197	2200	1890	1612	1371	—	—	1773	1309	952	689	—	—	-1.5	4.2	0	-17.6	—	—
W	350 Legend	170 gr. InterLock® SP	81196	2200	1843	1529	1271	—	—	1827	1281	882	609	—	—	-1.5	4.5	0	-19.4	—	—
LEV	35 Rem	200 gr. FTX®	82735	2225	1963	1722	1505	—	—	2198	1711	1317	1006	—	—	-1.5	3.8	0	-15.6	—	—
C	358 Win	200 gr. InterLock® SP	91318	2475	2180	1906	1655	1434	1248	2720	2110	1612	1217	913	692	-1.5	2.9	0	-12.6	-37.9	-80.3
SF	35 Whelen	200 gr. InterLock® SP	81193	2910	2585	2283	2001	1742	1509	3760	2968	2314	1778	1347	1012	-1.5	1.9	0	-8.6	-25.9	-54.8
DG	9.3 x 74R	286 gr. InterLock® SP-RP	82304	2360	2155	1961	1778	1608	1453	3537	2949	2442	2008	1642	1341	-1.5	0	-6.0	-21.1	-47.2	-86.8
DG	9.3 x 62mm	286 gr. InterLock® SP-RP	82303	2360	2155	1961	1778	1608	1453	3537	2949	2442	2008	1642	1341	-1.5	0	-6.0	-21.1	-47.2	-86.8
DG	376 Steyr	225 gr. InterLock® SP-RP	8234	2600	2332	2079	1844	1627	1434	3377	2716	2160	1698	1323	1027	-1.5	0	-4.9	-17.9	-41.2	-77.7
DG	376 Steyr	270 gr. InterLock® SP-RP	8237	2600	2372	2156	1951	1759	1582	4052	3373	2787	2283	1855	1500	-1.5	0	-4.7	-16.9	-38.3	-70.9
O	375 H&H Mag	250 gr. GMX®	82331	2700	2494	2297	2110	1931	1762	4047	3453	2930	2471	2070	1724	-1.5	2.1	0	-8.7	-25.1	-51.0
DG	375 H&H Mag	270 gr. InterLock® SP-RP SPF	8508	2800	2562	2336	2122	1919	1729	4699	3935	3272	2699	2208	1793	-1.5	0	-3.8	-14.0	-32.0	-59.4
DG	375 H&H Mag	300 gr. DGS®	82322	2530	2223	1938	1678	1448	1256	4263	3292	2503	1875	1396	1050	-1.5	0	-5.6	-20.5	-47.8	-91.9
DG	375 H&H Mag	300 gr. DGX® Bonded	82334	2530	2223	1938	1678	1448	1256	4263	3292	2503	1875	1396	1050	-1.5	0	-5.6	-20.5	-47.8	-91.9
O	375 Ruger	250 gr. GMX®	82337	2800	2589	2389	2197	2014	1840	4352	3722	3167	2679	2251	1880	-1.5	1.9	0	-7.9	-23.1	-46.9
DG	375 Ruger	270 gr. InterLock® SP-RP	8231	2840	2600	2372	2156	1951	1759	4835	4052	3373	2786	2283	1855	-1.5	0	-3.7	-13.5	-30.9	-57.4
DG	375 Ruger	300 gr. DGX® Bonded	82336	2660	2344	2050	1780	1536	1328	4713	3660	2800	2110	1572	1174	-1.5	0	-4.9	-18.1	-42.3	-81.4
DG	375 Ruger	300 gr. DGS®	8232	2660	2344	2050	1780	1536	1328	4713	3660	2800	2110	1572	1174	-1.5	0	-4.9	-18.1	-42.3	-81.4
DG	450-400 Nitro Express 3"	400 gr. DGX® Bonded	82432	2050	1820	1609	1420	—	—	3732	2940	2298	1791	—	—	-0.9	0	-9.7	-32.8	—	—
DG	450-400 Nitro Express 3"	400 gr. DGS®	8242	2050	1820	1609	1420	—	—	3732	2940	2298	1791	—	—	-0.9	0	-9.7	-32.8	—	—
C	405 Win	300 gr. InterLock® SP	8241	2200	1890	1612	1371	—	—	3224	2380	1730	1252	—	—	-1.5	0	-8.3	-30.2	—	—
DG	416 Ruger	400 gr. DGX® Bonded	82667	2400	2142	1901	1678	—	—	5115	4075	3208	2500	—	—	-1.5	0	-6.1	-21.9	—	—
DG	416 Ruger	400 gr. DGS®	82666	2400	2142	1901	1678	—	—	5115	4075	3208	2500	—	—	-1.5	0	-6.1	-21.9	—	—
DG	416 Rem Mag	400 gr. DGX® Bonded	82672	2400	2142	1901	1678	—	—	5115	4075	3208	2500	—	—	-1.5	0	-6.1	-21.9	—	—
DG	416 Rem Mag	400 gr. DGS®	82674	2400	2142	1901	1678	—	—	5115	4075	3208	2500	—	—	-1.5	0	-6.1	-21.9	—	—
DG	416 Rigby	400 gr. DGX® Bonded	82661	2415	2156	1915	1691	—	—	5180	4130	3256	2540	—	—	-1.5	0	-6.0	-21.6	—	—
DG	416 Rigby	400 gr. DGS®	8265	2415	2156	1915	1691	—	—	5180	4130	3256	2540	—	—	-1.5	0	-6.0	-21.6	—	—
DG	500-416 Nitro Express	400 gr. DGX® Bonded	82683	2300	2048	1815	1598	—	—	4698	3725	2927	2269	—	—	-1.5	0	-6.4	-24.3	—	—
DG	500-416 Nitro Express	400 gr. DGS®	82682	2300	2048	1815	1598	—	—	4698	3725	2927	2269	—	—	-1.5	0	-6.4	-24.3	—	—
DG	404 Jeffery	400 gr. DGX® Bonded	82381	2300	2053	1823	1611	—	—	4698	3743	2950	2306	—	—	-1.5	0	-6.8	-24.1	—	—
DG	404 Jeffery	400 gr. DGS®	8239	2300	2053	1823	1611	—	—	4698	3743	2950	2306	—	—	-1.5	0	-6.8	-24.1	—	—
SF	444 Marlin	265 gr. InterLock® FP	82453	2400	1974	1601	1295	—	—	3389	2294	1508	987	—	—	-1.5	3.8	0	-17.5	—	—
LEV	444 Marlin	265 gr. FTX®	82744	2325	1971	1654	1381	—	—	3181	2286	1609	1123	—	—	-1.5	3.8	0	-16.6	—	—
W	450 Bushmaster	245 gr. InterLock®	82242	2200	1742	1364	1103	—	—	2633	1651	1012	662	—	—	-1.5	5.1	0	-24.0	—	—
C	450 Bushmaster	250 gr. FTX® (20" Bbl)	82244	2200	1835	1515	1255	—	—	2687	1868	1274	874	—	—	-2.4	4.1	0	-19.3	—	—

All data from a 24" Bbl, unless otherwise noted.

Ammo Description			Velocity (fps)							Energy (ft/lb)						Trajectory Tables (inches)					
CARTRIDGE	BULLET	ITEM #	MUZ	100 yd	200 yd	300 yd	400 yd	500 yd	MUZ	100 yd	200 yd	300 yd	400 yd	500 yd	MUZ	100 yd	200 yd	300 yd	400 yd	500 yd	
B	450 Bushmaster	250 gr. FTX® (20" Bbl)	82246	2200	1835	1515	1255	—	—	2687	1868	1274	874	—	—	-2.4	4.1	0	-19.3	—	—
SUB	450 Bushmaster	395 gr. SUB-X™ (20" Bbl)	82247																		
LEV	45-70 Govt	250 gr. MonoFlex®	82741	2025	1616	1285	1068	—	—	2276	1449	917	634	—	—	-1.5	6.1	0	-27.2	—	—
LEV	45-70 Govt	325 gr. FTX®	82747	2000	1685	1413	1197	—	—	2886	2049	1441	1035	—	—	-1.5	5.5	0	-23.0	—	—
SUB	45-70 Govt	410 gr. SUB-X™	82742																		
LEV	450 Marlin	325 gr. FTX®	82750	2225	1887	1587	1332	—	—	3572	2570	1816	1280	—	—	-1.5	4.2	0	-18.1	—	—
DG	450 Rigby	480 gr. DGX® Bonded	82668	2400	2112	1846	1603	—	—	6138	4755	3630	2739	—	—	-1.5	0	-6.3	-23.0	—	—
DG	450 Rigby	480 gr. DGS®	82662	2400	2112	1846	1603	—	—	6138	4755	3630	2739	—	—	-1.5	0	-6.3	-23.0	—	—
DG	450 Nitro Express 3¼"	480 gr. DGX® Bonded	8257	2150	1881	1635	1418	—	—	4927	3769	2850	2144	—	—	-1.5	0	-8.4	-29.9	—	—
DG	450 Nitro Express 3¼"	480 gr. DGS®	8256	2150	1881	1635	1418	—	—	4927	3769	2850	2144	—	—	-1.5	0	-8.4	-29.9	—	—
DG	458 Win Mag	500 gr. DGX® Bonded SPF	85834	2140	1880	1643	1432	—	—	5084	3924	2996	2276	—	—	-1.5	0	-8.4	-29.8	—	—
DG	458 Win Mag	500 gr. DGS® SPF	8585	2140	1880	1643	1432	—	—	5084	3924	2996	2276	—	—	-1.5	0	-8.4	-29.8	—	—
DG	458 Lott	500 gr. DGX® Bonded	82614	2300	2029	1778	1551	—	—	5873	4569	3509	2671	—	—	-1.5	0	-7.0	-25.1	—	—
DG	458 Lott	500 gr. DGS®	8262	2300	2029	1778	1551	—	—	5873	4569	3509	2671	—	—	-1.5	0	-7.0	-25.1	—	—
DG	470 Nitro Express	500 gr. DGX® Bonded	82631	2150	1885	1643	1429	—	—	5132	3945	2998	2267	—	—	-0.9	0	-8.9	-30.8	—	—
DG	470 Nitro Express	500 gr. DGS®	8264	2150	1885	1643	1429	—	—	5132	3945	2998	2267	—	—	-0.9	0	-8.9	-30.8	—	—
DG	500 Nitro Express 3"	570 gr. DGX® Bonded	82689	2120	1862	1626	1417	—	—	5688	4386	3346	2542	—	—	-0.9	0	-9.2	-31.6	—	—
DG	500 Nitro Express 3"	570 gr. DGS®	8269	2120	1862	1626	1417	—	—	5688	4386	3346	2542	—	—	-0.9	0	-9.2	-31.6	—	—
M	50 BMG	750 gr. A-MAX® (36" Bbl)	8270	2815	2727	2641	2557	2474	2393	13196	12386	11619	10889	10196	9538	-1.8	1.4	0	-6.4	-18.2	-35.6

All data from a 24" Bbl, unless otherwise noted.

Frontier® Cartridge Ballistics

Ammo Description			Velocity (fps)							Energy (ft/lb)						Trajectory Tables (inches)					
CARTRIDGE	BULLET	ITEM #	MUZ	100 yd	200 yd	300 yd	400 yd	500 yd	MUZ	100 yd	200 yd	300 yd	400 yd	500 yd	MUZ	100 yd	200 yd	300 yd	400 yd	500 yd	
223 Rem	55 gr. FMJ (24" Bbl)	FR100	3240	2837	2468	2128	1817	1540	1282	983	744	553	403	290	-1.5	1.4	0	-7.2	-22.1	-47.7	
223 Rem	55 gr. Spire Point (24" Bbl)	FR120	3240	2824	2444	2095	1777	1497	1282	974	730	536	386	274	-1.5	1.5	0	-7.3	-22.6	-49.1	
223 Rem	55 gr. Hollow Point Match (24" Bbl)	FR140	3240	2853	2499	2171	1869	1597	1282	994	763	576	427	311	-1.5	1.4	0	-7.0	-21.5	-46.0	
223 Rem	68 gr. BTHP Match (24" Bbl)	FR160	2960	2697	2449	2215	1993	1786	1323	1098	906	741	600	482	-1.5	1.7	0	-7.5	-22.0	-45.4	
6.5 Grendel	123 gr. FMJ	FR700																			
5.56 NATO	55 gr. FMJ (M193) (20" Bbl)	FR200	3240	2837	2468	2128	1817	1540	1282	983	744	553	403	290	-1.5	1.4	0	-7.2	-22.1	-47.7	
5.56 NATO	55 gr. Hollow Point Match (20" Bbl)	FR240	3240	2853	2499	2171	1869	1597	1282	994	763	576	427	311	-1.5	1.4	0	-7.0	-21.5	-46.0	
5.56 NATO	62 gr. FMJ (20" Bbl)	FR260	3060	2715	2395	2097	1822	1574	1289	1015	790	606	457	341	-1.5	1.6	0	-7.7	-23.4	-49.6	
5.56 NATO	62 gr. Spire Point (20" Bbl)	FR280	3060	2702	2372	2065	1783	1531	1289	1005	774	587	438	323	-1.5	1.7	0	-7.9	-23.9	-51.1	
5.56 NATO	62 gr. BTHP Match (20" Bbl)	FR300	3060	2763	2485	2223	1978	1750	1289	1051	850	680	538	421	-1.5	1.5	0	-7.2	-21.5	-44.7	
5.56 NATO	68 gr. BTHP Match (20" Bbl)	FR310	2960	2697	2449	2215	1993	1786	1323	1098	906	741	600	482	-1.5	1.7	0	-7.5	-22.0	-45.4	
5.56 NATO	75 gr. BTHP Match (20" Bbl)	FR320	2860	2603	2360	2130	1914	1712	1362	1128	928	756	610	488	-1.5	1.8	0	-8.1	-23.9	-49.2	
300 Blackout	125 gr. FMJ (16" Bbl)	FR400	2175	1867	1591	1354	1169	1044	1313	968	703	509	379	302	-1.5	4.3	0	-18.1	-55.3	-118	

Muzzleloader Projectile Ballistics

Muzzleloader Ammo Description			Velocity (fps)						Energy (ft/lb)						Trajectory Tables (inches)					
DESCRIPTION	BULLET WT.	ITEM #	MUZ	50 yd	100 yd	150 yd	200 yd	250 yd	MUZ	50 yd	100 yd	150 yd	200 yd	250 yd	MUZ	50 yd	100 yd	150 yd	200 yd	250 yd
45 Cal. SST®-ML™ Low Drag Sabot	200 gr.	67132	2325	2171	2022	1880	1744	1616	2400	2092	1815	1569	1351	1160	-1.5	2.0	3.0	2.0	-1.0	-7.1
50 Cal. SST®-ML™ Lock-N-Load® Speed Sabot®	250 gr.	67270	2250	2031	1852	1684	1529	1389	2735	2290	1904	1574	1297	1070	-1.5	1.8	3.0	1.7	-2.7	-11.0
50 Cal. SST®-ML™ Low Drag Sabot	250 gr.	67273	2250	2031	1852	1684	1529	1389	2735	2290	1904	1574	1297	1070	-1.5	1.8	3.0	1.7	-2.7	-11.0
50 Cal. MonoFlex® Lock-N-Load® Speed Sabot®	250 gr.	67269	2250	2031	1852	1684	1529	1389	2735	2290	1904	1574	1297	1070	-1.5	1.8	3.0	1.7	-2.7	-11.0
50 Cal. MonoFlex® High Speed Low Drag Sabot	250 gr.	67274	2250	2031	1852	1684	1529	1389	2735	2290	1904	1574	1297	1070	-1.5	1.8	3.0	1.7	-2.7	-11.0
50 Cal. SST®-ML™ Lock-N-Load® Speed Sabot®	300 gr.	67271	2130	1974	1826	1686	1554	1433	3022	2597	2221	1893	1609	1368	-1.5	1.9	3.0	1.6	-2.9	-11.1
50 Cal. SST®-ML™ Low Drag Sabot	300 gr.	67263	2130	1974	1826	1686	1554	1433	3022	2597	2221	1893	1609	1368	-1.5	1.9	3.0	1.6	-2.9	-11.1

All data developed in a stock T/C Omega inline muzzleloader with 150 gr. charges except when noted. Zero your rifle 3" high at 100 yards for a 6" shooting window to 200 yards with 3 pellets or 150 gr. charges.

Shotgun Slug Ballistics

Shotgun Slug Description			Velocity (fps)						Energy (ft/lb)						Trajectory Tables (inches)				
AMMO DESCRIPTION	BULLET	ITEM #	MUZ	50 yd	100 yd	150 yd	200 yd	MUZ	50 yd	100 yd	150 yd	200 yd	MUZ	50 yd	100 yd	150 yd	200 yd		
12 GA SST® Shotgun Slug 2¾"	300 gr. FTX®	8623	2000	1814	1641	1483	1342	2664	2192	1795	1465	1199	-1.5	1.9	2.6	0.0	-6.5		
12 GA Superformance® Shotgun Slug 2¾"	300 gr. MonoFlex®	86236	1950	1742	1552	1383	1239	2533	2022	1605	1274	1022	-1.5	2.1	2.9	0.0	-7.4		
12 GA Custom Lite® Shotgun Slug 2¾"	300 gr. FTX®	86230	1575	1423	1289	1178	1091	1652	1348	1107	924	793	-1.5	3.6	4.5	0.0	-10.7		
12 GA American Whitetail® Shotgun Slug 2¾"	325 gr. InterLock®	86271	1825	1651	1491	1349	1227	2403	1966	1605	1313	1086	-1.5	0.9	0.0	-4.8	-14.3		
12 GA American Whitetail® Rifled Slug 2¾"	1 oz. Rifled Slug	86234	1600	1210	997	882	—	2484	1420	965	754	—	-0.5	2.8	0.0	-11.4	—		
12 GA American Gunner® Reduced Recoil Rifled Slug 2¾"	1 oz. Rifled Slug	86231	1300	1038	907	816	—	1640	1046	798	647	—	-1.5	0.0	-6.5	-23.6	—		
20 GA SST® Shotgun Slug 2¾"	250 gr. FTX®	86232	1800	1628	1471	1331	1212	1798	1471	1201	983	815	-1.5	2.6	3.3	0.0	-8.2		
20 GA Superformance® Shotgun Slug 2¾"	250 gr. MonoFlex®	86237	1800	1628	1471	1331	1212	1798	1471	1201	983	815	-1.5	2.6	3.3	0.0	-8.2		
20 GA Custom Lite® Shotgun Slug 2¾"	250 gr. FTX®	86233	1600	1452	1321	1208	1118	1421	1171	968	810	694	-1.5	3.4	4.2	0.0	-10.1		

Shotgun Ballistics

AMMO DESCRIPTION	SHOT SIZE	SHELL LENGTH	ITEM #	Velocity (fps) muzzle
12 GA Varmint Express® 2¾"	#4 Buck	2¾"	86243	1350
12 GA Critical Defense® 2¾"	00 Buck (8 Pellets)	2¾"	86240	1600
12 GA American Gunner® 2¾"	00 Buck (8 Pellets)	2¾"	86274	1350
12 GA Hornady BLACK™ 2¾"	00 Buck (8 Pellets)	2¾"	86249	1600
12 GA Heavy Magnum® Turkey 3"	#4	3"	86242	1300
12 GA Heavy Magnum® Turkey 3"	#5	3"	86241	1300

AMMO DESCRIPTION	SHOT SIZE	SHELL LENGTH	ITEM #	Velocity (fps) muzzle
12 GA Heavy Magnum® Turkey 3"	#6	3"	86244	1300
12 GA Heavy Magnum® Coyote 3"	BB	3"	86222	1300
12 GA Heavy Magnum® Coyote 3"	00 Buck	3"	86224	1300
20 GA Heavy Magnum® Turkey 3"	#5	3"	86248	1150
410 Critical Defense® Triple Defense™	FTX® Slug & 2 round balls	2½"	86238	750

12 gauge shotgun ballistics are established with a 30" SAAMI standard test barrel. 20 gauge shotgun ballistics are established with a 26" SAAMI standard test barrel.

HORNADY MANUFACTURING COMPANY TRADEMARKS INCLUDE:

- | | | | | | | | | | |
|-------------------------------|-----------------------|---------------|------------------------|-----------------------|----------------|---------------------------|------------------------------|------------------|--------------------------|
| 366 AP™ | Cam Lock™ | DGX® | HAP® | Iron Press® | Lock-N-Load® | Outfitter® | Sonic Cleaner™ | Super Shock Tip™ | Universal Bullet Feeder™ |
| Accurate, Deadly, Dependable® | Close Quarters™ | ELD® Match | Heat Shield® | Key Lock™ Safe | Speed Sabot® | Positive Priming™ System | Speed Kills® | Sure-Loc™ | Varmint Express® |
| A-MAX® | Cowboy™ | ELD-X® | Heavy Magnum® | LEVERevolution® | Low Drag™ | Powder Through™ Expanders | Speed Sabot® | SX® | Varmint™ |
| American Gunner® | Critical Defense® | FlexLock® | Hornady Action Pistol™ | Light Magnum® | Mach 2® | PPS™ | SST® | TAP® FPD™ | Versatite® |
| American Whitetail® | Critical Duty® | Flex Tip® | Hornady BLACK® | LNL® | Match™ | Precision Hunter® | SST® ML™ | Team Hornady® | V-MAX® |
| AMP® | Custom™ | FPB® | Hornady® | L-N-L® | Micro Just™ | PTX™ | Steel Match® | TriPoint™ | VX™ |
| AP™ | Custom™ International | Frontier® | Hornady® | L-N-L® Speed Sabot® | ML™ | Rapid® Safe | SUB-X® | Triple Defense® | XTP® |
| A-Tip™ | Custom™ Lite® | FTX® | Hornady Security® | Lock-N-Load® | MonoFlex® | Rapid Rack® | Super Explosive™ | Ultra-Low Drag™ | XTP® Mag™ |
| Auto Charge® | Dangerous Game™ | Full Boar® | Hot Tub® | Lock-N-Load® Classic™ | New Dimension™ | Reduced Recoil™ | Superformance® | Unique™ | Zip Spindle™ |
| Barrier™ | DGS® | GMX® | InterBond® | InterLock® | NTX® | | Superformance® International | | Zombie Max® |
| | | Great Plains® | | | One Shot® | | | | |

Handgun Ammunition Product Lines:

AG American Gunner™

CD Critical Defense®

CDL Critical Defense® Lite

DUTY Critical Duty®

C Custom™

HH Handgun Hunter™

LEV LEVERevolution®

Handgun Ballistics

Ammo Description			Velocity (fps)			Energy (ft/lb)				
CARTRIDGE	BULLET	ITEM #	BARREL LENGTH	MUZ	50 yd	100 yd	MUZ	50 yd	100 yd	
CD	22 WMR	45 gr. FTX®	83200	1 7/8 V"	1000	920	857	100	85	73
CD	25 Auto	35 gr. FTX®	90014	2"	900	805	728	63	50	41
C	25 Auto	35 gr. XTP®	90012	2"	900	813	742	63	51	43
CD	32 Auto	60 gr. FTX®	90063	4"	1000	882	797	133	104	85
C	32 Auto	60 gr. XTP®	90062	4"	1000	905	833	133	109	92
CD	32 NAA	80 gr. FTX®	90070	4"	1000	933	880	178	155	137
CD	32 H&R	80 gr. FTX®	90060	4"	1150	1039	963	235	192	165
CD	327 Federal Mag	80 gr. FTX®	90061							
AG	380 Auto	90 gr. XTP®	90104	4"	1000	912	845	200	166	143
CD	380 Auto	90 gr. FTX®	90080	4"	1000	912	845	200	166	143
CDL	9mm Luger	100 gr. FTX®	90240	4"	1125	1003	922	281	224	189
AG	9mm Luger	115 gr. XTP®	90244	4"	1155	1038	958	341	275	234
CD	9mm Luger	115 gr. FTX®	90250	4"	1135	1025	949	329	268	230
DUTY	9mm Luger +P	124 gr. FlexLock®	90216	4"	1175	1081	1012	380	322	282
AG	9mm Luger +P	124 gr. XTP®	90224	4"	1175	1074	1001	380	317	276
C	9mm Luger	124 gr. XTP®	90242	4"	1110	1027	965	339	290	257
DUTY	9mm Luger	135 gr. FlexLock®	90236	4"	1010	960	918	306	276	253
DUTY	9mm Luger +P	135 gr. FlexLock®	90226	4"	1110	1038	983	369	323	289
C	9mm Luger	147 gr. XTP®	90282	4"	975	934	899	310	285	264
SUB	9mm Luger	147 gr. XTP®	90287	4"						
HH	9mm Luger +P	115 gr. MonoFlex®	90281	4"						
C	357 Sig	147 gr. XTP®	9131	4"	1225	1132	1060	490	418	367
DUTY	357 Sig	135 gr. FlexLock®	91296	4"	1225	1112	1031	450	371	319
CDL	38 Special	90 gr. FTX®	90300	4"	1200	1037	938	288	215	176
CD	38 Special	110 gr. FTX®	90310	4" V	1010	939	882	249	215	190
CD	38 Special +P	110 gr. FTX®	90311	4" V	1090	996	928	290	242	210
AG	38 Special	125 gr. XTP®	90324	4" V	900	856	817	225	203	185
C	38 Special	158 gr. XTP®	90362	4" V	800	775	751	225	210	198
CD	357 Magnum	125 gr. FTX®	90500	8" V	1500	1312	1163	624	478	376
AG	357 Magnum	125 gr. XTP®	90504	8" V	1500	1313	1165	624	479	377
HH	357 Magnum	130 gr. MonoFlex®	9052	8" V						
DUTY	357 Magnum	135 gr. FlexLock®	90511	8" V	1275	1150	1058	487	396	336
LEV	357 Magnum	140 gr. FTX®	92755	8" V	1440	1281	1154	645	510	414
C	357 Magnum	158 gr. XTP®	90562	8" V	1250	1149	1072	548	463	403
CD	9 x 18mm Makarov	95 gr. FTX®	91000	4"	1000	913	846	211	176	151
C	40 S&W	155 gr. XTP®	9132	4"	1180	1060	978	479	387	329

Ammo Description			Velocity (fps)			Energy (ft/lb)				
CARTRIDGE	BULLET	ITEM #	BARREL LENGTH	MUZ	50 yd	100 yd	MUZ	50 yd	100 yd	
CD	40 S&W	165 gr. FTX®	91340	3"	1045	971	914	400	345	306
DUTY	40 S&W	175 gr. FlexLock®	91376	4"	1010	948	899	396	350	314
AG	40 S&W	180 gr. XTP®	91364	4"	950	903	862	361	326	297
SUB	40 S&W	180 gr. XTP®	91369	4"						
HH	40 S&W	135 gr. MonoFlex®	91361	4"						
C	10mm Auto	155 gr. XTP®	9122	5"	1410	1224	1090	684	516	409
DUTY	10mm Auto	175 gr. FlexLock®	91256	5"	1160	1061	990	523	437	381
C	10mm Auto	180 gr. XTP®	9126	5"	1275	1146	1052	650	525	443
HH	10mm Auto	135 gr. MonoFlex®	91267	5"						
LEV	41 Rem Mag	190 gr. FTX®	9078	10"	1620	1432	1272	1107	865	682
C	41 Rem Mag	210 gr. XTP®	9077	10"	1545	1383	1244	1113	892	722
C	44-40 Cowboy	205 gr. Cowboy™	9075	7½" V	725	689	655	239	216	195
CD	44 Special	165 gr. FTX®	90700	2½" V	900	847	802	297	263	235
C	44 Rem Mag	200 gr. XTP®	9080	7½" V	1500	1332	1194	999	788	633
HH	44 Rem Mag	200 gr. MonoFlex®	9083	7½" V						
LEV	44 Rem Mag	225 gr. FTX®	92782	7½" V	1410	1233	1102	993	760	607
C	44 Rem Mag	240 gr. XTP®	9085	7½" V	1350	1230	1133	971	806	684
C	44 Rem Mag	300 gr. XTP®	9088	7½" V	1150	1083	1030	881	781	706
AG	45 Auto	185 gr. XTP®	90904	5"	970	911	862	386	341	305
CD	45 Auto	185 gr. FTX®	90900	3"	900	853	811	333	299	270
C	45 Auto	200 gr. XTP®	9112	5"	900	856	817	360	325	296
DUTY	45 Auto +P	220 gr. FlexLock®	90926	5"	975	927	887	464	420	384
C	45 Auto +P	230 gr. XTP®	9096	5"	950	908	871	461	421	388
SUB	45 Auto	230 gr. XTP®	90971	5"						
CD	45 Colt	185 gr. FTX®	92790	3" V	920	870	826	348	311	280
C	45 Colt	255 gr. Cowboy™	9115	4¾" V	725	687	651	298	267	240
LEV	45 Colt	225 gr. FTX®	92792	4¾" V	960	903	855	460	407	366
HH	454 Casull	200 gr. MonoFlex®	9151	7½" V						
C	454 Casull	240 gr. XTP® Mag	9148	7½" V	1900	1678	1478	1924	1500	1164
C	454 Casull	300 gr. XTP® Mag	9150	7½" V	1650	1490	1348	1813	1480	1210
C	460 S&W Mag	200 gr. FTX®	9152	8 3/8"	2200	1948	1715	2149	1673	1288
HH	460 S&W Mag	200 gr. MonoFlex®	9153	8 3/8"						
C	480 Ruger	325 gr. XTP® Mag	9138	7½"	1350	1191	1077	1315	1024	837
C	50 AE	300 gr. XTP®	9245	6"	1475	1251	1092	1449	1043	795
C	500 S&W Mag	300 gr. FTX®	9249	8½"	1950	1653	1396	2533	1819	1298
C	500 S&W Mag	500 gr. FP-XTP®	9252	8½"	1300	1178	1085	1876	1541	1308