

#48385

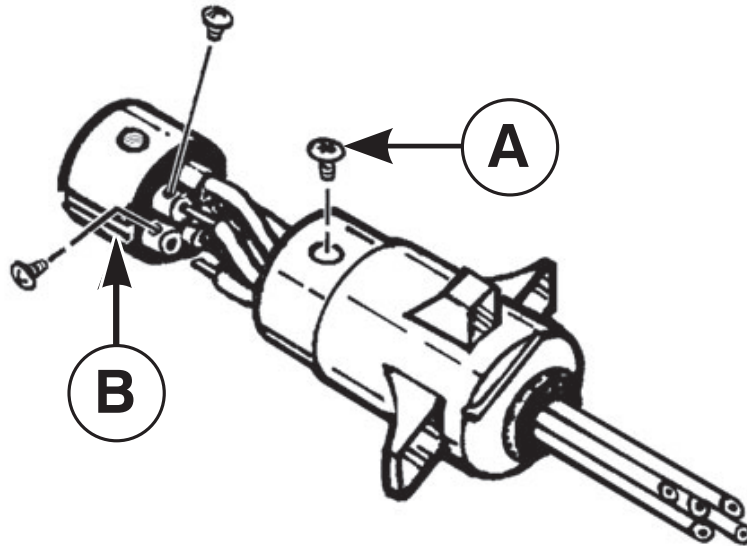

1. Loosen set screw (A) on the trailer end plug and remove housing. Route wires through housing. Strip 1/4" from wire ends and tightly secure them to the plug terminals. Align plug keyway (B) with housing key and insert plug into housing. Tighten set screws.
2. Attach wires to the corresponding trailer function wires.

NOTE: It is important to attach wires to plug in the same positions as found on the car end socket.