

TERMINATOR[™]X

TERMINATOR[™]X MAX

MPFI FUEL INJECTION SYSTEM

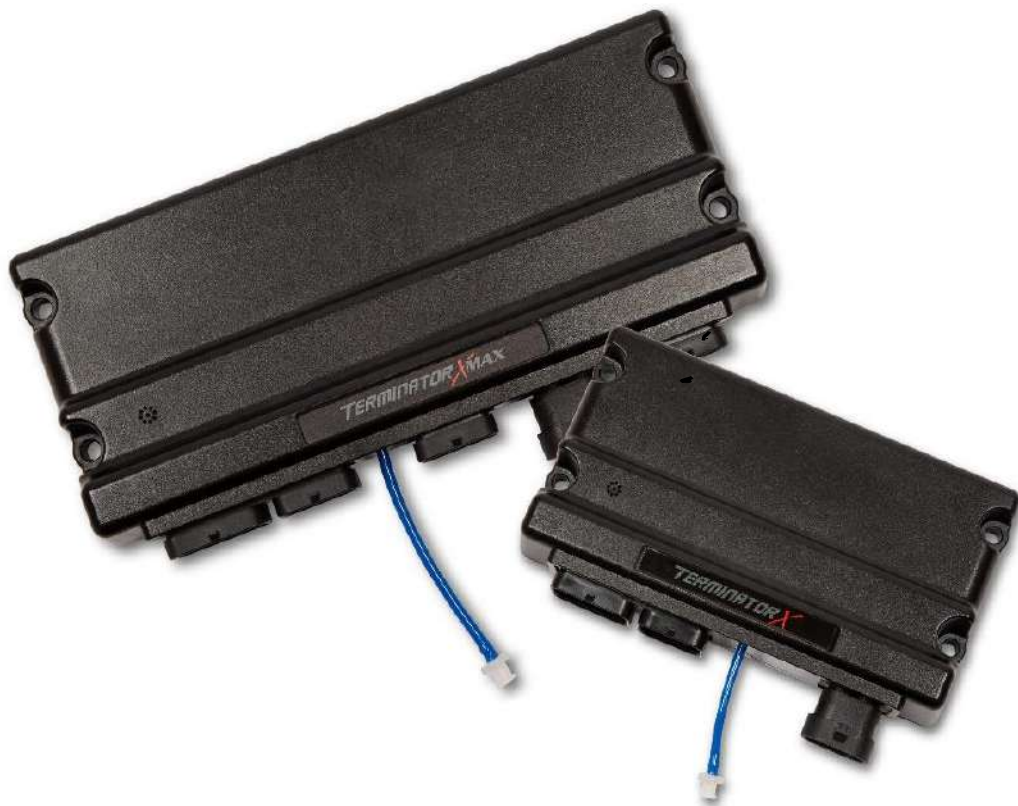

PART NUMBERS

550-903 thru 905, 550-916 thru 918 & 550-926 thru 931

INSTALLATION & TUNING MANUAL – 199R11760

NOTE: These instructions must be read and fully understood before beginning installation. If this manual is not fully understood, installation should not be attempted. Failure to follow these instructions, including the pictures may result in subsequent system failure.

TABLE OF CONTENTS:

1.0 INTRODUCTION.....	3
2.0 WARNINGS, NOTES, AND NOTICES.....	3
3.0 PARTS IDENTIFICATION.....	4
4.0 ADDITIONAL ITEMS REQUIRED FOR INSTALLATION.....	4
5.0 TOOLS REQUIRED FOR INSTALLATION.....	5
6.0 REMOVAL OF EXISTING COMPONENTS.....	5
7.0 TERMINATOR X MPFI SYSTEM INSTALLATION.....	5
7.1 Fuel Pump, Fuel Line, and Filter Installation.....	5
7.2 Oxygen Sensor Installation.....	5
7.2.1 Oxygen Sensor Mounting Procedure.....	6
7.3 ECU Mounting.....	6
8.0 WIRING.....	6
8.1 Important Wiring “Do’s and Don’ts”.....	6
9.0 WIRING HARNESS INSTALLATION.....	7
9.1 Main Power/Battery Connection.....	7
10.0 PRIMARY HARNESS INSTALLATION AND SENSOR CONNECTIONS.....	7
10.1 ECU Connectors.....	8
10.2 Harness Routing.....	8
10.3 Sensor Connections & Outputs.....	8
10.3.1 Oil Pressure Sensor.....	8
10.3.2 Coolant Temperature Sensor (CTS).....	9
10.3.3 Wide Band Oxygen Sensor (WB02) – need text about adapter harness – need pics.....	9
10.3.4 Fuel Pressure (Fuel).....	9
10.3.5 Manifold Air Temperature (MAT).....	9
10.3.6 Cam Sensor.....	10
10.3.7 Crank Sensor.....	10
10.3.8 Knock Sensors.....	10
10.3.9 Manifold Absolute Pressure sensor (MAP).....	10
10.3.10 Throttle Position Sensor (TPS).....	11
10.3.11 Idle Air Control (IAC).....	11
10.3.12 Fuel Injectors.....	11
10.3.13 Ignition Coils.....	12
10.3.14 Coil Ground Wires.....	12
10.3.15 Handheld Connections - (CAN1).....	12
11.0 LOOSE WIRES.....	13
12.0 ADDITIONAL OUTPUTS.....	13
13.0 TRANSMISSION HARNESS.....	14
13.1 Transmission Wiring.....	14
14.0 DRIVE-BY-WIRE HARNESS.....	15
14.1 Overview.....	15
14.2 Warnings!.....	15
14.3 Installation.....	15
14.4 System Safeties.....	16
14.5 Throttle Body “Limp Home” Position.....	16
14.6 Drive-By-Wire DO’S and DON’TS.....	16
14.7 Wiring.....	16
15.0 PREVIOUS INSTALLATION REQUIRED.....	17
16.0 TERMINATOR™ INSTRUCTIONS AND TUNING.....	17
17.0 INITIAL POWER-UP.....	17
18.0 HANDHELD NAVIGATION & USE.....	17
18.1 Making Adjustments.....	17
19.0 HOME SCREEN.....	18
20.0 CALIBRATION WIZARD.....	19
21.0 TPS AUTOSET.....	23
22.0 SENSOR VERIFICATION.....	24
23.0 STARTUP.....	24
24.0 AFTER-STARTUP.....	25
25.0 IDLE SETTING/CABLE OPERATED THROTTLE PLATE SETTING.....	25
26.0 SELF-TUNING.....	26

1.0 INTRODUCTION

Holley Performance Products has written this manual for the installation of the **LS TERMINATOR X™ MPFI** fuel injection system. This manual contains the information necessary for the installation of the hardware contained in this kit, which includes the ECU, wiring, and 3.5" touch screen. It also contains basic tuning information. This instruction sheet does not include installation instructions for the fuel system (pump, filters, regulators and lines). Please read all the **WARNINGS** and **NOTES**, as they contain valuable information that can save you time and money. It is our intent to provide the best possible products for our customer; products that perform properly and satisfy your expectations. By using this number, you may obtain any information and/or parts assistance that you may require. Please have the part number of the product you purchased when you call.

2.0 WARNINGS, NOTES, AND NOTICES

NOTE: This system does not contain fuel system components that are required including the fuel pump, fuel filters, fuel pressure regulator, and lines. Holley offers complete kits can be purchased separately (526-1, 526-2, 526-3, & 526-4).

NOTE: This system is designed for stock and mild cam, naturally aspirated LS engines.

WARNING! The **LS TERMINATOR X MPFI** systems consist of a number of sophisticated components. Failure of any one component does not constitute, nor does it justify, warranty of the complete system. Individual service items are available for replacement of components. If assistance is required or if you need further warranty clarification, you can call Holley Technical Service at the number shown above.

WARNING! To preserve warranty, these instructions must be read and followed thoroughly and completely before and during installation. It is important that you become familiar with the parts and the installation of the **LS TERMINATOR X MPFI** system before you begin. Failure to read and understand these instructions could result in damage to **LS TERMINATOR X MPFI** components that are not covered by the warranty and could result in serious personal injury and property damage.

WARNING! The oxygen sensor in this kit is recommended for use with **ONLY** unleaded fuel. Use of leaded fuels will degrade the oxygen sensor and will result in incorrect exhaust gas oxygen readings and improper fuel delivery. Failure to follow these directions does not constitute the right to a warranty claim.

WARNING! Failure to follow all of the above will result in an improper installation, which may lead to personal injury, including death, and/or property damage. Improper installation and/or use of this or any Holley product will void all warranties.

WARNING! Use of some RTV silicone sealers will destroy the oxygen sensor used with this product. Ensure the RTV silicone sealant you use is compatible with oxygen sensor vehicles. This information should be found on the RTV package.

WARNING! For the safety and protection of you and others, only a trained mechanic having adequate fuel system experience must perform the installation, adjustment, and repair. It is particularly important to remember one of the very basic principles of safety: fuel vapors are heavier than air and tend to collect in low places where an explosive fuel/air mixture may be ignited by any spark or flame resulting in property damage, personal injury, and/or death. Extreme caution must be exercised to prevent spillage and thus eliminate the formation of such fuel vapors.

WARNING! This type of work **MUST** be performed in a well-ventilated area. Do not smoke or have an open flame present near gasoline vapors or an explosion may result.

3.0 PARTS IDENTIFICATION

<u>ITEM</u>	<u>DESCRIPTION</u>	<u>QTY</u>	<u>SERVICE PART</u>
1A	TERMINATOR X™ ECU (Kits 550-903, 904 & 905)	1	
1B	TERMINATOR X MAX™ ECU (Kits 550-916 thru 918, 550-926 thru 931)	1	
2	TERMINATOR X Hand-Held Controller	1	553-201
3	Main Power Harness	1	558-308
4A	Main Engine Harness (LS1 - 24x)	1	558-102
4B	Main Engine Harness (LS2/3/7 - 58x)	1	558-103
5A	Injector Harness (EV1)	1	558-200
5B	Injector Harness (EV6)	1	550-201
5C	Injector Harness (Truck)	1	558-214
6	Input/Output Harness	1	558-462
7A	Drive-By-Wire Harness	1	558-406
7B	Drive-By-Wire Harness – Early Truck	1	558-429
8	4L60E/4L80E Transmission Harness	1	558-405
9	Wideband O2 Adapter Harness	1	558-463
10	Quick Turn MAP Sensor Adapters (1/8", 3/16", 1/4")	1	543-121
11	Oxygen Sensor	1	554-155
12	Oxygen Sensor Weld Ring	1	534-49
<u>Service Parts:</u>			
13	40 AMP Relay	1	534-26
<u>Optional Parts:</u>			
14	100 PS Fuel Pressure or Oil Pressure Sender	1	554-102
15	LS MAP Sensor Adapter Harness	1	558-416
16	USB to CAN Tuning Cable	1	558-443



4.0 ADDITIONAL ITEMS REQUIRED FOR INSTALLATION

- Fuel System
- Return Fuel Lines

A 0-100 psi fuel gauge or pressure transducer is recommended to check for proper fuel pressure. PN 554-102 is a 0-100 PSI pressure sensor that can be purchased as well that will plug into the TERMINATOR X™ harness to check and monitor fuel pressure. It requires a 1/8" NPT port for installation (Holley fuel pressure regulators have an 1/8" NPT port)

These kits are designed to use factory sensors and injectors. Any deviation from this may require different harnesses. Please contact Holley Technical Services if your project is using any non-OEM parts.

5.0 TOOLS REQUIRED FOR INSTALLATION

- Standard wrench set
- Medium blade screwdriver
- Drill and assorted bit sizes
- Factory Service Manual for your vehicle
- Small blade screwdriver
- #2 Phillips screwdriver
- Hole saw (2") (depending on ECU location)
- O2 Bung Installation (drilling, welding)
- Allen Wrench set
- Digital Volt meter
- Terminal crimping tool

An assistant is necessary for some installation and adjustment procedures and should be present for safety reasons.

6.0 REMOVAL OF EXISTING COMPONENTS

1. Disconnect the battery.
2. Remove the existing OEM main wiring harness and injector harness. Consult the factory service manual for details on how to properly remove the harness.

7.0 TERMINATOR X MPFI SYSTEM INSTALLATION

7.1 Fuel Pump, Fuel Line, and Filter Installation

A complete high pressure EFI fuel system must be installed for the TERMINATOR X™. The pump should be capable of supplying 255 liters/hour or 400 lb./hr. of fuel at the **Terminator X system requirement of 60 PSI**. If using an in-line fuel pump, there should be a coarse pre-filter before the pump. All systems should contain a 10 micron post filter after the fuel pump. An EFI fuel pressure regulator is required. It should be installed after the fuel rail. See **Figure 4** below for proper fuel system plumbing.

Holley offers multiple fuel system kits. These kits contain all components except the return line. Examples of these kits are:

- 526-1 – Braided Stainless Lines, Billet Pump, Regulator, and Filters
- 526-2 – Pro-Lite 350 Hose, Billet Pump, Regulator, and Filters
- 526-3 – Super Stock Hose, Billet Regulator, 12-920 Fuel Pump, and Filter
- 526-4 – Super Stock Hose, Billet Regulator, 12-920 Pump, and Metal Filters

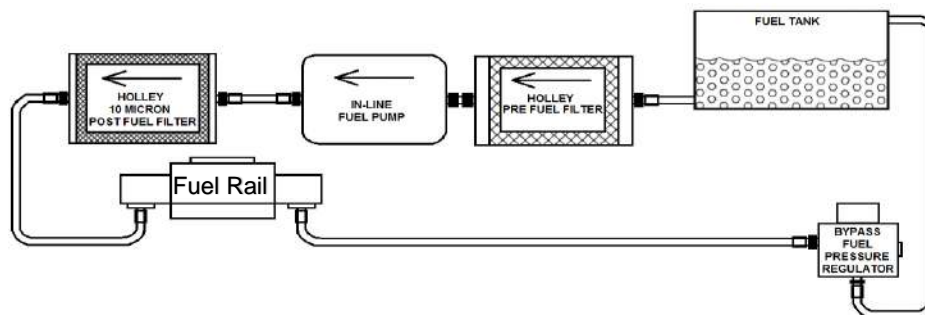

Figure 4

7.2 Oxygen Sensor Installation

The oxygen sensor should be mounted at a point where it can read a good average of all the cylinders on one bank. This would be slightly after all the cylinders merge. Do NOT mount the sensor far back in the exhaust as this will negatively impact closed loop operation response. If you have long tube headers, mount the sensor approximately 1-10" after the collector. You must have no less than 18 – 24" of exhaust pipe after the sensor.

TERMINATOR X™ EFI systems come with a Bosch LSU 4.9 wideband oxygen sensor (**Item 11**). Make sure your sensor looks like **Figure 5**.



Figure 5

7.2.1 Oxygen Sensor Mounting Procedure

NOTE: Never run the engine with the oxygen sensor installed if it is not plugged in and powered by the ECU, or it will be damaged. If you need to plug the hole temporarily, use an O₂ sensor plug or a spark plug with an 18mm thread.

NOTE: Someone with experience in welding exhaust systems should install the oxygen sensor boss. Any competent exhaust shop will be able to perform this task at a minimum cost. (Note: If you weld on the car, make sure all wiring to the ECU is disconnected, and it's best to remove the ECU from the vehicle when welding).

WARNING! Use of leaded fuel will degrade an oxygen sensor. Prolonged use is not recommended unless periodic replacement is performed.

WARNING! Use of some RTV silicone sealers will destroy the oxygen sensor used with this product. Ensure the RTV silicone sealant you use is compatible with oxygen sensor vehicles. This information should be found on the RTV package.

1. Locate a position for the oxygen sensor as close to the engine as possible. If your vehicle has catalytic converters, the oxygen sensor MUST be located between the engine and the catalytic converters.

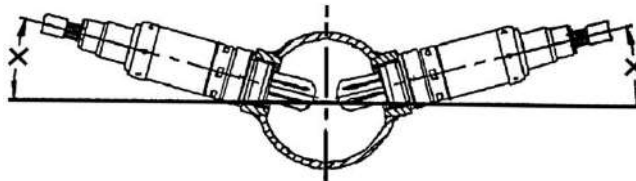

Figure 6

NOTE: The oxygen sensor should be mounted in such a way that the condensation in the exhaust tubing will not enter the sensor. Mount the O₂ sensor in the upper half of the exhaust tubing, with the angle "x", shown above, being greater than 10°. **Figure 6** indicates that the sensor can be mounted on either side of the exhaust tubing.

2. Drill a 7/8" hole in the location picked for the sensor. Weld the threaded boss into the 7/8" hole. Weld all the way around the boss to insure a leak proof connection. Install the oxygen sensor into the threaded boss and tighten securely. It is a good idea to add anti-seize to the threads to aid in removal. Do not get any anti-seize on the tip of the sensor.
3. On vehicles equipped with an AIR pump, the oxygen sensor must be mounted before the AIR injection into the exhaust, or the AIR pump must be disconnected. Holley recommends that if the AIR is injected into both exhaust manifolds, mount the oxygen sensor into the pipe immediately after the exhaust manifold. Disconnect the AIR pump tube from the exhaust manifold and plug both ends. Check with local ordinances for the legality of this procedure in your area.

WARNING! Failure to disconnect the AIR pump or locating the oxygen sensor downstream from AIR injection will result in an extremely rich mixture, which could cause drivability problems and severe engine damage.

7.3 ECU Mounting

The ECU can be mounted inside the passenger compartment (preferable location) or in the engine compartment. If mounted in the engine compartment, follow these guidelines:

- The ECU should be located such that it isn't being directly hit by water or road debris.
- It should also be located such that it isn't extremely close to exhaust manifolds or headers.
- It should be mounted such that it is as far away from spark plug wires, CD ignition boxes, or other "electrically noisy" devices as is reasonably possible.
- Make sure the connector end of the ECU is pointed DOWN such that water can't make its way into the ECU terminals.

Do not over-tighten mounting hardware if the ECU is not mounted on a flat surface.

8.0 WIRING

This section overviews how to properly install the wiring harnesses for this system.

8.1 Important Wiring "Do's and Don'ts"

An EFI system depends heavily on being supplied a clean and constant voltage source. The grounds of an electrical system are just as important as the power side.

TERMINATOR X™ ECU's contain multiple processing devices that require clean power and ground sources. The wiring harnesses for them must be installed in such a manner that they are separated from "dirty" power and ground sources.

DO'S

- Install the main power and ground directly to the battery. *To the POSTS/TERMINALS, not to any other place!*
- Keep sensor wiring away from high voltage or “noisy/dirty” components and wiring, especially secondary ignition wiring (plug wires), ignition boxes and associated wiring. It is best that the plug wires not physically contact any EFI wires.
- Properly crimp or crimp and solder any wire connections. Apply quality heat shrink over any of these connections.
- It is critical that the engine has a proper ground connection to the battery and chassis.

DON'TS

- NEVER run high voltage or “noisy/dirty” wires in parallel (bundle/loom together) with any EFI sensor wiring. If wires need to cross, try to do so at an angle.
- Do not use the electric fan outputs to directly power a fan. They must only trigger a relay.
- Do not use improper crimping tools.
- Don't use things like “t-taps”, etc. Use proper crimpers/solder and heat shrink.
- It is never recommended to splice/share signal wires (such as TPS, etc.) between different electronic control units (i.e. “piggyback”).
- Do not connect the red/white switched +12V wire to “dirty” sources, such as the ignition coil, audio systems, or 12V sources connected to HID head lamps.

9.0 WIRING HARNESS INSTALLATION

9.1 Main Power/Battery Connection

The TERMINATOR X™ ECU has a main battery power and ground connector on the right side of the ECU. The right position, Terminal “A” is the ground (black wire). The black wire should go to the negative post DIRECTLY on the battery. The left position, Terminal “B” is the positive terminal (red wire). The red wire should go to the positive post DIRECTLY on the battery. If you have a “dual post” battery, it is a great idea to purchase separate posts/studs to connect the ECU power and ground to the non-used terminals. Always use the fused power cable (Item 3) with the proper connectors supplied by Holley only. **Don't connect to the ECU until after ALL wiring and installation is performed.**



Figure 7

10.0 PRIMARY HARNESS INSTALLATION AND SENSOR CONNECTIONS

These sections review the Main Harness installation and sensor connections that must be completed. The Main Harness (Item 4) is the primary harness that supports all the primary engine sensors, fuel and ignition. There are two main connectors for this harness that plug into the ECU.

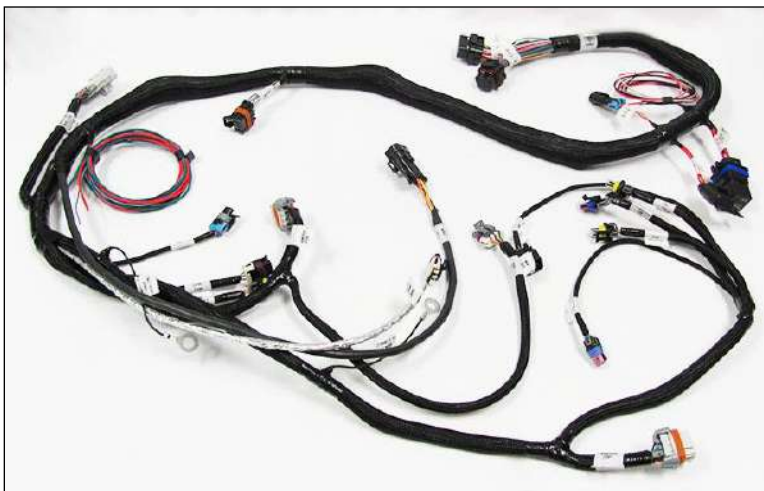

Figure 8

10.1 ECU Connectors

TERMINATOR™ ECU – The TERMINATOR™ ECU has **two** main connectors:

- **J1A** - The first connector next to the USB connector is the “J1A” connector (34 pin). This connector is primarily an “Input” connector. It contains all the sensor inputs and wide band oxygen sensor control.
- **J1B** - The second connector is the “J1B” connector (26 pin). This connector is the “output” connector. It has 8 injector outputs and outputs for other devices.
- **J3** – Connection point for the Drive-By-Wire harness.
- **J4** – Connection point for the Transmission harness



10.2 Harness Routing

If the ECU is mounted in the interior, it will have to be routed through the firewall into the engine compartment. Use a 2" hole saw to create a hole in a desired location if no other point of access is available. Use a grommet for a 2" hole to seal this area. Holley recommends Earl's part number 29G001ERL

If the ECU is mounted in the engine compartment, the 3.5" Touch Screen cable will have to be routed to the “CAN” connector on the main harness (located near the ECU connector main connector). This is assuming you want to access the hand-held module after startup. This will require routing the small CAN connector somewhere through the firewall.

Connect the J1A and J1B connectors of the main harness into the ECU.

About 18" from the ECU main connectors is a 40A Relay. This powers the injectors and fuel pump. There is also a 20 amp fuse for the injectors and fuel pump pre-installed in this location.

10.3 Sensor Connections & Outputs

The following indicates the primary sensors that are required to be connected. Each connector on the main harness is labeled with the sensor name. The name on this label for each sensor is in parenthesis below.

10.3.1 Oil Pressure Sensor

[OPTIONAL] Connect to some factory Oil Pressure sensors, located at the rear of the engine. If your factory sensor does not plug in, utilize the Holley 554-102 0-100 psi transducer

Note: LS2 GTO & F-body Oil Pressure sensors have a unique pin-out and cannot be used with the Terminator X Harness



Figure 9 Oil Pressure

10.3.2 Coolant Temperature Sensor (CTS)

[Required] Connect the CTS connector to the sensor which should be located in the front of the driver's side cylinder head.



Figure 10 CTS

10.3.3 Wide Band Oxygen Sensor (WB02)

[Required] Connect to the oxygen sensor previously installed. There is an adapter harness included in the kit which allows the Bosch 4.9 sensor to plug into the main engine harness. If you need an extension cable, one is available from Holley (P/N 534-199). The TERMINATOR X™ systems are intended to be used with a Bosch LSU 4.9 wide band oxygen sensor supplied by Holley. Service part number 554-155.



Figure 11 WB02

10.3.4 Fuel Pressure (Fuel)

[Optional] A fuel pressure transducer connector is pre-installed in the main harness. The system is plug-and-play configured for a Holley 100 PSI pressure transducer (can be purchased under PN 554-102). If these are not connected to a pressure transducer, the Fuel Pressure shown on the hand held display will not be accurate. This will not cause any issues. Connect to the transducer (if installed).



Figure 12 Fuel Pressure

10.3.5 Manifold Air Temperature (MAT)

[Required] Connect to the MAT sensor located on the intake manifold.

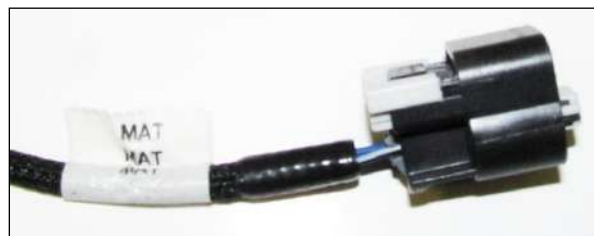

Figure 13 MAT

10.3.6 Cam Sensor

[Required] The cam sensor is located in two different locations, depending on whether the harness is for a 24x or 58x crankshaft. If 24x, the camshaft position sensor is located at the top, rear of the block, at the back of the intake manifold. If 58x, the cam sensor is located in the timing cover on the driver's side. The Holley harness plugs directly into the sensor, not the short pigtail that may be on the engine.



Figure 14 Cam Sensor

10.3.7 Crank Sensor

[Required] The crank sensor should be bundled in some reflective heat shielding. The crank sensor is located behind the starter. It is imperative this cable routed away from heat sources. Connect to the crankshaft position sensor.



Figure 15 Crank Sensor

10.3.8 Knock Sensors

[Optional] Connect to the Knock Sensor(s). Earlier model LS engines will have a knock sensor located in the center valley of the engine. Later model LS engines have knock sensors located on the bottom of the block near the oil pan rails. Knock Sensors are not enabled in Terminator X base calibrations, but may be configured by using Terminator X software.



Figure 16 Knock

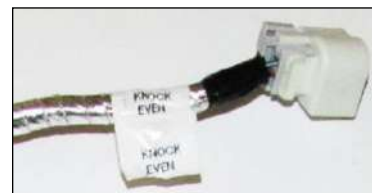

Figure 17 Knock Even

10.3.9 Manifold Absolute Pressure sensor (MAP)

[Required] For naturally aspirated & nitrous engines, connect the 1Bar MAP sensor located on the ECU to an available intake manifold port by using the appropriately sized quick-turn adapter.

Boosted applications will require using a GM 2.5Bar MAP sensor, Part Number 12592525 (or parts store equivalent). Use of the Holley MAP adapter harness (558-416) is also required but not included. (Figure 19).

Many other MAP sensors can be configured for use with Terminator X, but will require custom calibrations to be made via software.

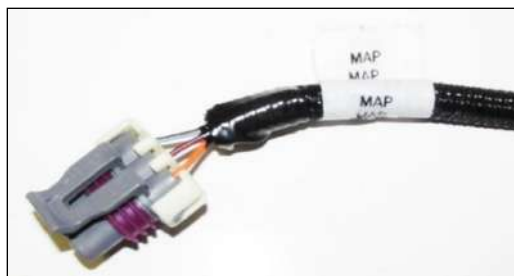

Figure 18 MAP



Figure 19 MAP Adapter

10.3.10 Throttle Position Sensor (TPS)

[Required] Connect to the cable driven throttle body. Service part number 543-111

Note: This connector is not used with a Drive-By-Wire throttle body



Figure 20 TPS

10.3.11 Idle Air Control (IAC)

[Required] Connect to the cable driven throttle body. Service part number 543-34

Note: This connector is not used with a Drive-By-Wire throttle body

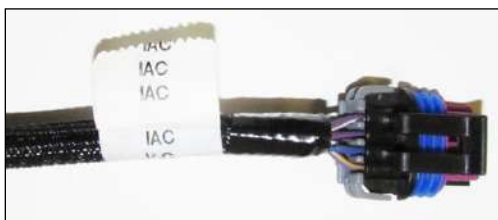

Figure 21 IAC

10.3.12 Fuel Injectors

[Required] The fuel injector harness is labeled by cylinder. Please refer to **Figure 23** below for proper LS cylinder number identification.



Figure 22 Fuel Injectors

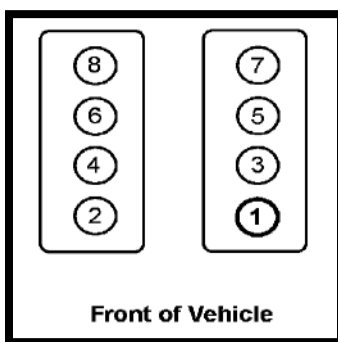

Figure 23

NOTE: Make sure to connect these to the appropriate fuel injector otherwise severe engine damage may occur.

NOTE: Since their introduction, LS engines have been shipped from the factory with 3 different styles of fuel injector connectors. An overview of these various connector styles can be found in Appendix 2.0 of the full Terminator X instruction manual found. If the harness supplied in your kit does not match what your engine has, please contact Holley Tech Service.

10.3.13 Ignition Coils

[Required] Connect the coil connectors into each bank of coils. The driver side connector should be labeled “DIS CONNECTOR ODD”. The passenger side connector should be labeled “DIS CONNECTOR EVEN”. Make sure these are plugged in correctly. If they aren't, the firing order will not occur properly and damage could result.



Figure 24 Ignition Even



Figure 25 Ignition Odd

Holley offers coil harnesses (558-321) which can be used to replace the factory harness for a cleaner installation.

10.3.14 Coil Ground Wires

[Required] There are two coil ground wires. These are labeled “CONNECT TO CLYNDER HEAD ONLY!” There is one on each bank of the engine. They are black wires and have an eyelet crimped on them. These are to be fastened to the rear of each cylinder head. These **MUST** be installed and **MUST** be installed to the head securely. If not, the coils will not be grounded and the engine will run poorly and other issues will occur.



Figure 26 Coil Ground Wires

10.3.15 Handheld Connections - (CAN1)

[Required] The handheld controller is used to create an initial calibration for the system, allows for simple tuning changes to be performed, and is also used to view various information of the EFI system. It should be installed such that the handheld controller can be easily used in the passenger compartment. The handheld plugs directly into the main harness at either connector labeled “CAN”. This connector is located approximately 21 inches from the ECU connector. The handheld does not have to remain in the vehicle or utilized after the vehicle is set up and running properly.

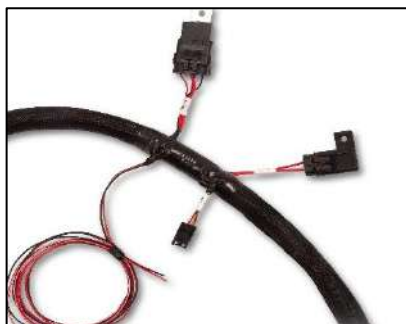

Figure 27 Handheld Connection



Figure 28 Handheld

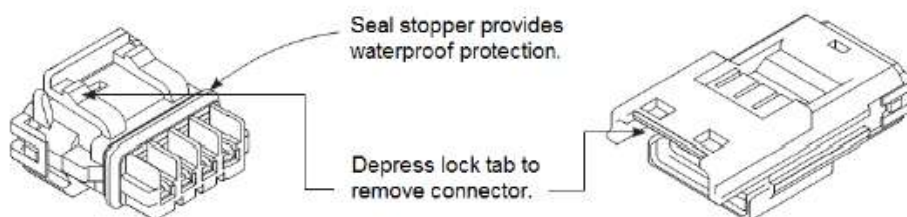

Figure 29 – Handheld CAN connector

11.0 LOOSE WIRES



Figure 30

The following loose wires in the main wiring harness should be connected as follows on all systems. All of these wires come out of the harness about 40" from the ECU connectors except for the "12V Switched" wire.

[Required] 12V Switched – Color = Red/White – Should be connected to a clean +12 volt power source. Power source should only be active when the ignition is on. Make sure source has power when engine is cranking as well (check with voltmeter). Not all sources apply power when the ignition switch is in "cranking" position. This wire is located approximately 7" from the ECU connectors. **DO NOT connect to a "DIRTY" source like an ignition coil!**

[Required] 12V Battery – Color = Red – Should be connected directly to the battery. This powers the fuel pump and fuel injectors. This wire is protected by a fuse in a sealed fuse holder. The fuse holder is located about 18" from the ECU connector. A fuse is pre-installed (20A).

[Optional] 12V Fuel Pump – Color = Green - Used to directly power a fuel pump (+12 volt). **Do not use this wire to power fuel pumps that require over 15 Amps.** Refer to your fuel pump manufacturer for amperage ratings. For high current pumps, use this wire to trigger a separate relay and use larger gauge wire to feed the pump - 10 gauge is recommended. The pump that include with TERMINATOR™ systems draws less than 10 Amps and can be powered directly by this wire. The fuel pump also requires a ground wire. Run a wire from the negative side of the fuel pump. Connect it to a solid chassis/frame ground.

[Required] Chassis Ground – Color = Black – Connect to a chassis ground point that has excellent connectivity with both the engine and battery. There must be good continuity between the connection point and the battery when checked with a digital volt ohm meter (DVOM). This ground should not be connected at the same location as other grounds.

[Optional] Tach Output – Color = Blue with white stripe – This wire provides a 12v square wave output and can be used to trigger a conventional tachometer.

12.0 ADDITIONAL OUTPUTS

Terminator X base calibrations are pre-configured with 3 outputs and one input to be used for the following features:

- Electric Fan #1 output
- Electric Fan #2 output
- Air Conditioning Shutdown at wide open throttle
- IAC Kick input

These outputs are located in the "Input/Output" connector. This is an 8 Pin connector is located about 52 inches from the ECU. A mating harness is included with the system.

The following indicates proper wiring for these features.

Electric Fan #1 output – This output will provide a ground output to trigger a relay used for a cooling fan. This output should never be directly connected to a fan, but the relay that powers the fan. It should be connected to the ground trigger of the relay. This wire is located in pin E of the 8 pin Input/Output connector and is Gray with a Yellow stripe.

Electric Fan #2 output – This output will provide a ground output to trigger a relay used for a cooling fan. This output should never be directly connected to a fan, but the relay that powers the fan. It should be connected to the ground trigger of the relay. This wire is located in pin F of the 8 pin Input/Output connector and is Gray with a Red stripe.

A/C Shutdown – This output will provide a ground output a defined throttle position. This output can be used to trigger a relay that deactivates the A/C at higher throttle positions. This may require the installation of a 5 pole relay in the existing A/C wiring. This wire is located in pin G of the 8 pin Input/Output connector and is Gray with a Black stripe.

IAC Kick input – This input will allow for the Idle Air Control motor to automatically make an increase in steps necessary to avoid a momentary drop in idle speed. This input is a ground located in pin A of the 8 pin Input/Output connector and is White with a Blue stripe.



Figure 31

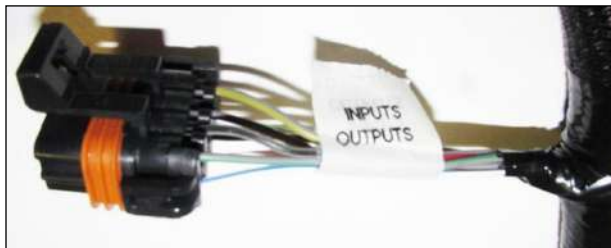

Figure 32

13.0 TRANSMISSION HARNESS

13.1 Transmission Wiring

The transmission harness can be used on 4L60E, 4L65E, early 4L70E, 4L80E, and 4L85E transmissions. Each connector should be labeled.

Transmission ECU Connector (J4) – Plugs into the ECU. Plugs into the last connector opposite the main harness.

Main Transmission Connector – Simply plugs into the connector on the transmission. Located on the driver's side of a 4L80E (installed horizontally) and the passenger side on a 4L60E (installed vertically).

Vehicle Speed Sensor (VSS)/Transmission Output Speed Sensor (OSS) – Located on the rear drivers side on a 4L80E and the rear passengers side on a 4L60E

Turbine Speed Sensor – The 4L60E does not have a turbine speed sensor. It is located towards the front driver's side on a 4L80E. Note that a 4L70E has one internally wired, but is not connected to the Holley harness. The turbine speed sensor is not used for any calculations in the ECU, just for monitoring purposes.

Brake Switch (Grey) – Wired to the brake light switch. This must be installed to a +12v source (as most brake light switches are). This input is used to unlock the torque converter when the brakes are applied.

Ground (Black) – Connect to a good chassis/engine ground source

Power (Red) – Supplies power to the transmission solenoids. This should be connected directly to the battery, or a constant battery source capable of supplying 5 amps.

Switched Power (Red/White) – This should be connected to a +12v switched power source and is used to trigger the relay

NOTE: The power supplying this wire must **NOT** be tied to the same point that the ECU switched power wire (red/white wire) is connected to. If they are tied together, the transmission power could back-feed power to the ECU and the ECU/engine will not shut off when the key is turned off. Use a relay or separate switched ignition power pickup point to supply power to the transmission harness.

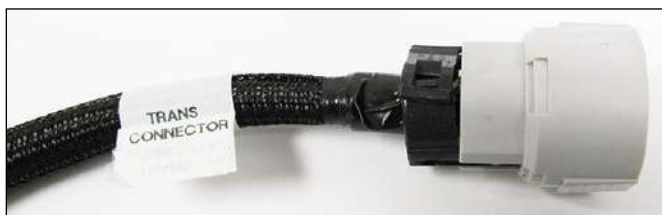

Figure 33 - Main Transmission Connector



Figure 34 - Vehicle Speed Sensor



Figure 35 - Turbine Speed Sensor



Figure 36 - Transmission & ECU Connector



Figure 37 - Loose Wire Bundle

14.0 DRIVE-BY-WIRE HARNESS

14.1 Overview

The Terminator X Max ECU has built-in capability to control OEM type Drive-By-Wire throttle pedals and throttle bodies for aftermarket installation.

To ensure a safe and reliable installation, there are certain hardware requirements that **must** be followed:

See Appendix 3.0 in the full Terminator X instruction manual found for a listing of factory drive-by-wire throttle bodies and pedals that have been pre-calibrated and approved for use with this harness

14.2 Warnings!

Use only the drive-by-wire wiring harness supplied by Holley. THIS HARNESS CAN NOT BE CUT, SHORTENED, LENGTHENED, TAILORED, OR MODIFIED UNDER ANY CIRCUMSTANCE! THE HARNESS CONTAINS PROTECTIVE SHIELDING / GROUNDED CABLING TO ENSURE PROPER OPERATION. DO NOT REMOVE OR MODIFY THE PROTECTIVE SHEATHING UNDER ANY CIRCUMSTANCES. HOLLEY ASSUMES NO LIABILITY FOR ANY INSTANCES ARISING DUE TO USE OF THROTTLE PEDALS, THROTTLE BODIES OR ASSOCIATED COMPONENTS NOT SPECIFICALLY APPROVED BY HOLLEY.

14.3 Installation

Installation of both the drive-by-wire throttle body and pedal assembly should be performed by a professional, competent mechanic. It is important that the installation of both the throttle body and pedal assembly on an engine (not originally equipped with these components) be done in such a manner that assures proper operation of both components as intended by the OEM manufacturer.

- The throttle body must be installed in such a manner that the throttle plate(s) are allowed to rotate freely.
- The pedal assembly must also be installed in such a manner that it is rigidly and securely mounted, yet does not put the pedal in a bind, or put any mechanical stress on the electrical and electronic components. Proper positioning of the pedal is of the utmost importance.
- The accelerator pedal must have adequate clearance throughout the range of its travel to prevent the possibility of the pedal coming in contact with any item that may cause it not to return to the "idle" position upon release. The accelerator pedal must also be mounted far enough away from the brake pedal as to allow for the vehicle's brakes to be fully applied without the operator's foot coming in contact with the D-B-W pedal.
- The drive-by-wire pedal should be in a position such that it is lower than the brake pedal when the brake pedal is depressed.
- Installation of the wiring harness supplied by Holley must be done so that there is no chance the wiring may be cut or abraded. Rubber grommets should be utilized wherever the harness passes thru a firewall / sheet metal panel.
- The DBW harness should never be routed in such a manner that it may come in contact with "noisy" electrical components or wiring that may emit RFI and/or EMI noise. Typical "noisy" components and associated wiring in a vehicle would be spark plug wires, ignition coils, high energy ignition boxes, two-way radios (including CB's), etc. Maintain a minimum of 5" of clearance to any of these types of components.

The harness is designed to be "plug-and-play" with the throttle bodies and pedal assembly indicated above. It should not be used for any other applications.

14.4 System Safeties

Holley designed the drive-by-wire system to utilize a brake pedal switch input. This is wired to a +12v input from the brake pedal switch. If the brake pedal is depressed enough to activate the brake light switch, the following occurs:

- The ECU will not allow a throttle position over 10%, no matter how far the pedal is pushed. This consequently limits the opening of the throttle body.

Before a pedal value over 10% will be recognized, the following must occur in this order:

- Brake pedal switch must be released
- Pedal position must go below 10%

- Fuel flow is limited to 30 lb./hr. as an additional safety.

IMPORTANT! INSTALLATION OF THIS SAFETY CIRCUIT IS REQUIRED WHEN USING THE DRIVE-BY-WIRE FEATURE! DEFEATING OR NEGLECTING TO INSTALL THIS INPUT IS DONE SO AT THE USERS OWN RISK. THE USER ASSUMES ANY AND ALL LIABILITY FOR ANY DAMAGE, AS A RESULT OF A DRIVE-BY-WIRE MALFUNCTION.

Most drive-by-wire systems are designed so there are two position sensors on both the throttle body and the accelerator pedal assembly. This is done as a failsafe in the event that one of the position sensors should fail. Holley EFI systems require that both sets of sensors are functioning 100% properly. If any sensor moves from its calibrated position, the throttle body is immediately de-powered, forcing it to move to the factory “limp home” position. The “limp home” position is described in detail below. Whenever a fault is detected and the throttle body is de-powered, a fuel flow limit of 30 lb./hr. is also introduced.

14.5 Throttle Body “Limp Home” Position

Factory Drive-By-Wire Throttle Bodies have a “Limp Home” position. This is the position that the throttle body is at when no power is applied. It is typically enough air flow to allow a car to move at a speed of approximately 45 mph. This varies by manufacturer, but is the case with the GM throttle bodies this harness supports.

It should be strongly noted that this position allows MORE airflow than the engine uses for an idle position. If the throttle body goes into a “limp home” position due to a sensor failure or other reason, the engine will have more air and result in more power. This will require more brake pressure to be applied if a vehicle is in gear so that it does not move.

14.6 Drive-By-Wire DO’S and DON’TS

DO

- Use only the Holley supplied harness.
- Have the pedal, throttle body, and harness installed by a competent professional.

DON’T

- Do not use wire other than the Holley supplied harness.
- Do not cut, shorten, lengthen, or otherwise modify the drive-by-wire harness for any reason!
- Do not run drive-by-wire harness past high voltage or “noisy” sources
- Do not use this system if the pedal is not securely mounted as described in the instructions above. It must be SOLIDLY mounted with adequate room for safe and proper operation.
- Do not use this system if the throttle body is not properly mounted or has any potential of interference/binding of the throttle plates.
- Do not start the engine unless everything is operating properly.

14.7 Wiring

LS Engines came with two styles of connectors for their DBW throttle bodies; An 8 pin connector (early truck) and a 6 pin (passenger car and 2007+ truck) Appendix 3 of the full Terminator X instruction manual found contains more details and Holley supported part numbers for throttle bodies and throttle pedals and their associated harness part numbers.

ECU connector – plug into location J3 (See Section 10.1 – ECU pic)

Pedal Connector – plug into the throttle pedal

Throttle Body Connector – plug into the DBW throttle body.

Brake Switch Wire – This **MUST** be connected to a +12v input from the brake pedal switch.



Figure 38

15.0 PREVIOUS INSTALLATION REQUIRED

Once all harnessing has been connected, you may plug in the main power harness (referenced in section 9.1) to the ECU.

At this point, the installation of your EFI system should be 100 percent complete. The ECU, TERMINATOR X™ Handheld controller, throttle body and intake hardware, all sensors, wiring, fuel pump, regulator and return line, and all other hardware should be installed. The vehicle should be ready to start and run. If this is not the case, refer to the hardware installation manual included with your particular system.

16.0 TERMINATOR™ INSTRUCTIONS AND TUNING

The TERMINATOR X™ EFI systems are designed to be easy to use for the first time EFI tuner. The instructions are set up in that manner as well. These instructions will not get into detail about EFI theory and operation. They will provide the steps necessary to get you up and running quickly. The TERMINATOR X™ system allows for the user to perform some basic changes to the tuning *if they desire to do so*. The instructions are sequenced to get you up and running so you can enjoy your vehicle, then review some of the parameters that can be adjusted to fine tune your vehicle at a later time if desired.

17.0 INITIAL POWER-UP

Turn the ignition key to the “run” position. This should apply power to the ECU as well as the TERMINATOR X™ Handheld control module. The handheld should power up and the Home Screen (**Figure 39**) should appear.

The Home screen contains icons which will navigate to different functional features of the 3.5 Touch Screen. These features will be discussed in detail throughout this manual.



Figure 39 – Home Screen

NOTE: DO NOT ATTEMPT TO START THE VEHICLE UNTIL YOU ARE TOLD TO DO SO IN THE INSTRUCTIONS BELOW.

NOTE: The handheld has a SD memory card installed in the side. This card contains specific information that is required for the use of the TERMINATOR X™ product. DO NOT replace this card with another. There should be no need to remove this card for normal use.

18.0 HANDHELD NAVIGATION & USE

The 3.5” handheld utilizes a touch screen display. All navigation is done through “touching” an icon or button on the screen. The following is an overview of the different types of adjustment screens that are used in the display, and that may be utilized when tuning or making selections.

18.1 Making Adjustments

Slider Bar: Slide the bar left or right with the stylus, or use the right and left arrow keys for fine adjustment (**Figure 40**).

List: Use the scroll bar on the right hand side of the screen to view all list entries. Touch the desired list item and click ‘OK’ to make a selection (**Figure 41**).



Figure 40 – Slider Bar

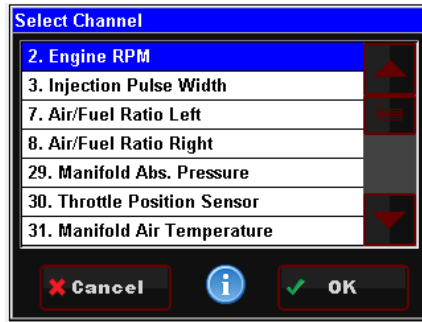

Figure 41 – List

Radio Button: Touch the desired list item to select it (Figure 42).

On Screen Prompts: Follow the on screen text and use buttons at the bottom of the screen to continue or confirm (Figure 43).



Figure 42 – On Screen Prompts

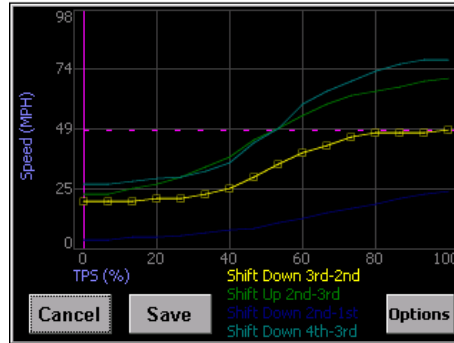

Figure 43 – Graph

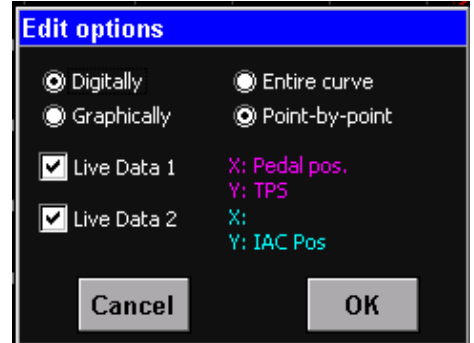

Figure 44 – Edit Options

Digitally: Selecting this option enables slider bar adjustment of individual data points on the graph or the entire curve.

Graphically: Selecting this option enables single point or whole curve adjustment. A stylus may be used to select and drag data on the graph screen.

Entire Curve: Selecting this will 'lock' all the data points together allowing the entire curve to be shifted up or down

Point by Point: Selecting this will allow point by point curve adjustment for fine tuning.

Live Data 1 & 2: This will enable live telemetry on the graph screen making fine tuning easier.

19.0 HOME SCREEN

The HOME SCREEN has 6 selections (Figure 45). They are explained in more detail later in the instructions.

TUNING – Allows for various parameters to be easily adjusted.

MONITOR – A variety of gauge and dash displays.

ADVANCED FEATURES – Advanced / Power Adder tuning

LOGGING – Start, Stop, and Configure Data Logs

FILE – Saves and loads calibrations. Also shows information about the ECU and handheld controller.

WIZARDS – Creates a base calibration and performs the TPS Autaset function.

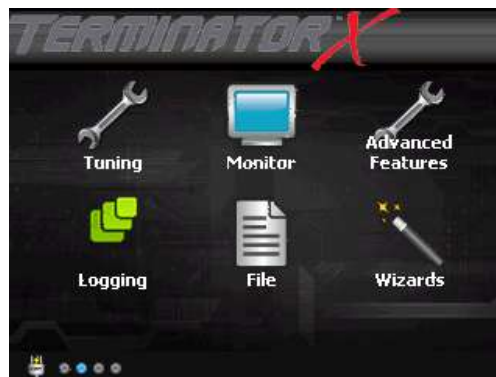

Figure 45

20.0 CALIBRATION WIZARD



The Terminator X system will build a custom calibration for your engine based on a few easy to answer questions. To begin, Choose the Wizards icon from the main menu.



Choose the GCF Wizard icon

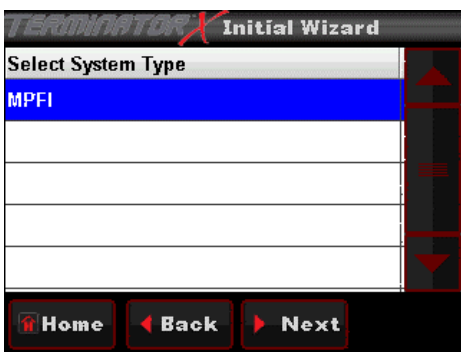

Choose MPFI (Multi Port Fuel Injection) as the system type

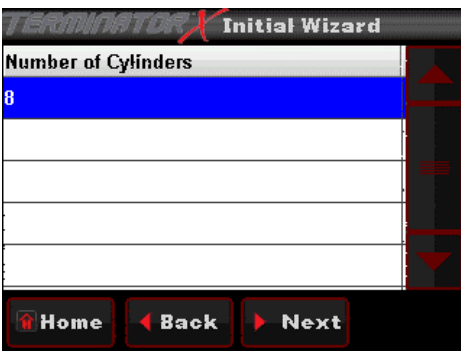

Choose the number of cylinders

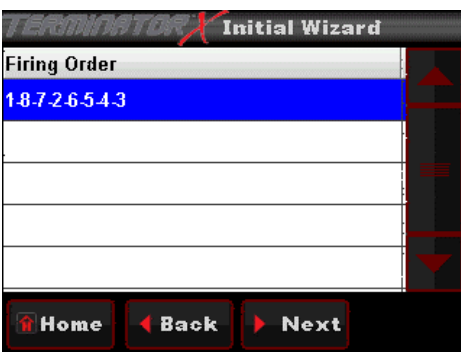

Choose the correct firing order

Tip: All LS engines share the same firing order of 1-8-7-2-6-5-4-3

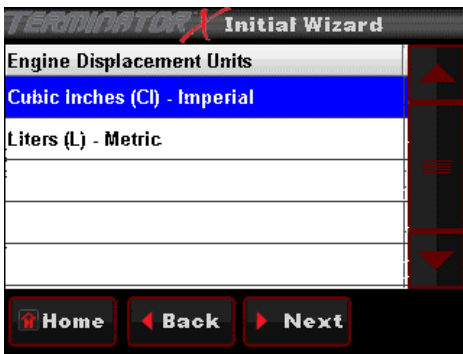

Choose the unit of measure you would like to use to enter the engine size



Use the slider bar to enter your engine size



Use the slider bar to set your desired HOT idle speed

Tip: The Terminator X system will target this idle speed when coolant temp is above 160° F

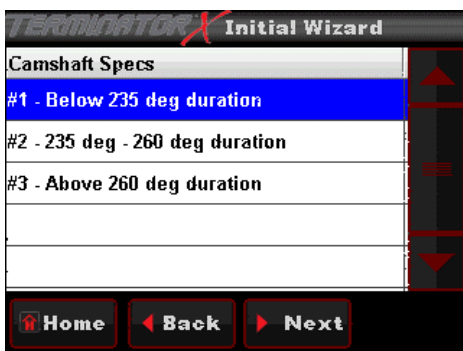

Make a selection that matches the cam specs of your engine.

Tip: If you do not know your exact camshaft specs, choose selection #1

Tip: Closed Loop operation is disabled below 2500 RPM when #3 is chosen. This can be modified per your needs via the included 3.5" handheld

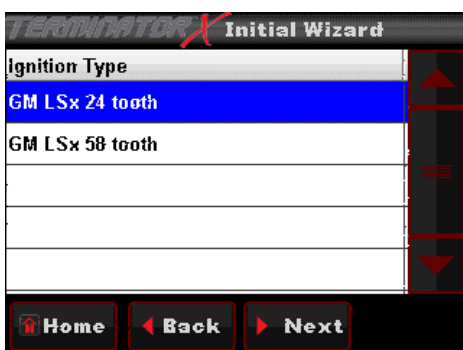

Choose your crank sensor type

Tip: The kit & engine harness you purchased must match your application. For help identifying crank sensor types, visit Appendix 2.0 in the full Instruction manual found.

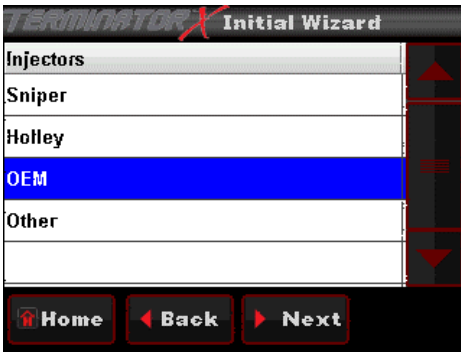

Choose your brand/manufacturer of injector.

Each grouping contains a list of part numbers that are supported with the Terminator X system.

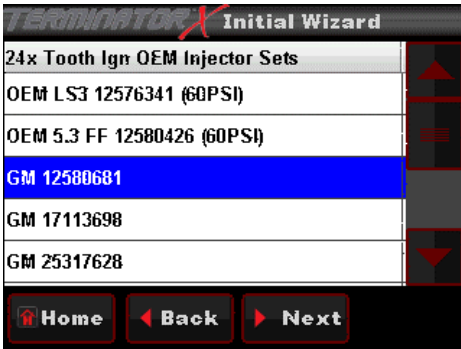

Choose the part number of injector that matches what is installed in your engine.

Tip: For proper operation, it is critical that the correct injector part number is selected

Tip: Injector data can be entered and modified via Terminator X software if your injectors are not listed.

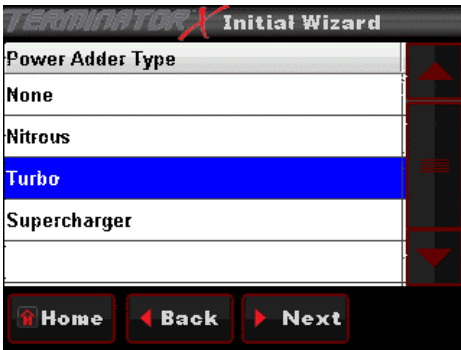

Choose your power adder type

Tip: Users selecting naturally aspirated or nitrous during this step will skip to "Choose throttle body type" on the next page.

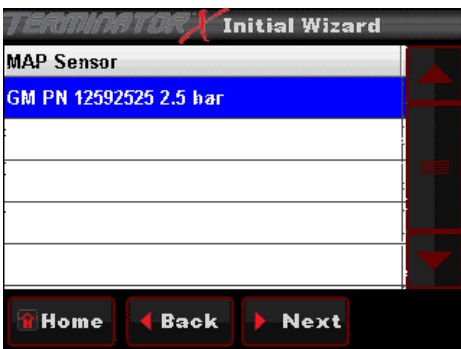

If you selected Turbo or Supercharger in the previous step, select the appropriate MAP sensor

Tip: Terminator X base calibrations require using the GM (or parts store equivalent) 2.5 bar MAP sensor shown here. Failure to do so may cause severe engine damage.

Tip: MAP sensors other than the 2.5 bar GM may be configured via Terminator X software.



If a Turbo or Supercharger was chosen, use the slider bar to set desired wide open throttle (WOT) ignition timing **AT ZERO BOOST**

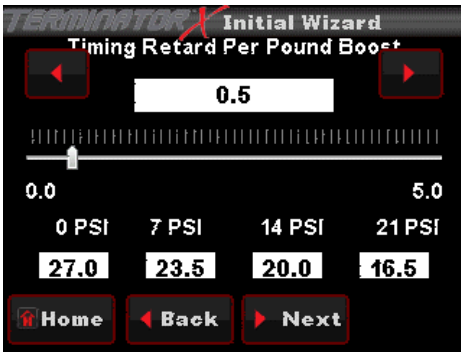

If a Turbo or Supercharger was chosen, use the slider bar to set desired timing retard per pound of boost.

Breakpoints of 7, 14 & 21 PSI are shown for reference



If a Turbo or Supercharger was chosen, use the slider bar to set desired wide open throttle (WOT) Air/Fuel Ratio (AFR) **AT ZERO BOOST**



If a Turbo or Supercharger was chosen, use the slider bar to set desired AFR offset per 7 pounds of boost.

Breakpoints of 7, 14 & 21 PSI are shown for reference



Choose throttle body type (Terminator X Max only)

Select No if you are using a cable operated throttle body

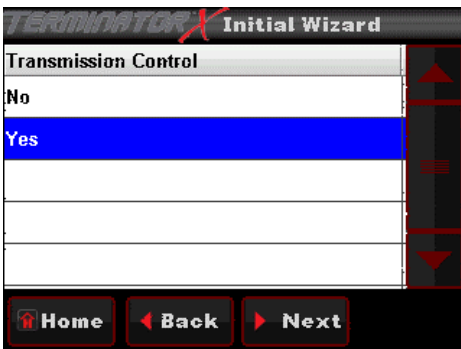

If you will be using the Terminator X system to control an electronic transmission (Terminator X Max only), choose Yes.

Choose no if you have an older non-electronic transmission (i.e. TH350, TH400, 700R-4, etc.) OR if you are using a separate standalone controller for your previously installed electronic transmission.



If transmission control was chosen in the previous step, Select the transmission type you will be controlling



Enter your tire diameter



Enter your gear ratio

Tip: Tire diameter and gear ratio must be entered correctly for proper transmission operation

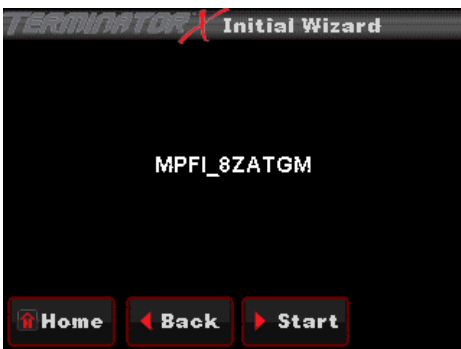

Select the Start button to upload the custom Terminator X calibration to your ECU.

Congratulations, you have completed the setup Wizard!

It is now time to perform a TPS Autaset

21.0 TPS AUTOSET

After completing the calibration wizard, the next step is to perform a "TPS Autaset". **This must be done on a brand new system otherwise the injectors and ignition will not be fired by the ECU.** A TPS Autaset programs the ECU with the full travel/voltage range from idle to wide open throttle for the Throttle Position Sensor (TPS). This must be done with the vehicle ignition power on. The TPS Autaset function is found under the "WIZARDS" choice under the HOME SCREEN. Select "START TPS AUTOSET". Follow the prompts. You can select "Home" at any point to stop the process. If everything is successful, you will see a TPS Autaset Successful message.



Step 1: Select TPS Autoset

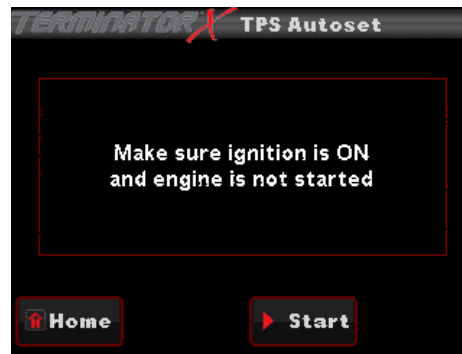

Step 2



Step 3



Step 4: Select 'Done'

22.0 SENSOR VERIFICATION

Before starting the vehicle, verify that all of the sensors are reading properly. Turn the key off, and cycle it back on. At this time you should hear the fuel pump come on and run for 5 seconds. Check for fuel leaks.

On the HOME SCREEN, select the MONITOR tab. This will bring up various options. Select the "Monitors" screen. You will see a screen called "Initial Startup". Select this. With the key on and the engine off, these sensors should read as follows:

- **Engine RPM** – Will show "Stall" when not cranking. Will show RPM once the engine is cranking or running
- **MAP** (Manifold Air Pressure Sensor) – Should read from 95-102. At high elevations it could read as low as 75.
- **TPS** (Throttle Position Sensor) – Slowly depress the throttle to wide open. It should read 100 at wide open throttle. Cable operated throttle bodies should read 0 closed.
- **CTS** (Coolant Temperature Sensor) – reads engine temperature. If the engine is "cold", it should read close to ambient temperature.
- **Battery** – Will read battery voltage. Should be 12.0 volts minimum.

If ANY of these sensors are not reading properly DO NOT attempt to start the engine.

23.0 STARTUP

The vehicle should be ready to be started. Open the same sensors screen as in section 23.0. Make sure the TPS is reading 0. If it does not, do a TPS AUTOSET, or if it is reading 1-2%, close the idle screw on the throttle body slightly.

Crank the engine and look at the RPM parameter. It should change to "Syncing", indicating the ECU is syncing with the RPM signal for an instant, then show an RPM signal. The engine should fire and run and come to an idle.

If you do not get an RPM signal, there is an error in the wiring or system setup. Call Holley Tech service for advice.

If the engine starts but is idling too low and appears to be struggling for air, refer to section 26.0 for cable operated throttle bodies and section 31.6 for drive-by-wire.

24.0 AFTER-STARTUP

Once the vehicle has started, look for any fuel or coolant leaks. Let the vehicle warm up and look at some other parameters to make everything is operating properly. Go into the MONITOR, MONITORS, and select the “Closed Loop” icon.

- **Closed Loop Status** – Indicates whether the engine is “Closed Loop” or “Open Loop”. Closed Loop indicates that the ECU is adding or subtracting fuel to maintain the target air/fuel ratio. The TERMINATOR™ calibrations are such that the system should be operating closed loop almost all of the time.
- **Closed Loop Compensation** – This is the percentage of fuel that the ECU is adding or subtracting to maintain the target air/fuel ratio at any specific moment. A value with a minus (-) sign in front indicates the ECU is removing fuel. A value with no minus sign indicates the ECU is adding fuel. When in open loop operation, this will always stay at 0%.
- **Target Air/Fuel Ratio** – This is the target AFR (air/fuel ratio) the ECU is trying to maintain. This will vary depending on the engine speed and load.
- **Air/Fuel Ratio Left** – This will show the air/fuel ratio the wideband oxygen sensor is reading. The Closed Loop Compensation should be adding or subtracting fuel all the time such that the AFR Left should always be close to the Target AFR value. (Note ARF Right will only be active if a second sensor is being used which is not included).
- **Fuel Learn Status** – This indicates the status of the TERMINATOR™ “Self Tuning” operation (Learn Status). The system will automatically tune itself as you drive around. There are several conditions that must occur in order for the Self Tuning to occur. The engine temperature must exceed 160° F. The system must be operating in a closed loop mode, and the Self Tuning must be enabled. The base TERMINATOR™ setups have the Self Tuning enabled. Once the engine reaches 160° F, the Self Tuning should be active. The Learn Stat will show “NoLearn” when Self Tuning is not active and “Learn” if Self-tuning is active.

If any of these parameters are not showing a proper value, find out why before further driving the vehicle.

25.0 IDLE SETTING/CABLE OPERATED THROTTLE PLATE SETTING

Once the engine is up to operating temperature, the idle speed can be set to what is desired.

From the HOME SCREEN, select the TUNING tab. Then select the BASIC and then BASIC IDLE. You can see what the target hot idle speed is set to. If you are happy with the current value, use the BACK or HOME button to exit. If you would like to change it, click on the IDLE SPEED. This brings up a screen to adjust the idle speed (Figure 46). Move the button left and right to adjust it. Click the button to save the new value or select CANCEL at the bottom to move out of this screen.

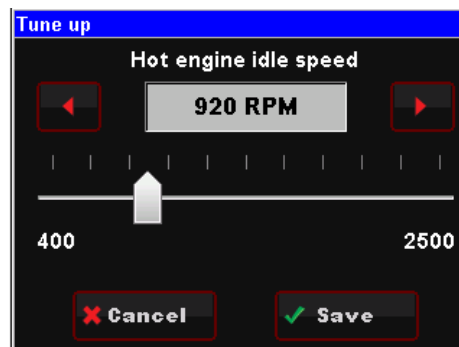

Figure 46

Whether you change the target idle or not, you need to set the throttle plates on the throttle body to an optimal position. To do so, with the engine running select the MONITOR tab. You will see the IDLE screen. Look at the “IAC Position” value. This value should be set between 2 and 10 with the engine in neutral and up to operating temperature. Also make sure the “TPS” value is showing a value of 0. If it is not, you need to perform a TPS AUTOSET.

If the “IAC Position” value is showing zero, you must close the throttle plates until it reads a value of 2-10. Slowly turn the throttle shaft adjustment screw on the throttle body out (counter-clockwise). If the IAC position is “stuck” at 0, it is likely that the engine is idling at a higher speed than you have set the target idle speed for. You need to adjust the throttle plates to resolve this issue.

If the “IAC Position” value is greater than 10, it is a good idea to open (turn the throttle shaft adjustment screw in, clockwise) the throttle plates until the “IAC Position” value is between 2 and 10. Note that if you open the throttle plates such that the “TPS” position goes above a value of 0, you will need to shut the vehicle off and perform a TPS AUTOSET. Then restart the vehicle and continue adjusting the throttle plates. Once the TPS goes above a value of 0, the ECU goes out of its “idle” mode and will lock the IAC Position to a fixed value.

When the adjustments are completed, make sure the TPS reads a value of 0 with the engine idling.

26.0 SELF-TUNING

At this point, it is time to just drive the vehicle and let the system perform its self-tuning process. The best way for this is to drive the vehicle under as many different operating conditions as possible. Different engine speeds and loads. Start by slowly revving the engine up in neutral and holding it at different speeds up to 2500 RPM. This will help the system learn these points. Then drive the vehicle, possibly using different transmission gears to learn in different areas. If you have an automatic transmission you may want to put it in gear, and with your foot on the brake pedal, apply a SMALL amount of throttle so that the system learns in this area as well.

NOTE: There are several conditions where Learning will NOT occur. They are the following:

- If the engine is below 160° F
- When the engine sees quick accelerator pedal movement
- Certain times when the accelerator pedal is lifted and the vehicle is coasting
- If the learn is disabled by the user

If you are interested in seeing if Self Tuning is completed in a certain area, you can look at the following:

- Select MONITORS from the HOME SCREEN
- Select the LEARN icon
- The FUEL LEARN STATUS indicates if the learn feature is active. The FUEL LEARN PERCENT indicates what the learn value is.
- Look at the CLOSED LOOP COMPENSATION value. Once this value is close to zero, learning is complete in an area.

At this point you can drive and enjoy your TERMINATOR X™ EFI as it is. The full instruction and tuning manual can be found on the product pages and describes in detail how you can adjust various parameters to further optimize fuel economy and overall performance, if desired.

TERMINATOR[™]X

TERMINATOR[™]X MAX

MPFI FUEL INJECTION SYSTEM



PART NUMBERS

550-903 thru 905, 550-916 thru 918 & 550-926 thru 931

HANDHELD TUNING AND REFERENCE MANUAL – 199R11761

TUNING

BASIC

The TERMINATOR X handheld allows the user to perform tuning changes to help optimize mileage, drivability, and performance. The tuning is split up into “Basic Tuning” and “Advanced Tuning” sections.

BASIC FUEL

Allows changes to the Target Air/Fuel ratio at idle, cruise, and wide open throttle. The following are typical values and tuning notes.

TARGET AFR

TARGET AFR AT IDLE

Typically between 13.5 and 15.0. Engines with larger cams may need a richer setting for smoothest idle.

TARGET AFR AT CRUISE

Typically between 13.5 and 15.5. Engines with larger cams may need a richer setting.

TARGET AFR AT WOT

Typically between 12.5 and 13.2 on Naturally Aspirated engines. Running richer may reduce power. Running leaner may reduce power or cause potential engine damage.

TARGET AFR BOOST OFFSET

Use the slider bar to input the desired target AFR Offset per 7 lbs of boost.

ACCELERATION ENRICHMENT

ACCELERATION ENRICHMENT

Changes the “accelerator pump” function of the fuel injection. Raising the number increases the amount of fuel added when the pedal is pushed. Lowering the number decreases the amount of fuel added when the pedal is pushed. It is highly recommended NOT to change this until the ECU is allowed to perform self-tuning.

FUEL PRIME

FUEL PRIME ENABLE

Fuel prime is an option that is enabled by default in all of the base calibrations. The fuel prime function injects a small shot of fuel into the intake runners when the ignition is turned on, allowing the engine to start much quicker. The amount of fuel is based on the engine temperature and how long it was since the engine previously ran. This amount of fuel can be increased or decreased by changing the “Percent” value. If the engine seems flooded reduce this value, if the engine seems to want more fuel, increase it. Experiment for best results. Typically this value will range from 75-150% with a maximum of 200% typically used

NOTE: THE ECU ONLY INJECTS FUEL ONCE AT KEY-ON, AND WILL NOT DO IT AGAIN UNTIL THE ENGINE HAS RUN. THIS FUEL PRIME OCCURS ½ OF A SECOND AFTER KEY-ON. IF YOU QUICKLY TURN THE IGNITION KEY WITHOUT WAITING FOR ½ A SECOND, THE PRIME WILL NOT OCCUR AND IT MAY TAKE LONGER FOR THE ENGINE TO START.

FUEL PRIME PERCENT

If the engine seems flooded reduce this value, if the engine seems to want more fuel, increase it. Experiment for best results. Typically this value will range from 75-150% with a maximum of 200%.

CLOSED LOOP / LEARN

CLOSED LOOP

CLOSED LOOP ENABLE/DISABLE

This menu enables or disables closed loop operation. There is typically no reason to turn off closed loop operation unless you suspect an oxygen sensor problem and want to disable the sensor.

NOTE: SELF-TUNING REQUIRES CLOSED LOOP OPERATION TO FUNCTION.

MIN CTS ENABLED

Enable or disable the minimum coolant temp for closed loop operation.

COOLANT TEMP

Once enabled, use this to set the minimum coolant temp for closed loop operation.

TRANSFER TABLE

This will transfer data from the Learn Map to the Base Fuel map.

FUEL LEARN

FUEL LEARN ENABLE/DISABLE

The LEARN Enable / Disable menu turns the Self Tuning "On" and "Off". If enabled, self-tuning is performed. Learning should be enabled when an engine is first run with the Terminator X and the tuning process is occurring. After the vehicle is driven under various operating conditions, and is running well, it is advised to limit the amount of learning that can occur to 10% or less in the Advanced Learn menu.

BASIC IDLE

Selecting BASIC IDLE allows you to change the Target Hot Engine Idle Speed. This should be adjusted to your desired idle RPM. Values between 650-800 rpm are typical. Larger camshafts or aftermarket torque converters may require a slightly higher value to maintain proper idle quality while in gear.

HOT ENGINE IDLE SPEED

This will adjust the target HOT (above 160°F) idle speed.

SPARK

IGNITION TIMING AT IDLE

8-22 degrees is typically used at idle. The larger the camshaft, the more timing is usually used.

IGNITION TIMING AT CRUISE

32-44 degrees is typically used when cruising for optimal fuel economy.

IGNITION TIMING AT WOT

Varies by engine, but typically values range between 25 and 34 for Naturally Aspirated engines.

CRANKING IGNITION TIMING

This is the actual timing during cranking. It is set to 15 degrees at any RPM below 400 by default.

DRIVE-BY-WIRE

The Pedal vs. Throttle Position table is the primary method of “tuning” a Drive-By-Wire throttle body system. The “Pedal Position” represents the position of the accelerator pedal. The user can adjust the “Throttle Position” to change based on the pedal position. This allows the user to increase or decrease throttle body position (engine airflow) to tailor the “responsiveness” of the engine. It can allow for an overly-large throttle body to have good driving manners or a small throttle body to be very responsive.

On new installations, Idle Tuning must be performed on the “Pedal vs. Throttle” table. It is a similar adjustment to opening or closing the throttle plates with the idle set screw on a standard cable driven throttle body.

TAKE CARE WHEN TUNING THE “PEDAL VS. THROTTLE” TABLE. WHEN YOU INCREASE THE PEDAL POSITION VALUE AT A CERTAIN TPS VOLTAGE, THE THROTTLE WILL GO TO THAT POSITION AT THAT TPS VOLTAGE SETTING. IT IS EXTREMELY IMPORTANT THAT YOU PAY CLOSE ATTENTION AND ARE NOT DISTRACTED WHEN MAKING CHANGES TO THE “PEDAL VS. THROTTLE CABLE” CURVE WITH THE TOUCH SCREEN. ANY CHANGES TO THIS CURVE SHOULD BE MADE WITH THE SYSTEM OFFLINE AND NOT WHILE THE ENGINE IS RUNNING AND ONLINE. THE CURVE OF THIS GRAPH SHOULD ALWAYS BE LOW AT LOW (IDLE) PEDAL POSITION AND INCREASE TO FULLY OPEN AT HIGH PEDAL POSITIONS. IF YOU DO NOT FULLY UNDERSTAND THIS GRAPH, DO NOT ATTEMPT TO MAKE ANY CHANGES TO THE SYSTEM. LOCATE A KNOWLEDGEABLE INSTALLER/TUNER OR CONTACT HOLLEY PERFORMANCE TECHNICAL SERVICE FOR ASSISTANCE. THE FIRST DATA POINT IN THIS TABLE IS LIMITED TO A VALUE OF 20%, THE SECOND CELL 30%, AND THE FOURTH CELL 40%. ALL OTHER CELLS ALLOW FOR THE THROTTLE BODY TO BE COMMANDED TO 100% THROTTLE BODY OPENING.

PEDAL VS THROTTLE

Once the engine is warm and idling in neutral, refer to the “IAC Position” value in the data monitor. You want this value to read between 5-15%. If it reads higher, turn the engine off and increase the first cell value (Pedal Position = 0%) in 1% increments until the IAC is in the 5-15% range. If the IAC position is at 0%, follow the same procedure but lower the first cell value until the IAC reads 5-15%.

WARNING: ENGINE MUST BE TURNED OFF BEFORE MODIFYING THE PEDAL VS THROTTLE TABLE!

TRANSMISSION

CAUTION MUST BE USED WHEN MODIFYING TRANSMISSION PARAMETERS. LOWERING LINE PRESSURES TOO MUCH CAN CAUSE RAPID WEAR AND DAMAGE TO THE TRANSMISSION. THE BASE CALIBRATIONS PROVIDED SHOULD PROVIDE A SAFE BASE CALIBRATION. IF THE TRANSMISSION HAS VERY SOFT SHIFTS OR SEEMS TO SLIP, IMMEDIATELY STOP TO DIAGNOSE WHETHER THE PROBLEM IS DUE TO TUNING OR MECHANICAL ISSUES.

SHIFTS

Each Up-shift and Down-shift can be completely configured by selecting ‘Shifts’ from the transmission menu.

All Upshift points must occur at a higher speed than downshift. The touchscreen will give a warning and not allow this to occur if requested.

Although it can be programmed with the handheld, the ECU won’t allow a downshift to occur if it will over-rev the past the MAXIMUM RPM in the SYSTEM>TRANSMISSION>TRANS SETUP area.

SHIFT UP 1ST-2ND

Table used to modify 1-2 upshift based on throttle position (or MAP for boosted applications) and speed.

SHIFT DOWN 2ND-1ST

Table used to modify 1-2 downshift based on throttle position (or MAP for boosted applications) and speed.

SHIFT UP 2ND-3RD

Table used to modify 2-3 upshift based on throttle position (or MAP for boosted applications) and speed.

SHIFT DOWN 3RD-2ND

Table used to modify 3-2 downshift based on throttle position (or MAP for boosted applications) and speed.

SHIFT UP 3RD-4TH

Table used to modify 3-4 upshift based on throttle position (or MAP for boosted applications) and speed.

SHIFT DOWN 4TH-3RD

Table used to modify 4-3 downshift based on throttle position (or MAP for boosted applications) and speed.

WOT SHIFTS

Use this menu to choose the RPM at which the transmission will upshift at WOT. Each gear change may be adjusted independent of the others.

1-2 WOT UPSHIFT

This is the RPM at which the 1-2 upshift will occur.

2-3 WOT UPSHIFT

This is the RPM at which the 1-2 upshift will occur.

3-4 WOT UPSHIFT

This is the RPM at which the 1-2 upshift will occur.

TORQUE CONVERTER CLUTCH (TCC) PARAMS

Contains parameters that tune TCC activation and deactivation.

THE TCC WILL NOT APPLY UNTIL THE ENGINE IS ABOVE 122°F, AS WELL AS A TRANSMISSION FLUID TEMPERATURE ABOVE 46°F.

MINIMUM RPM TO ENABLE TCC

This is the minimum RPM at which the Torque Converter Clutch will enable. This value can be adjusted so that engines with large camshafts do not hesitate surge if the TCC is applied at too low of an engine speed.

RPM TO DISABLE TCC

Used to unlock the TCC once it is locked. The Lock and Unlock values should not be too close together, or they will continuously lock and unlock. Applications with high stall torque converters will typically need 400-700 RPM or more between these values.

MAXIMUM TPS TCC

Throttle position value when the TCC will unlock. Most lockup torque converters do not have a clutch designed to lock up when higher power is being applied. It is best to unlock the converter under moderate to hard acceleration. Typically TPS values should be between 25-50%.

TCC DISABLE

This will disable TCC functionality in all conditions.

TCC (UN)LOCK

These parameters work in addition to the TCC Parameters by offering additional tuning based on vehicle speed. This keeps the TCC from locking up during 'around-town' driving if it is not desired. The Lock values should always be higher than the Unlock values. Adjustments to these can be done by using the graph.

TCC LOCK

This is a table to adjust when the TCC locks based upon throttle position and vehicle speed.

TCC UNLOCK

This is a table to adjust when the TCC unlocks based upon throttle position and vehicle speed.

LINE PRESSURE

Tune the line pressure vs. TPS or MAP for each gear. A lower duty cycle (moving towards 0%) increases line pressure with 0% providing maximum line pressure applied. Values above 40-50% typically result in a line pressure too low for any throttle position, which may result in transmission damage.

Naturally aspirated and nitrous calibrations created through the wizard use TPS for line pressure vs. load scaling, whereas turbo or supercharged calcs use map sensor for line pressure vs load scaling.

LINE PRESSURE 1ST GEAR

Editable line pressure curve for 1st gear

LINE PRESSURE 2ND GEAR

Editable line pressure curve for 2nd gear

LINE PRESSURE 3RD GEAR

Editable line pressure curve for 3rd gear

LINE PRESSURE 4TH GEAR

Editable line pressure curve for 4th gear

NON-ELECTRONIC TRANS

Used for GM TH700R4 transmissions that have a lockup torque converter. Note that this should be used to drive a relay that is used in conjunction with a brake pedal switch disable. The brake pedal switch is not part of the EFI logic for this transmission type.

ENABLE TCC OUTPUT

Creates an output that can be used to trigger the relay used for the torque converter clutch solenoid activation.

TCC OUTPUT

Allows the user to select an available output pin.

NOTE: THIS OUTPUT IS USED TO TRIGGER A RELAY. THE ECU OUTPUT TRIGGER WIRE SHOULD NEVER BE DIRECTLY CONNECTED TO THE TCC SOLENOID.

See THE "INPUT & OUTPUTS" SECTION for more information on the input and outputs.

MIN TPS FOR LOCKUP

TPS positions below this parameter will unlock the torque converter.

MIN RPM FOR LOCKUP

Converter will not lock unless engine speed is above this value.

MIN CTS FOR LOCKUP

Converter will not lock unless Engine Coolant Temperature is above this value.

WOT UNLOCK TPS

If enabled, converter will unlock above this TPS.

SYSTEM

OUTPUTS

FAN #1 ON TEMPERATURE

The OUTPUT screen allows for the Fan #1 and Fan #2 ON and OFF temperatures to be adjusted. The ON temp needs to always be a higher value than the OFF temp. Use a difference of at least 5 degrees so they aren't cycling excessively. In Sniper Kits, these are ground outputs that should be wired to trigger a fan relay. NEVER wire them directly to the fans!

Preset to 195°F

FAN #1 OFF TEMPERATURE

Preset to 180°F.

FAN #2 ON TEMPERATURE

Preset to 205°F.

FAN #2 OFF TEMPERATURE

Preset to 190°F.

AC SHUTDOWN MAX TPS

The AC Disable value is a TPS value above which a ground output is sent out to deactivate the air conditioning compressor at wide open throttle Preset to 50%.

ENGINE SETUP

ENGINE DISPLACEMENT

This value should reflect your actual engine size. The base fuel table calculates proper fuel flow based upon this value.

FUEL SETUP

FUEL PUMP PRIME

This is how long the fuel pump will run for when the ignition is first turned on to pressurize the system and there is no rpm signal.

CLEAR FLOOD TPS

Above this value, no fuel will be injected when the engine is cranking/starting. Typically set to 65% or higher.

RATED FLOW PER INJECTOR

Fuel Injector flow in lb/hr

RATED INJECTOR FUEL PRESSURE

Pressure at which injectors flow was rated at (psi)

NOTE: DO NOT CONFUSE THIS VALUE WITH ACTUAL SYSTEM FUEL PRESSURE!

ACTUAL SYSTEM FUEL PRESSURE

This is the actual fuel system pressure of the vehicle. All Terminator X LS base calibrations are configured for 60 psi.

NOTE: INCORRECT ENTRY WILL CAUSE THE FUELING TO BE INACCURATE.

TERMINATOR X SETUP

INJECTION TYPE

Displays the current injection strategy

SYSTEM TYPE

Displays fuel injector information

IGNITION SETUP

IGNITION SETUP #1

IGNITION TYPE

Displays the ignition type information

IGNITION SETUP #2

FIRING ORDER

Displays the engines selected firing order

MAIN REV LIMITER TYPE

View and edit the main rev limiter type. There are five types to choose from:

- Fuel Only – performs a “hard cut” of fuel flow only when the main over-rev HIGH RPM is hit. “Hard cut” means that fuel flow is stopped to all cylinders until the main over-rev LOW RPM setting is met.
- Spark Only – performs a “hard cut” of ignition only when the main over-rev HIGH RPM is hit. “Hard cut” means that ignition is stopped to all cylinders until the main over-rev LOW RPM setting is met.
- Fuel and Spark – performs a “hard cut” of ignition AND fuel flow when the main over-rev high RPM is hit.
- Soft – begins a “soft cut” of ignition when the main over-rev LOW RPM is hit. “Soft cut” means that ignition will be removed from individual cylinders as needed to limit RPM. If the HIGH RPM limit is reached, a hard cut will be implemented.
- Spark, high only – This type has a single high side value. It is recommended to use this for a 2-step rev limiter and as a high side rev limiter.

IT IS USUALLY BEST TO HAVE A NARROW RANGE (20-50 RPM) BETWEEN THE LOW AND HIGH RPM SETTINGS TO REDUCE STRESS ON THE ENGINE.

MAIN REV LIMITER HIGH RPM

See rev limiter types above

MAIN REV LIMITER LOW RPM

See Rev limiter types above

NOT AVAILABLE FOR REV LIMITER TYPE "SPARK, HIGH ONLY"

STATIC TIMING

GET

This gets the commanded static timing value that has been set previously, if user navigated away from static timing check screen and the ignition has not been cycled.

SET

This sets the commanded timing to the chosen value.

CLEAR

This clears the static timing value.

CLOSE

This closes the Static Timing menu.

TRANSMISSION

TRANS SETUP

TRANSMISSION TYPE

Displays the calibration's transmission type

MAXIMUM RPM

If this RPM is exceeded when in manual shift mode, the transmission will upshift automatically. If a manual downshift is performed, and this RPM will be exceeded, the downshift will not be allowed.

SPEED CALC

TIRE DIAMETER

Measure and enter the real tire diameter (inches).

REAR GEAR RATIO

Enter the rear axle gear ratio.

ADVANCED FUEL

STARTUP ENRICHMENT

CRANKING FUEL

This dictates how much fuel is injected when the engine is cranking and is dependent on coolant temperature. Changing this value offsets the entire curve at all temperatures. Adjustment values are in pounds of fuel per hour (PPH) and should initially be adjusted in increments of 2-4 PPH.

AFTER START HOLDOFF

The amount of time after engine starts to when the after start fuel is deployed.

AFTER START ENRICHMENT

The afterstart parameter is fuel that is added for a short time immediately after an engine starts. This value varies depending on engine temperature. Changing this value offsets the entire curve at all temperatures. Adjustments are made as a percentage of the base map from 75% to 200%, 100% would mean no additional fuel is being added, 110% would mean that an additional 10% of fuel is being added to the base fuel map, and 85% would mean that 15% of fuel is being taken away from the base map. All selections will decay back to 100% over a predetermined amount of time.

AFTER START DECAY RATE

The amount of time it takes for the After Start Enrichment to decay to zero.

ACCELERATION ENRICHMENT

AE VS. TPS RATE OF CHANGE

Ads additional, momentary fuel based on the rate of change of the TPS. Same function as an accelerator pump on a carburetor.

AE VS. MAP RATE OF CHANGE

This parameter provides another way of adding fuel when the accelerator is depressed. It adds fuel depending on how fast the MAP sensor reading changes (detects a change in engine load). There is typically no need to adjust this parameter except possibly under some extreme conditions of vehicles that are heavy or under-powered. Adjustment values are in pounds of fuel per hour (PPH) and should initially be adjusted in increments of 5-10 PPH.

AE TPS VS COOLANT TEMP

This curve adjusts the acceleration enrichment as a function of coolant temperature and TPS rate of change. This should not need to be adjusted.

MAP AE TIME VS COOLANT

The length of time it takes for the AE vs. MAP fuel to decay from peak value to 0.

MAP AE VS COOLANT

Modifies the AE vs. MAP Rate of Change Graph based on engine coolant temperature.

TEMPERATURE ENRICHMENT

COOLANT TEMP ENRICHMENT

Coolant enrichment is similar to the choke on a carburetor. Adjustments are made as a percentage of the base map from 100% to 150%. 100% would mean no additional fuel is being added by the Coolant Enrichment, 110% would mean that an additional 10% of fuel is being added to the base fuel map which will decay back to 100% in relation to actual engine coolant temperature.

A/F RATIO OFFSET

A positive value LEANS the target A/F ratio and a negative value RICHENS the target A/F ratio.

AIR TEMP ENRICHMENT

The Air Temperature Enrichment % table is used to add additional fuel based on air temperature. As air gets colder it typically becomes denser, requiring more fuel. This table is beneficial to minimize closed loop correction values.

IDLE FUEL

IDLE FUEL TRIM

This modifies the VE fuel table values in the idle area of the fuel map. It is only available when the "Minimum RPM to enter closed loop" feature has been enabled and configured.

NOTE: BASE CALIBRATIONS MADE THROUGH THE WIZARD THAT USE CAMSHAFT TYPE 3 HAVE CLOSED LOOP DISABLED BELOW 2500 RPM BY DEFAULT.

CLOSED LOOP

CLOSED LOOP #1

CLOSED LOOP ENABLE / DISABLE

This menu enables or disables closed loop operation. There is typically no reason to turn off closed loop operation unless you suspect an oxygen sensor problem and want to disable the sensor.

NOTE: SELF-TUNING REQUIRES CLOSED LOOP OPERATION TO FUNCTION.

CLOSED LOOP + LIMIT

The maximum percentage the ECU is allowed to add to the base fuel calibration in order to maintain the commanded target air fuel ratio. This is set to 50% by default and under most circumstances should not need to be changed.

CLOSED LOOP – LIMIT

The maximum percentage the ECU is allowed to remove from the base fuel calibration in order to maintain the commanded target air fuel ratio. This is set to 50% by default and under most circumstances should not need to be changed.

CLOSED LOOP SPEED

This is the "speed" (gain) at which closed loop operation occurs. This can be set to five levels, 1, 2, 3, 4, or 5. 3 is the base setting and should be good for most applications. 4 or 5 is typically not used as the closed loop speed may be too excessive for certain applications. If the oxygen sensor is installed far back in the exhaust (more than 1 foot back from the collector in long tube headers), a value of 1 or 2 may be needed.

CLOSED LOOP #2

ENABLE RPM TO ENTER CL

Enable or Disable minimum RPM required to enter closed loop operation.

RPM TO ENTER CL

Below the Engine Speed value entered, the engine will not operate closed loop – it will operate open loop.

ENABLE MIN CTS TO ENTER CL

Enable or Disable minimum coolant temperature required to enter closed loop operation.

CTS TO ENTER CL

Below the Engine Coolant Temperature value entered, the engine will not operate closed loop – it will operate open loop.

ENABLE TPS TO ENTER CL

Enable or Disable minimum throttle position required to enter closed loop operation.

TPS TO ENTER CL

Below the Throttle Position value entered, the engine will not operate closed loop – it will operate open loop.

ADV. LEARN

LEARN + LIMIT

This value is set to 100% by default, and should remain there until ample driving time and tuning has occurred. The LEARN COMPENSATION LIMIT is a parameter that ECU is allowed to work within when making changes to the fuel map based upon CLOSED LOOP operation. Unlike the CLOSED LOOP LIMIT which is a set parameter for commanded changes to actual fuel flow based upon the O2 sensor reading, LEARN COMPENSATION LIMITS are the percentage of change that is allowed to actually be saved as a modifier to the fuel map.

LEARN – LIMIT

This value is set to 100% by default, and should remain there until ample driving time and tuning has occurred. The LEARN COMPENSATION LIMIT is a parameter that ECU is allowed to work within when making changes to the fuel map based upon CLOSED LOOP operation. Unlike the CLOSED LOOP LIMIT which is a set parameter for commanded changes to actual fuel flow based upon the O2 sensor reading, LEARN COMPENSATION LIMITS are the percentage of change that is allowed to actually be saved as a modifier to the fuel map.

ENABLE RPM TO ENTER LEARN

Enable or Disable minimum RPM required to enter learn.

RPM TO ENTER LEARN

Below the Engine Speed value entered, the ECU will not populate the learn table.

ENABLE TPS TO ENTER LEARN

Enable or Disable minimum throttle position required to enter learn.

TPS TO ENTER LEARN

Below the Throttle Position value entered, the ECU will not populate the learn table.

ADV. IDLE

Cable Throttle Bodies

The Idle Air Control (IAC) motor is a stepper motor located in the throttle body that controls the idle speed of the engine by metering air. It also operates during engine cranking and when the engine returns back to idle. The IAC moves from a position of 0% (fully closed, no air added) to 100% (fully open, maximum air flow).

Drive-By-Wire Throttle Bodies

Unlike a cable throttle body with separate IAC stepper motor, a DBW throttle body modulates the actual blade position to maintain commanded idle settings.

IAC RAMPDOWN

IAC HOLD POSITION

This is the position the IAC motor will “hold” or “freeze” at when the TPS moves above idle (when TPS becomes greater than 0%). If it is too high, the engine RPM will “hang” and not return to idle.

IAC RAMP DECAY

This is the time (in seconds) it takes for the IAC to return to the target idle range of movement.

IAC RAMP START (RPM ABOVE IDLE)

This value is the RPM added to the target idle speed that the IAC will automatically start to ramp back down to idle. If this is too low, the engine RPM will “hang” and not return to idle.

IAC KICK

The IAC Kick provides a temporary increase in IAC position to keep engine the RPM from dropping. Typically, this is used in conjunction with an A/C system to keep the engine speed from ‘dipping’ as the compressor cycles on and off.

IAC CONTROL

IAC CONTROL

This menu is used to select the type of IAC motor application that is being used. This selection drives the background parameters that control the IAC motor. These parameters have been fine tuned for each of these applications, eliminating the need for the user to perform further modifications.

IAC STARTUP

IAC PARKED POSITION (CRANKING)

This is the position the IAC motor will be at during cranking and immediately after the engine starts. If it is too high, the engine will be at too high of an RPM once it starts – too low and poor starting will result. Note that this is a temperature based table. The percentage value changed in the handheld offsets this entire curve.

IAC STARTUP HOLD TIME

This is the amount of time that the IAC will remain at the “IAC Parked Position”. Lower this if the engine ‘hangs’ at a higher RPM for too long after startup.

IAC STARTUP DECAY TIME

This is the amount of time for the IAC to decay from the “IAC Parked Position” back to its “Target Idle” position. It is a linear decay.

IDLE SPARK

IDLE SPARK ENABLE / DISABLE

Idle spark is a feature active only when the ECU is controlling timing. When enabled, the ECU modifies commanded timing at idle to help maintain the target idle speed.

NOTE: THIS FEATURE SHOULD BE DISABLED WHEN CHECKING BASE TIMING WITH A TIMING LIGHT AND NOT USING THE STATIC TIMING OPTION.

P TERM

Raising or lowering the “P Term” will change the speed at which the timing is allowed to change. Experiment to see what the engine likes best.

D TERM

The “D Term” is used to help minimize overshoot. If you are unsure, just make the D term the same value as the P term to start.

IDLE SPEED

IDLE SPEED CURVE

Unlike the Idle speed slider bar found in the Basic Tuning menu, this allows for full customization of target idle speed at all coolant temperatures

MONITOR

The Terminator X handheld display has a variety of pre-configured gauge screens. Three fully customizable screens are also included. Most channels allow for user-programmable caution and warning limits to provide visual indicators of parameters that are deemed to be out of range.

MONITORS

IDLE

Engine RPM / TPS / IAC Position / Air/Fuel Ratio / Ignition Timing

LEARN

Fuel Learn Status / Current Learn / Closed Loop Compensation / Target Air/Fuel Ratio / Air/Fuel Ratio

CLOSED LOOP

Closed Loop Status / Closed Loop Compensation / Target Air/Fuel Ratio / Air/Fuel Ratio / Fuel Learn Status

SENSORS

MAP / TPS / MAT / CTS / Battery

FUEL

Engine RPM / Air/Fuel Ratio / Injection Pulse Width / Closed Loop Compensation / Fuel Duty Cycle

INITIAL STARTUP

Engine RPM / TPS / MAP / CTS / IAC position / Battery

MULTI-GAUGE

SENSORS

MAP / CTS / TPS / AFR / RPM / Battery / Ignition Timing / MAT / IAC Position / Injector Duty Cycle

VITALS

Fan #1 / Fan #2 / AC Shutdown / CTS / RPM / IAC Position / AFR / Battery / Closed Loop Status / Learn Status

AIR/FUEL RATIO

AFR / Target AFR / Coolant Enrichment / Closed Loop Compensation / RPM / Current Learn / Closed Loop Status / Learn Status / Injector Pulse Width / Fuel Flow

DASH #1

This layout is transmission focused.

Gear / RPM / Line Pressure / TCC Duty Cycle / TCC Lockup Status / Line Temp / Input Shaft Speed / TPS / Speed / Fuel Economy

DASH #2

This layout is drive-by-wire focused.

TPS / Pedal Position / Throttle Body Position / TB TPS #1 Voltage / Pedal TPS #1 Voltage / TB TPS #2 Voltage / Pedal TPS #2 Voltage / Brake Pedal Status / RPM / MAP

DASH #3

Fan #1 / Fan #2 / AC Shutdown / CTS / IAC Position / AFR / Battery / Fuel Pressure / RPM / Oil Pressure

CUSTOM DASH #1-3

Up to three (3) Custom gauge layouts can be created on the 3.5 Touch Screen. Follow these steps to configure:

- Step 1: Choose 'Dash Setup' from the Multi-Gauge screen.
- Step 2: Choose the Dash number to be configured.
- Step 3: Choose the desired layout.
- Step 4: Select channels and choose gauge display types.

CHANNELS SCALING

Each channel displayed by the 3.5 Touch Screen can be configured to have caution and warning indicators.

To do this, choose 'Channel Scaling' from the MONITOR menu. Cautions will display as Yellow and Warnings will display as RED when using the Multi-Gauge screens.

ADVANCED FEATURES

NITROUS

STAGE 1 ACTIVATION

NITROUS DISABLE

If using Terminator X for Nitrous Control, this will Enable or Disable the Stage.

MIN RPM

Minimum RPM required for Nitrous activation

MAX RPM

Maximum RPM allowed for Nitrous activation. Any RPM above this will turn off the stage.

ACTIVATION DELAY

This will delay the activation by the amount selected. The delay starts from the time the stage is triggered. A value of zero means the nitrous will turn on as soon as all activation conditions are met.

STAGE DURATION

This will set the duration of the nitrous stage, allowing a stage to be turned off at a precise time for bracket racing, or for another layer of safety. This parameter is enabled by default.

STAGE 1 TUNING

FIXED TIMING VALUE

If you are using Terminator X for timing control, this is the actual timing value the engine will operate with when the Nitrous is activated.

PROGRESSIVE CONTROL

Enable/Disable progressive timing retard curve. This parameter requires Terminator X laptop software to configure.

TIMING RETARD

1x16 editable timing curve – only available when not using a fixed timing value. This parameter requires Terminator X laptop software to configure.

TARGET AFR

Closed Loop compensation will override the target AFR table and use this value as its new target only when the nitrous is on.

BOOST

LAUNCH

LAUNCH TARGET

Allows for a specific boost level to be maintained while this input is active, as well as creates a starting point for time based boost control (when launch input is de-activated).

SAFETY SETUP

INSTANTANEOUS BOOST PRESSURE SAFETY

Boost pressure above which ignition will be instantly cut

TIME DELAY BOOST PRESSURE SAFETY

Boost pressure above which ignition will be cut (with time delay)

TIME DELAY

Amount of time actual boost must be above "time delay Boost Pressure" to activate ignition cut

BOOST VS. SPEED

BOOST CURVE

The units in this table are dome pressure, not boost pressure in the manifold.

BOOST VS. RPM

The units in these tables are dome pressure, not boost pressure in the manifold.

GEAR 1

Boost vs. RPM curve for 1st Gear

GEAR 2

Boost vs. RPM curve for 2nd Gear

GEAR 3

Boost vs. RPM curve for 3rd Gear

GEAR 4

Boost vs. RPM curve for 4th Gear

BOOST VS. GEAR

The units in these tables are dome pressure, not boost pressure in the manifold.

GEAR 1

Boost vs RPM curve for 1st Gear

GEAR 2

Boost vs. RPM curve for 2nd Gear

GEAR 3

Boost vs. RPM curve for 3rd Gear

GEAR 4

Boost vs. RPM curve for 4th Gear

BOOST VS. TIME

BOOST CURVE

This operating mode only has one curve. The units in the table are dome pressure, not boost pressure in the manifold.

LAUNCH

2-STEP

REV LIMITER #1 ENABLE

Enable or Disable Rev Limiter #1.

REV LIMITER #1 INPUT

Allows the user to select an available ECU input pin. See THE "INPUT & OUTPUTS" SECTION for more information on the input and outputs.

REV LIMITER #1 TYPE

View and edit rev limiter #1 type. There are five types to choose from:

- Fuel Only – performs a "hard cut" of fuel flow only when the main over-rev HIGH RPM is hit. "Hard cut" means that fuel flow is stopped to all cylinders until the main over-rev LOW RPM setting is met.
- Spark Only – performs a "hard cut" of ignition only when the main over-rev HIGH RPM is hit. "Hard cut" means that ignition is stopped to all cylinders until the main over-rev LOW RPM setting is met.
- Fuel and Spark – performs a "hard cut" of ignition AND fuel flow when the main over-rev high RPM is hit.
- Soft – begins a "soft cut" of ignition when the main over-rev LOW RPM is hit. "Soft cut" means that ignition will be removed from individual cylinders as needed to limit RPM. If the HIGH RPM limit is reached, a hard cut will be implemented.
- Spark, high only – this type has a single high side value. It is recommended to use this for a 2-step rev limiter and as a high side rev limiter.

IT IS USUALLY BEST TO HAVE A NARROW RANGE (20-50 RPM) BETWEEN THE LOW AND HIGH RPM SETTINGS TO REDUCE STRESS ON THE ENGINE.

REV LIMITER #1 ON RPM

See Rev limiter types above.

REV LIMITER #1 OFF RPM

See Rev limiter types above.

NOT AVAILABLE FOR REV LIMITER TYPE "SPARK, HIGH ONLY"

LAUNCH RETARD

SETUP

LAUNCH RETARD ENABLE

Enable or Disable Launch Retard.

TYPE

Select the launch retard table units (Time or RPM).

LAUNCH RETARD ACTIVATION

Select whether the launch retard activates with an input, or at the release of an input (i.e. transbrake button).

LAUNCH RETARD INPUT

Allows the user to select an available ECU input pin. See THE "INPUT & OUTPUTS" SECTION for more information on the input and outputs.

TUNING

LAUNCH RETARD

The table values are in degrees of retard, so a value of 5 would equate to a 5 degree retard in total timing .

MIN RPM

If RPM was selected as the table unit type, this is the first RPM point in the retard table.

MAX RPM

If RPM was selected as the table unit type, this is the last RPM point in the retard table .

MIN TIME

If time was selected as the table unit type, this is the first time point in the retard table .

MAX TIME

If time was selected as the table unit type, this is the last time point in the retard table .

THE LAUNCH RETARD OPERATES OFF A 1X16 TABLE. THE BREAK-POINTS OF THE TABLE ARE FILLED IN A LINEAR FASHION BETWEEN THE MIN AND MAX (TIME OR RPM) INPUT VALUES. FINE TUNING OF THESE POINTS CAN BE DONE BY SELECTING TABLE ICON IN THE GRAPH EDITOR.

ADVANCED ICF

The configurations in the advanced tables must be setup using Terminator X Software. Once those are configured, a limited number of parameters may be adjusted in the handheld. Please read the Terminator X Software instructions to learn about and properly setup Advanced Tables.

1D TABLES

TABLE #1

ENABLE

Enables or disables the advanced table

TABLE TYPE

Displays the table type

TIME DELAY ENABLE

Enables or disables the table's activation time delay

TIME DELAY TO START

Edits the activation time delay

EDIT CURVE

Allows editing of the 1x16 table

TABLE #2

See table #1 above

TABLE #3

See table #1 above

TABLE #4

See table #1 above

2D TABLES

TABLE #1

ENABLE

Enables or disables the advanced table

TABLE TYPE

Displays the table type

TIME DELAY ENABLE

Enables or disables the table's activation time delay

TIME DELAY TO START

Edits the activation time delay

EDIT TABLE

Allows editing of the 16x16 table

TABLE #2

See table #1 above

TABLE #3

See table #1 above

TABLE #4

See table #1 above

LOGGING

Terminator X MPFI systems come standard with powerful data logging capabilities. Logging can be stopped and started via the 3.5" Handheld, and the data logs will save automatically to the SD card.

Choosing 'Files' in the DATA LOGGING menu will display all logs contained on the SD card

Automatic log triggering can be configured by choosing the setup icon.

Data logs are timestamped and named using the following format:

TermX_YYMMDD-hhmmss-XX.dlz

Terminator X data logs can be viewed through the free Terminator X PC software.

FILE

ECU OVERVIEW

PAGE 1

CURRENT GLOBAL FOLDER/FILE

Displays the name of the current ECU calibration

TRANSMISSION TYPE

Displays the Calibration's configured transmission type

IGNITION INPUT TYPE

Displays the current Ignition Type

WIDE BAND O2 SENSOR TYPE

Displays the current O2 sensor type

INJECTION TYPE

Displays the current injection strategy

SYSTEM TYPE

Displays injector information

PAGE 2

ECU FIRMWARE VERSION

Displays ECU firmware version

ECU TIME

Displays the ECU time. This time can be synced with actual time using Terminator X Software.

TPS AUTOSET

Indicates whether a TPS autosest has been performed

LOCAL SETUP

TOUCH CALIBRATE

The touch screen can be recalibrated by following the on-screen instructions.

LOCAL INFO

Displays detailed handheld touchscreen firmware information

LOCAL OPTIONS

RESTORE SCREENS ON STARTUP

SELECTING THIS OPTION WILL RESTORE THE HANDHELD TO THE LAST SCREEN IT WAS ON BEFORE IT WAS POWERED OFF.

DO NOT SHOW ADVANCED FEATURES WARNING

THIS WILL DISABLE THE WARNING THAT IS SHOWN WHENEVER THE ADVANCED FEATURES ICON IS SELECTED.

SHOW TEMPERATURES IN °C

THIS WILL CONVERT TEMPERATURES SHOWN ON THE HANDHELD TO CELSIUS.

THIS HAS NO EFFECT ON ECU FIRMWARE OR SOFTWARE TUNING – IT IS A HANDHELD DISPLAY CONVERSION ONLY.

RESTORE CHANNEL DEFAULTS

THIS WILL RESTORE ANY USER CUSTOMIZED CHANNEL WARNING INDICATORS TO THE FACTORY DEFAULT VALUES.

SCREEN BRIGHTNESS

SCREEN BRIGHTNESS CAN BE MANUALLY ADJUSTED HERE. 0% IS THE LOWEST BRIGHTNESS SETTING, AND 100% IS THE BRIGHTEST.

ECU HW/FW

This screen displays more detailed Terminator X ECU information, and is also where you go to upgrade ECU firmware.



GLOBAL CONFIGS

List view of all saved Sniper calibrations on the SD card. This is where you can save, rename, and upload saved ECU calibrations (i.e. pump gas tune, race gas tune).

LAPTOP SUPPORT

Your Terminator X system supports advanced tuning and data log review through use of the free software, which can be downloaded here. Live tuning requires a 558-443 CAN to USB cable.

Calibrations and data logs can also be loaded to Terminator X software by using the handheld's SD card.

DOWNLOADING & LOADING CALIBRATIONS FROM THE TERMINATOR X TO AN SD CARD:

Downloading Calibration from ECU

1. Press "File" icon from the Main Menu

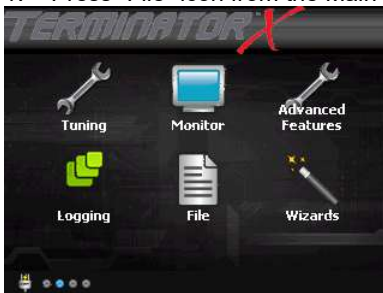

2. Press the "Global Configs" Icon



3. Press "Download From ECU"



Press "OK", if you would like to name it with a unique name, user can press "Save GCF as", type the name for the calibration, and press save.

4. SD card now has the Global Configuration that is in the ECU unit, this can be opened up with the Terminator X software on a PC.

Loading Calibration into Terminator X ECU

1. Press "File" icon from the Main Menu

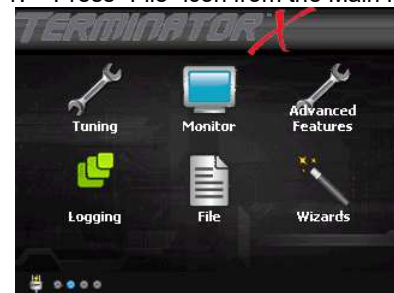

2. Press the "Global Configs" Icon



3. Highlight the Configuration you would like to load into the Terminator X (making it highlight in Blue).



4. Press Upload to ECU and follow the Onscreen Prompts:
 - a. Press okay when it asks, "Upload GCF to ECU"
 - b. Turn the ignition off for at least 4 seconds when it asks you to. If you press OK, the upload of the calibration will not take place until the ignition is cycled.
5. New Configuration has been uploaded to the Terminator X ECU.

INPUTS & OUTPUTS

The Terminator X ECU contains 4 configurable inputs and 4 configurable outputs:

Base calibrations are pre-configured with 3 outputs and one input to be used for the following features:

Electric Fan #1 output

Electric Fan #2 output

Air Conditioning Shutdown at Wide Open Throttle

IAC Kick Input

Additional features such as a launch retard or 2-step rev limiting can be configured through the handheld without the use of software.

The following chart lists the connector and wire color information for all of the inputs and outputs to aid in wiring and setup:

Name	ECU PIN	Harness Connector	Wire Color	Function	Type
Input 1	A12	A	White/Blue	IAC Kick	Ground
Input 2	A3	B	White/Red	Unassigned	Ground
Input 3	A13	C	White/Black	Unassigned	Ground
Input 4	A4	D	White/Green	Unassigned	Ground
Output 1	B12	E	Grey/Yellow	Electric Fan 1	Ground
Output 2	B11	F	Grey/Red	Electric Fan 2	Ground
Output 3	B10	G	Grey/Black	AC Shutdown	Ground
Output 4	B3	H	Grey/Green	Unassigned	Ground

Further customization of the inputs and outputs, including changing their signal type can be performed via Terminator X software.

APPENDIX 1.0 – ECU PINOUT

The following shows pins that are used on TERMINATOR X™ systems. Pins that are not populated on TERMINATOR™ systems are denoted with an asterisk (*).

J1A Connector

Pin	Function
A1	Coil – Input
A2	Fuel Pump Relay Out (+12v) (10A Max)
A3	Input #2 (F,5,2,T,H,G)
A4	Input #4 (F,G,5)
A5	TPS Input
A6	Points Output
A7	WB1 COMPR2
A8	WB1 Shield
A9	WB HTR -
A10	Switched +12v Input
A11	Manifold Air Temp Input
A12	Input #1 (F,5,2,T,H,G)
A13	Input #3 (F,G,5)
A14	Cam/Crank Ground
A15	Gauge Output
A16	WB1 COMPR1
A17	WB1 VS-/IP+
A18	Sensor Ground
A19	Engine Coolant Temp Input
A20	Oil Pressure Input
A21	Knock Sensor #2 Input
A22	Cam Input / Bypass Out
A23	Map Sensor Input
A24	CAN Lo
A25	WB1 VS+
A26	Sensor +5v
A27	Bypass Out
A28	EST/Spout Output
A29	Knock Sensor #1 Input
A30	Crank Speed Input
A31	Fuel Pressure Input
A32	CAN Hi
A33	WB1 IP+
A34	WB HTR +

J1B Connector

Pin	Function
B1	IAC A Lo
B2	IAC A Hi
B3	PWM #4 Output (HG)
B4	Injector F (Cylinder 6)
B5	Injector G (Cylinder 7)
B6	Injector H (Cylinder 8)
B7	Injector E (Cylinder 5)
B8	IAC B Lo
B9	IAC B Hi
B10	PWM #3 Output (HG)
B11	PWM #2 Output (HG)
B12	PWM #1 Output (HG)
B13	Injector D (Cylinder 4)
B14	Ground
B15	EST B (Cylinder 2)
B16	EST D (Cylinder 4)
B17	EST F (Cylinder 6)
B18	EST H (Cylinder 8)
B19	Injector A (Cylinder 1)
B20	EST 12V Output
B21	EST A (Cylinder 1)
B22	EST C (Cylinder 3)
B23	EST E (Cylinder 5)
B24	EST G (Cylinder 7)
B25	Injector C (Cylinder 3)
B26	Injector B (Cylinder 2)

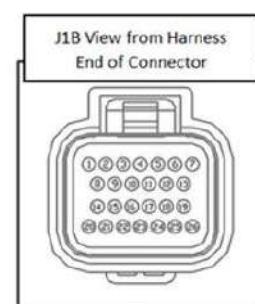
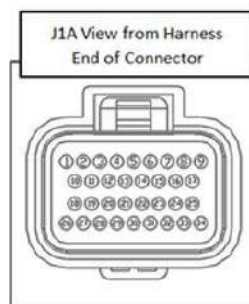

APPENDIX 2.0 – ENGINE CONNECTOR AND INJECTOR INFORMATION

THERE ARE THREE VARIATIONS OF LS INJECTOR CONNECTORS:

EV1

INJECTOR HARNESS PART NUMBER 558-200

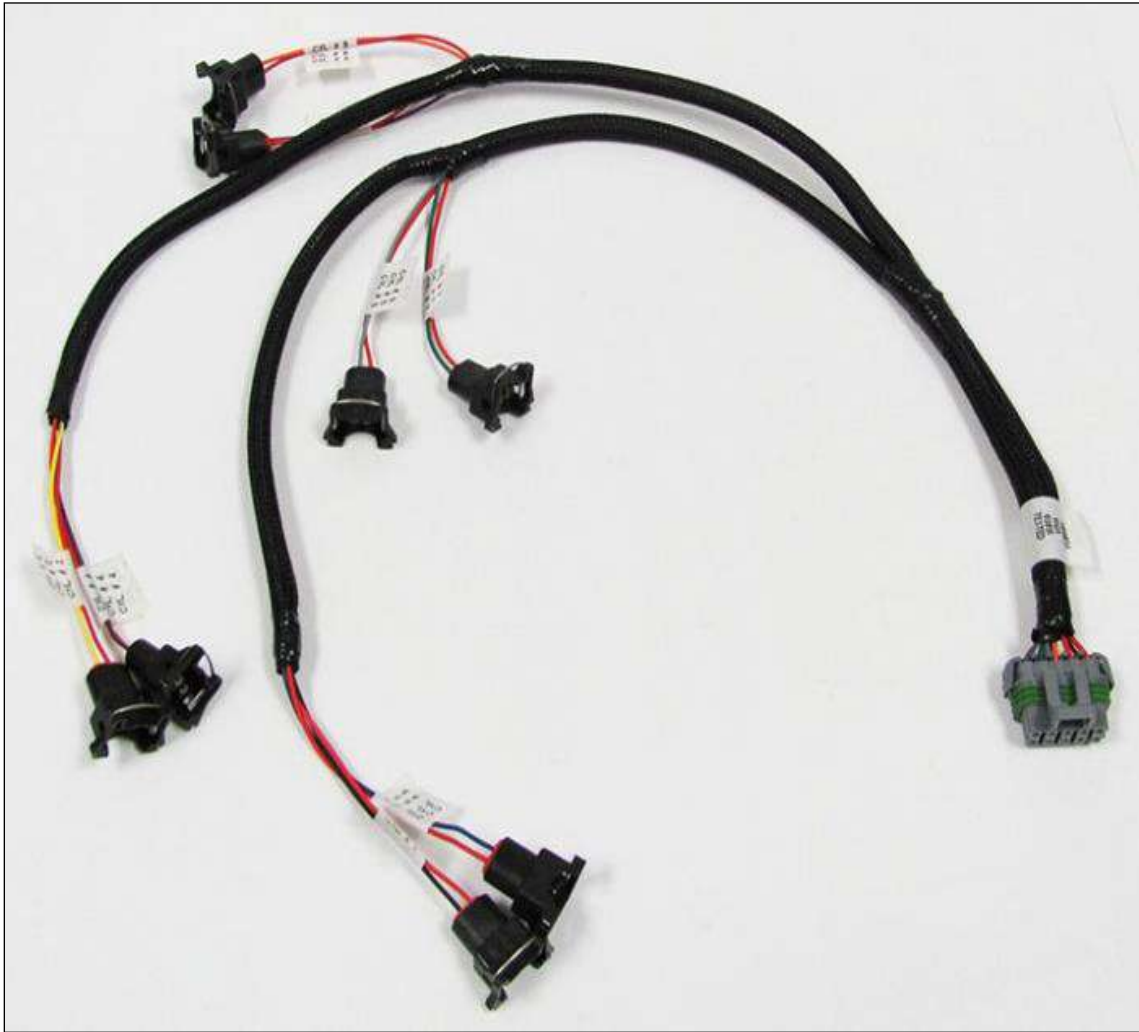

EV6

INJECTOR HARNESS PART NUMBER 558-201

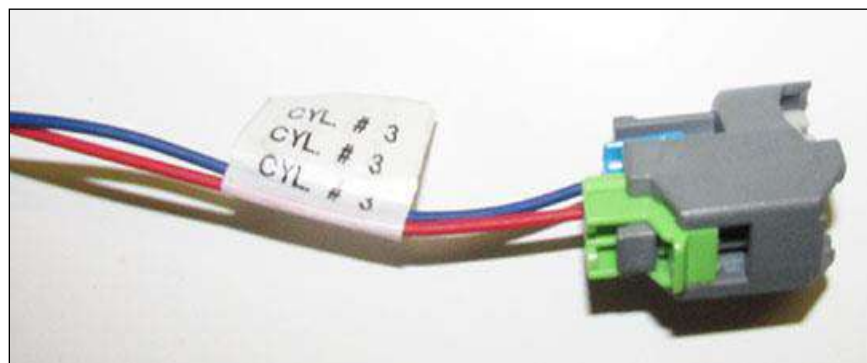

MULTEC2

INJECTOR HARNESS PART NUMBER 558-214

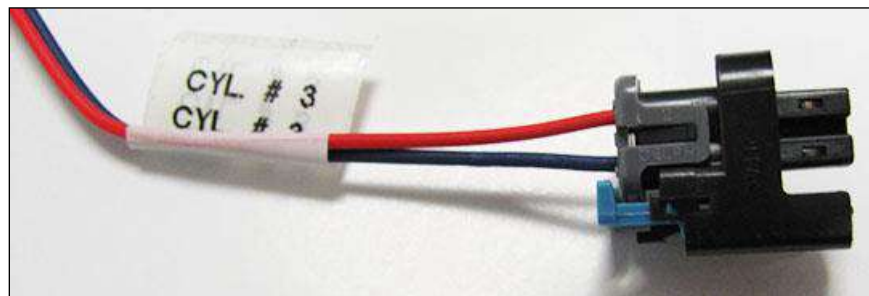
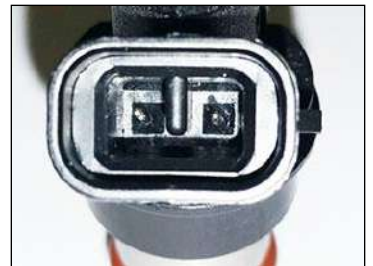
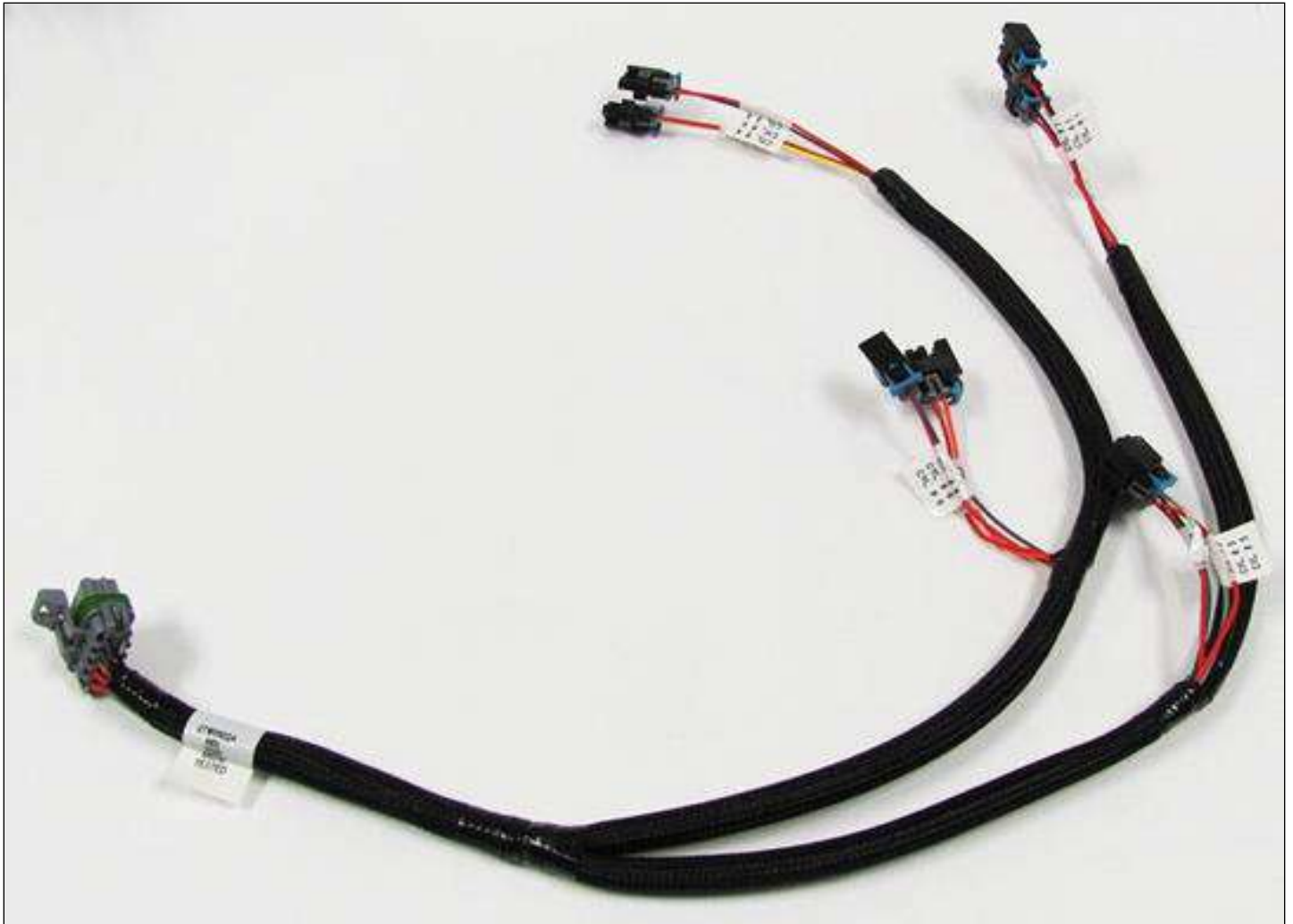

SUPPORTED FUEL INJECTORS

TERMINATOR X ECUS ONLY SUPPORT HIGH IMPEDANCE INJECTORS. THE USE OF LOW IMPEDANCE INJECTORS WILL DAMAGE THE ECU AND VOID THE WARRANTY.

The list below outlines injectors that are preconfigured selectable through the wizard. If your injectors are not on this list, Terminator X software will be required to configure before starting your engine.

GM	Holley	Sniper	Other
LS3 12576341	19LB Holley 522-198	Sniper 42 lb/hr (522-428S)	60LB Siemens Dekaflex IV
GM 12580426 5.3 Flex Fuel	24LB Holley 522-248		FIC 525H
GM 12580681	30LB Holley 522-308		FIC 650H
GM 17113698	36LB Holley 522-368		FIC 775H
GM 25317628	42LB Holley 522-428		FIC 850H
GM 17113553	48LB Holley 522-488		FIC 1000H
GM 25323974			FIC 1100H
GM 25320288			FIC 1650H
GM 89017586			FIC 2150H
GM 12594512			
GM 12609749			
GM 12613411			
GM 12587269			
GM 12613412			

APPENDIX 3.0 – THROTTLE BODIES AND PEDALS

There are two styles of DBW throttle body connectors. The following part numbers are supported by Holley Terminator MPFI kits:

6 PIN CONNECTOR (LATE)

DRIVE BY WIRE HARNESS PART NUMBER 558-406

- 12570790
 - 2005-2008 Corvette, CTS-V and GTO
 - VIN Codes: E, U, W, Y
 - Engine Codes: L76, LQ4 (car), LS2, LS3, LS7
- 12580760
 - 2005-2008 Truck
 - VIN Codes: 0, 3, 4, 5, 8, C, H, J, K, L, M, Y
 - Engine Codes: L76, L92, LC9, LFA, LH6, LMF, LMG, LS2, LY2, LY5, LY6
- 12605109
 - 2009-2013 Corvette, Camaro, G8
 - VIN Codes: E, J, W, Y
 - Engine Codes: L76, L99, LS3, LS7
- 12629992
 - 2009+ Truck
 - VIN Codes: 0, 2, 3, 4, 5, 7, 8, A, B, C, F, G, H, J, K, L, M, P, Y
 - Engine Codes: L20, L76, L92, L94, L96, L9H, LC8, LC9, LFA, LH6, LH8, LH9, LMF, LMG, LS2, LY2, LY5, LY6, LZ1
- 17113669
 - 2001 thru 2005 Corvette & CTS-V
 - VIN Codes: G,S
 - Engine Codes: LS1, LS6



8 PIN CONNECTOR (EARLY TRUCK)

DRIVE BY WIRE HARNESS PART NUMBER 558-429

- 12570800
 - 2002-2007 Truck
 - VIN Codes: B, N, P, T, U, V, Z
 - Engine Codes: L33, L59, LM4, LM7, LQ4 (truck), LQ9, LR4



THROTTLE PEDAL

Holley recommends GM P/N - 10379038 which is a passenger car pedal with a 6 pin connector.



APPENDIX 4.0 – DIAGNOSTIC LEDS

LED#	Function	Color	Definition
1	Heartbeat	Green/Flash	ECU is powered
2	Engine running	Green	Engine is running
		Yellow	Engine is not running
3	Wideband status	Blue	too hot, too cold, slow warmup, uncalibrated
		Green	sensor is active and functioning properly
		Red	sensor is open or needs to be replaced
		Yellow	sensor is heating
		Off	sensor is disabled
4	TPS calibrated	Green	Calibrated
		Red	If DBW = Pedal & TB Calibration Error
			If non DBW - Calibration Error
		Cyan	DBW Pedal Calibration Error
		Purple	DBW TB Calibration Error
5	Off/undefined		Future
6	Crank	Green	When below Crank to Run RPM, tooth detected
		Blue	When below Crank to Run RPM, gap detected
		Red	Crank error detected -If engine continues to run, will stay Red until ECU is powered off -If engine shuts off due to severe signal loss, will stay Red until RPM re-sync OR key cycle
		Off	When above Crank to Run RPM and ECU is properly syncd
7	Cam	Green	When below Crank to Run RPM, tooth detected
		Blue	When below Crank to Run RPM, gap detected
		Red	Cam error detected -If engine continues to run, will stay Red until ECU is powered off -If engine shuts off due to severe signal loss, will stay Red until RPM re-sync OR key cycle
		Off	When above Crank to Run RPM and ECU is properly syncd
8	Off/undefined		Future

558-102 LS1/6 ENGINE MAIN HARNESS

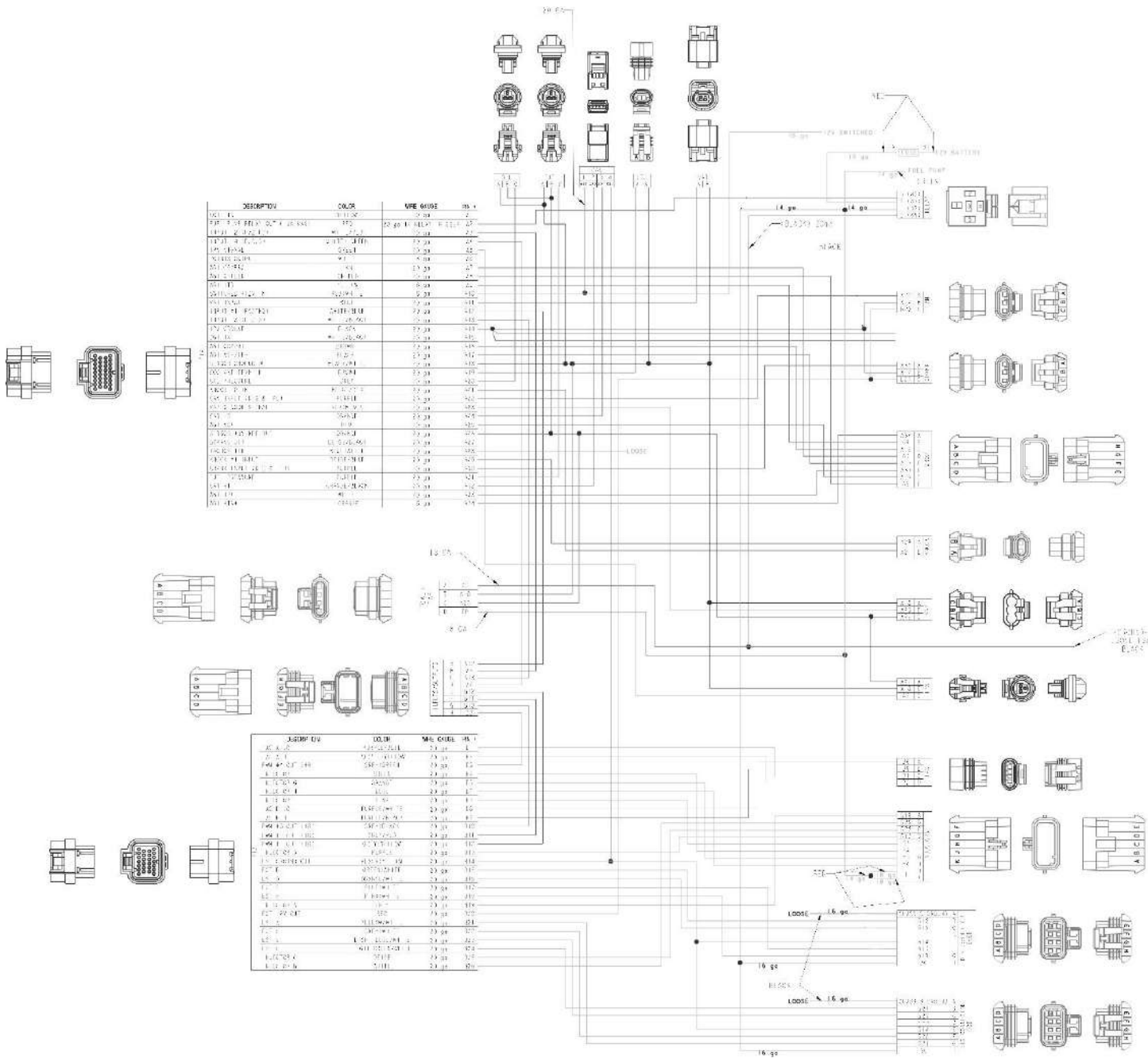

558-405 4L60/80E TRANSMISSION HARNESS

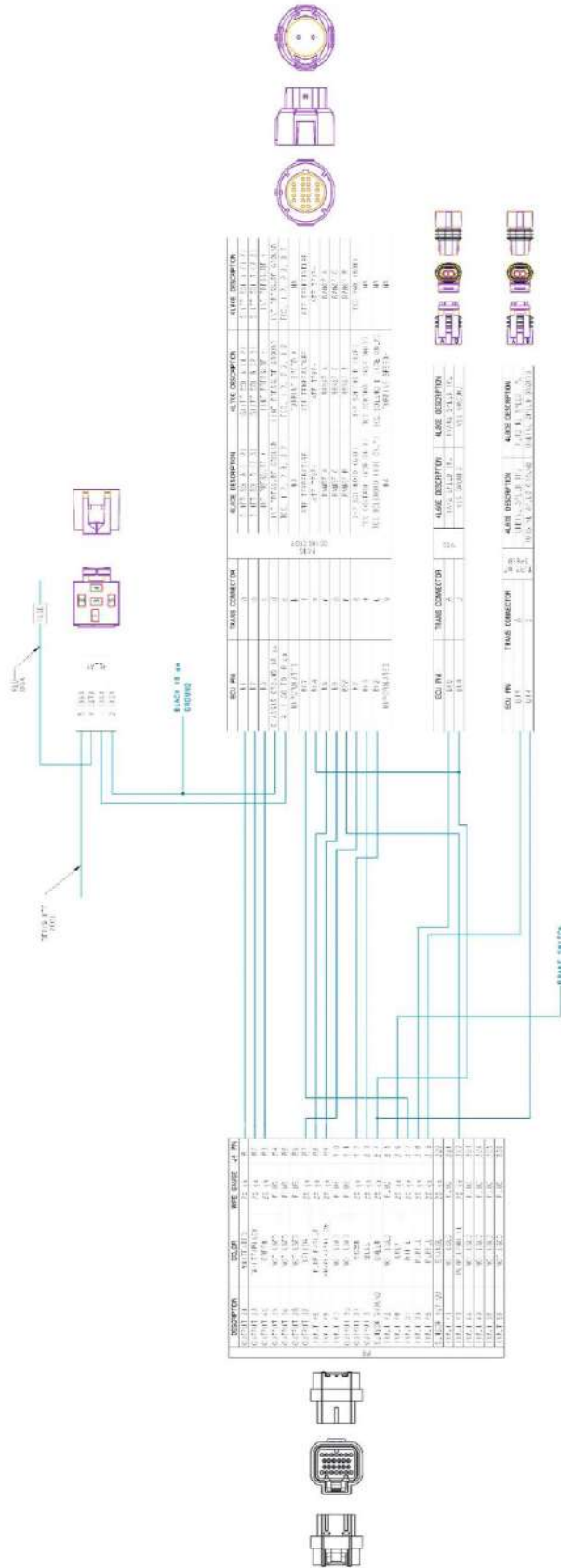

558-406 DRIVE BY WIRE HARNESS (LATE)

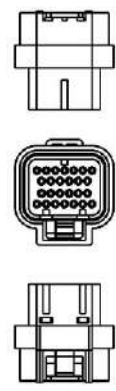
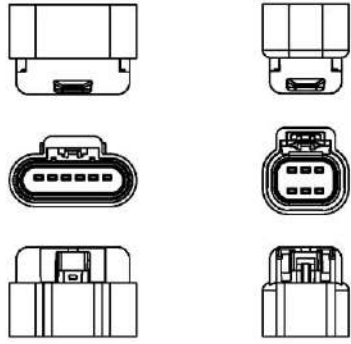
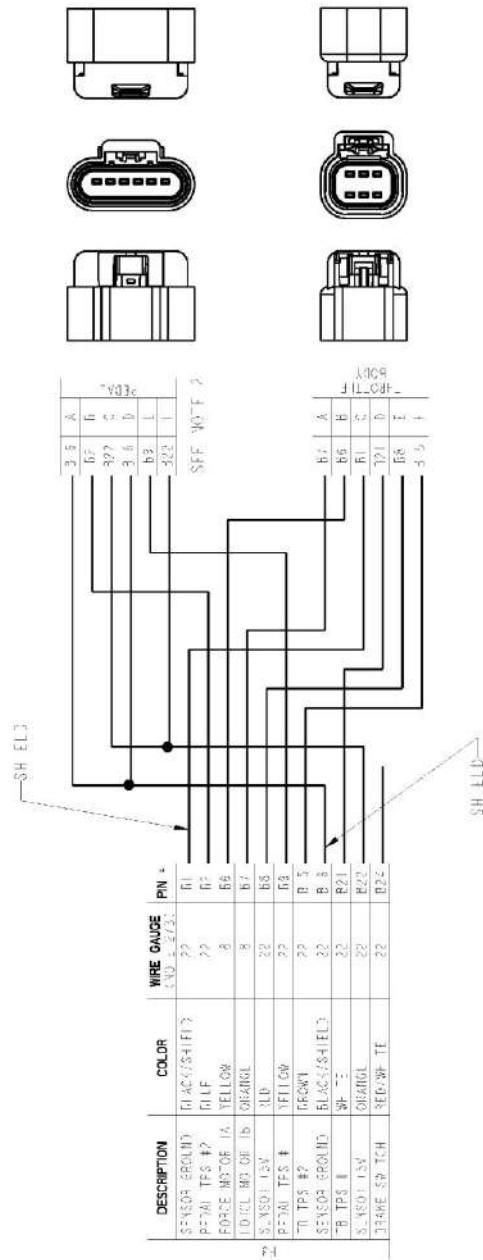

558-429 DRIVE BY WIRE HARNESS (EARLY TRUCK)

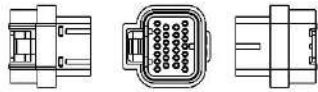
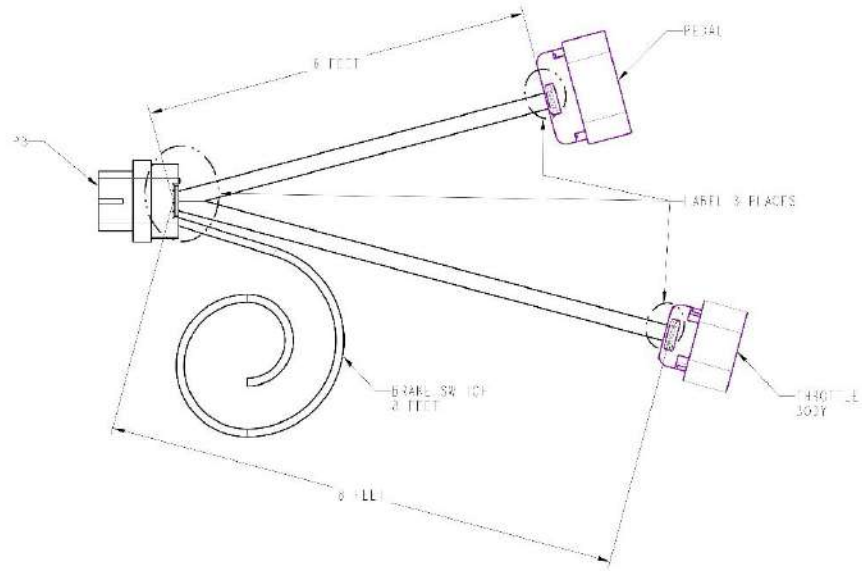

DESCRIPTION	COLOR	WIRE GAUGE	PN#
STRIPED BRN/BLU	3 AC445-1710	22	6
PURP. 1/2S #2	3-LL	22	62
ORNG. W/TCR 1A	17110A	8	56
ORNG. W/TCR 1	ORNGE	8	54
STRIPED SV	RED	22	58
PURP. 1/2S 11	1-1110A	22	69
16 P/S #2	ORNG	22	D15
STRIPED BRN/BLU	3 AC445-1710	22	P16
16 P/S #1	WHIT	22	U21
STRIPED SV	ORNGE	22	R22
CHARK. SWITCH	RED/WHIT	22	U24

