

TERMINATOR[™]X

TERMINATOR[™]X MAX

MPFI FUEL INJECTION SYSTEM

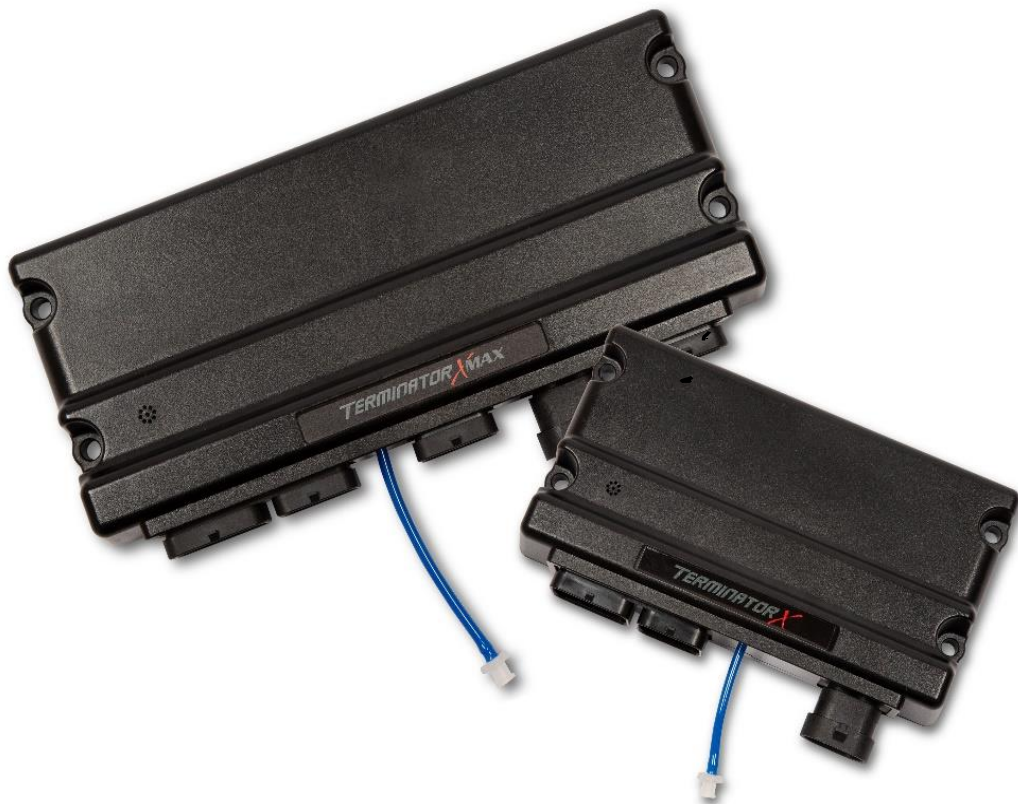

QUICK START MANUAL – 199R11956

NOTE: These instructions must be read and fully understood before beginning installation. If this manual is not fully understood, installation should not be attempted. Failure to follow these instructions, including the pictures may result in subsequent system failure.

TABLE OF CONTENTS:

- 1.0 INTRODUCTION
- 2.0 WARNINGS, NOTES, AND NOTICES
- 3.0 ADDITIONAL ITEMS REQUIRED FOR INSTALLATION
- 4.0 TOOLS REQUIRED FOR INSTALLATION
- 5.0 REMOVAL OF EXISTING COMPONENTS
- 6.0 TERMINATOR X MPFI SYSTEM INSTALLATION
 - 6.1 Fuel Pump, Fuel Line, and Filter Installation
 - 6.2 Oxygen Sensor Installation
 - 6.2.1 Oxygen Sensor Mounting Procedure
 - 6.3 ECU Mounting
- 7.0 WIRING
 - 7.1 Important Wiring "Do's and Don'ts"
- 8.0 WIRING HARNESS INSTALLATION
 - 8.1 Main Power/Battery Connection
- 9.0 PRIMARY HARNESS INSTALLATION AND SENSOR CONNECTIONS
 - 9.1 ECU Connectors
 - 9.2 Harness Routing
 - 9.3 Sensor Connections & Outputs
 - 9.3.1 Oil Pressure Sensor
 - 9.3.2 Coolant Temperature Sensor (CTS)
 - 9.3.3 Wide Band Oxygen Sensor (WBO2)
 - 9.3.4 Fuel Pressure (Fuel)
 - 9.3.5 Manifold Air Temperature (MAT)
 - 9.3.6 Ignition / Crank and Cam Sensors
 - 9.3.8 Knock Sensors
 - 9.3.9 Manifold Absolute Pressure sensor (MAP)
 - 9.3.10 Throttle Position Sensor (TPS)
 - 9.3.11 Idle Air Control (IAC)
 - 9.3.12 Fuel Injectors
 - 9.3.13 Ignition Coils
 - 9.3.14 Coil Ground Wires
 - 9.3.15 Handheld Connections - (CAN1)
- 10.0 LOOSE WIRES
- 11.0 ADDITIONAL INPUTS & OUTPUTS
- 12.0 TRANSMISSION HARNESS
 - 12.1 GM Transmission Wiring
 - 12.2 Ford Transmission Wiring
- 13.0 DRIVE-BY-WIRE HARNESS
 - 13.1 Overview
 - 13.2 Warnings!
 - 13.3 Installation
 - 13.4 System Safeties
 - 13.5 Throttle Body "Limp Home" Position
 - 13.6 Drive-By-Wire DO'S and DON'TS
 - 13.7 GM DBW Wiring
 - 13.8 Ford DBW Wiring
 - 13.9 Chrysler DBW Wiring
- 14.0 FINAL ECU CONNECTION
- 15.0 TERMINATOR X™ INSTRUCTIONS AND TUNING
- 16.0 INITIAL POWER-UP
- 17.0 HANDHELD NAVIGATION & USE
 - 17.1 Making Adjustments
- 18.0 HOME SCREEN
- 19.0 CALIBRATION WIZARD
- 20.0 TPS AUTOSET
- 21.0 SENSOR VERIFICATION
- 22.0 STARTUP
- 23.0 AFTER-STARTUP
- 24.0 IDLE SETTING/CABLE OPERATED THROTTLE PLATE SETTING
- 25.0 SELF-TUNING
- 26.0 IGNITION WIRING DIAGRAMS
- 27.0 DIAGNOSTIC LED'S

1.0 INTRODUCTION

Holley Performance Products has written this manual for the installation of the **TERMINATOR X™ MPFI** fuel injection system. This manual contains the information necessary for the installation of the hardware contained in this kit, which includes the ECU, wiring, and 3.5" touch screen. It also contains basic tuning information. This instruction sheet does not include installation instructions for the fuel system (pump, filters, regulators and lines). Please read all the **WARNINGS** and **NOTES**, as they contain valuable information that can save you time and money. It is our intent to provide the best possible products for our customer; products that perform properly and satisfy your expectations. Should you need information or parts assistance, please contact our technical service department, Monday through Friday. By using this number, you may obtain any information and/or parts assistance that you may require. Please have the part number of the product you purchased when you call.

2.0 WARNINGS, NOTES, AND NOTICES

NOTE: This system does not contain fuel system components that are required including the fuel pump, fuel filters, fuel pressure regulator, and lines. Holley offers complete kits can be purchased separately (526-1, 526-2, 526-3, & 526-4).

WARNING! The **TERMINATOR X MPFI** systems consist of a number of sophisticated components. Failure of any one component does not constitute, nor does it justify, warranty of the complete system. Individual service items are available for replacement of components. If assistance is required or if you need further warranty clarification, you can call Holley Technical Service at the number shown above.

WARNING! To preserve warranty, these instructions must be read and followed thoroughly and completely before and during installation. It is important that you become familiar with the parts and the installation of the **TERMINATOR X MPFI** system before you begin. Failure to read and understand these instructions could result in damage to **TERMINATOR X MPFI** components that are not covered by the warranty and could result in serious personal injury and property damage.

WARNING! The oxygen sensor in this kit is recommended for use with **ONLY** unleaded fuel. Use of leaded fuels will degrade the oxygen sensor and will result in incorrect exhaust gas oxygen readings and improper fuel delivery. Failure to follow these directions does not constitute the right to a warranty claim.

WARNING! Failure to follow all of the above will result in an improper installation, which may lead to personal injury, including death, and/or property damage. Improper installation and/or use of this or any Holley product will void all warranties.

WARNING! Use of some RTV silicone sealers will destroy the oxygen sensor used with this product. Ensure the RTV silicone sealant you use is compatible with oxygen sensor vehicles. This information should be found on the RTV package.

WARNING! For the safety and protection of you and others, only a trained mechanic having adequate fuel system experience must perform the installation, adjustment, and repair. It is particularly important to remember one of the very basic principles of safety: fuel vapors are heavier than air and tend to collect in low places where an explosive fuel/air mixture may be ignited by any spark or flame resulting in property damage, personal injury, and/or death. Extreme caution must be exercised to prevent spillage and thus eliminate the formation of such fuel vapors.

WARNING! This type of work **MUST** be performed in a well-ventilated area. Do not smoke or have an open flame present near gasoline vapors or an explosion may result.

3.0 ADDITIONAL ITEMS REQUIRED FOR INSTALLATION

- Fuel System
- Return Fuel Lines

A 0-100 psi fuel gauge or pressure transducer is recommended to check for proper fuel pressure. PN 554-102 is a 0-100 PSI pressure sensor that can be purchased as well that will plug into the **TERMINATOR X™** harness to check and monitor fuel pressure. It requires a 1/8" NPT port for installation (Holley fuel pressure regulators have a 1/8" NPT port).

4.0 TOOLS REQUIRED FOR INSTALLATION

- Standard wrench set
- Medium blade screwdriver
- Drill and assorted bit sizes
- Factory Service Manual for your vehicle
- Small blade screwdriver
- #2 Phillips screwdriver
- Hole saw (2") (depending on ECU location)
- O2 Bung Installation (drilling, welding)
- Allen wrench set
- Digital volt meter
- Terminal crimping tool

An assistant is necessary for some installation and adjustment procedures and should be present for safety reasons.

5.0 REMOVAL OF EXISTING COMPONENTS

1. Disconnect the battery.
2. If applicable, remove the existing OEM main wiring harness and injector harness. Consult the factory service manual for details on how to properly remove the harness.

6.0 TERMINATOR X MPFI SYSTEM INSTALLATION

6.1 Fuel Pump, Fuel Line, and Filter Installation

A complete high pressure EFI fuel system must be installed for the TERMINATOR X™. The pump should be capable of supplying a minimum of 255 liters/hour or 400 lb./hr. of fuel at 43 psi. If using an in-line fuel pump, there should be a coarse pre-filter before the pump. All systems should contain a 10 micron post filter after the fuel pump. An EFI fuel pressure regulator is required. It should be installed after the fuel rail. See **Figure 1** below for proper fuel system plumbing.

Holley offers multiple fuel system kits. These kits contain all components except the return line. Examples of these kits are:

- 526-1 – Braided Stainless Lines, Billet Pump, Regulator, and Filters
- 526-2 – Pro-Lite 350 Hose, Billet Pump, Regulator, and Filters
- 526-3 – Super Stock Hose, Billet Regulator, 12-920 Fuel Pump, and Filter
- 526-4 – Super Stock Hose, Billet Regulator, 12-920 Pump, and Metal Filters

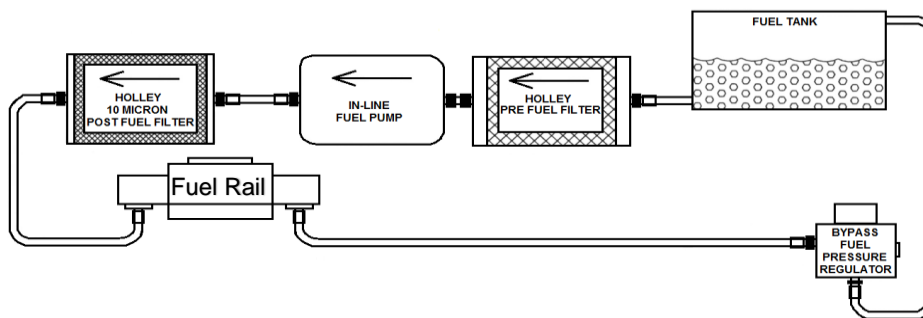

Figure 1

6.2 Oxygen Sensor Installation

The oxygen sensor should be mounted at a point where it can read a good average of all the cylinders on one bank. This would be slightly after all the cylinders merge. Do NOT mount the sensor far back in the exhaust as this will negatively impact closed loop operation response. If you have long tube headers, mount the sensor approximately 1-10" after the collector. You must have no less than 18 – 24" of exhaust pipe after the sensor.

TERMINATOR X™ EFI systems come with a Bosch LSU 4.9 wideband oxygen sensor. Make sure your sensor looks like **Figure 2**.



Figure 2

6.2.1 Oxygen Sensor Mounting Procedure

NOTE: Never run the engine with the oxygen sensor installed if it is not plugged in and powered by the ECU, or it will be damaged. If you need to plug the hole temporarily, use an O₂ sensor plug or a spark plug with an 18mm thread.

NOTE: Someone with experience in welding exhaust systems should install the oxygen sensor boss. Any competent exhaust shop will be able to perform this task at a minimum cost. (Note: If you weld on the car, make sure all wiring to the ECU is disconnected, and it's best to remove the ECU from the vehicle when welding).

WARNING! Use of leaded fuel will degrade an oxygen sensor. Prolonged use is not recommended unless periodic replacement is performed.

WARNING! Use of some RTV silicone sealers will destroy the oxygen sensor used with this product. Ensure the RTV silicone sealant you use is compatible with oxygen sensor vehicles. This information should be found on the RTV package.

1. Locate a position for the oxygen sensor as close to the engine as possible. If your vehicle has catalytic converters, the oxygen sensor MUST be located between the engine and the catalytic converters.

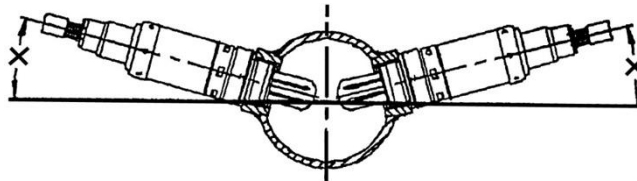

Figure 3

NOTE: The oxygen sensor should be mounted in such a way that the condensation in the exhaust tubing will not enter the sensor. Mount the O₂ sensor in the upper half of the exhaust tubing, with the angle "x", shown above, being greater than 10°. **Figure 3** indicates that the sensor can be mounted on either side of the exhaust tubing.

2. Drill a 7/8" hole in the location picked for the sensor. Weld the threaded boss into the 7/8" hole. Weld all the way around the boss to insure a leak proof connection. Install the oxygen sensor into the threaded boss and tighten securely. It is a good idea to add anti-seize to the threads to aid in removal. Do not get any anti-seize on the tip of the sensor.
3. On vehicles equipped with an AIR pump, the oxygen sensor must be mounted before the AIR injection into the exhaust, or the AIR pump must be disconnected. Holley recommends that if the AIR is injected into both exhaust manifolds, mount the oxygen sensor into the pipe immediately after the exhaust manifold. Disconnect the AIR pump tube from the exhaust manifold and plug both ends. Check with local ordinances for the legality of this procedure in your area.

WARNING! Failure to disconnect the AIR pump or locating the oxygen sensor downstream from AIR injection will result in an extremely rich mixture, which could cause drivability problems and severe engine damage.

6.3 ECU Mounting

The ECU can be mounted inside the passenger compartment (preferable location) or in the engine compartment. If mounted in the engine compartment, follow these guidelines:

- The ECU should be located such that it isn't being directly hit by water or road debris.
- It should also be located such that it isn't extremely close to exhaust manifolds or headers.
- It should be mounted such that it is as far away from spark plug wires, CD ignition boxes, or other "electrically noisy" devices as is reasonably possible.
- Make sure the connector end of the ECU is pointed DOWN such that water can't make its way into the ECU terminals.

Do not over-tighten mounting hardware if the ECU is not mounted on a flat surface.

7.0 WIRING

This section overviews how to properly install the wiring harnesses for this system.

7.1 Important Wiring "Do's and Don'ts"

An EFI system depends heavily on being supplied a clean and constant voltage source. The grounds of an electrical system are just as important as the power side.

TERMINATOR X™ ECU's contain multiple processing devices that require clean power and ground sources. The wiring harnesses for them must be installed in such a manner that they are separated from "dirty" power and ground sources.

DO'S

- Install the main power and ground directly to the battery. *To the POSTS/TERMINALS, not to any other place!*
- Keep sensor wiring away from high voltage or “noisy/dirty” components and wiring, especially secondary ignition wiring (plug wires), ignition boxes and associated wiring. It is best that the plug wires not physically contact any EFI wires.
- Properly crimp or crimp and solder any wire connections. Apply quality heat shrink over any of these connections.
- It is critical that the engine has a proper ground connection to the battery and chassis.

DON'TS

- NEVER run high voltage or “noisy/dirty” wires in parallel (bundle/loom together) with any EFI sensor wiring. If wires need to cross, try to do so at an angle.
- Do not use the electric fan outputs to directly power a fan. They must only trigger a relay.
- Do not use improper crimping tools.
- Don't use things like “t-taps”, etc. Use proper crimpers/solder and heat shrink.
- It is never recommended to splice/share signal wires (such as TPS, etc.) between different electronic control units (i.e. “piggyback”).
- Do not connect the red/white switched +12V wire to “dirty” sources, such as the ignition coil, audio systems, or 12V sources connected to HID head lamps.

8.0 WIRING HARNESS INSTALLATION

8.1 Main Power/Battery Connection

The TERMINATOR X™ ECU has a main battery power and ground connector on the right side of the ECU. The right position, Terminal “A” is the ground (black wire). The black wire should go to the negative post DIRECTLY on the battery. The left position, Terminal “B” is the positive terminal (red wire). The red wire should go to the positive post DIRECTLY on the battery. If you have a “dual post” battery, it is a great idea to purchase separate posts/studs to connect the ECU power and ground to the non-used terminals. Always use the fused power cable with the proper connectors supplied by Holley only. **Don't connect to the ECU until after ALL wiring and installation is performed.**



Figure 4

9.0 PRIMARY HARNESS INSTALLATION AND SENSOR CONNECTIONS

These sections review the Main Harness installation and sensor connections that must be completed. The Main Harness is the primary harness that supports all the primary engine sensors, fuel and ignition. There are two main connectors for this harness that plug into the ECU.

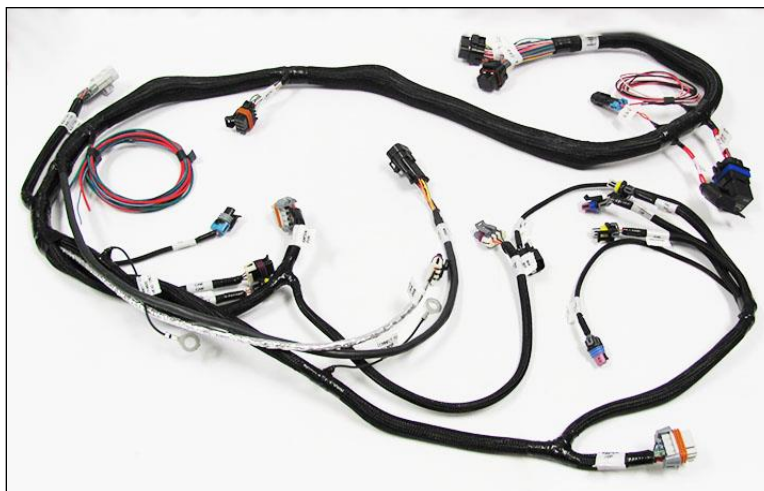

Figure 5

9.1 ECU Connectors

TERMINATOR™ X ECU – The TERMINATOR™ X ECU has **two** main connectors:

- **J1A** - The first connector next to the USB connector is the “J1A” connector (34 pin). This connector is primarily an “Input” connector. It contains all the sensor inputs and wide band oxygen sensor control.
- **J1B** - The second connector is the “J1B” connector (26 pin). This connector is the “output” connector. It has 8 injector outputs and outputs for other devices.
- **J3** – Connection point for the Drive-By-Wire harness (X Max Only).
- **J4** – Connection point for the Transmission harness (X Max Only).



Figure 6



Figure 7

9.2 Harness Routing

Note: Some kits also include harness specific instructions with more details about harness routing, connectors, etc. Please refer to those instructions for more information.

If the ECU is mounted in the interior, it will have to be routed through the firewall into the engine compartment. Use a 2" hole saw to create a hole in a desired location if no other point of access is available. Use a grommet for a 2" hole to seal this area. Holley recommends Earl's part number 29G001ERL.

If the ECU is mounted in the engine compartment, the 3.5" Touch Screen cable will have to be routed to the “CAN” connector on the main harness (located near the ECU connector main connector). This is assuming you want to access the hand-held module after startup. This will require routing the small CAN connector somewhere through the firewall.

Connect the J1A and J1B connectors of the main harness into the ECU.

A 40A Relay is located on the main harness. This powers the injectors and fuel pump. There is also a 20 amp fuse for the injectors and fuel pump pre-installed in this location.

9.3 Sensor Connections & Outputs

The following indicates the primary sensors that are required to be connected. Each connector on the main harness is labeled with the sensor name. The name on this label for each sensor is in parenthesis below.

Note: Some of the connector images shown below may not be the same as the connector on your harness. See the separate harness instructions included with your kit for more information.

9.3.1 Oil Pressure Sensor

[Optional] This connector will connect to some factory Oil Pressure sensors on LS applications, located at the rear of the engine. For other applications, utilize the Holley 554-102 0-100 psi transducer Note: LS2 GTO & F-body Oil Pressure sensors have a unique pin-out and cannot be used with the Terminator X Harness



Figure 8 Oil Pressure

9.3.2 Coolant Temperature Sensor (CTS)

[Required] Connect the CTS connector to the sensor which should be installed in a coolant passage in either the intake manifold or cylinder head. Do not install the sensor in the thermostat housing.



Figure 9 CTS

9.3.3 Wide Band Oxygen Sensor (WBO2)

[Required] Connect to the oxygen sensor previously installed. There is an adapter harness included in the kit which allows the Bosch 4.9 sensor to plug into the main engine harness. If you need an extension cable, one is available from Holley (P/N 534-199). The TERMINATOR X™ systems are intended to be used with a Bosch LSU 4.9 wide band oxygen sensor supplied by Holley. Service part number 554-155.

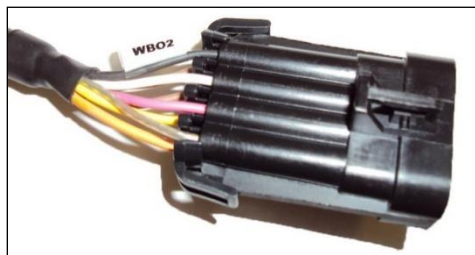

Figure 10 WBO2



Figure 11 WBO2

9.3.4 Fuel Pressure (Fuel)

[Optional] A fuel pressure transducer connector is pre-installed in the main harness. The system is plug-and-play configured for a Holley 100 PSI pressure transducer (can be purchased under PN 554-102). If these are not connected to a pressure transducer, the Fuel Pressure shown on the hand held display will not be accurate. This will not cause any issues. Connect to the transducer (if installed).

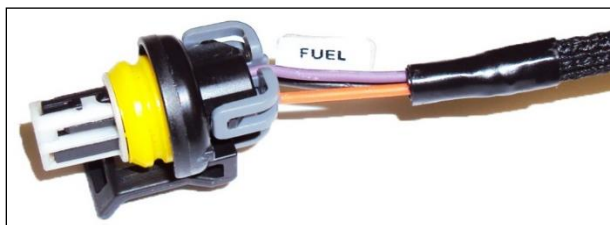

Figure 12 Fuel Pressure

9.3.5 Manifold Air Temperature (MAT)

[Required] Connect to the MAT sensor. Sensor should be placed somewhere in the intake manifold.

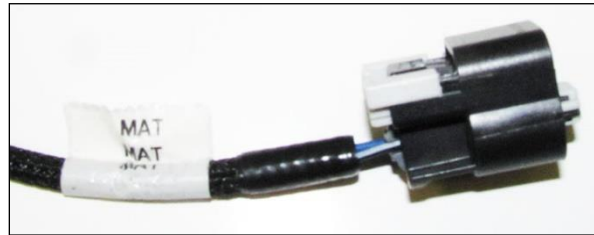

Figure 13 MAT

9.3.6 Ignition / Crank and Cam Sensors

The ignition connector shown in **Figure 14** is present on some harnesses, while others may have separate cam and crank sensor connectors instead. If your harness has separate cam and crank sensor connectors, simply plug them in to the proper sensors according to the labels on the harness.

There are several ignition adapters that will plug in directly to this connector. The part numbers are listed in the **Ignition Wiring Diagrams** section at the end of this manual.

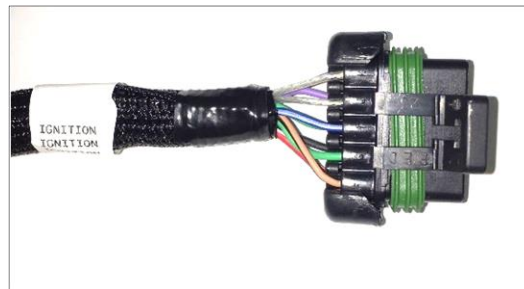

Figure 14 Ignition

See the **Ignition Wiring Diagrams** section at the end of this manual for the following wiring diagrams:

<u>Does NOT Control Ignition Timing</u>	<u>Controls Ignition Timing</u>
"Coil -" Engine Speed Input	GM Small Cap HEI Computer Controlled Distributor
"CD Box (Tach Out)" Engine Speed Input	GM Small Cap HEI Computer Controlled Distributor w/ CD Box
	Ford TFI Computer Controlled Distributor
	Ford TFI Computer Controlled Distributor w/ CD Box
	MSD Pro-Billet Distributor w/ CD Box
	Holley EFI Dual Sync Distributor w/ CD Box
	Holley Sniper EFI HyperSpark Distributor w/ CD Box

NOTE: For GEN 3 HEMI applications using a 558-116 harness you **MUST** use a Chrysler 514-9230-AA crank sensor. This sensor **MUST** be used when utilizing a 60-2 Ignition Strategy. This sensor is standard on 2009-12 Chrysler/Dodge/Jeep applications and is a direct replacement in 2013+ engines. See comparison image below.



APPROVED

DO NOT USE

9.3.8 Knock Sensors

[Not present on all harnesses] Connect to the Knock Sensor(s). Knock Sensors are not enabled in Terminator X base calibrations, but may be configured by using Terminator X software.



Figure 15 Knock

9.3.9 Manifold Absolute Pressure sensor (MAP)

[Required] For naturally aspirated & nitrous engines, you can connect the internal 1Bar MAP sensor located on the ECU to an available intake manifold port by using the appropriately sized quick-turn adapter.

Other MAP sensors can be used by plugging the MAP sensor connector into the sensor, or using an adapter harness (see part numbers in the note below). The following sensors can be configured using the wizard in the Terminator X handheld:

<u>Naturally Aspirated & Nitrous</u>	<u>Turbo and Supercharger</u>
Internal 1bar	GM PN 12592525 2.5 bar
Holley 1bar (538-24)	Holley 2bar (538-13)
Holley 1bar SS (554-133)	Holley 3bar (554-107)
	Holley 3.5bar SS (554-134)
	Holley 5bar SS (554-108)

MAP sensors not listed above can also be used, but they must be configured in the Terminator X software.

Note: The max manifold pressure supported by the handheld base calibrations is 250 kPa (21.6 psi boost).

Note: The following plug and play MAP adapter harnesses are available:

- MPFI to Holley SS MAP Adapter Harness – 558-466
- LS1/2 to Holley SS MAP Adapter Harness – 558-467
- LS1/2 to LS3 MAP Adapter Harness – 558-416

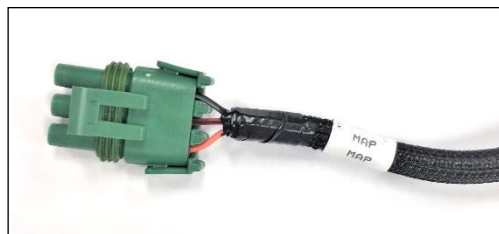

Figure 16 MAP

9.3.10 Throttle Position Sensor (TPS)

[Required] Connect to a cable driven throttle body.

Note: This connector is not used with a Drive-By-Wire throttle body.



Figure 17 TPS

9.3.11 Idle Air Control (IAC)

[Required] Connect to a cable driven throttle body.

Note: This connector is not used with a Drive-By-Wire throttle body

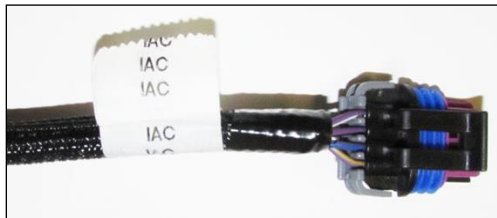

Figure 18 IAC

9.3.12 Fuel Injectors

[Required] All terminated harnesses have a fuel injector connector. Various fuel injector harnesses plug into this connector. It is essential the correct harness for your application is used so the proper injector firing sequence is maintained.

Note that for engines with different firing orders, you do NOT change these pins. The engine's firing order is input in the software itself. Pin's A-H are routed to the cylinder number designation for the engine (i.e. A goes to cylinder #1, B goes to cylinder #2, etc). V8 harnesses offered by Holley are labeled for GM, Ford, and Chrysler engines.

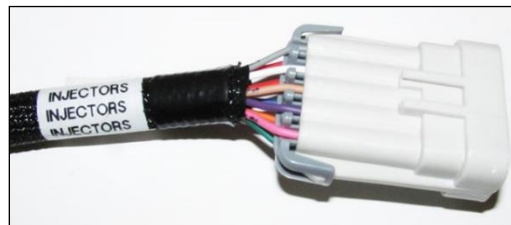

Figure 19 Fuel Injectors

NOTE: Make sure to connect each injector connector (numbered) into the appropriate fuel injector otherwise severe engine damage may occur.

NOTE: There are multiple styles of injector connectors. An overview of these various connector styles can be found in Appendix 2.0 of the full Terminator X instruction manual found. If the harness supplied in your kit does not match what your engine has, please contact Holley Tech Service.

9.3.13 Ignition Coils

[Not present on all harnesses] Connect the coil connectors into each bank of coils. The driver side connector should be labeled "DIS CONNECTOR ODD" or have the corresponding cylinder numbers. The passenger side connector should be labeled "DIS CONNECTOR EVEN" or have the corresponding cylinder numbers. Make sure these are plugged in correctly. If they aren't, the firing order will not occur properly and damage could result.

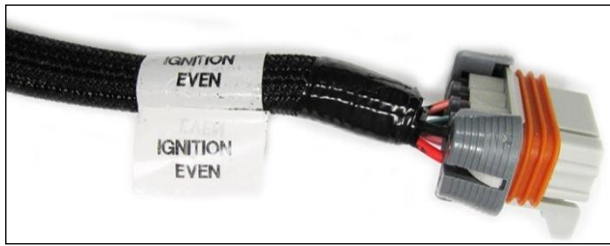

Figure 20 Ignition Even

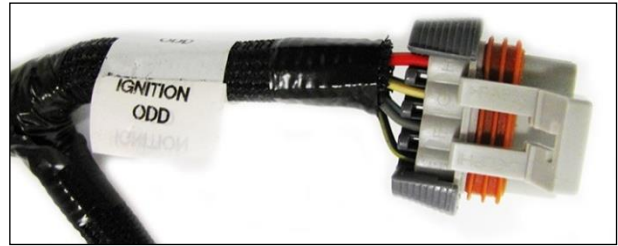

Figure 21 Ignition Odd

9.3.14 Coil Ground Wires

[Not present on all harnesses] There are two coil ground wires. These are labeled “CONNECT TO CYLINDER HEAD ONLY!” There is one on each bank of the engine. They are black wires and have an eyelet crimped on them. These are to be fastened to the rear of each cylinder head. These **MUST** be installed and **MUST** be installed to the head securely. If not, the coils will not be grounded and the engine will run poorly and other issues will occur.



Figure 22 Coil Ground Wires

9.3.15 Handheld Connections - (CAN1)

[Required] The handheld controller is used to create an initial calibration for the system, allows for simple tuning changes to be performed, and is also used to view various information of the EFI system. It should be installed such that the handheld controller can be easily used in the passenger compartment. The handheld plugs directly into the main harness at either connector labeled “CAN”. The handheld does not have to remain in the vehicle or utilized after the vehicle is set up and running properly.

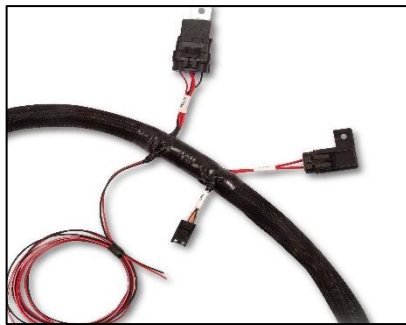

Figure 23 Handheld Connection



Figure 24 Handheld

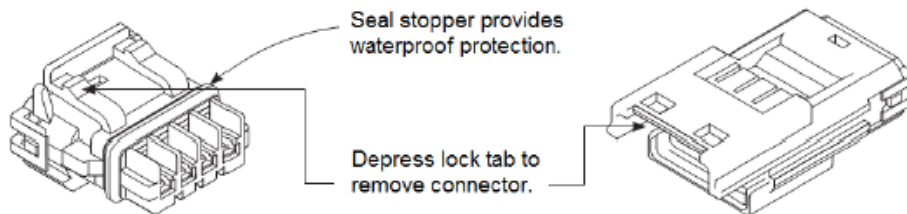

Figure 25 – Handheld CAN connector

10.0 LOOSE WIRES



Figure 26

The following loose wires in the main wiring harness should be connected as follows on all systems.

[Required] 12V Switched – Color = Red/White – Should be connected to a clean +12 volt power source. Power source should only be active when the ignition is on. Make sure source has power when engine is cranking as well (check with voltmeter). Not all sources apply power when the ignition switch is in “cranking” position. This wire is located approximately 7” from the ECU connectors. **DO NOT connect to a “DIRTY” source like an ignition coil!**

[Required] 12V Battery – Color = Red – Should be connected directly to the battery. This powers the fuel pump and fuel injectors. This wire is protected by a fuse in a sealed fuse holder. The fuse holder is located about 18” from the ECU connector. A fuse is pre-installed (20A).

[Optional] 12V Fuel Pump – Color = Green - Used to directly power a fuel pump (+12 volt). **Do not use this wire to power fuel pumps that require over 15 Amps.** Refer to your fuel pump manufacturer for amperage ratings. For high current pumps, use this wire to trigger a separate relay and use larger gauge wire to feed the pump - 10 gauge is recommended.

[Required] Chassis Ground – Color = Black – Connect to a chassis ground point that has excellent connectivity with both the engine and battery. There must be good continuity between the connection point and the battery when checked with a digital volt ohm meter (DVOM). This ground should not be connected at the same location as other grounds.

[Optional] Points Output – Color = White – Used to trigger a CD ignition box in certain applications. This will not be used with a TFI distributor. If using a TFI distributor and a CD ignition box, you will connect the white points output wire from the **TFI adapter harness** to the CD box. See ignition wiring diagrams at the end of this manual. **Note:** This loose wire is not present on all harnesses.

[Optional] Tach Output – Color = Blue with white stripe – This wire provides a 12v square wave output and can be used to trigger a conventional tachometer. **Note:** This loose wire is not present on all harnesses.

[Optional] “Coil – ” – Color = Yellow – Used for an RPM input signal when not controlling timing and NOT running a Capacitive Discharge (MSD) ignition system. **Note:** This loose wire is not present on all harnesses

11.0 ADDITIONAL INPUTS & OUTPUTS

Terminator X base calibrations from the wizard in the handheld are pre-configured with 3 outputs and 1 input to be used for the following features:

- Electric Fan #1 output (Ground)
- Electric Fan #2 output (Ground)
- Air Conditioning Shutdown at wide open throttle (Ground)
- A/C Kick input (Ground)

The chart below will help identify the proper loose wires necessary for use with the preconfigured inputs/outputs, as well as additional inputs/outputs that can be configured in the software. These are located in the “Inputs/Outputs” connector (**Figure 27**). A mating harness with loose wires is included with the system (**Figure 28**).

Preconfigured Input/Output Wiring			
Description	ECU Pin	Connector Pin	Loose Wire Color
A/C Kick (Input #1)	A12	A	White w/ Blue
Input #2	A3	B	White w/ Red
Input #3	A13	C	White w/ Black
Input #4	A4	D	White w/ Green
Electric Fan #1 (Output #1)	B12	E	Gray w/ Yellow
Electric Fan #2 (Output #2)	B11	F	Gray w/ Red
A/C Shutdown (Output #3)	B10	G	Gray w/ Black
Output #4*	B3	H	Gray w/ Green

*Applications using an OEM style Ford IAC (PWM-) use one of the Terminator X outputs (Output #4) to control the IAC. If using the Fox Body Mustang Harness (PN 558-128), Output #4 is already connected from the ECU to the IAC connector. Be sure to select the proper IAC when setting up the calibration in the handheld.

The following indicates proper wiring for these features:

Electric Fan #1 output – This output will provide a ground output to trigger a relay used for a cooling fan. This output should never be directly connected to a fan, but the relay that powers the fan. It should be connected to the ground trigger of the relay.

Electric Fan #2 output – This output will provide a ground output to trigger a relay used for a cooling fan. This output should never be directly connected to a fan, but the relay that powers the fan. It should be connected to the ground trigger of the relay.

A/C Shutdown – This output will provide a ground output at a defined throttle position. If desired, this throttle position can be changed using the software. This output can be used to trigger a relay that deactivates the A/C at higher throttle positions. This may require the installation of a 5 pole relay in the existing A/C wiring.

A/C Kick input – This ground input will allow for the Idle Air Control motor to automatically make an increase in IAC %, which is necessary to avoid a momentary drop in idle speed when the A/C compressor turns on.

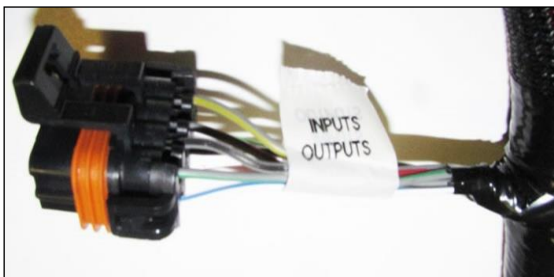

Figure 27



Figure 28

12.0 TRANSMISSION HARNESS

12.1 GM Transmission Wiring

The 558-405 GM transmission harness can be used on 4L60E, 4L65E, early 4L70E, 4L80E, and 4L85E transmissions. Each connector should be labeled.

Connectors

ECU Connector (J4) – Plugs into the ECU. Plugs into the last connector opposite the main harness.

Main Transmission Connector – Simply plugs into the connector on the transmission. Located on the driver's side of a 4L80E (installed horizontally) and the passenger side on a 4L60E (installed vertically).

Vehicle Speed Sensor (VSS)/Transmission Output Speed Sensor (OSS) – Located on the rear drivers side on a 4L80E and the rear passengers side on a 4L60E

Turbine Speed Sensor – The 4L60E does not have a turbine speed sensor. It is located towards the front driver's side on a 4L80E. Note that a 4L70E has one internally wired, but is not connected to the Holley harness. The turbine speed sensor is not used for any calculations in the ECU, just for monitoring purposes.

Loose Wires

Brake Switch (Grey) – Wired to the brake light switch. This must be installed to a +12v source (as most brake light switches are). This input is used to unlock the torque converter when the brakes are applied.

Ground (Black) – Connect to a good chassis/engine ground source

Power (Red) – Supplies power to the transmission solenoids. This should be connected directly to the battery, or a constant battery source capable of supplying 5 amps.

Switched Power (Red/White) – This should be connected to a +12v switched power source and is used to trigger the relay

NOTE: The power supplying this wire must **NOT** be tied to the same point that the ECU switched power wire (red/white wire) is connected to. If they are tied together, the transmission power could back-feed power to the ECU and the ECU/engine will not shut off when the key is turned off. Use a relay or separate switched ignition power pickup point to supply power to the transmission harness.

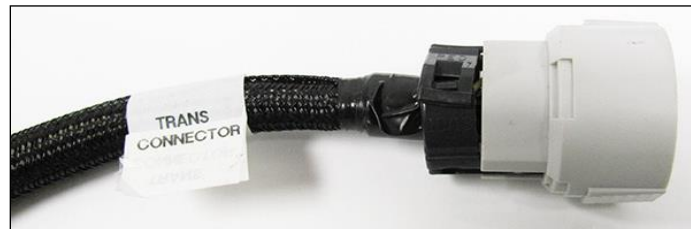

Figure 29 - Main Transmission Connector



Figure 30 - Vehicle Speed Sensor



Figure 31 - Turbine Speed Sensor



Figure 32 - Transmission & ECU Connector



Figure 33 - Loose Wire Bundle

12.2 Ford Transmission Wiring

There are two different Ford transmissions harnesses, depending on the application:

- 1.) AODE and 4R70W transmissions from 1992 until 1997
- 2.) 4R70W and 4R75W transmissions from 1998 and up

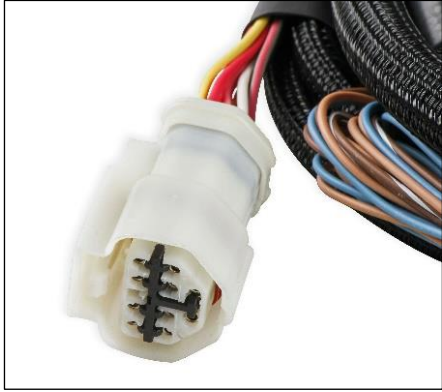

Figure 34 - Main Transmission Connector
AODE/4R70W 92-97



Figure 35 - Main Transmission Connector
4R70W/4R75W 98+

Connectors

ECU Connector (J4) – Plugs into the ECU. Plugs into the last connector opposite the main harness.

Main Transmission Connector – Simply plugs into the connector on the transmission.

Transmission Range Connector – Plugs in at the manual lever on the transmission. The loose wires are for various car features and are listed later in the instructions.

Vehicle Speed Sensor (VSS)/Transmission Output Speed Sensor (OSS) –

92-97 Harness: Plugs in to the speed sensor located on the tailshaft of the transmission.

98+ Harness: Two short jumper harnesses are included – select the correct one for your application based on the sensor's connector shape.

Pressure Transducer (optional) – The harness is supplied with a prewired pressure transducer connector. This can be used to monitor transmission line pressure if desired. The input will need to be configured for the sensor used in the I/O and then mapped to J4-B21. A Holley 0-500psi sensor (554-136) is recommended.

Loose Wires

Brake Switch (brown/white) – Wired to the brake light switch. This must be installed to a +12v source (as most brake light switches are). This input is used to unlock the torque converter when the brakes are applied.

OD Cancel (tan) (optional) – Use this wire on a momentary switch to disable/enable overdrive. This must be installed to a +12v.

OD Status (light blue) (optional) – Hook this to the ground side of an LED to indicate if OD Cancel is active.

Reverse Lights (violet) – Pass through circuit for reverse lamp activation.

Neutral Safety Switch (white) – Pass through circuit for starter solenoid.

4x4 Module (black/white) (optional) – Pass through circuit for 4x4 modules.

NOTE: Refer to factory manuals in order to wire these functions into factory vehicles equipped with these functions.

13.0 DRIVE-BY-WIRE HARNESS

13.1 Overview

The Terminator X Max ECU has built-in capability to control OEM type Drive-By-Wire throttle pedals and throttle bodies for aftermarket installation.

To ensure a safe and reliable installation, there are certain hardware requirements that **must** be followed:

See Appendix 3.0 in the full Terminator X instruction manual found for a listing of factory drive-by-wire throttle bodies and pedals that have been pre-calibrated and approved for use with this harness

13.2 Warnings!

Use only the drive-by-wire wiring harness supplied by Holley. THIS HARNESS CAN NOT BE CUT, SHORTENED, LENGTHENED, TAILORED, OR MODIFIED UNDER ANY CIRCUMSTANCE! THE HARNESS CONTAINS PROTECTIVE SHIELDING / GROUNDED CABLING TO ENSURE PROPER OPERATION. DO NOT REMOVE OR MODIFY THE PROTECTIVE SHEATHING UNDER ANY CIRCUMSTANCES. HOLLEY ASSUMES NO LIABILITY FOR ANY INSTANCES ARISING DUE TO USE OF THROTTLE PEDALS, THROTTLE BODIES OR ASSOCIATED COMPONENTS NOT SPECIFICALLY APPROVED BY HOLLEY.

13.3 Installation

Installation of both the drive-by-wire throttle body and pedal assembly should be performed by a professional, competent mechanic. It is important that the installation of both the throttle body and pedal assembly on an engine (not originally equipped with these components) be done in such a manner that assures proper operation of both components as intended by the OEM manufacturer.

- The throttle body must be installed in such a manner that the throttle plate(s) are allowed to rotate freely.
- The pedal assembly must also be installed in such a manner that it is rigidly and securely mounted, yet does not put the pedal in a bind, or put any mechanical stress on the electrical and electronic components. Proper positioning of the pedal is of the utmost importance.
- The accelerator pedal must have adequate clearance throughout the range of its travel to prevent the possibility of the pedal coming in contact with any item that may cause it not to return to the "idle" position upon release. The accelerator pedal must also be mounted far enough away from the brake pedal as to allow for the vehicle's brakes to be fully applied without the operator's foot coming in contact with the D-B-W pedal.
- The drive-by-wire pedal should be in a position such that it is lower than the brake pedal when the brake pedal is depressed.
- Installation of the wiring harness supplied by Holley must be done so that there is no chance the wiring may be cut or abraded. Rubber grommets should be utilized wherever the harness passes thru a firewall / sheet metal panel.
- The DBW harness should never be routed in such a manner that it may come in contact with "noisy" electrical components or wiring that may emit RFI and/or EMI noise. Typical "noisy" components and associated wiring in a vehicle would be spark plug wires, ignition coils, high energy ignition boxes, two-way radios (including CB's), etc. Maintain a minimum of 5" of clearance to any of these types of components.

The harness is designed to be "plug-and-play" with the throttle bodies and pedal assembly indicated above. It should not be used for any other applications.

13.4 System Safeties

Holley designed the drive-by-wire system to utilize a brake pedal switch input. This is wired to a +12v input from the brake pedal switch. If the brake pedal is depressed enough to activate the brake light switch, the following occurs:

- The ECU will not allow a throttle position over 10%, no matter how far the pedal is pushed. This consequently limits the opening of the throttle body.

Before a pedal value over 10% will be recognized, the following must occur in this order:

- Brake pedal switch must be released
- Pedal position must go below 10%

- Fuel flow is limited to 30 lb./hr. as an additional safety.

IMPORTANT! INSTALLATION OF THIS SAFETY CIRCUIT IS REQUIRED WHEN USING THE DRIVE-BY-WIRE FEATURE! DEFEATING OR NEGLECTING TO INSTALL THIS INPUT IS DONE SO AT THE USERS OWN RISK. THE USER ASSUMES ANY AND ALL LIABILITY FOR ANY DAMAGE, AS A RESULT OF A DRIVE-BY-WIRE MALFUNCTION.

Most drive-by-wire systems are designed so there are two position sensors on both the throttle body and the accelerator pedal assembly. This is done as a failsafe in the event that one of the position sensors should fail. Holley EFI systems require that both sets of sensors are functioning 100% properly. If any sensor moves from its calibrated position, the throttle body is immediately de-powered, forcing it to move to the factory “limp home” position. The “limp home” position is described in detail below. Whenever a fault is detected and the throttle body is de-powered, a fuel flow limit of 30 lb./hr. is also introduced.

13.5 Throttle Body “Limp Home” Position

Factory Drive-By-Wire Throttle Bodies have a “Limp Home” position. This is the position that the throttle body is at when no power is applied. It is typically enough air flow to allow a car to move at a speed of approximately 45 mph.

It should be strongly noted that this position allows MORE airflow than the engine uses for an idle position. If the throttle body goes into a “limp home” position due to a sensor failure or other reason, the engine will have more air and result in more power. This will require more brake pressure to be applied if a vehicle is in gear so that it does not move.

13.6 Drive-By-Wire DO’S and DON’TS

DO

- Use only the Holley supplied harness.
- Have the pedal, throttle body, and harness installed by a competent professional.

DON’T

- Do not use wire other than the Holley supplied harness.
- Do not cut, shorten, lengthen, or otherwise modify the drive-by-wire harness for any reason!
- Do not run drive-by-wire harness past high voltage or “noisy” sources
- Do not use this system if the pedal is not securely mounted as described in the instructions above. It must be **SOLIDLY** mounted with adequate room for safe and proper operation.
- Do not use this system if the throttle body is not properly mounted or has any potential of interference/binding of the throttle plates.
- Do not start the engine unless everything is operating properly.

13.7 GM DBW Wiring

Golden Rule: These are plug-and-play harnesses. If they don’t plug, don’t play.

LS Engines came with two styles of connectors for their DBW throttle bodies; An 8 pin connector (early truck) and a 6 pin (passenger car and 2007+ truck) Appendix 3 of the full Terminator X instruction manual found contains more details and Holley supported part numbers for throttle bodies and throttle pedals and their associated harness part numbers.

ECU connector – plug into location J3 (See Section 9.1 – ECU pic)

Pedal Connector – plug into the throttle pedal

Throttle Body Connector – plug into the DBW throttle body.

Brake Switch Wire – This **MUST** be connected to a +12v input from the brake pedal switch.



Figure 36

13.8 Ford DBW Wiring

Golden Rule: These are plug-and-play harnesses. If they don't plug, don't play.

Only the factory drive-by-wire throttle body has been pre-calibrated and approved for use with these harnesses. Some applications have different connectors, have not been tested, and are therefore not approved for use with the Holley ECU.

The 558-422 DBW harness is made for compatibility with the stock pedal assembly. The BR3Z-9F836-D is a pedal with a black plastic face whereas the BR3Z-9F836-C has a metal finish pad.

This harness is made for compatibility with the stock throttle body assemblies. BR3Z-9E926-C, BR3E-9F991-AB, and FR3E-9F991-AA are acceptable. Earlier software versions will not have these part numbers listed in the throttle body type, however it is acceptable to use the "Ford PN 7R3Z 9E926-AA" to control the BR3Z-9E926-C or BR3E-9F991-AB throttle bodies.

ECU connector – plug into location J3 (See Section 9.1 – ECU pic)

Pedal Connector – plug into the throttle pedal

Throttle Body Connector – plug into the DBW throttle body.

Brake Switch Wire – This **MUST** be connected to a +12v input from the brake pedal switch.

13.9 Chrysler DBW Wiring

Golden Rule: These are plug-and-play harnesses. If they don't plug, don't play.

The 558-417 DBW harness is made for compatibility with the 0486 1708 pedal assembly and specifically a Chrysler 0459 1847 factory drive-by-wire throttle body. This was used up to approximately 2007 in the car applications. Some earlier truck applications have different connectors and the DBW actuators have not been tested and are therefore not approved for use with a Holley ECU.

The 558-418 DBW harness is made for compatibility with the 0486 1714 pedal assembly and specifically a Chrysler 0459 1847 factory drive-by-wire throttle body. This was the later style of pedal. Some earlier truck applications have different connectors and the DBW actuators have not been tested and are therefore not approved for use with a Holley ECU.

The 558-437 DBW harness is made for compatibility with the 0486 1714 pedal assembly and specifically a Chrysler 53034251AB factory drive-by-wire throttle body.

ECU connector – plug into location J3 (See Section 9.1 – ECU pic)

Pedal Connector – plug into the throttle pedal

Throttle Body Connector – plug into the DBW throttle body.

Brake Switch Wire – This **MUST** be connected to a +12v input from the brake pedal switch.

14.0 FINAL ECU CONNECTION

Once all harnessing has been connected, you may plug in the main power harness (referenced in section 9.1) to the ECU.

At this point, the installation of your EFI system should be 100 percent complete. The ECU, TERMINATOR X™ Handheld controller, throttle body and intake hardware, all sensors, wiring, fuel pump, regulator and return line, and all other hardware should be installed. The vehicle should be ready to start and run. If this is not the case, refer to the hardware installation manual included with your particular system.

15.0 TERMINATOR X™ INSTRUCTIONS AND TUNING

The TERMINATOR X™ EFI systems are designed to be easy to use for the first time EFI tuner. The instructions are set up in that manner as well. These instructions will not get into detail about EFI theory and operation. They will provide the steps necessary to get you up and running quickly. The TERMINATOR X™ system allows for the user to perform some basic changes to the tuning *if they desire to do so*. The instructions are sequenced to get you up and running so you can enjoy your vehicle, then review some of the parameters that can be adjusted to fine tune your vehicle at a later time if desired.

16.0 INITIAL POWER-UP

Turn the ignition key to the “run” position. This should apply power to the ECU as well as the TERMINATOR X™ Handheld control module. The handheld should power up and the Home Screen (Figure 37) should appear.

The Home screen contains icons which will navigate to different functional features of the 3.5 Touch Screen. These features will be discussed in detail throughout this manual.

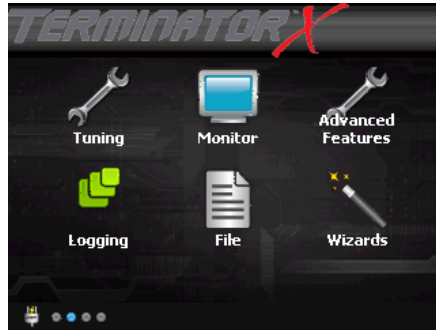

Figure 37 – Home Screen

NOTE: DO NOT ATTEMPT TO START THE VEHICLE UNTIL YOU ARE TOLD TO DO SO IN THE INSTRUCTIONS BELOW.

NOTE: The handheld has an SD memory card installed in the side. This card contains specific information that is required for the use of the TERMINATOR X™ product. DO NOT replace this card with another. There should be no need to remove this card for normal use.

17.0 HANDHELD NAVIGATION & USE

The 3.5” handheld utilizes a touch screen display. All navigation is done through “touching” an icon or button on the screen. The following is an overview of the different types of adjustment screens that are used in the display, and that may be utilized when tuning or making selections.

17.1 Making Adjustments

Slider Bar: Slide the bar left or right with the stylus, or use the right and left arrow keys for fine adjustment (Figure 38).

List: Use the scroll bar on the right hand side of the screen to view all list entries. Touch the desired list item and click ‘OK’ to make a selection (Figure 39).



Figure 38 – Slider Bar

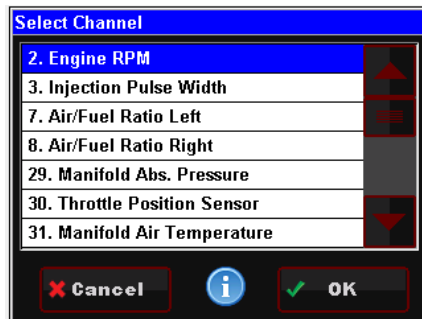

Figure 39 – List

Radio Button: Touch the desired list item to select it (Figure 40).

On Screen Prompts: Follow the on screen text and use buttons at the bottom of the screen to continue or confirm (Figure 41).



Figure 40 – On Screen Prompts

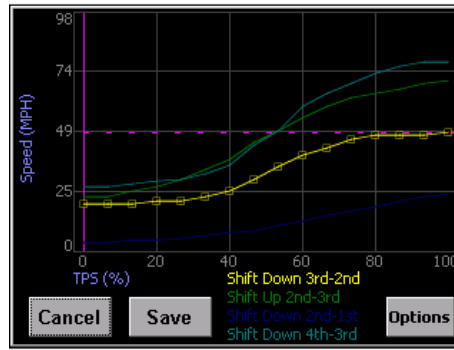

Figure 41 – Graph

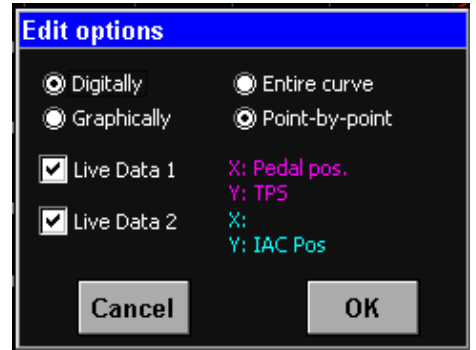

Figure 42 – Edit Options

Digitally: Selecting this option enables slider bar adjustment of individual data points on the graph or the entire curve.

Graphically: Selecting this option enables single point or whole curve adjustment. A stylus may be used to select and drag data on the graph screen.

Entire Curve: Selecting this will 'lock' all the data points together allowing the entire curve to be shifted up or down

Point by Point: Selecting this will allow point by point curve adjustment for fine tuning.

Live Data 1 & 2: This will enable live telemetry on the graph screen making fine tuning easier.

18.0 HOME SCREEN

The HOME SCREEN has 6 selections (**Figure 43**). They are explained in more detail later in the instructions.

TUNING – Allows for various parameters to be easily adjusted.

MONITOR – A variety of gauge and dash displays.

ADVANCED FEATURES – Advanced / Power Adder tuning

LOGGING – Start, Stop, and Configure Data Logs

FILE – Saves and loads calibrations. Also shows information about the ECU and handheld controller.

WIZARDS – Creates a base calibration and performs the TPS Autaset function.

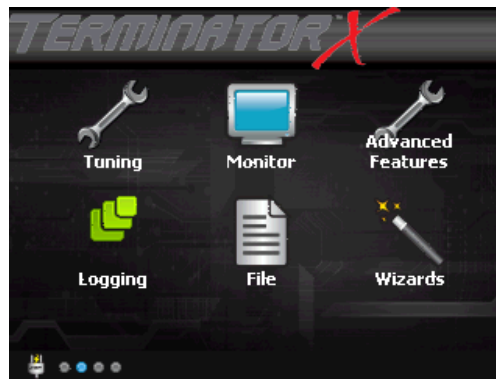
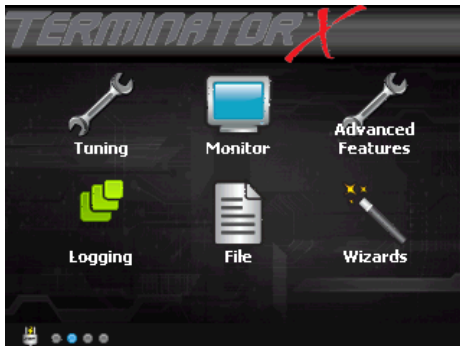

Figure 43

19.0 CALIBRATION WIZARD



The Terminator X system will build a custom calibration for your engine based on a few easy to answer questions. To begin, Choose the Wizards icon from the main menu.



Choose the GCF Wizard icon.

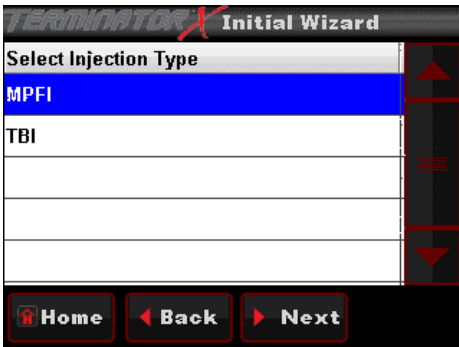

Choose MPFI (Multi Port Fuel Injection) as the system type.

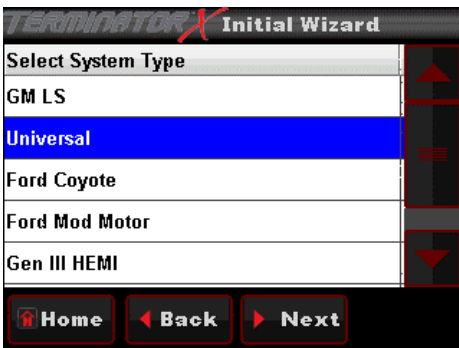

Choose proper system type if listed, otherwise choose "Universal".

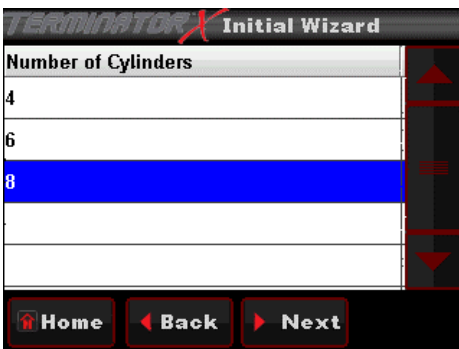

Choose the number of cylinders - 4, 6, & 8 are options.

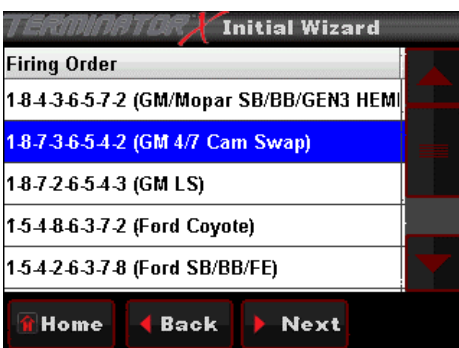

Choose the correct firing order. Use the scroll bar on the right to view all options.



Choose the unit of measure you would like to use to enter the engine size.



Use the slider bar to enter your engine size.



Use the slider bar to set your desired HOT idle speed.

Tip: The Terminator X system will target this idle speed when coolant temp is above 160° F



Make a selection that matches the cam specs of your engine.

Tip: If you do not know your exact camshaft specs, choose selection #1

Tip: Closed Loop operation is disabled below 2500 RPM when #3 is chosen. This can be modified per your needs via the included 3.5" handheld

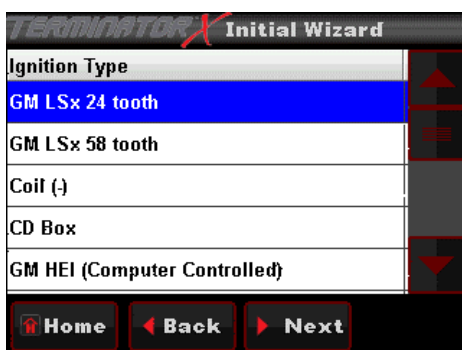

Choose your ignition type:

- GM LSx 24 tooth
- GM LSx 58 tooth
- Coil (-)*
- CD Box (Tach Out)**
- GM HEI (Computer Controlled)
- Ford TFI 8 Cylinder Sequential
- Sniper HyperSpark Distributors
- Holley Dual Sync Distributor
- Magnetic Pickup Distributor

Tip: The kit & engine harness you purchased must match your application.

*Terminator X does NOT control ignition timing

**Connected to Tach Output on CD Box, Terminator X does NOT control ignition timing



Choose the appropriate fuel pressure.

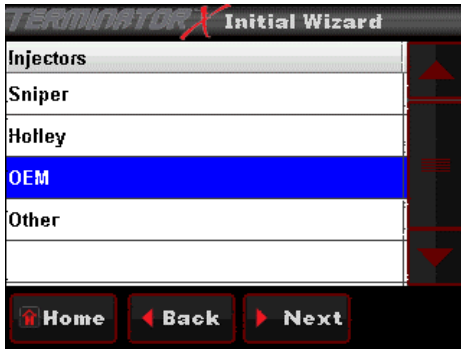

Choose your brand/manufacturer of injector.

Each grouping contains a list of part numbers that are supported with the Terminator X system.

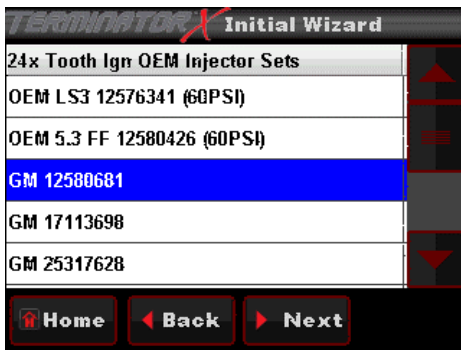

Choose the part number of injector that matches what is installed in your engine.

Tip: For proper operation, it is critical that the correct injector part number is selected

Tip: Injector data can be entered and modified via Terminator X software if your injectors are not listed.

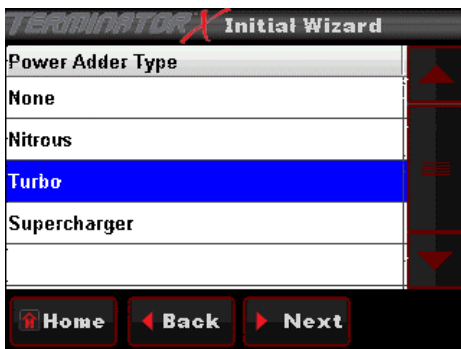

Choose your power adder type.

Tip: Users selecting naturally aspirated or nitrous during this step will skip to "Choose throttle body type" on the next page.

Naturally Aspirated & Nitrous

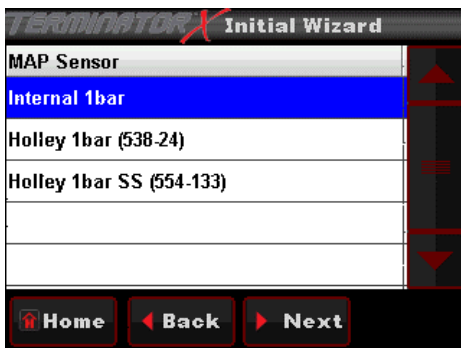

Turbo and Supercharger



Depending on your power adder type you will get these two options for MAP sensor.

Tip: Terminator X base calibrations require using one of the listed part numbers for a MAP sensor. Failure to do so may cause severe engine damage.

Tip: MAP sensors other than those listed may be configured via Terminator X software.

Note: The max manifold pressure supported by the handheld base calibrations is 250 kPa (21.6 psi) boost. If your application makes more boost, tuning with the PC software is required.



If a Turbo or Supercharger was chosen, use the slider bar to set desired wide open throttle (WOT) ignition timing **AT ZERO BOOST**

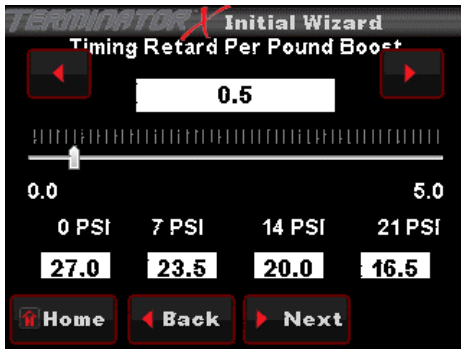

If a Turbo or Supercharger was chosen, use the slider bar to set desired timing retard per pound of boost.

Breakpoints of 7, 14 & 21 PSI are shown for reference



If a Turbo or Supercharger was chosen, use the slider bar to set desired wide open throttle (WOT) Air/Fuel Ratio (AFR) **AT ZERO BOOST**

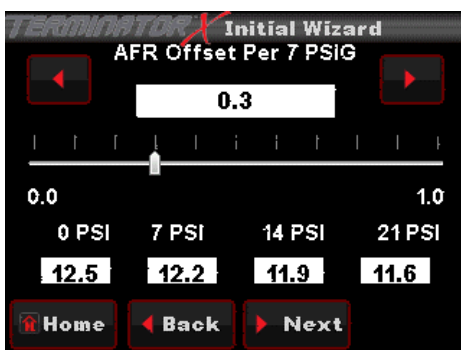

If a Turbo or Supercharger was chosen, use the slider bar to set desired AFR offset per 7 pounds of boost.

Breakpoints of 7, 14 & 21 PSI are shown for reference



Choose throttle body type (Terminator X Max only)

Select No if you are using a cable operated throttle body



If using a cable operated throttle body, choose IAC type.

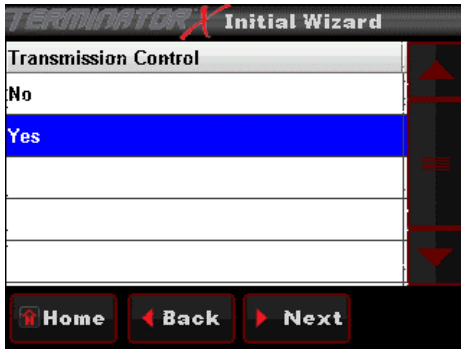

If you will be using the Terminator X system to control an electronic transmission (Terminator X Max only), choose Yes.

Choose no if you have an older non-electronic transmission (i.e. TH350, TH400, 700R-4, etc.) OR if you are using a separate standalone controller for your previously installed electronic transmission.



If transmission control was chosen in the previous step, Select the transmission type you will be controlling. The following options are available:

- 4L60/5E
- 4L70E
- 4L80/5E
- Ford AODE
- Ford 4R70W



Enter your tire diameter



Enter your gear ratio

Tip: Tire diameter and gear ratio must be entered correctly for proper transmission operation

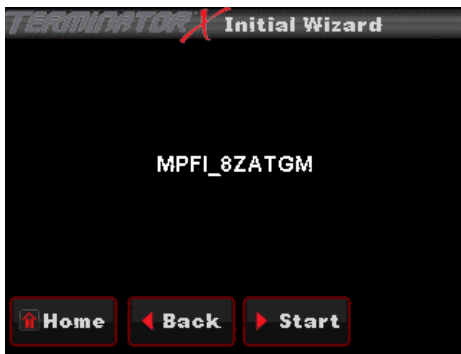

Select the Start button to upload the custom Terminator X calibration to your ECU.

Congratulations, you have completed the setup Wizard!

It is now time to perform a TPS Autaset

20.0 TPS AUTOSET

After completing the calibration wizard, the next step is to perform a “TPS Autaset”. **This must be done on a brand new system otherwise the injectors and ignition will not be fired by the ECU.** A TPS Autaset programs the ECU with the full travel/voltage range from idle to wide open throttle for the Throttle Position Sensor (TPS). This must be done with the vehicle ignition power on. The TPS Autaset function is found under the “WIZARDS” choice under the HOME SCREEN. Select “START TPS AUTOSET”. Follow the prompts. You can select “Home” at any point to stop the process. If everything is successful, you will see a TPS Autaset Successful message.



Step 1: Select TPS Autaset



Step 2



Step 3



Step 4: Select 'Done'

21.0 SENSOR VERIFICATION

Before starting the vehicle, verify that all of the sensors are reading properly. Turn the key off, and cycle it back on. At this time you should hear the fuel pump come on and run for 5 seconds. Check for fuel leaks.

On the HOME SCREEN, select the MONITOR tab. This will bring up various options. Select the “Monitors” screen. You will see a screen called “Initial Startup”. Select this. With the key on and the engine off, these sensors should read as follows:

- **Engine RPM** – Will show “Stall” when not cranking. Will show RPM once the engine is cranking or running
- **MAP** (Manifold Air Pressure Sensor) – Should read from 95-102. At high elevations it could read as low as 75.
- **TPS** (Throttle Position Sensor) – Slowly depress the throttle to wide open. It should read 100 at wide open throttle. Cable operated throttle bodies should read 0 closed.
- **CTS** (Coolant Temperature Sensor) – reads engine temperature. If the engine is “cold”, it should read close to ambient temperature.
- **Battery** – Will read battery voltage. Should be 12.0 volts minimum.

If ANY of these sensors are not reading properly DO NOT attempt to start the engine.

22.0 STARTUP

The vehicle should be ready to be started. Open the same sensors screen as in section 21.0. Make sure the TPS is reading 0. If it does not, do a TPS AUTOSET, or if it is reading 1-2%, close the idle screw on the throttle body slightly.

Crank the engine and look at the RPM parameter. It should change to “Syncing”, indicating the ECU is syncing with the RPM signal for an instant, then show an RPM signal. The engine should fire and run and come to an idle.

If you do not get an RPM signal, there is an error in the wiring or system setup. Call Holley Tech service for advice.

If the engine starts but is idling too low and appears to be struggling for air, refer to section 24.0 for cable operated throttle bodies.

23.0 AFTER-STARTUP

Once the vehicle has started, look for any fuel or coolant leaks. Let the vehicle warm up and look at some other parameters to make everything is operating properly. Go into the MONITOR, MONITORS, and select the “Closed Loop” icon.

- **Closed Loop Status** – Indicates whether the engine is “Closed Loop” or “Open Loop”. Closed Loop indicates that the ECU is adding or subtracting fuel to maintain the target air/fuel ratio. The TERMINATOR™ calibrations are such that the system should be operating closed loop almost all of the time.
- **Closed Loop Compensation** – This is the percentage of fuel that the ECU is adding or subtracting to maintain the target air/fuel ratio at any specific moment. A value with a minus (-) sign in front indicates the ECU is removing fuel. A value with no minus sign indicates the ECU is adding fuel. When in open loop operation, this will always stay at 0%.
- **Target Air/Fuel Ratio** – This is the target AFR (air/fuel ratio) the ECU is trying to maintain. This will vary depending on the engine speed and load.
- **Air/Fuel Ratio Left** – This will show the air/fuel ratio the wideband oxygen sensor is reading. The Closed Loop Compensation should be adding or subtracting fuel all the time such that the AFR Left should always be close to the Target AFR value. (Note ARF Right will only be active if a second sensor is being used which is not included).
- **Fuel Learn Status** – This indicates the status of the TERMINATOR™ “Self Tuning” operation (Learn Status). The system will automatically tune itself as you drive around. There are several conditions that must occur in order for the Self Tuning to occur. The engine temperature must exceed 160° F. The system must be operating in a closed loop mode, and the Self Tuning must be enabled. The base TERMINATOR™ setups have the Self Tuning enabled. Once the engine reaches 160° F, the Self Tuning should be active. The Learn Stat will show “NoLearn” when Self Tuning is not active and “Learn” if Self-tuning is active.

If any of these parameters are not showing a proper value, find out why before further driving the vehicle.

24.0 IDLE SETTING/CABLE OPERATED THROTTLE PLATE SETTING

Once the engine is up to operating temperature, the idle speed can be set to what is desired.

From the HOME SCREEN, select the TUNING tab. Then select the BASIC and then BASIC IDLE. You can see what the target hot idle speed is set to. If you are happy with the current value, use the BACK or HOME button to exit. If you would like to change it, click on the IDLE SPEED. This brings up a screen to adjust the idle speed (**Figure 44**). Move the button left and right to adjust it. Click the button to save the new value or select CANCEL at the bottom to move out of this screen.

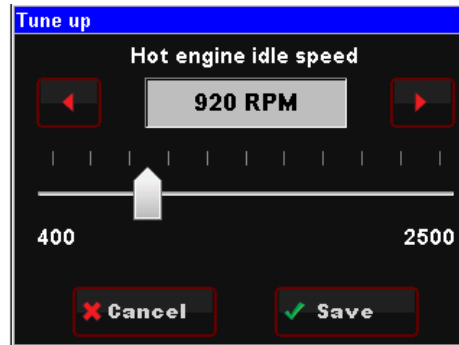

Figure 44

Whether you change the target idle or not, you need to set the throttle plates on the throttle body to an optimal position. To do so, with the engine running select the MONITOR tab. You will see the IDLE screen. Look at the "IAC Position" value. This value should be set between 2 and 10 with the engine in neutral and up to operating temperature. Also make sure the "TPS" value is showing a value of 0. If it is not, you need to perform a TPS AUTOSET.

If the "IAC Position" value is showing zero, you must close the throttle plates until it reads a value of 2-10. Slowly turn the throttle shaft adjustment screw on the throttle body out (counter-clockwise). If the IAC position is "stuck" at 0, it is likely that the engine is idling at a higher speed than you have set the target idle speed for. You need to adjust the throttle plates to resolve this issue.

If the "IAC Position" value is greater than 10, it is a good idea to open (turn the throttle shaft adjustment screw in, clockwise) the throttle plates until the "IAC Position" value is between 2 and 10. Note that if you open the throttle plates such that the "TPS" position goes above a value of 0, you will need to shut the vehicle off and perform a TPS AUTOSET. Then restart the vehicle and continue adjusting the throttle plates. Once the TPS goes above a value of 0, the ECU goes out of its "idle" mode and will lock the IAC Position to a fixed value.

When the adjustments are completed, make sure the TPS reads a value of 0 with the engine idling.

25.0 SELF-TUNING

At this point, it is time to just drive the vehicle and let the system perform its self-tuning process. The best way for this is to drive the vehicle under as many different operating conditions as possible. Different engine speeds and loads. Start by slowly revving the engine up in neutral and holding it at different speeds up to 2500 RPM. This will help the system learn these points. Then drive the vehicle, possibly using different transmission gears to learn in different areas. If you have an automatic transmission you may want to put it in gear, and with your foot on the brake pedal, apply a SMALL amount of throttle so that the system learns in this area as well.

NOTE: There are several conditions where Learning will NOT occur. They are the following:

- If the engine is below 160° F
- When the engine sees quick accelerator pedal movement
- Certain times when the accelerator pedal is lifted and the vehicle is coasting
- If the learn is disabled by the user

If you are interested in seeing if Self Tuning is completed in a certain area, you can look at the following:

- Select MONITORS from the HOME SCREEN
- Select the LEARN icon
- The FUEL LEARN STATUS indicates if the learn feature is active. The FUEL LEARN PERCENT indicates what the learn value is.
- Look at the CLOSED LOOP COMPENSATION value. Once this value is close to zero, learning is complete in an area.

At this point you can drive and enjoy your TERMINATOR X™ EFI as it is. The full instruction and tuning manual can be found on the product pages and describes in detail how you can adjust various parameters to further optimize fuel economy and overall performance, if desired.

26.0 IGNITION WIRING DIAGRAMS

“Coil -” Engine Speed Input - Terminator X NOT Controlling Ignition Timing

Use this if:

- You are using a stock type mechanical advance distributor with a stock inductive ignition coil. Examples of this would be any older style points distributor, a 1974-1981 GM large cap HEI.
- Do NOT use this input if you are using an aftermarket Capacitive Discharge (CD) ignition system such as a MSD, Mallory, or others. The ECU will be damaged if you connect to a capacitive discharge type ignition coil.

NOTE: Using this input, the EFI will **NOT** control the ignition timing of the engine. The timing will be based on the distributor initial, mechanical, and vacuum advance, just like it did with a carburetor.

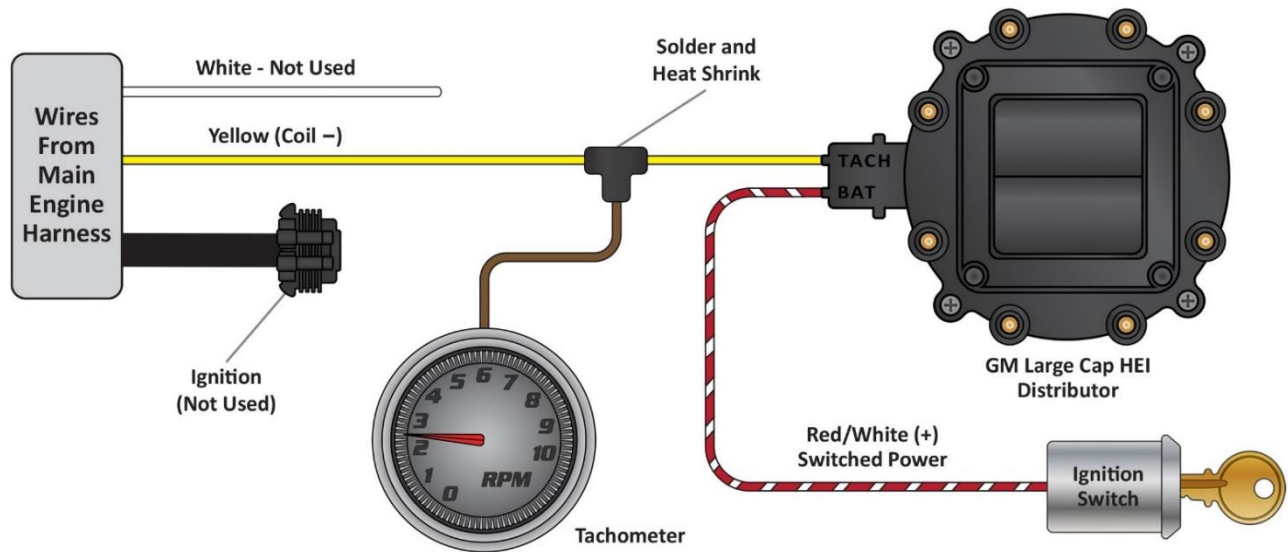

OR

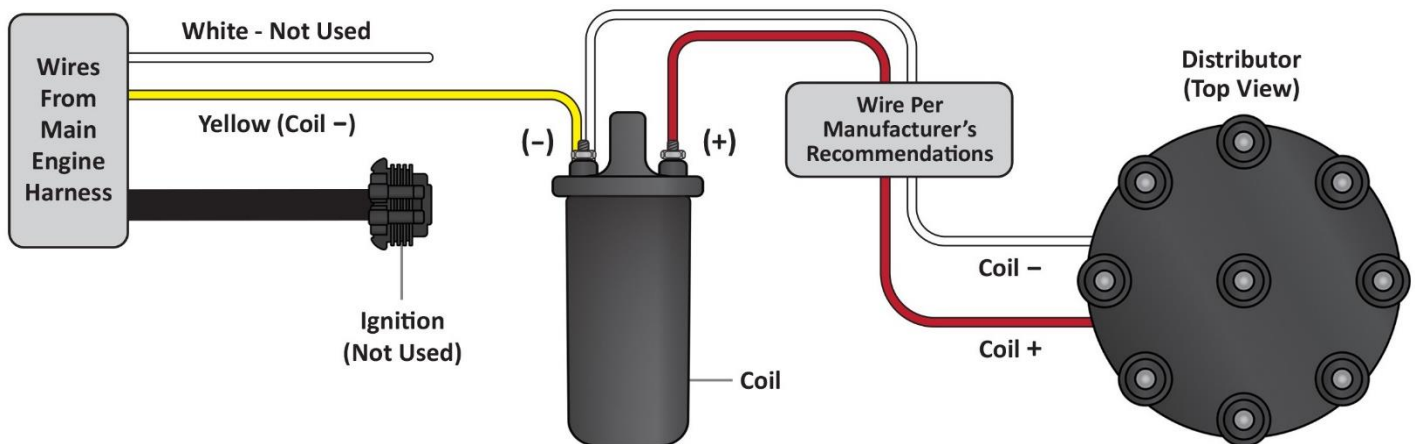

“CD Box (Tach Out)” Engine Speed Input- Terminator X NOT Controlling Ignition Timing

- If you are using an aftermarket Capacitive Discharge (CD) ignition system such as a MSD, Accel, or others, you need to connect to the “Tach Out” connection or wire these systems provide. This is a 12 volt square wave output.

CAUTION! NEVER, NEVER connect any of the EFI wires to the coil on any CD type ignition system. The ECU will be permanently damaged!

NOTE: Using this input, the EFI will **NOT** control the ignition timing of the engine. The timing will be based on the distributor initial, mechanical, and vacuum advance, just like it did with a carburetor.

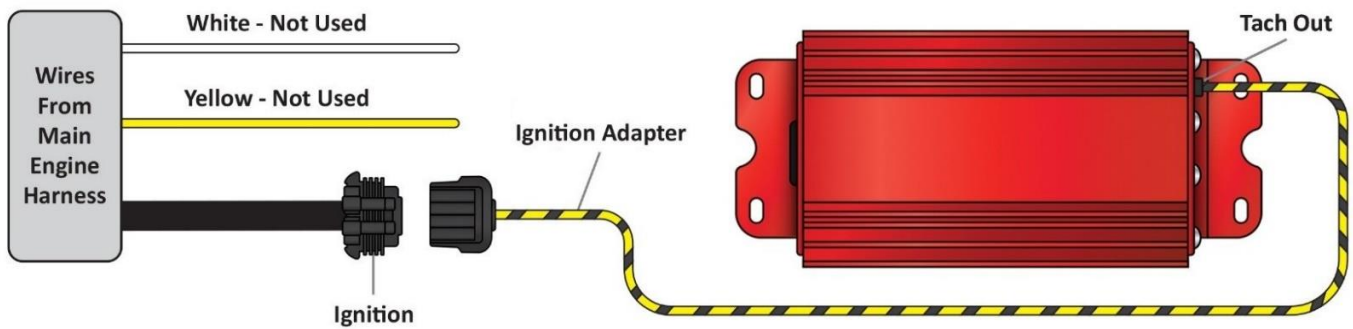

GM Small Cap HEI Computer Controlled Distributor – Terminator X Controlling Ignition Timing

(Requires Holley Ignition Adapter PN 558-304)

- Small and Big Block Chevy engines can use a small cap GM HEI computer controlled distributor that was available on factory GM vehicles from the 1980's through mid-1990's. This distributor is also available through MSD under part number 8366. The distributor (shown below) provides an engine speed signal to the EFI, as well as allowing the EFI to control the ignition timing.

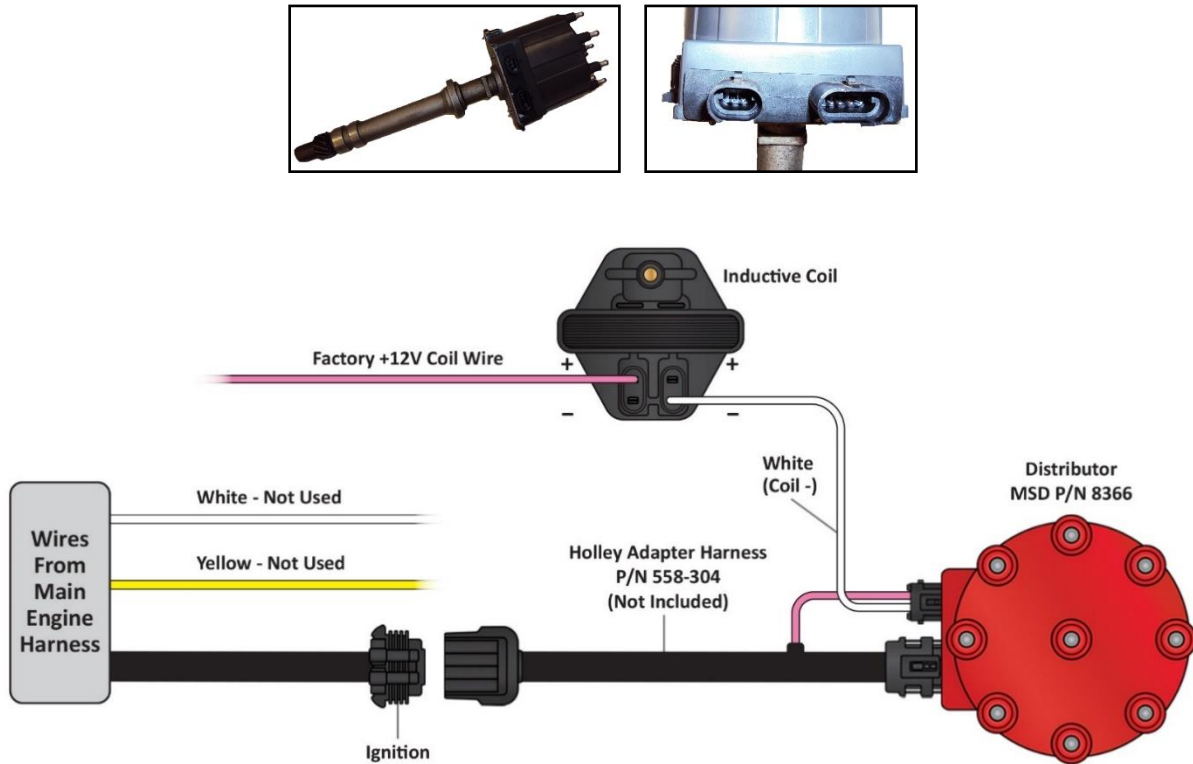

GM Small Cap HEI Computer Controlled Distributor w/ Capacitive Discharge Box – Terminator X Controlling Ignition Timing

(Requires Holley Ignition Adapter PN 558-304)

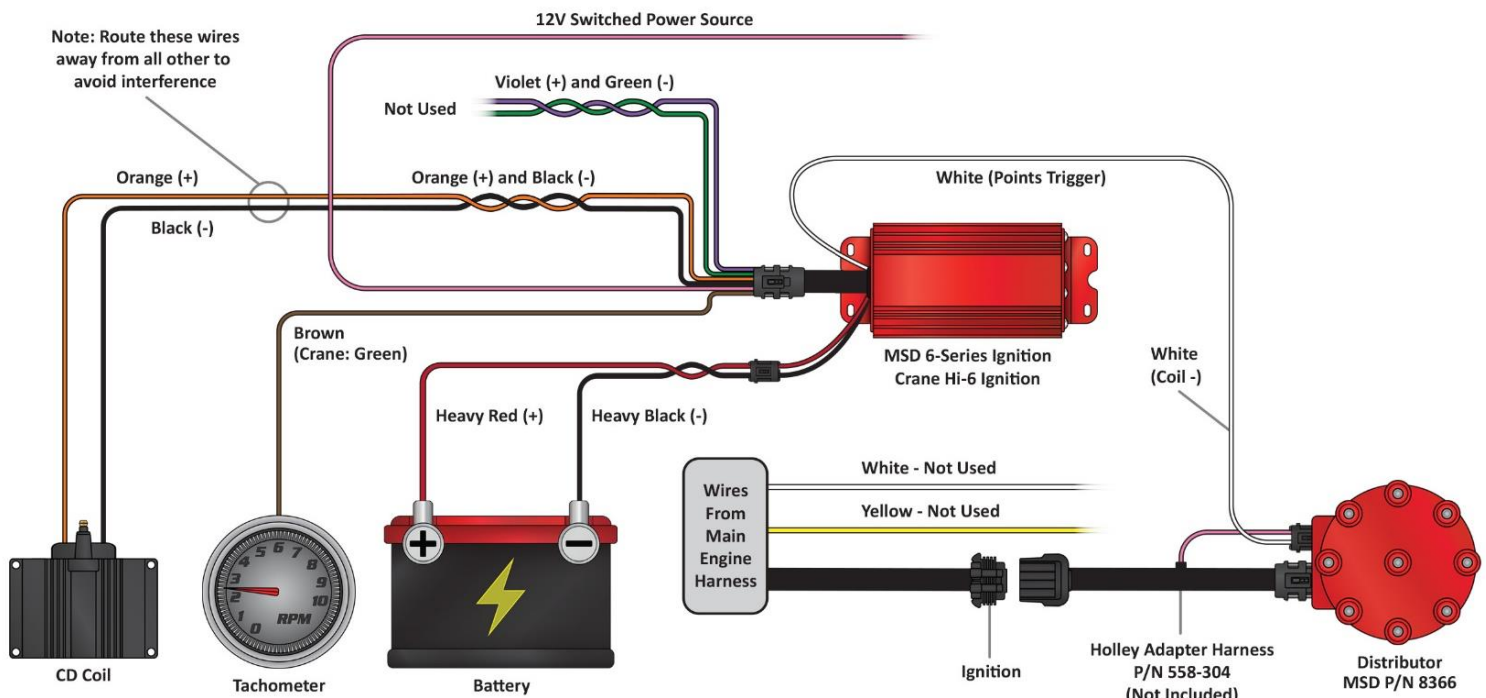

Ford TFI Computer Controlled Distributor – Terminator X Controlling Ignition Timing

(Requires Holley Ignition Adapter P/N 558-305)

- Ford Sequentially Injected 5.0-5.8L engines from 1987-1995 used this distributor. This option will allow the EFI to control the ignition timing.

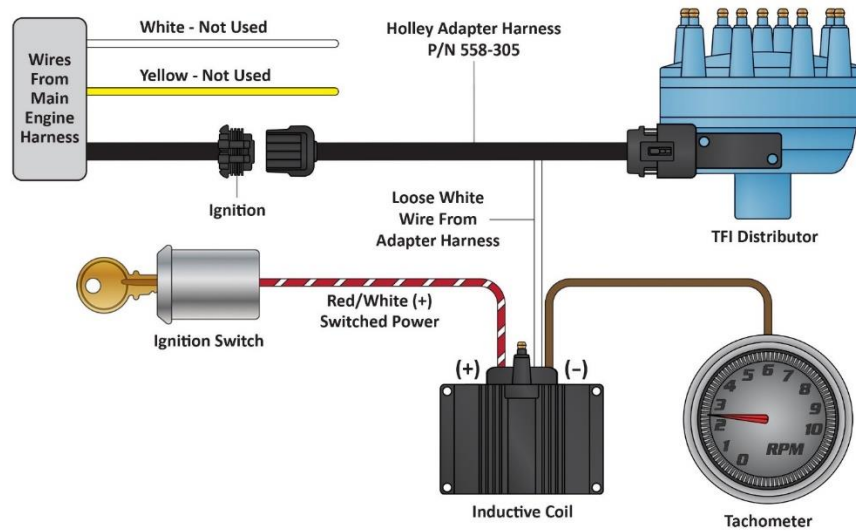

Ford TFI Computer Controlled Distributor w/ Capacitive Discharge Box – Terminator X Controlling Ignition Timing

(Requires Holley Ignition Adapter P/N 558-305)

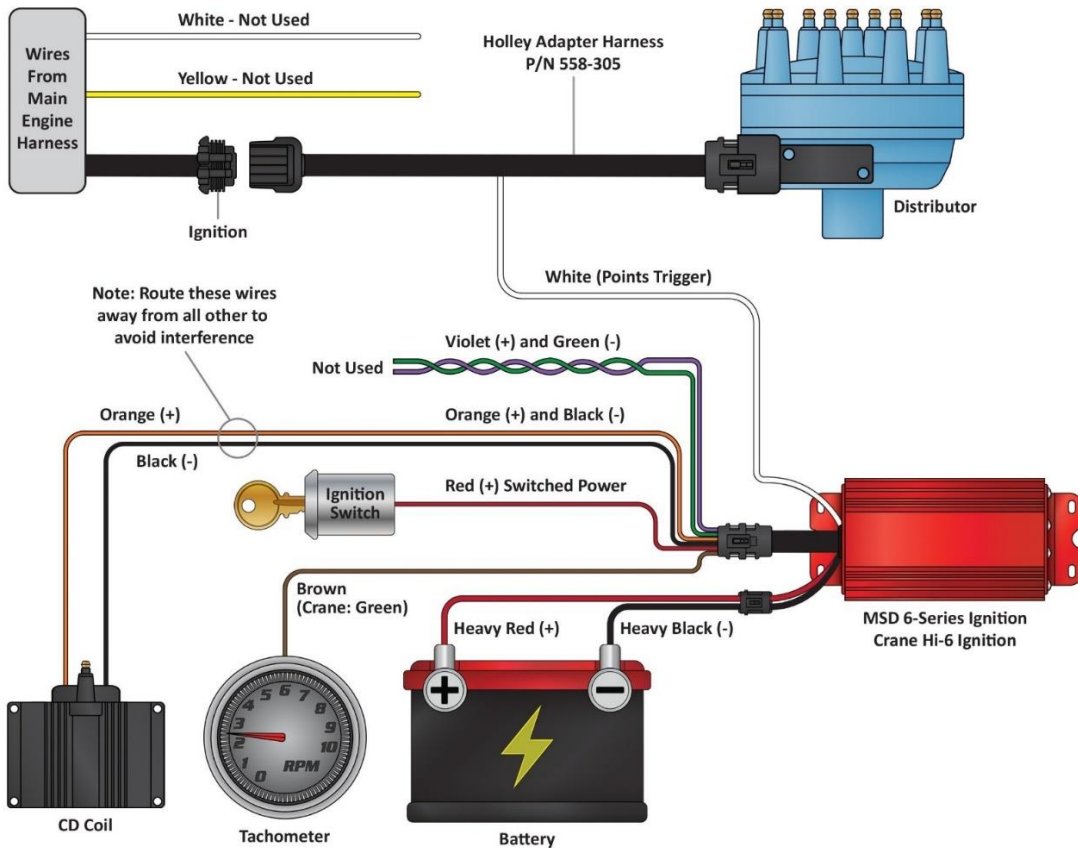

MSD Pro-Billet Distributor w/ Capacitive Discharge Box – Terminator X Controlling Ignition Timing

(Requires Holley Ignition Adapter P/N 558-324)

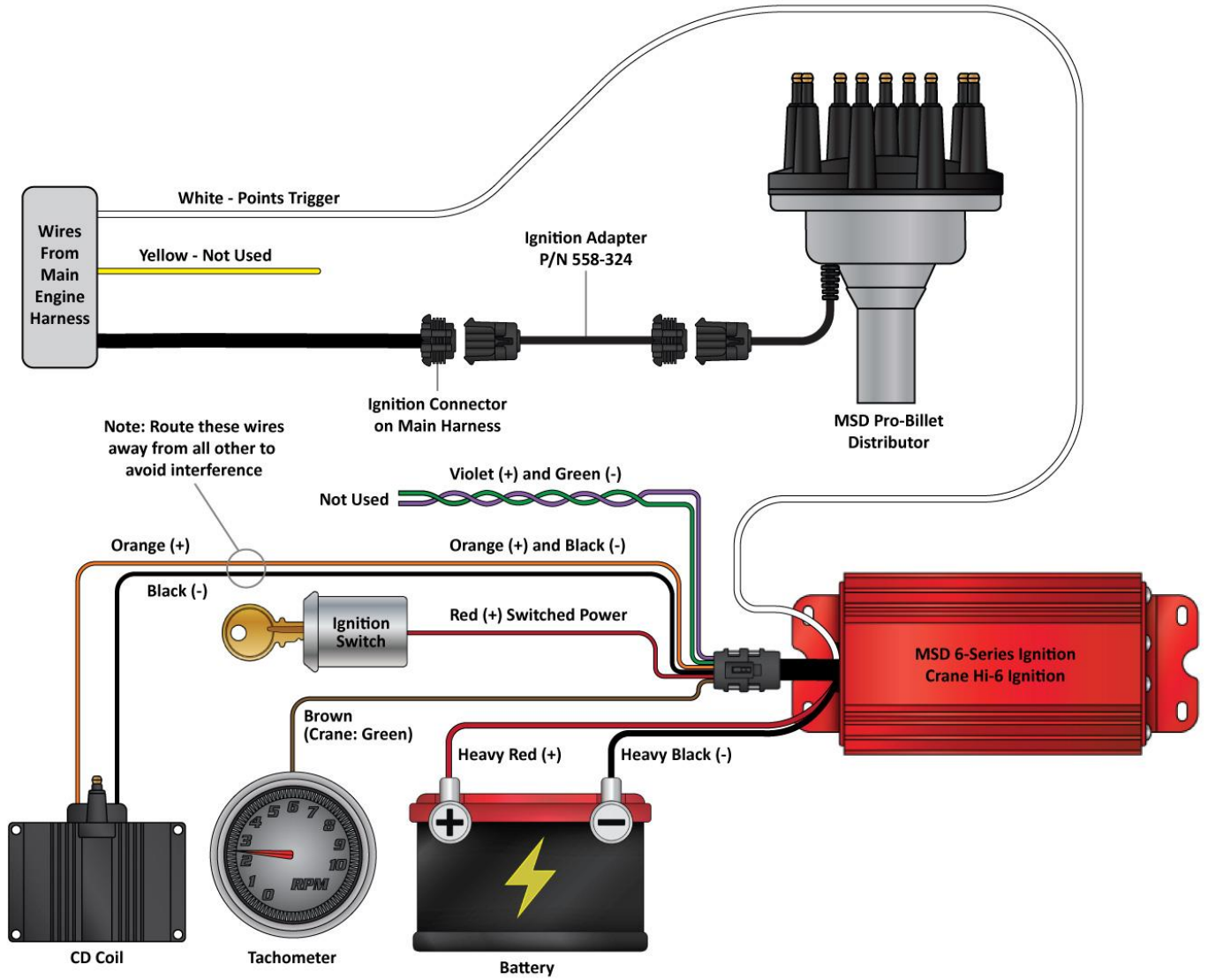

Holley EFI Dual Sync Distributor w/ Capacitive Discharge Box – Terminator X Controlling Ignition Timing

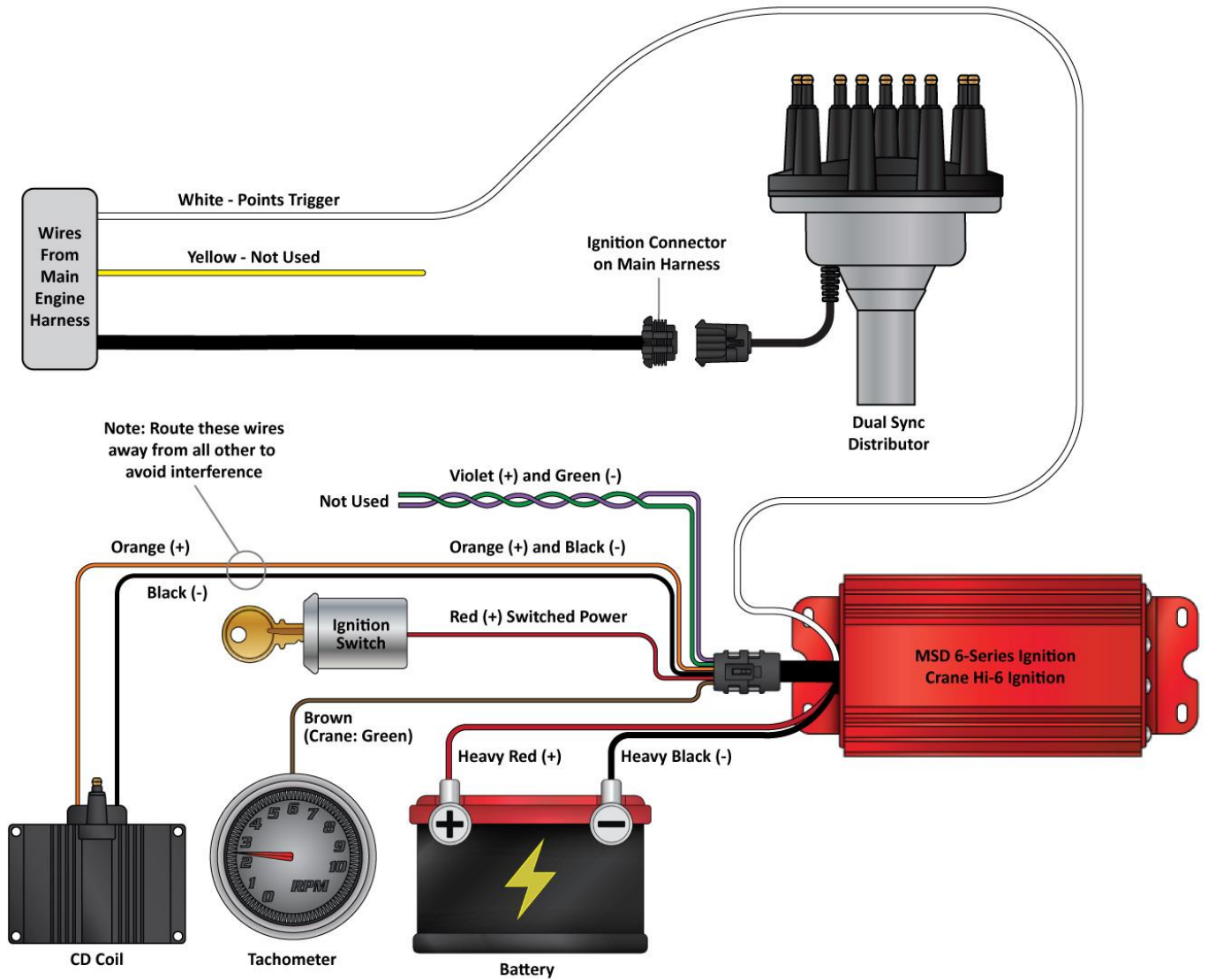

Holley Sniper EFI HyperSpark Distributor w/ Capacitive Discharge Box – Terminator X Controlling Ignition Timing

(Requires Holley Ignition Adapter P/N 558-323)

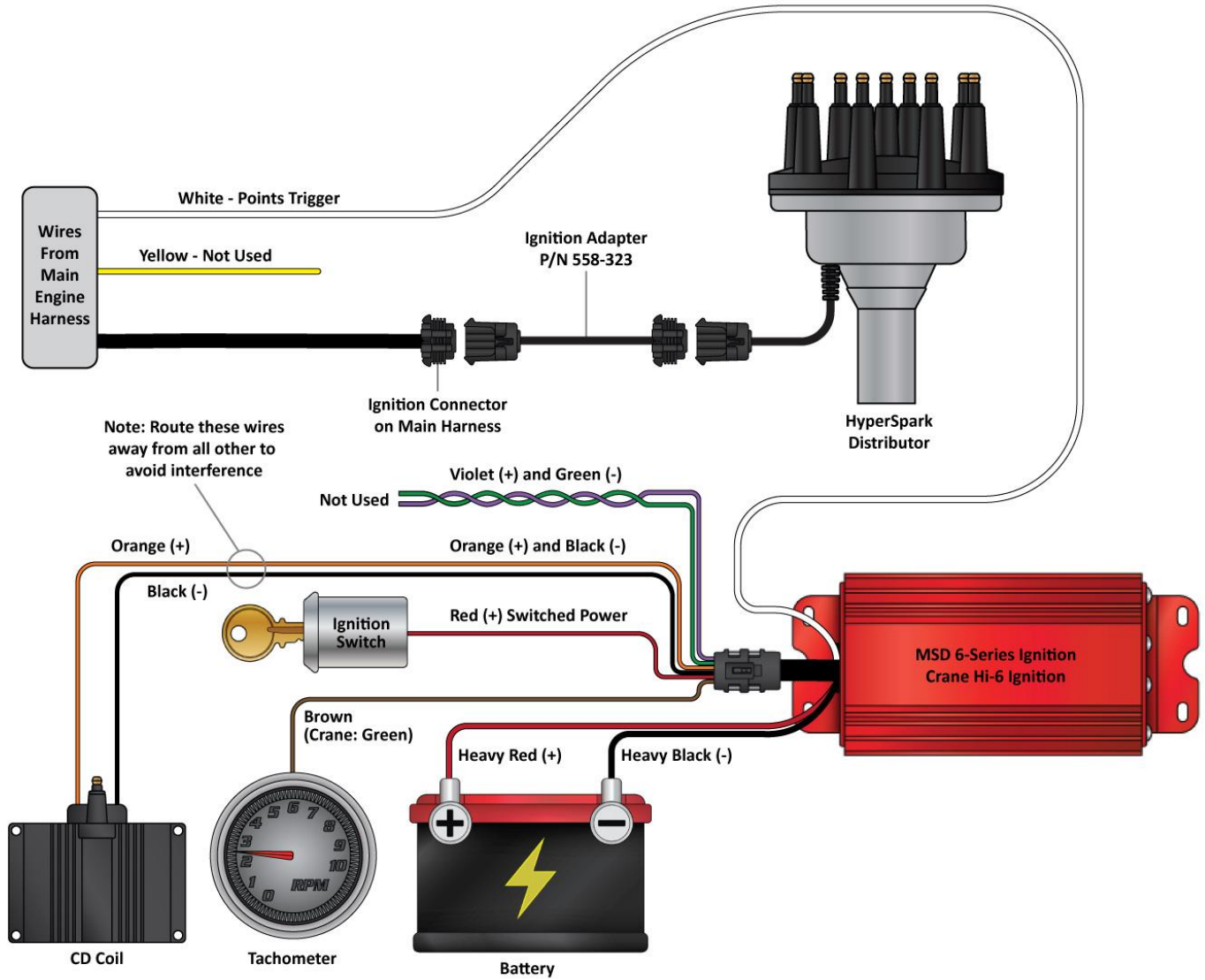

27.0 DIAGNOSTIC LED'S

LED#	Function	Color	Definition
1	Heartbeat	Green/Flash	ECU is powered
2	Engine running	Green	Engine is running
		Yellow	Engine is not running
3	Wideband status	Blue	too hot, too cold, slow warmup, uncalibrated
		Green	sensor is active and functioning properly
		Red	sensor is open or needs to be replaced
		Yellow	sensor is heating
		Off	sensor is disabled
4	TPS calibrated	Green	Calibrated
		Red	If DBW = Pedal & TB Calibration Error
			If non DBW - Calibration Error
		Cyan	DBW Pedal Calibration Error
		Purple	DBW TB Calibration Error
5	Off/undefined		Future
6	Crank	Green	When below Crank to Run RPM, tooth detected
		Blue	When below Crank to Run RPM, gap detected
		Red	Crank error detected -If engine continues to run, will stay Red until ECU is powered off -If engine shuts off due to severe signal loss, will stay Red until RPM re-sync OR key cycle
		Off	When above Crank to Run RPM and ECU is properly syncd
		Green	When below Crank to Run RPM, tooth detected
7	Cam	Blue	When below Crank to Run RPM, gap detected
		Red	Cam error detected -If engine continues to run, will stay Red until ECU is powered off -If engine shuts off due to severe signal loss, will stay Red until RPM re-sync OR key cycle
		Off	When above Crank to Run RPM and ECU is properly syncd
		Off/undefined	Future