

**Mounting instructions**

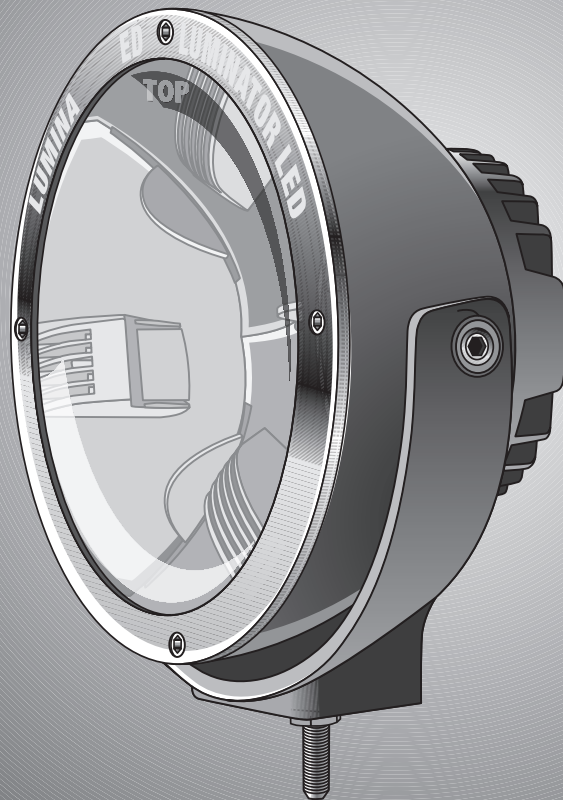

**Luminator LED**  
**Rallye 4000 LED**



## Tools required

 3 / 6 mm

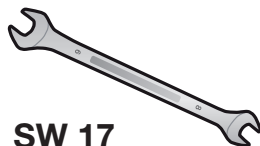

SW 17

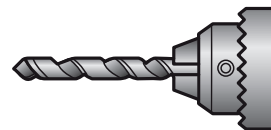

Ø 3,5 / 10,5 mm

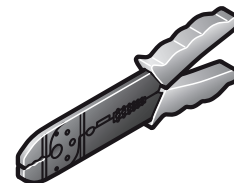
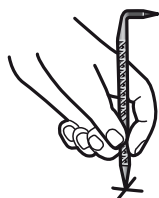
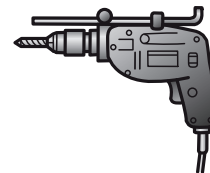
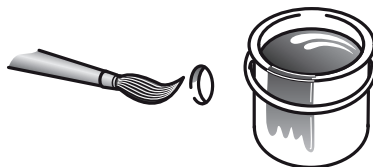
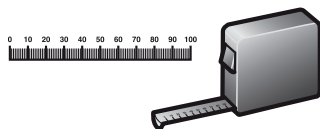

## **Kit includes**



## **Accessories**

(not included with kit)

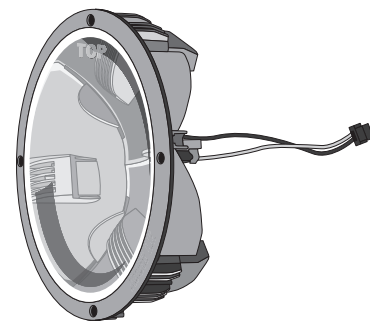

**1F8 181 541-011**



**8XS 147 945-011**

# Mounting

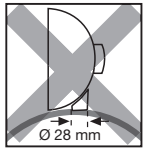
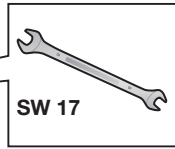
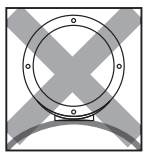
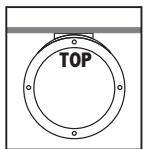
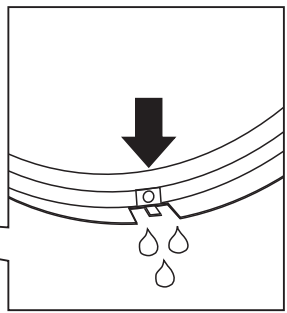
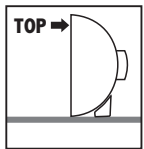
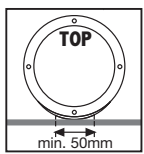
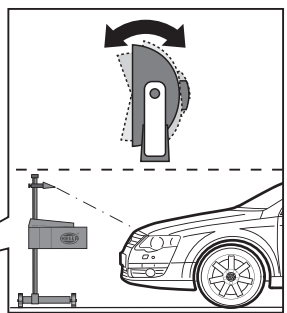
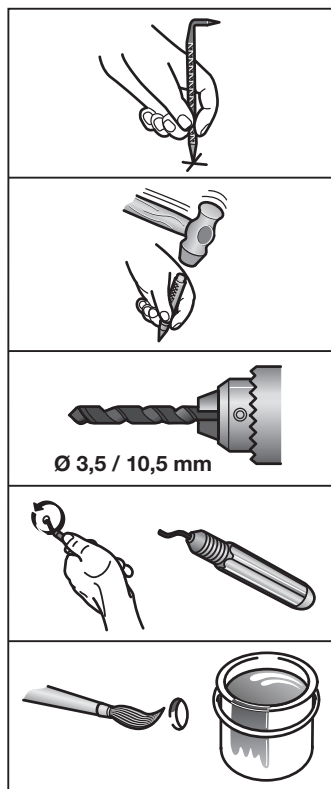

# Mounting

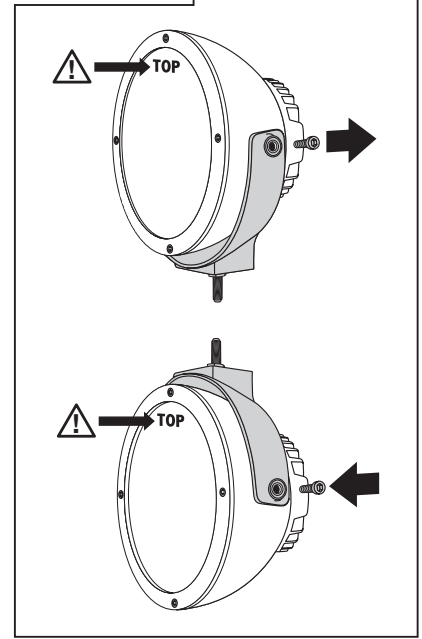
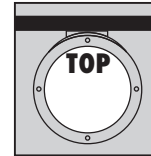
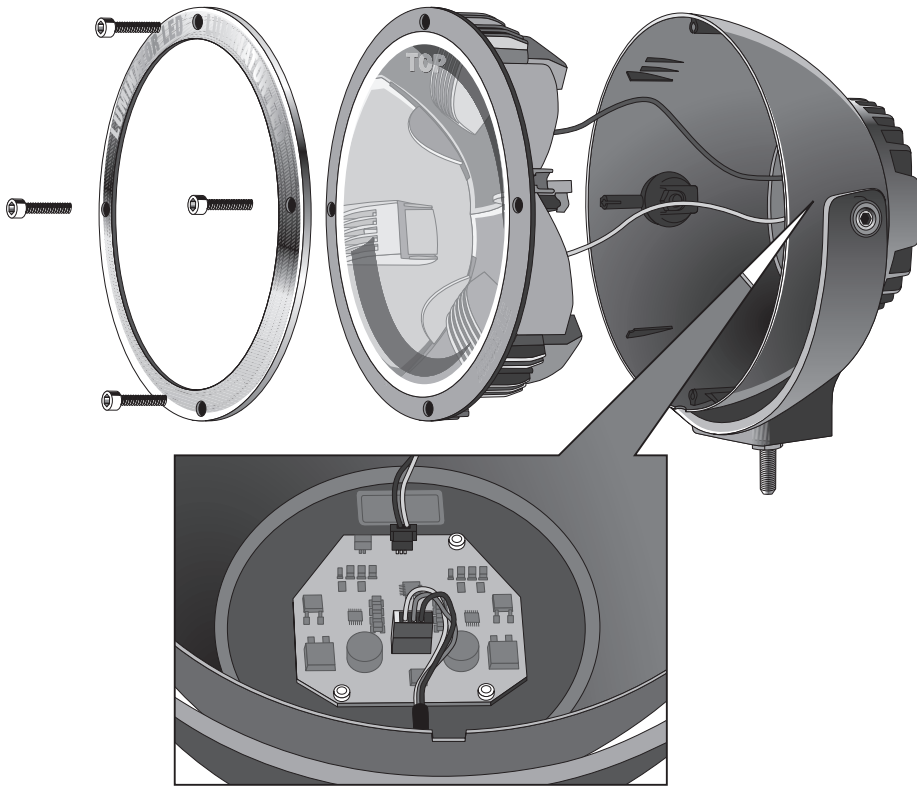

## Electrical connection

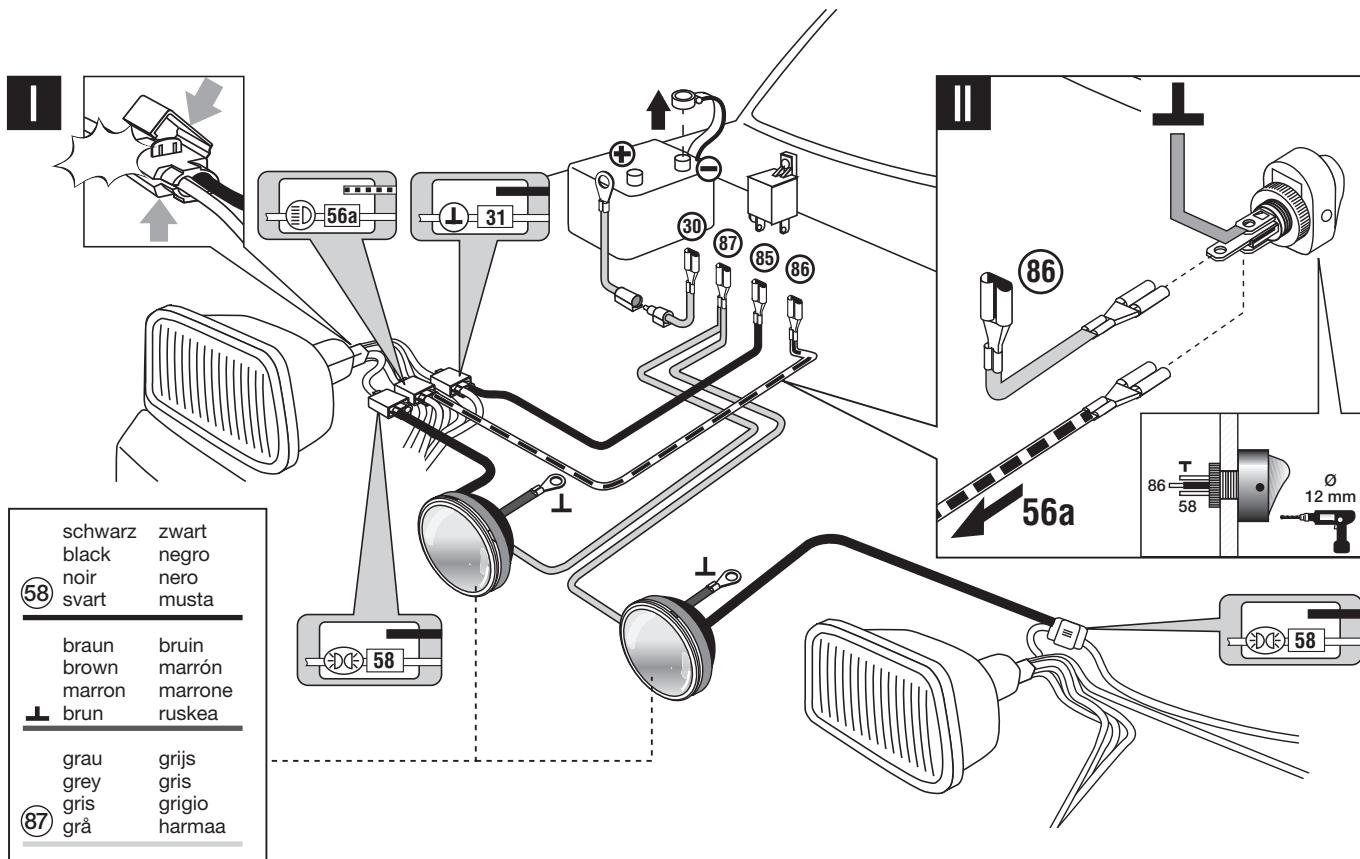

Subject to alteration without notice

## Installation dimensions

### Important:

Before mounting check whether the air supply to the radiator grille will still be sufficient (for cooling engine).

Mount both lamps above the bumper. Lamps may not vibrate or extend above the bonnet and must be attached symmetrically.

The use of an additional pair of parking lamps is not allowed in Great Britain. This means that the additional mounting instructions do not apply for Great Britain.

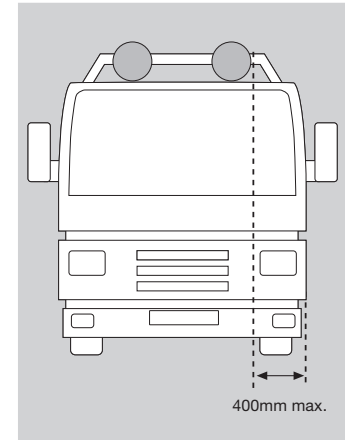
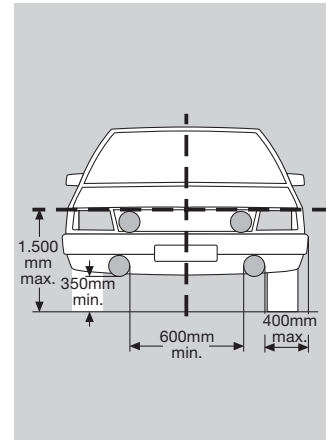

## Electrical connection: Fig. page 4

Use the Hella wiring harness developed especially for this purpose or connect the headlamps as follows:

Install the correct Hella relay (available as an accessory from stockists) with the connection terminals pointing downwards to protect it against splashwater.

24 V headlamps  
Relay part no.:  
**4RA 003 530-051**  
12 V headlamps  
Relay part no.:  
**4RA 003 530-001**

Lay and connect the cables in accordance with the circuit diagram. According to circuit diagram **I**, the auxiliary lights are switched on together with the existing spotlights. According to circuit diagram **II**, the auxiliary lights are switched on in addition

to the existing headlights via a separate switch.

**It is however essential that country-specific laws are observed.**

Check the lighting system, fasten the connection cables securely.

**Have the spotlights adjusted at a specialist garage.**

**Only correctly adjusted lights provide optimum light.**