

Havis Heavy Duty Passenger Side Mounts

General Installation Instructions

Required tools to complete installation.

- Large Metric Socket Set (1/2" drive)
- Small Metric and US Standard Socket Set (1/4" drive)
- 7/8" Wrench
- 1/2" Wrench
- 7/16" Wrench
- US Standard Allen Wrench Set
- Phillips head Screwdriver



Complete assembly in vehicle (2010 Ford Focus)

Required parts to complete assembly

Docking Station

(UT-X shown)

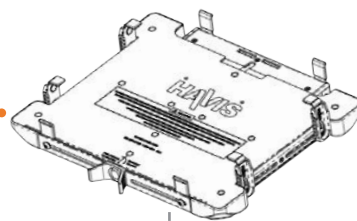

A

Motion Device

C-MD-202

Top Offset Platform

C-HDM-300 Series (C-HDM-303 shown)

Adaptor Plate

C-HDM-301 (included with Top Offset Platform)

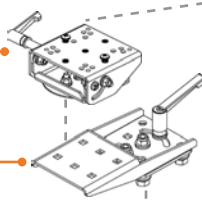

OR

B

Slide Out Locking Swing Arm with Motion Adapter

C-MD-112

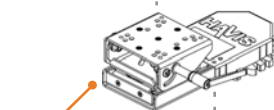

Pole Mount

C-HDM-200 Series (C-HDM-202 shown)

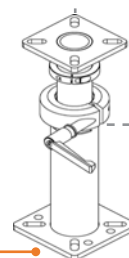

HDM Base & Offset Bracket

C-HDM-100 Series (C-HDM-118 shown)

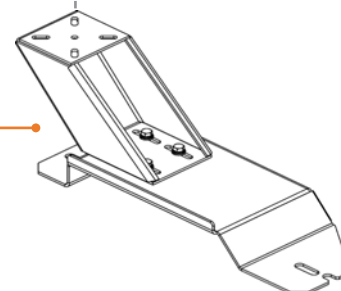

Optional parts for assembly



ChargeGuard®

CG-X



Power Supply

LPS-100/200 Series

Support Arm

C-HDM-401



For installation of Havis products, ALWAYS...

- Read all instructions before installing any Havis, Inc. Products.
- Check for obstructions (wire, brake lines, fuel tank, etc.)
- Use hardware provided with install kit

Havis Heavy Duty Passenger Side Mounts

General Installation Instructions

2010 Ford Focus used for instructions

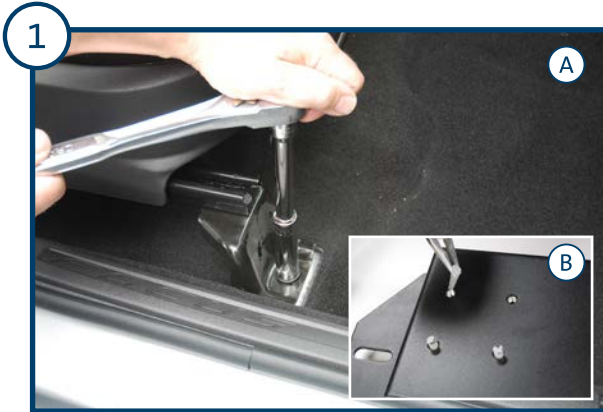

A) Remove the plastic caps that cover the seat bolts. Remove the OEM seat bolts, seat nuts and seat studs, making sure to keep the seat bolts for HDM Base installation (Step 3).
B) Remove all rubber thread protectors from the mounting holes on the HDM Base.



Lift the seat to place the HDM Base between the seat brackets and the floor.
NOTE: Loosening rear seat bolts may be required for ease of installation.



Align the HDM Base mounting holes to seat bolt locations and loosely attach the seat bolts. Use caution to avoid stripping the threads. Fully tighten the bolts once HDM Base is properly in place.

NOTE: Some HDM Bases mount under the vehicle seat bracket and reuse OEM seat bolts (A), while other HDM Bases mount over the top of vehicle seat bracket and use provided spacers and bolts (B).

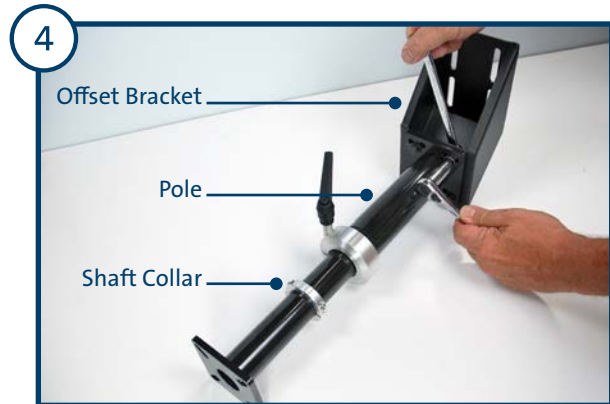

On the workbench, assemble the Offset Bracket and Pole using supplied 5/16" x 1" hex bolts, lock washers, and nuts (x4). Make sure all hardware is fully tightened. Attach the shaft collar anywhere on the inner pole, making sure to leave the shaft collar loose in order to adjust Pole height once installed in vehicle (Step 12).



Attach the assembled Offset Bracket and Pole to the HDM Base inside the vehicle, using supplied 5/16" x 3/4" hex bolts, lock washers, and flat washers. Make sure to adjust Offset Bracket to desired position before all hardware is fully tightened.

NOTE: If your application needs to be closer to center of vehicle, see optional C-HMD-409 Offset Plate.



A) Align the Adaptor Plate mounting studs to the top of the inner pole, then attach using the supplied 5/16" lock washers, flat washers, and nuts. Place the large plastic washer on top of Adaptor Plate.

B) Align Swing Arm with Motion Device mounting holes to the top of the inner pole, then attach using 1/4" lock washers, flat washers, and bolts.

NOTE: Make sure all hardware is fully tightened.

Havis Heavy Duty Passenger Side Mounts General Installation Instructions

2010 Ford Focus used for instructions

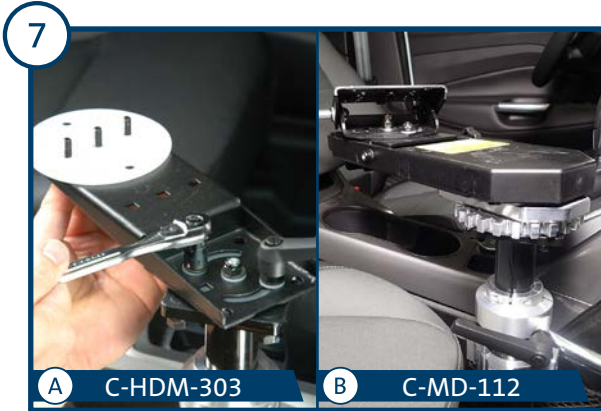

- A) Install the Top Offset with the supplied hardware and handle. Tighten the hardware to allow minimal motion. Place the large plastic washer on the Top Offset.
B) No adjustment required, please proceed to Step 8.

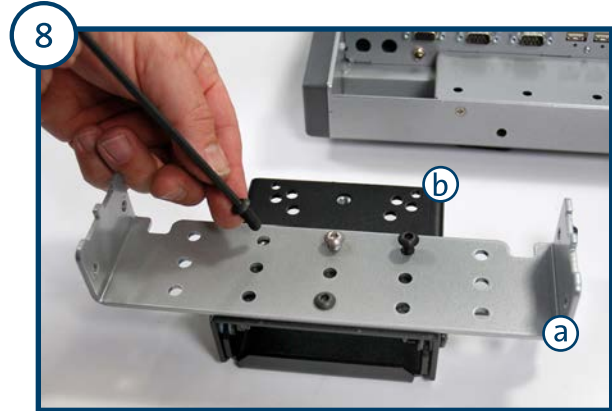

- Remove mounting bracket (a) from the bottom of the Docking Station and attach to the Motion Device (b).
NOTE: If attaching a Universal Laptop Mount (UT-X Series or C-3090 Series), mount directly to the Motion Device.

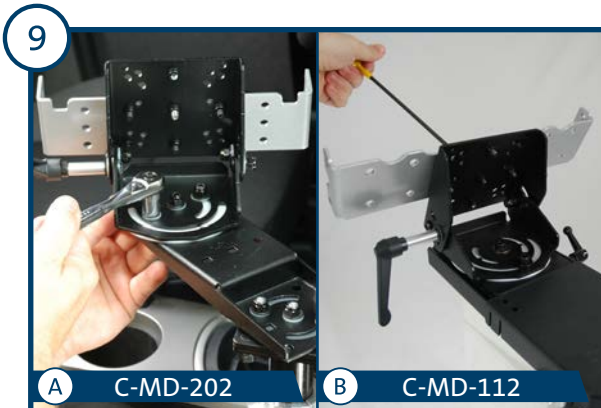

- A) Connect the Motion Device assembly to the Top Offset. Tighten the hardware to allow minimal motion.
NOTE: Motion Device has two (2) sets of holes.
3-bolt pattern allows for 90 rotation.
2-bolt pattern allows for 180 rotation.
B) Motion Device is already connected, please proceed to step 10.



- Attach the Power Supply to the designated mounting location on the Docking Station.



- Attach the Docking Station to the mounting bracket.

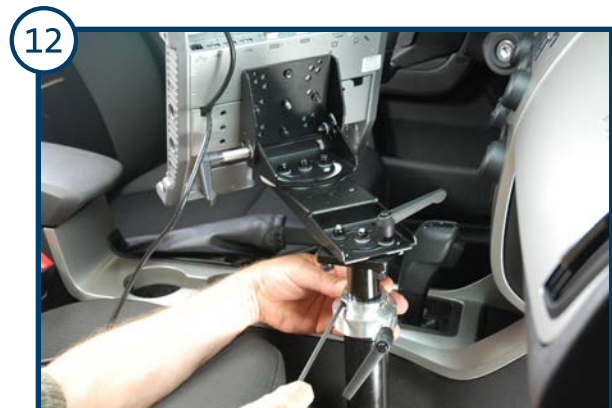

- Adjust the shaft collar to desired height and fully tighten.

Havis Heavy Duty Passenger Side Mounts General Installation Instructions

2010 Ford Focus used for instructions

13



To attach the optional two-piece support collar to the Pole, attach the side support arm to the two-piece support collar. Attach the side support arm to the underside of the dash with the supplied L bracket. Make sure all hardware is fully tightened.

14



If you are installing the optional ChargeGuard® Power Management System, run power wires to the ChargeGuard and connect to the fused, 12 volt battery. (Additional instructions inside the ChargeGuard box.)

15

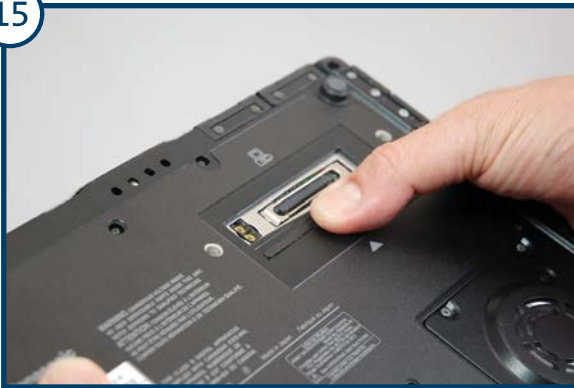

Congratulations, the installation is complete. To properly dock your computer into the Havis Docking Station, you must first open the docking connector door on the bottom of your computer or damages may occur.

16

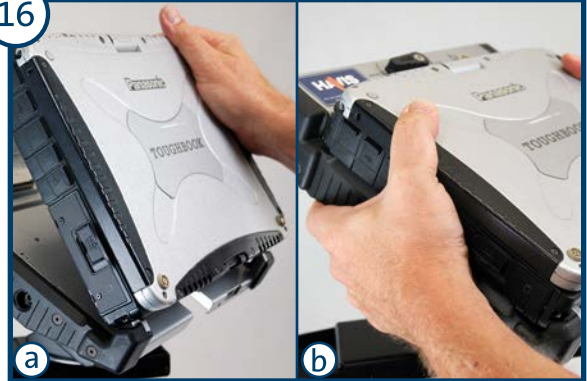

a) Load the front of the computer into the front hooks of the Docking Station.
b) Gently lower the back of the laptop down into the docking connector.

17

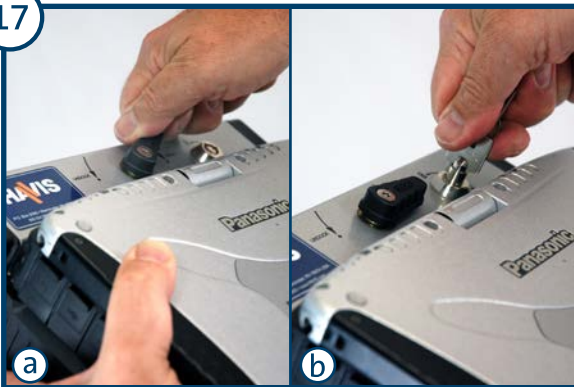

a) With the computer seated, turn the docking latch to the DOCK position.
b) Secure by locking the barrel lock with the supplied key.

18



You have successfully and safely docked your computer.

INSTALLATION INSTRUCTIONS

1. REMOVE RIGHT FRONT SEAT BOLT, AND LOOSEN LEFT FRONT SEAT BOLT.
2. SLIDE BASE PLATE IN BETWEEN FLOOR AND SEAT BRACKETS, FIRST ON THE LEFT SIDE FOLLOWED BY THE RIGHT.
3. REINSTALL THE RIGHT FRONT SEAT BOLT AND TIGHTEN THE LEFT FRONT SEAT BOLT, TIGHTENING BOTH TO VEHICLE MANUFACTURER'S TORQUE SPECIFICATION.
4. INSTALL THE SUPPORT BRACKET ONTO THE BOLT BELOW THE LEFT SIDE OF THE GLOVEBOX.
5. INSTALL THE TRIM ON THE LEADING EDGE OF THE BASE BRACKET AND TRIM AWAY EXCESS.
6. FOLLOW GENERAL INSTRUCTIONS FOR POLE AND UPPER MOUNT PARTS.

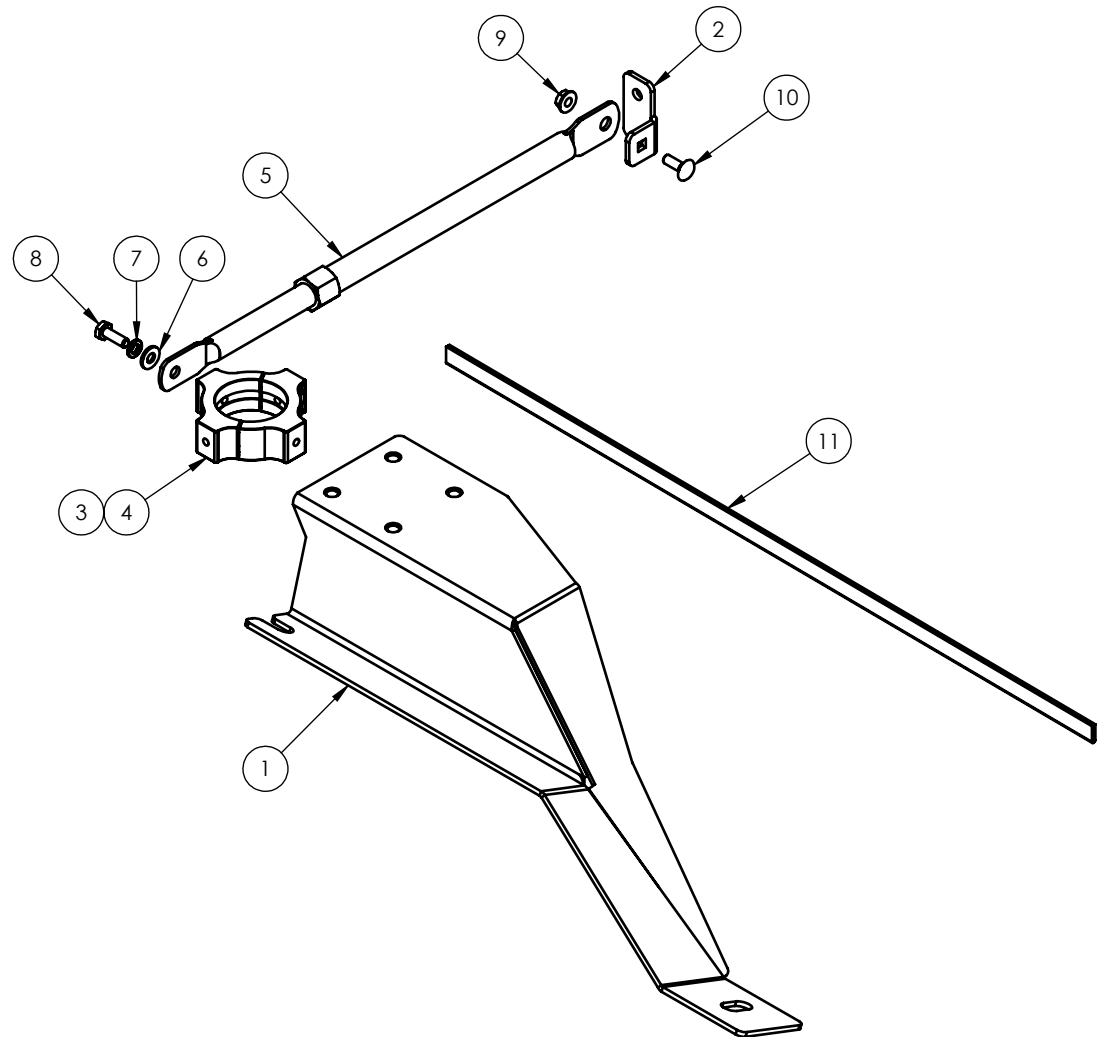

ITEM NO.	QTY.	DESCRIPTION	Revision
1	1	BRKT, HDM, NISSAN FRONTIER 2014-2017	A
2	1	BRKT, SUPPORT, NISSAN FRONTIER HDM	A
3	1	HK SPIDER COLLAR	A
4	2	EXTRUSION SPIDER, COLLAR HALF	B
5	1	ASSY SUPPORT ARM 12.5-19"	-
6	1	WASHER, 1/4 FLAT ZP, BLACK	
7	1	WASHER 1/4 LOCK ZP BLK	
8	1	SCREW 1/4-20 x 3/4" HHCS ZP BLK	
9	1	NUT 1/4-20 HEX FLANGE SERRATED ZP, BLK	
10	1	BOLT, 1/4-20 x 3/4 CARRIAGE ZP, BLK	
11	1	GIMP 1/8" BLACK 9/16" D (CUT TO 24.00")	
12	1	INST, NISSAN FRONTIER HDM BASE	1-17

HAVIS HAVIS, INC.

TITLE:
INSTALLATION INSTRUCTIONS, HDM
BASE, NISSAN FRONTIER

DO NOT SCALE DRAWING

SIZE A	DWG. NO. C-HDM-193-INST	REV 1-17
------------------	----------------------------	-------------

WEIGHT (LB): 5.94

SCALE: 1:5

SHEET 1 OF 1