

STAY CONNECTED.

VEHICLE. OFFICE. EVERYWHERE.

Havis partnered with Samsung to bring you a secure mobile solution for your vehicle.

Stay connected everywhere.



HAVIS

SAMSUNG



Samsung Desktop Experience Solution by Havis

Get true mobility with the Samsung DeX Experience. The Havis solution seamlessly connects your phone to the touch screen display and keyboard, allowing you to use your phone applications as if it were a desktop. Stay Connected. And, get your space back.

PRODUCT #	PRODUCT NAME
TSD-101	Havis Touch Screen Display
DS-DA-603	Havis USB-C Hub
C-DMM-3XXX	3000 Series Dash Mount
PKG-MAG-101	Magnetic Mount & Phone Cradle
PKG-KBM-106	USB Keyboard & Havis Mount



PANASONIC SOLUTIONS



HAVIS

Panasonic

HAVIS

PANASONIC AND HAVIS DOCKING STATIONS

TOUGHBOOK 33 DS-PAN-1200 SERIES



- Full port replication
- USB, RJ45, DB9, VGA, HDMI
- Lock & key provided

OPTIONS

- Basic or advanced port replication
- Dual pass-thru antenna
- Power supply

TOUGHBOOK 33 DS-PAN-1100 SERIES



- Full port replication
- USB, RJ45, DB9, VGA, HDMI
- Lock & key provided

OPTIONS

- Dual pass-thru antenna
- Power supply

TOUGHBOOK 20 DS-PAN-1000 SERIES



- Full port replication
- USB, RJ45, DB9, VGA, HDMI
- Lock & key provided

OPTIONS

- Dual pass-thru antenna
- Power supply

MG STATIONS

TOUGH PAD FZ-M1, FZ-B1 DS-PAN-900 SERIES



- Full port replication
- USB, RJ45, DB9, VGA, HDMI
- Lock & key provided

OPTIONS

- Basic or advanced port replication
- Dual pass-thru antenna
- Power supply

TOUGH PAD FZ-G1 DS-PAN-700 SERIES



- Full port replication
- USB, RJ45, DB9, VGA, HDMI
- Lock & key provided

OPTIONS

- Dual pass-thru antenna
- Power supply

TOUGHBOOK FZ-L1 DS-PAN-1300 SERIES



- Easy 1 hand operation
- USB Port Replication
- Lock & key provided

OPTIONS

- Dual pass-thru antenna
- Power supply

TOUGHBOOK 54 DS-PAN-420 SERIES



- Full port replication
- USB, RJ45, DB9, VGA, HDMI
- Lock & key provided

OPTIONS

- Dual pass-thru antenna
- Power supply

PANASONIC SOLUTIONS

Industry Leading Solutions. Havis Rugged Quality.

PREMIUM SOLUTION

C-DMM-3000 series, C-VS series, C-MD-119; PKG-KBM-106

- Vehicle specific console
- Flip-up DMM tablet mount
- Keyboard mount with slide and tilt
- Quick release keyboard tray
- Easy access to controls



SOLUTIONS



CONSOLE & TABLET

C-DMM-3000; PKG-KBM-106

- Flip-up Dash Mount, holds 12 lbs
- Passenger access
- Havis USB keyboard & mount



CONSOLE & LAPTOP

C-HDM-204, C-MD-119

- Heavy duty telescoping side mount
- 11" slide out arm & low profile rotation
- 180° horizontal rotation



CONSOLE & TOUCH SCREEN

C-DMM-2000, TSD-101; PKG-KBM-106

- Flip-up Dash Mount, holds 4 lbs
- Passenger view
- Havis USB keyboard & mount

DASH MOUNT SOLUTIONS

PREMIUM DASH MOUNT

C-DMM-3000 series; PKG-KBM-106

- Flip-up dash mount
- 12 lb carrying weight
- Secure dual action latch
- Access to vehicle controls
- Driver & passenger access
- No drill solution
- 30 minute install
- Havis keyboard & mount



TOUCH SCREEN DASH MOUNT

C-DMM-2000 series; TSD-101; PKG-KBM-106

- Flip-up dash mount
- 4 lb carrying weight
- Landscape or portrait viewing
- Access to vehicle controls
- Driver & passenger access
- Havis keyboard & mount



PEDESTAL MOUNT SOLUTIONS

PREMIUM SOLUTION

PKG-PSM-3000 series

- Heavy duty base, pole, & side support
- Mounts to existing OEM seat bolt
- Swing arm & motion device

STANDARD SOLUTION

PKG-PSM-1000 series

- Heavy duty base, pole, tilt swivel & offset
- Mounts to existing OEM seat bolt

FLEXIBLE SOLUTION

PKG-FAM-100 series

- Flex Arm and seat mount
- Swivel ball on top holds 5lbs
- Quick release for easy discharge







REMOTE MOUNTING SOLUTION

TRUNK MOUNTING SOLUTION

C-TTP-INUT series; C-SBX series; TSD-101

- Utilizes cabin space
- Complete screen mirroring
- Space saving solution

MATERIAL HANDLING



MATERIAL HANDLING SOLUTIONS

- Universal pallet jack mounting C-MH-2001
- Overhead forklift mount: C-MH-1009
- Work station drill mount: MH-1010
- Clamp mount: MH-1011
- Bar clamp mount: C-MD-403

COMPLETE SOLUTIONS

Dash Monitor Mounts
Consoles
Pedestal Mounts
Handhelds

Docking Stations
Keyboards
Connectivity
Power

Prisoner Transport
K9
Storage

ABOUT HAVIS

Havis is the Leader in Rugged & Innovative Mobility Solutions.

Proudly supporting public safety for more than 80 years.

Havis products are now available to multiple markets & industries.

Partners include Global Leaders:

Ford, Chevy, Dodge, Dell, Panasonic & Getac.

The logo for HAVIS, featuring the word "HAVIS" in a bold, white, sans-serif font. The letter "V" is stylized with a diagonal slash through it.

DELL SOLUTIONS

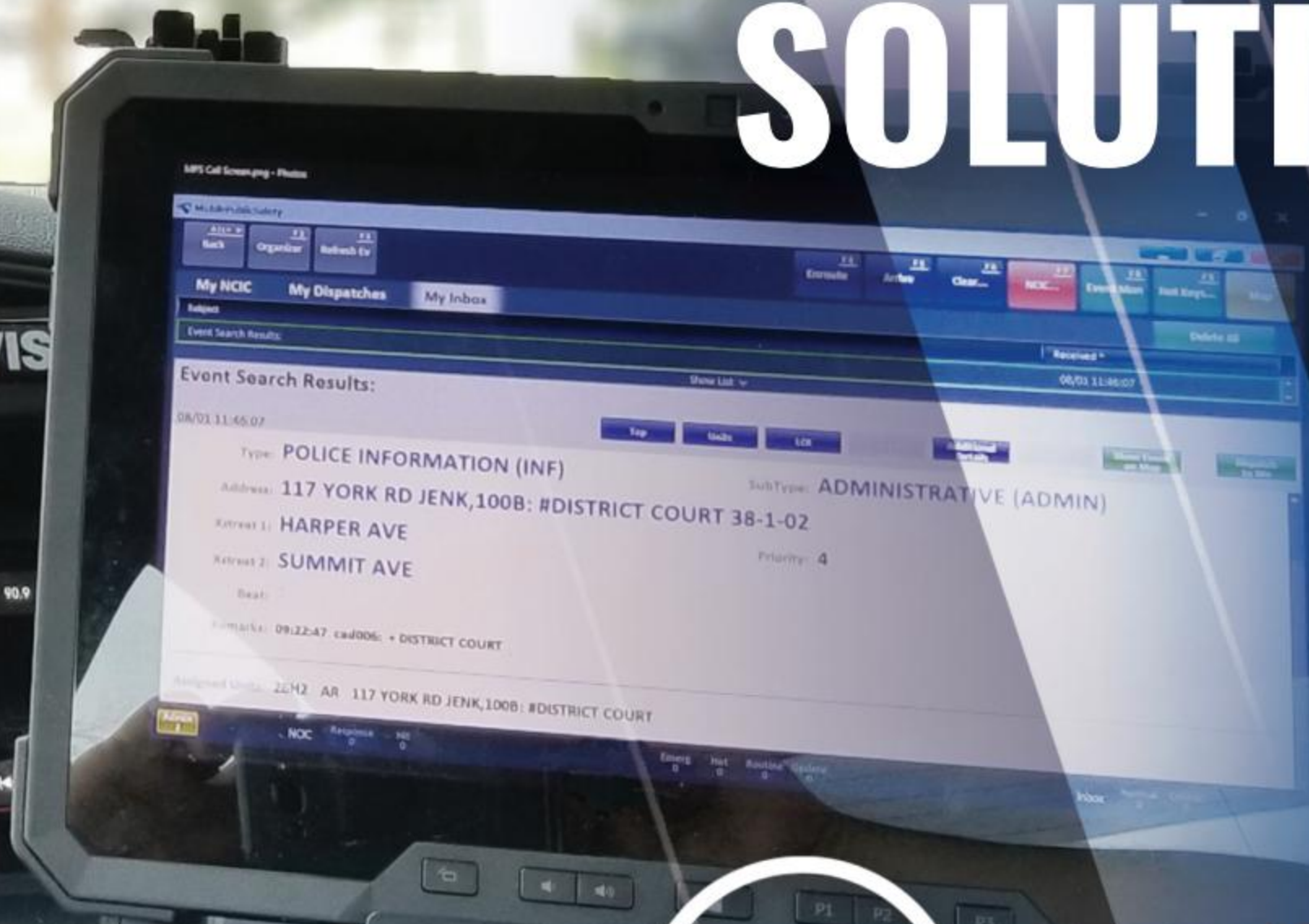

HAVIS

90.9 90.9 90.9

AM

FM

Browse



WARN
Monitor Mount
closed when y
in milio



HAVIS

DELL AND HAVIS DOCKING STATIONS

LATITUDE 12 & 14 LAPTOP DS-DELL-410 SERIES



- Adjustable locking arms
- USB, RJ45, DB9, VGA, HDMI
- Speaker & mic I/O
- Lock & key provided

OPTIONS

- Basic or advanced port replication
- Triple pass-thru antenna
- Power supply: internal/external

LATITUDE 12 TABLET DS-DELL-600 SERIES



- Full port replication
- USB, RJ45, DB9, VGA, HDMI
- Speaker & mic I/O
- Lock & key provided

OPTIONS

- Dual pass-thru antenna
- Power supply: internal/external

LATITUDE 12 TABLET DS-DELL-610 SERIES



- Full port replication
- USB, RJ45, DB9, VGA, HDMI
- Speaker & mic I/O
- Lock & key provided

OPTIONS

- Dual pass-thru antenna
- Power supply: external

LATITUDE 12 TABLET DS-DELL-700 SERIES



- Full port replication
- On-board power
- Permanent mounting
- USB, RJ45, DB9

OPTIONS

- IP65 Rated
- Powered DB9



DELL SOLUTIONS

Industry Leading Solutions. Havis Rugged Quality.

PREMIUM SOLUTION

C-DMM-3000 series, C-VS series, C-MD-119; PKG-KBM-106

- Vehicle specific console
- Flip-up DMM tablet mount
- Keyboard mount with slide and tilt
- Quick release keyboard tray
- Easy access to controls



SOLUTIONS



CONSOLE & TABLET

C-DMM-3000; PKG-KBM-106

- Flip-up dash mount, holds 12 lbs
- Passenger access
- Havis USB keyboard & mount



CONSOLE & LAPTOP

C-HDM-204; C-MD-119

- Heavy duty telescoping side mount
- 11" slide out arm & low profile rotation
- 180° horizontal rotation



CONSOLE & TOUCH SCREEN

C-DMM-2000; TSD-101; PKG-KBM-106

- Flip-up dash mount, holds 4 lbs
- Passenger view
- Havis USB keyboard & mount

DASH MOUNT SOLUTIONS

PREMIUM DASH MOUNT

C-DMM-3000 series; PKG-KBM-106

- Flip-up dash mount
- 12 lb carrying weight
- Secure dual action latch
- Access to vehicle controls
- Driver & passenger access
- No drill solution
- 30 minute install
- Havis keyboard & mount





TOUCH SCREEN DASH MOUNT

C-DMM-2000 series; TSD-101; PKG-KBM-106

- Flip-up dash mount
- 4 lb carrying weight
- Landscape or portrait viewing
- Access to vehicle controls
- Driver & passenger access
- Havis keyboard & mount

PEDESTAL MOUNT SOLUTIONS

PREMIUM SOLUTION

PKG-PSM-3000 series

- Heavy duty base, pole, & side support
- Mounts to existing OEM seat bolt
- Swing arm & motion device

STANDARD SOLUTION

PKG-PSM-1000 series

- Heavy duty base, pole, tilt swivel & offset
- Mounts to existing OEM seat bolt

FLEXIBLE SOLUTION

PKG-FAM-100 series

- Flex Arm and seat mount
- Swivel ball on top holds 5lbs
- Quick release for easy discharge







REMOTE MOUNTING SOLUTION

TRUNK MOUNTING SOLUTION

C-TTP-INUT series; C-SBX series; TSD-101

- Utilizes cabin space
- Complete screen mirroring
- Space saving solution

MATERIAL HANDLING



MATERIAL HANDLING SOLUTIONS

- Universal pallet jack mounting C-MH-2001
- Overhead forklift mount: C-MH-1009
- Work station drill mount: MH-1010
- Clamp mount: MH-1011
- Bar clamp mount: C-MD-403

COMPLETE SOLUTIONS

Dash Monitor Mounts
Consoles
Pedestal Mounts
Handhelds

Docking Stations
Keyboards
Connectivity
Power

Prisoner Transport
K9
Storage

ABOUT HAVIS

Havis is the Leader in Rugged & Innovative Mobility Solutions.

Proudly supporting public safety for more than 80 years.

Havis products are now available to multiple markets & industries.

Partners include Global Leaders:

Ford, Chevy, Dodge, Dell, Panasonic & Getac.

The logo for HAVIS, featuring the word "HAVIS" in a bold, white, sans-serif font. The letter "V" is stylized with a diagonal slash through it.

GETAC SOLUTIONS

Getac **HAVIS**



GETAC AND HAVIS DOCKING STATIONS

K120 TABLET DS-GTC-900 Series



- Full port replication
- Easy 1 hand operation
- USB, RJ45, HDMI, VGA, DB9
- Lock & key provided

OPTIONS

- Getac power supply
- Triple pass-thru antenna

K120 LAPTOP DS-GTC-1000 Series



- Full port replication
- Easy 1 hand operation
- USB, RJ45, HDMI, VGA DB9
- Lock & key provided

OPTIONS

- Getac power supply
- Triple pass-thru antenna
- Screen support

S410 DS-GTC-610 Series



- Full port replication
- USB, RJ45, HDMI, VGA, DB9
- Speaker & mic I/O
- Lock & key provided

OPTIONS

- Getac power supply
- Triple pass-thru antenna
- Screen support

UX10 DS-GTC-1100 Series



- Full port replication
- Easy 1 hand operation
- USB, RJ45, DB9
- Lock & key provided

OPTIONS

- Getac power supply
- Triple pass-thru antenna

MG STATIONS

T800

DS-GTC-410 Series



- Full port replication
- Easy 1 hand operation
- USB, RJ45, DB9
- Lock & key provided

OPTIONS

- Lind power supply
- Triple pass-thru antenna

V110

DS-GTC-310 Series



- Full port replication
- USB, Rj45, DB9, VGA, HDMI
- Speaker & mic I/O
- Lock & key provided

OPTIONS

- Lind power supply
- Triple pass-thru antenna
- Screen support

A140

DS-GTC-800 Series



- Full port replication
- USB, RJ45, DB9, HDMI, VGA
- Speaker & mic I/O
- Lock & key provided

OPTIONS

- Getac power supply
- Triple pass thru antenna

F110

DS-GTC-210 Series



- Full port replication
- USB, RJ45, DB9, VGA, HDMI
- Speaker & mic I/O
- Lock & key provided

OPTIONS

- Lind power supply
- Triple pass-thru antenna

GETAC SOLUTIONS

Industry Leading Solutions. Havis Rugged Quality.

PREMIUM SOLUTION

C-DMM-3000 series, C-VS series, C-MD-119; PKG-KBM-106

- Vehicle specific console
- Flip-up DMM tablet mount
- Keyboard mount with slide and tilt
- Quick release keyboard tray
- Easy access to controls



SOLUTIONS



CONSOLE & TABLET

PKG-KBM-106; C-DMM-3000

- Flip-up Dash Mount, holds 12 lbs
- Passenger access
- Havis USB keyboard & mount



CONSOLE & LAPTOP

C-HDM-204; C-MD-119

- Heavy duty telescoping side mount
- 11" slide out arm & low profile rotation
- 180° horizontal rotation



CONSOLE & TOUCH SCREEN

TSD-101; C-DMM-2000; PKG-KBM-106

- Flip-up Dash Mount, holds 4 lbs
- Passenger view
- Havis USB keyboard & mount

DASH MOUNT SOLUTIONS

PREMIUM DASH MOUNT

C-DMM-3000 series; PKG-KBM-106

- Flip-up dash mount
- 12 lb carrying weight
- Secure dual action latch
- Access to vehicle controls
- Driver & passenger access
- No drill solution
- 30 minute install
- Havis keyboard & mount

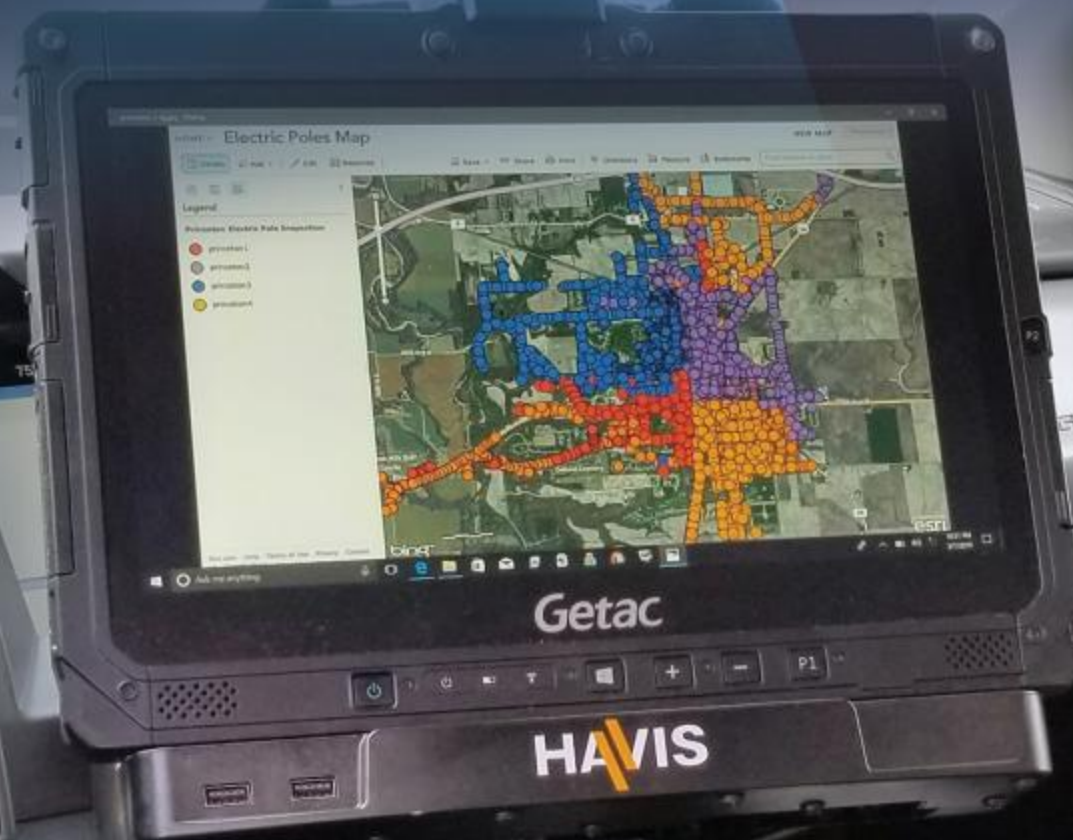



TOUCH SCREEN DASH MOUNT

C-DMM-2000 series; TSD-101; PKG-KBM-106

- Flip-up dash mount
- 4 lb carrying weight
- Landscape or portrait viewing
- Access to vehicle controls
- Driver & passenger access
- Havis keyboard & mount

PEDESTAL MOUNT SOLUTIONS

PREMIUM SOLUTION

PKG-PSM-3000 series

- Heavy duty base, pole, & side support
- Mounts to existing OEM seat bolt
- Swing arm & motion device

STANDARD SOLUTION

PKG-PSM-1000 series

- Heavy duty base, pole, tilt swivel & offset
- Mounts to existing OEM seat bolt

FLEXIBLE SOLUTION

PKG-FAM-100 series

- Flex Arm and seat mount
- Swivel ball on top holds 5lbs
- Quick release for easy discharge







REMOTE MOUNTING SOLUTION

TRUNK MOUNTING SOLUTION

C-TTP-INUT Series; C-SBX series; TSD-101

- Utilizes cabin space
- Complete screen mirroring
- Space saving solution

MATERIAL HANDLING



MATERIAL HANDLING SOLUTIONS

- Universal pallet jack mounting C-MH-2001
- Overhead forklift mount: C-MH-1009
- Work station drill mount: MH-1010
- Clamp mount: MH-1011
- Bar clamp mount: C-MD-403

FORD INTERCEPTOR UTILITY SOLUTIONS

2020



HAVIS



SOLUTIONS FOR FORD INTERCEPTOR UTILITY

Market Leading Solutions for Public Safety Vehicles.

CONSOLE PREMIUM

C-ARM-108; CUP2-1001; C-AP-0325; CG-X

- Vehicle Specific Console
- Side mount arm rest
- Dual cup holder, mic clip & brackets
- Accessory pockets & LED map light
- Chargeguard power monitor

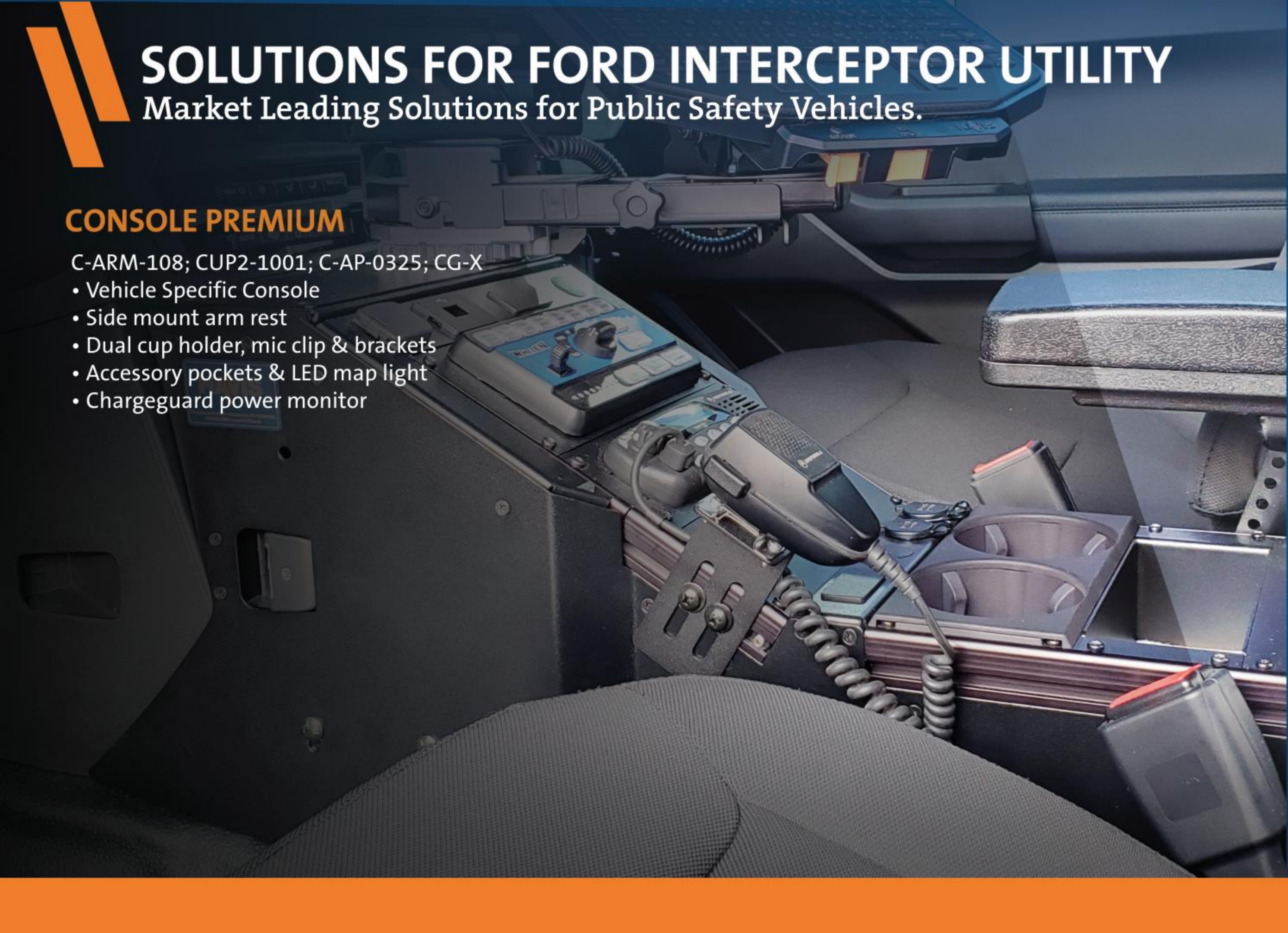

SOLUTIONS



CONSOLE & TABLET

C-DMM-3015; PKG-KBM-108

- Flip-up dash mount, holds 12 lbs
- Passenger access
- Havis USB keyboard & mount



CONSOLE & LAPTOP

C-HDM-204, C-MD-119

- Heavy duty telescoping side mount
- 11" Slide out arm & low profile rotation
- 180° horizontal rotation



CONSOLE & TOUCH SCREEN

C-DMM-2018, TSD-101, PKG-KBM-108

- Flip-up dash mount, holds 4 lbs
- Passenger view
- Havis USB keyboard & mount

FEATURED CONSOLES

EXTRA STURDY & ANGLED

C-VS-1012-INUT, C-PM-12X

- Vehicle Specific 22" console
- Low profile & angled
- Optional rear HVAC relocation plate
- Optional Drop-In Printer Mounts

THE NEXT GENERATION CONSOLE

- Low profile & angled
- Vehicle Specific design
- Sleek Styling
- Modern features



HORIZONTAL & DEEP CONSOLE

C-VS-0618-INUT, C-PM-12X

- Vehicle Specific 24" console
- Flat & deep design for taller radios
- Optional Drop-In Printer Mounts

LOW PROFILE

C-VS-1400-INUT-1

- Vehicle Specific 14" console
- Low profile & angled
- Mounts to OEM tunnel plate
- Access to factory controls

DASH MOUNT SOLUTIONS

PREMIUM DASH MOUNT

C-DMM-3015; PKG-KBM-108

- Flip-up dash mount
- 12 lb carrying weight
- Secure dual action latch
- Access to vehicle controls
- Driver & passenger access
- No drill solution
- 30 minute install
- Havis keyboard & mount

DASHMOUNT

TOUCH SCREEN DASH MOUNT

C-DMM-2018, TSD-101; PKG-KBM-108

- Flip-up dash mount
- 4 lb carrying weight
- Landscape or portrait viewing
- Access to vehicle controls
- Driver & passenger access
- Havis keyboard & mount



PEDESTAL MOUNT SOLUTIONS

PREMIUM SOLUTION

PKG-PSM-3006; C-HDM-401

- Heavy duty base, pole, & side support
- Mounts to existing OEM seat bolts
- Swing arm & motion device

STANDARD SOLUTION

PKG-PSM-1006

- Heavy duty base, pole, tilt swivel & offset
- Mounts to existing OEM seat bolts

FLEXIBLE SOLUTION

PKG-FAM-119; C-FAM-301

- Flex Arm and seat mount
- Swivel ball on top holds 5lbs
- Optional quick release for easy discharge





STORAGE DRAWERS & TOPPERS

STORAGE SOLUTION

SBX-1002, SBX-1003, SBX-3003

- Modular
- Stackable
- Drawer height and lock options
- Accessories: Lids, Locks & Lights
- 40" x 20" footprint
- Vehicle Specific mounts



UPPER AND LOWER TRAY

C-TTP-INUT-1201, C-TTP-INUT-1201-80, C-TTP-INUT-4

- 6" space between trays
- Access to spare tire
- 80-lb and 200-lb strut options
- Vehicle Specific
- No Drill Solution

TRUNK TRAY

C-TTP-INUT-1200, C-TTP-INUT-1200-80

- 3" space between tray and tire
- Access to spare tire
- 80-lb and 200-lb strut options
- Vehicle Specific
- No Drill solution



K9 & PRISONER TRANSPORT SOLUTIONS

PREMIUM K9 TRANSPORT

K9-F28, K9-A-201; K9-A-104

- Modular for 1 or 2 dogs
- 46" in length
- Front slider door exit
- Window Guards & Door Panels
- Optional 10" window fan and mount
- Optional Heat Alarm Pro, Hot n Pop Pro
- Available in black or white



OPTIONAL DUAL DOG DIVIDER

K9-A-108, K9-A-108-B

- 50/50 and 60/40 divider positions
- Door for side egress
- Quick egress latch



SPORT

PREMIUM K9 PRISONER TRANSPORT

K9-F28-PT, K9-F28-PT-B

- 60/40 K9 and prisoner
- Prisoner behind driver
- Uses OEM seat & belt
- Emergency exit door
- Available in black or white



KEYBOARD MOUNTING SOLUTIONS



USB KEYBOARD & TOP MOUNT

KB-105

- USB & mounting pins for additional device
- Chiclet style keys
- Integrated touch pad
- Red backlit keys

BLUETOOTH KEYBOARD

KB-103

- Ultra-Thin design
- Fully sealed IP65 case
- Integrated touch pad
- Silicone rubber
- Red backlit keys
- USB & Bluetooth connectivity



USB KEYBOARD

KB-108

- IP65 rated silicone keyboard
- Integrated touch pad
- Shielded emergency key
- Standard USB connection
- Red backlit keys

DUAL AUTHENTICATION

KB-104

- Integrated Fingerprint reader
- USB & mounting pins for additional device
- Chiclet style keys
- Integrated touch pad
- Red backlit keys



VERSATILE SOLUTIONS



UNIVERSAL CRADLE & MOUNT

UT-301, C-MAG-100

- Universal cradle for 7" to 9" devices
- Portrait or landscape viewing
- Lock & key included
- 120-lb pull magnet mount

PHONE CRADLE & CUP HOLDER MOUNT

PKG-CUP-101

- Cup Holder Mount with 3.75" dual articulating arm
- Cup mount expands to 3.5" in diameter
- Extended Length for Truck Cup holder Mount
- Universal phone holder adjust from 2.25" to 3.75"
- Phone held with rubber grips & foam backing
- Phone holder quick release



PHONE CRADLE & MAGNET MOUNT

PKG-MAG-101

- 120-lb pull magnet mount
- 5.25" height
- Dual knuckle articulation
- Phone holder quick release

RUGGED PHONE MOUNT

PKG-WIN-102; PKG-WIN-101

- Industrial suction cup mounting
- Fully adjustable
- Quick release button
- Standard & telescoping 18" arm





HAVIS PHONE MIRRORING SOLUTION

HAVIS PHONE MIRRORING SOLUTION

TSD-101, DS-DA-604, C-DMM-3015, PKG-MAG-101, PKG-KBM-108

- Touch screen display
- USB-C hub
- Havis keyboard and keyboard mount
- Havis dash mount
- Havis magnetic phone mount

MIRRORING





FORD INTERCEPTOR UTILITY SOLUTIONS



HAVIS

SOLUTIONS FOR FORD INTERCEPTOR UTILITY

Market Leading Solutions for Public Safety Vehicles.

CONSOLE PREMIUM

C-ARM-102; C-CUP2-I; C-MCB; C-MAP-T-LED; C-AP-0325; CG-X

- Side mount arm rest
- Dual cup holder, mic clip & brackets
- Accessory pockets & LED map light
- Chargeguard power monitor



SOLUTIONS



CONSOLE & TABLET

C-DMM-3001; PKG-KBM-101

- Flip-up dash mount, holds 12 lbs
- Passenger access
- Havis USB keyboard & mount



CONSOLE & LAPTOP

C-HDM-204; C-MD-119

- Heavy duty telescoping side mount
- 11" Slide out arm & low profile rotation
- 180 degree horizontal rotation



CONSOLE & TOUCH SCREEN

C-DMM-2001; TSD-101; PKG-KBM-101

- Flip-up dash mount, holds 4 lbs
- Passenger view
- Havis USB keyboard & mount

FEATURED CONSOLES

EXTRA STURDY & ANGLED

C-VS-0812-INUT-1

- Vehicle Specific 20" angled console
- Low profile, angled for equipment visibility
- Technology mounts directly to console
- 2 Lighter plugs with an option for a 3rd





MOST POPULAR CONSOLE

C-VS-1308-INUT-1

- Vehicle specific 21" console
- Low profile & angled for equipment visibility
- Side or top mount for technology



LOW PROFILE & PRINTER

C-VS-0810-INUT-PM

- Vehicle specific 18"
- Low profile, angled
- Built-in radio speaker mounting
- Integrated Pocketjet printer

DASH MOUNT SOLUTIONS

PREMIUM DASH MOUNT

C-DMM-3001; PKG-KBM-101

- Flip-up dash mount
- 12 lb carrying weight
- Secure dual action latch
- Access to vehicle controls
- Driver & passenger access
- No drill solution
- 30 minute install
- Havis keyboard & mount



The image shows the interior of a Ford Interceptor Utility vehicle. A large, black, rectangular touch screen is mounted on the dashboard, displaying a Windows-style Start menu with various application icons. Below the screen is a Havis keyboard with a numeric keypad and function keys. The steering wheel is visible on the left, featuring the Ford logo and 'AIR BAG' text. The dashboard and center console are dark-colored with various controls and buttons.

TOUCH SCREEN DASH MOUNT

C-DMM-2001; TSD-101; PKG-KBM-101

- Flip-up dash mount
- 4 lb carrying weight
- Landscape or portrait viewing
- Access to vehicle controls
- Driver & passenger access
- Havis keyboard & mount

PEDESTAL MOUNT SOLUTIONS

PREMIUM SOLUTION

PKG-PSM-353

- Heavy duty base, pole, & side support
- Mounts to existing OEM seat bolt
- Front release sliding swing arm

STANDARD SOLUTION

PKG-PSM-153

- Heavy duty base, pole, tilt swivel & offset
- Mounts to existing OEM seat bolt

FLEXIBLE SOLUTION

PKG-FAM-104; C-FAM-301

- Flex Arm and seat mount
- Swivel ball on top holds 5lbs
- Quick release for easy discharge





STORAGE SOLUTIONS

TRUNK TRAY & STORAGE SOLUTION

C-TTP-INUT-2; C-TTP-INUT-200

- Premium fold up trunk plate
- Fold up equipment platform for mounting electronic components



K9 & PRISONER TRANSPORT SOLUTIONS

PREMIUM K9 TRANSPORT

K9-F18; K9-A-201; K9-A-104

- Single large K9 enclosure
- Large side entry: driver & passenger
- Front slider door escape
- Window guards & door panels
- 10" window fan & mount
- Heat Alarm Pro
- Remote door pop
- Siren & light remote activation



PREMIUM PRISONER TRANSPORT

K9-F18-PT; K9-A-201; K9-A-104

- Passenger side prisoner compartment
- Driver side single K9 enclosure
- Front slider door escape
- Window guards & door panels
- 10" window fan & mount



KEYBOARD MOUNTING SOLUTIONS

USB KEYBOARD & TOP MOUNT

KB-101; C-MAG-100

- Ultra-thin design
- Fully sealed IP65 case
- Integrated touch pad
- Silicone rubber
- Red backlit keys
- USB connectivity

BLUETOOTH KEYBOARD & MAGNETIC MOUNT

KB-103; C-MAG-100

- Ultra-thin design
- Fully sealed IP65 case
- Integrated touch pad
- Silicone rubber
- Red backlit keys
- USB connectivity



USB KEYBOARD & SIDE MOUNT

PKG-KBM-101

- Ultra-thin design
- Integrated touch pad
- Silicone rubber keypad
- Red backlit keys
- USB & Bluetooth connectivity

DUAL AUTHENTICATION & SIDE MOUNT

KB-104; C-KBM-201; CM006331; C-MD-204

- Integrated fingerprint reader
- USB & mounting pins for additional device
- Integrated touch pad
- Silicone rubber keypad
- Red backlit keys



VERSATILE SOLUTIONS



UNIVERSAL CRADLE & MOUNT

UT-301; C-MAG-100

- Universal cradle for 7" to 9" devices
- Portrait or landscape viewing
- Lock & key included
- 140 lb pull magnetic mount

RUGGED PHONE MOUNT

PKG-WIN-102; PKG-WIN-101

- Industrial suction cup mounting
- Fully adjustable
- Quick release button
- Standard & telescoping 18" arm





FORD FUSION SOLUTIONS



HAVIS

The image shows the interior of a vehicle, specifically the center console area. The console is black and features a blue control panel with a knob and buttons. To the right of the control panel is a microphone mounted on a base labeled "MAGNETIC MIC". Further right is a dual cup holder. Below the cup holder is a power outlet with a red indicator light. The console is mounted on a black seat. In the background, a steering wheel and dashboard are visible. The overall lighting is dim, with a blue tint.

SOLUTIONS FOR FORD FUSION

Market Leading Solutions for Public Safety Vehicles.

CONSOLE PREMIUM

C-ARM-108; C-CUP2-I; CG-X

- Side mount arm rest
- Dual cup holder, mic clip & brackets
- Accessory pockets & LED map light
- Chargeguard power monitor

SOLUTIONS



CONSOLE & TABLET

C-DMM-3008; PKG-KBM-101

- Flip-up dash mount, holds 12 lbs
- Passenger access
- Havis USB keyboard & mount



CONSOLE & LAPTOP

C-HDM-204; C-MD-119

- Heavy duty telescoping side mount
- 11" slide out arm & low profile rotation
- 180° horizontal rotation



CONSOLE & TOUCH SCREEN

C-DMM-2013; TSD-101; PKG-KBM-101

- Flip-up dash mount, holds 4 lbs
- Passenger view
- Havis USB keyboard & mount



FEATURED CONSOLE

CONSOLE



EXTRA STURDY & CONTOURED

C-VS-1307-FUS-1

- Vehicle specific 20" console
- Low profile design
- Angled towards dash
- Side mounting for computer

DASH MOUNT SOLUTIONS

PREMIUM DASH MOUNT

C-DMM-3008

- Flip-up dash mount
- 12 lb carrying weight
- Secure dual action Latch
- Access to vehicle controls
- Driver & passenger access
- No drill solution
- 30 minute install
- Havis keyboard & mount



The image shows the driver's side interior of a Ford Fusion. A large, black touch screen is mounted on the dashboard, displaying a police officer standing next to a police car. Below the screen is a Havis control panel with various buttons and a gear shifter. To the right of the gear shifter is a Havis keyboard and mouse. The steering wheel has the Ford logo and 'AIRBAG' text. The dashboard features a speedometer and other gauges. The overall scene is dimly lit, suggesting a nighttime or low-light environment.

TOUCH SCREEN DASH MOUNT

C-DMM-2013; TSD-101; PKG-KBM-101

- Flip-up dash mount
- 4 lb carrying weight
- Landscape or portrait viewing
- Access to vehicle controls
- Driver & passenger access
- Havis keyboard & mount

KEYBOARD MOUNTING SOLUTIONS

USB KEYBOARD & TOP MOUNT

KB-101; C-MAG-100

- Ultra-thin design
- Fully sealed IP65 case
- Integrated touch pad
- Silicone rubber
- Red backlit keys
- USB connectivity

BLUETOOTH KEYBOARD & MAGNETIC MOUNT

KB-103; C-MAG-100

- Ultra-thin design
- Fully sealed IP65 case
- Integrated touch pad
- Silicone rubber
- Red backlit keys
- USB connectivity



USB KEYBOARD & SIDE MOUNT

PKG-KB-201; CM006331;
C-MD-204

- Ultra-thin design
- Integrated touch pad
- Silicone rubber keypad
- Red backlit keys
- USB & Bluetooth connectivity

DUAL AUTHENTICATION & SIDE MOUNT

KB-104; C-KBM-201; CM006331; C-MD-204

- Integrated fingerprint reader
- USB & mounting pins for additional device
- Integrated touch pad
- Silicone rubber keypad
- Red backlit keys



VERSATILE SOLUTIONS



UNIVERSAL CRADLE & MOUNT

UT-301; C-MAG-100

- Universal Cradle for 7" to 9" devices
- Portrait or Landscape viewing
- Lock & key Included
- 140 lb pull Magnetic Mount

RUGGED PHONE MOUNT

PKG-WIN-102; PKG-WIN-101

- Industrial suction cup mounting
- Fully adjustable
- Quick release button
- Standard & telescoping 18" arm





FORD F-150 SOLUTIONS



HAVIS



SOLUTIONS FOR FORD F-150

Market Leading Solutions for Public Safety Vehicles.

CONSOLE PREMIUM

C-ARM-102; C-CUP2-I; C-AP-1395; CG-X

- Side mount arm rest
- Dual cup holder, mic clip & brackets
- Accessory pockets & LED map light
- Chargeguard power monitor

SOLUTIONS



CONSOLE & TABLET

C-DMM-3006; PKG-KBM-101

- Flip-up dash mount, holds 12 lbs
- Passenger access
- Havis USB keyboard & mount



CONSOLE & LAPTOP

C-HDM-204; C-MD-119

- Heavy duty telescoping side mount
- 11" slide out arm & low profile rotation
- Side mounted arm rest



CONSOLE & TOUCH SCREEN

C-DMM-2006; TSD-101; PKG-KBM-101

- Flip-up dash Mount, holds 4 lbs
- Passenger view
- Havis USB keyboard & mount



FEATURED CONSOLES

EXTRA STURDY & CONTOURED

C-VS-3000-F150-1

- Vehicle specific 30" console
- OEM aux panel integration
- Built-in radio speaker mounting
- Internal telescoping pole mounting

The image shows the interior of a vehicle, specifically the center console area. A custom console is installed, featuring a black plastic housing. The console is open, revealing a storage compartment filled with colorful file folders (yellow, blue, red, and green). Below the storage compartment, there is a writing surface with a clipboard. To the right of the writing surface, a Brother PocketJet 9 printer is integrated into the console. The printer is black and has a white sheet of paper emerging from it. The console is mounted in the center of the vehicle, between the driver and passenger seats. The background shows the steering wheel, dashboard, and center console of the vehicle. The overall lighting is dim, with a blue tint, suggesting an interior view at night or in a dimly lit environment.

UNIVERSAL CONSOLE

C-3012-PM

- Lockable file storage
- Easy access writing surface & clipboard
- Integrated PocketJet printer
- Vented speaker mounting areas

DASH MOUNT SOLUTIONS

PREMIUM DASH MOUNT

C-DMM-3006

- Flip-up dash mount
- 12 lb carrying weight
- Secure dual action latch
- Access to vehicle controls
- Driver & passenger access
- No drill solution
- 30 minute install
- Havis keyboard & mount



The image shows the interior of a Ford F-150. A Havis touch screen dash mount is installed on the dashboard, displaying a software interface with a map and a list of items. Below the screen is a Havis keyboard mounted on a flip-up dash mount. A Motorola radio is also visible on the dashboard. The steering wheel and air vents are also visible.

TOUCH SCREEN DASH MOUNT

C-DMM-2006; TSD-101; PKG-KB-201

- Flip-up dash mount
- 4 lb carrying weight
- Landscape or portrait viewing
- Access to vehicle controls
- Driver & passenger access
- Havis keyboard & mount

PEDESTAL MOUNT SOLUTIONS

PREMIUM SOLUTION

PKG-PSM-385

- Heavy duty base, pole, & side support
- Mounts to existing OEM seat bolt
- Swing arm & motion device

STANDARD SOLUTION

PKG-PSM-185

- Heavy duty base, pole, tilt swivel & offset
- Mounts to existing OEM seat bolt

FLEXIBLE SOLUTION

PKG-FAM-114; C-FAM-301

- Flex Arm and seat mount
- Swivel ball on top holds 5lbs
- Quick release for easy discharge

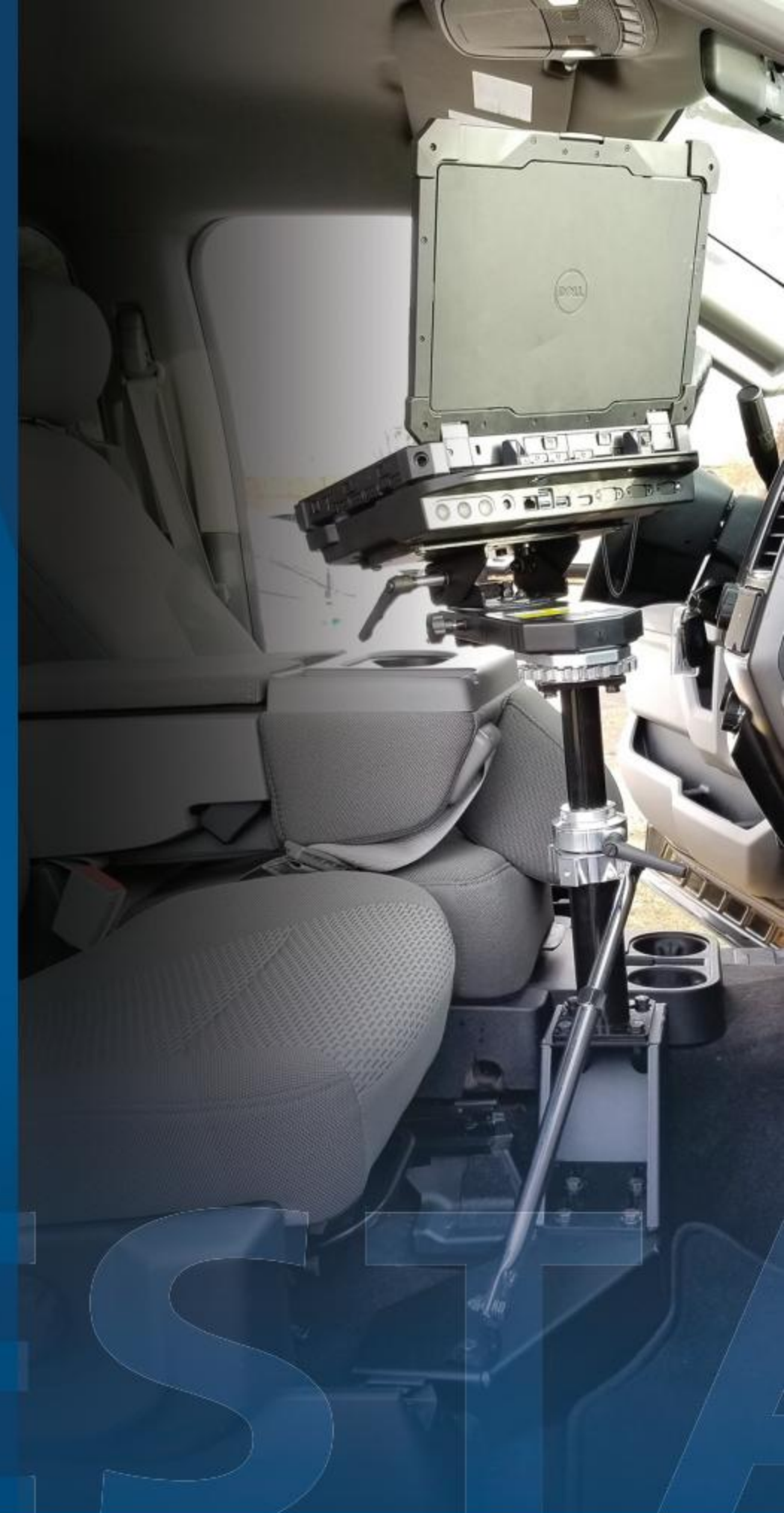





K9 TRANSPORT SOLUTIONS

PREMIUM K9 TRANSPORT

K9-F23; K9-A-201; K9-A-104

- Single large K9 enclosure
- Large side entry: Driver and Passenger
- Front slider door escape
- Window guards and door panels
- Heat Alarm Pro
- Siren & Light remote activation





- Secure lockable storage
- Setup for Hot n Pop
- OEM heat and AC integration
- Access to OEM jack

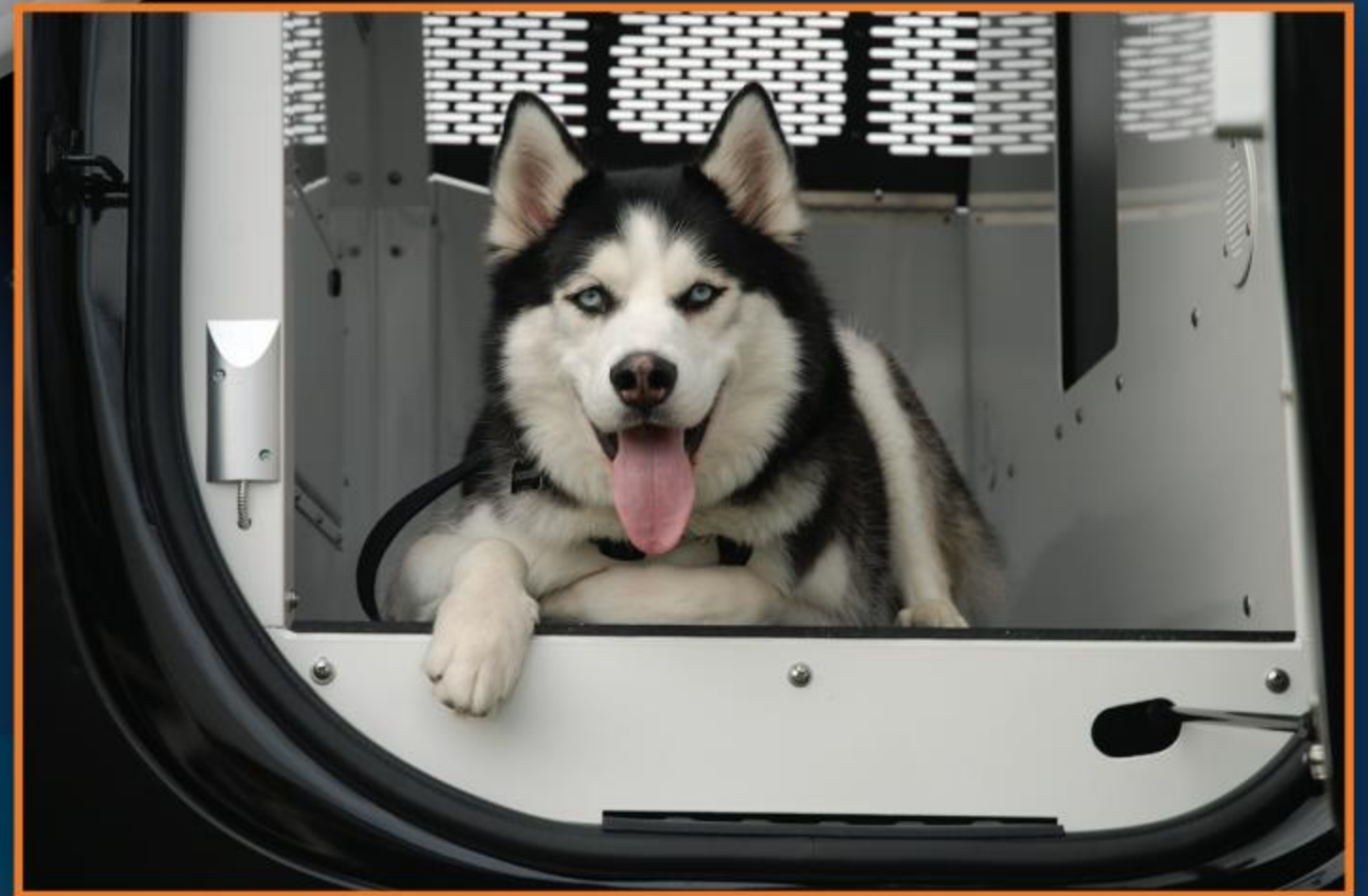

TRANS

KEYBOARD MOUNTING SOLUTIONS

USB KEYBOARD & TOP MOUNT

KB-101; C-MAG-100

- Ultra-thin design
- Fully sealed IP65 case
- Integrated touch pad
- Silicone rubber
- Red backlit keys
- USB connectivity

BLUETOOTH KEYBOARD & MAGNETIC MOUNT

KB-103; C-MAG-100

- Ultra-thin design
- Fully sealed IP65 case
- Integrated touch pad
- Silicone rubber
- Red backlit keys
- USB connectivity



USB KEYBOARD & SIDE MOUNT

PKG-KBM-101

- Ultra-thin design
- Integrated touch pad
- Silicone rubber keypad
- Red backlit keys
- USB & Bluetooth connectivity

DUAL AUTHENTICATION & SIDE MOUNT

KB-104; C-KBM-201; CM006331; C-MD-204

- Integrated fingerprint reader
- USB & mounting pins for additional device
- Integrated touch pad
- Silicone rubber keypad
- Red backlit keys



VERSATILE SOLUTIONS



UNIVERSAL CRADLE & MOUNT

UT-301; C-MAG-100

- Universal Cradle for 7" to 9" devices
- Portrait or landscape viewing
- Lock & key Included
- 140 lb pull Magnetic Mount

RUGGED PHONE MOUNT

PKG-WIN-102; PKG-WIN-101

- Industrial suction cup mounting
- Fully adjustable
- Quick release button
- Standard & telescoping 18" arm





DODGE CHARGER SOLUTIONS

DODGE  **HAVIS**



SOLUTIONS FOR DODGE CHARGER

Market Leading Solutions for Public Safety Vehicles.

CONSOLE PREMIUM

C-ARM-108; C-CUP2-I; C-MCB; C-MAP-T-LED; C-AP-0325; CG-X

- Side mount flip-up arm rest
- Dual cup holder, mic clip & brackets
- Accessory pockets & LED Map Light
- Chargeguard power monitor
- Low profile & angled



WARNING! Do Not use
computer while driving
vehicle.

SOLUTIONS



CONSOLE & TABLET

C-DMM-3005; PKG-KBM-101

- Flip-up dash mount, holds 12 lbs
- Passenger access
- Havis USB keyboard & mount



CONSOLE & LAPTOP

C-HDM-303; C-MD-204

- Heavy duty offset platform
- 45° vertical tilt
- 180° horizontal rotation



CONSOLE & TOUCH SCREEN

C-DMM-2004; TSD-101; PKG-KBM-101

- Flip-up dash mount, holds 4 lbs
- Passenger view
- Havis USB keyboard & mount

FEATURED CONSOLES

MOST POPULAR CONSOLE

C-VS-2400-CHGR-2

- Dodge factory option
- Integrates OEM aux panel & lighter plugs
- Seamless fit to dash contour
- Adjustable flip-up armrest





LOW PROFILE WITH BUILT-IN PRINTER MOUNT

C-VS-0909-CHGR-PM

- Vehicle specific 18" console
- Low profile, angled
- Integrated PocketJet printer
- Side-mounted flip-up arm rest



EXTRA STURDY & ANGLED

C-VS-0809-CHGR-1

- Vehicle specific 17" console
- Computer mounting platform
- Low profile design
- 2 lighter plugs with option for a third

DASH MOUNT SOLUTIONS

PREMIUM DASH MOUNT

C-DMM-3005

- Flip-up dash mount
- 12 lb carrying weight
- Secure dual action Latch
- Access to vehicle controls
- Driver & passenger access
- No drill solution
- 30 minute install
- Havis keyboard & mount

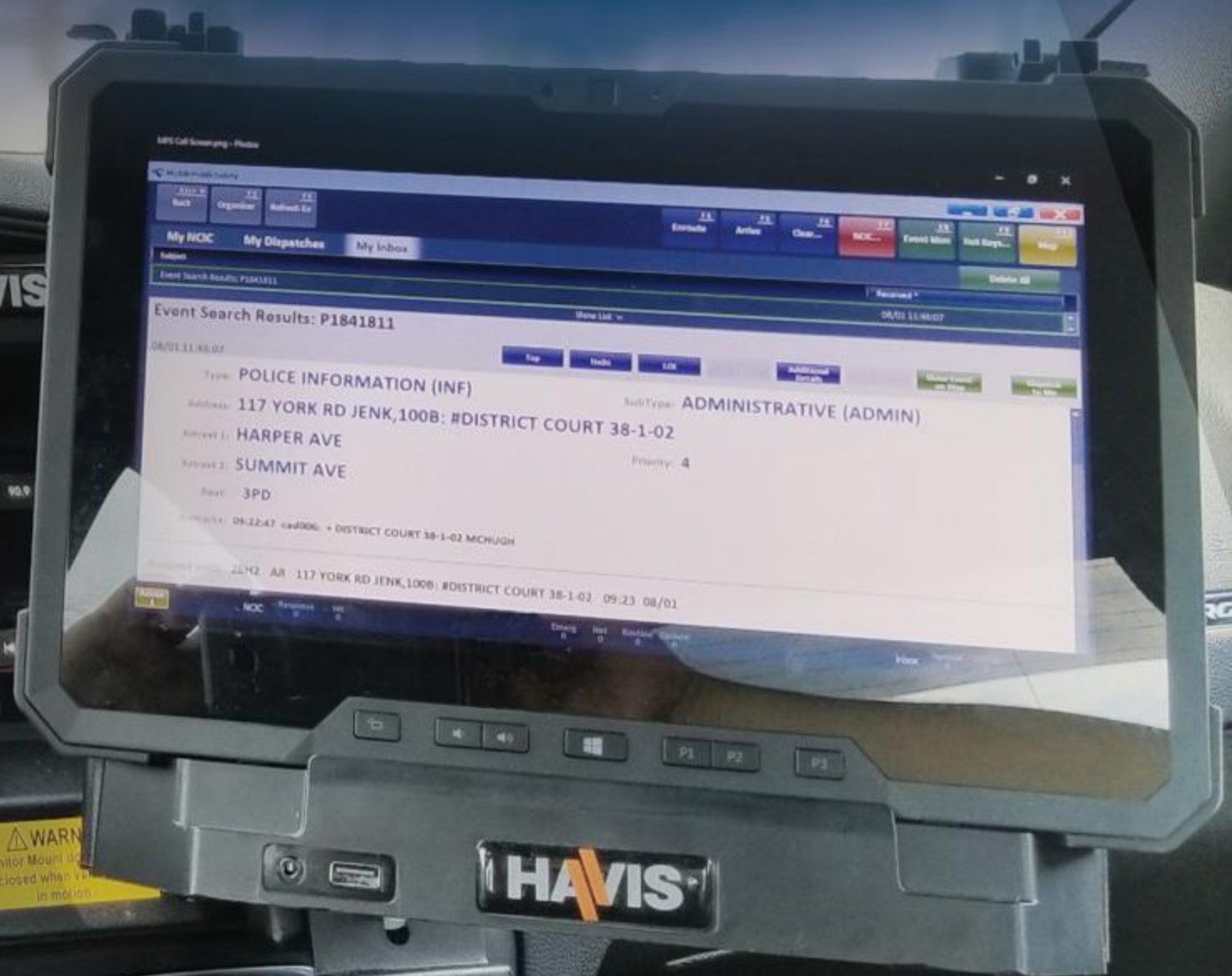

TOUCH SCREEN DASH MOUNT

C-DMM-2004; TSD-101; PKG-KBM-101

- Flip-up dash mount
- 4 lb carrying weight
- Landscape or portrait viewing
- Access to vehicle controls
- Driver & passenger access
- Havis keyboard & mount



PEDESTAL MOUNT SOLUTIONS

PREMIUM SOLUTION

PKG-PSM-368

- Heavy Duty base, pole, & side support
- Mounts to existing OEM seat bolt
- Swing arm & motion device

STANDARD SOLUTION

PKG-PSM-168

- Heavy Duty base, pole, tilt swivel & offset
- Mounts to existing OEM seat bolt

FLEXIBLE SOLUTION

PKG-FAM-111; C-FAM-301

- Flex Arm and seat mount
- Swivel ball on top holds 5lbs
- Quick release for easy discharge







K9 TRANSPORT SOLUTION

K9 TRANSPORT SOLUTION

K9-D24; K9-A-201; K9-A-104

- Single large K9 enclosure
- Large side entry: driver & passenger
- Front slider door escape
- Window guards & door panels
- 10" Window fan & mount
- Heat Alarm Pro
- Remote door pop
- Siren & light remote activation

stc

STORAGE SOLUTIONS

SPACE SAVING DESIGN

C-TFD-CHGR-2

- Maximizes cargo space
- Easy removable mounting base
- Easy access pull out tray



EASY EQUIPMENT MOUNTING

C-TSM-CHGR

- Hinged flip down mounting platform
- Secure locking latch
- 15-minute install



ORANGE

KEYBOARD MOUNTING SOLUTIONS

USB KEYBOARD & TOP MOUNT

KB-101; C-MAG-100

- Ultra-thin design
- Fully sealed IP65 case
- Integrated touch pad
- Silicone rubber
- Red backlit keys
- USB connectivity

BLUETOOTH KEYBOARD & MAGNETIC MOUNT

KB-103; C-MAG-100

- Ultra-thin design
- Fully sealed IP65 case
- Integrated touch pad
- Silicone rubber
- Red backlit keys
- USB connectivity



USB KEYBOARD & SIDE MOUNT

PKG-KBM-101

- Ultra-thin design
- Integrated touch pad
- Silicone rubber keypad
- Red backlit keys
- USB & Bluetooth connectivity

DUAL AUTHENTICATION & SIDE MOUNT

KB-104; C-KBM-201; CM006331; C-MD-204

- Integrated fingerprint reader
- USB & mounting pins for additional device
- Integrated touch pad
- Silicone rubber keypad
- Red backlit keys



VERSATILE SOLUTIONS



UNIVERSAL CRADLE & MOUNT

UT-301, C-MAG-100

- Universal Cradle for 7" to 9" devices
- Portrait or Landscape viewing
- Lock & key Included
- 140 lb pull Magnetic Mount

RUGGED PHONE MOUNT

PKG-WIN-102; PKG-WIN-101

- Industrial suction cup mounting
- Fully adjustable
- Quick release button
- Standard & telescoping 18" arm





DODGE DURANGO SOLUTIONS

DODGE

HAVIS



SOLUTIONS FOR DODGE DURANGO

Market Leading Solutions for Public Safety Vehicles.

CONSOLE PREMIUM

C-ARM-102; C-CUP2-I; CG-X

- Side mount arm rest
- Dual cup holder, mic clip & brackets
- Accessory pockets & LED map light
- Chargeguard power monitor



SOLUTIONS



CONSOLE & TABLET

C-DMM-3004; PKG-KBM-101

- Flip-up dash Mount, holds 12 lbs
- Passenger access
- Havis USB keyboard & mount



CONSOLE & LAPTOP

C-HDM-204; C-MD-119

- Heavy duty telescoping side mount
- 11" slide out arm & low profile rotation
- 180° horizontal rotation



CONSOLE & TOUCH SCREEN

C-DMM-2015; TSD-101; PKG-KBM-101

- Flip-up dash mount, holds 4 lbs
- Passenger view
- Havis USB keyboard & mount

FEATURED CONSOLE

EXTRA STURDY & CONTOURED

C-VS-2000-DUR-1

- Vehicle specific 20" console
- OEM aux panel integration
- OEM terrain control mounting
- Seamless factory shifter mounting





WARNING
DO NOT MOUNT ANY EQUIPMENT
THAT WILL INTERFERE WITH THE
DEPLOYMENT OF EITHER AIR BAG

DASH MOUNT SOLUTIONS

PREMIUM DASH MOUNT

C-DMM-3004

- Flip-up dash mount
- 12 lb carrying weight
- Secure dual action Latch
- Access to vehicle controls
- Driver & passenger access
- No drill solution
- 30 minute install
- Havis keyboard & mount



TOUCH SCREEN DASH MOUNT

C-DMM-2015; TSD-101; PKG-KBM-101

- Flip-up dash mount
- 4 lb carrying weight
- Landscape or portrait viewing
- Access to vehicle controls
- Driver & passenger access
- Havis keyboard & mount



PEDESTAL MOUNT SOLUTIONS

PREMIUM SOLUTION

PKG-PSM-345

- Heavy duty base, pole, & side support
- Mounts to existing OEM seat bolt
- Swing arm & motion device

STANDARD SOLUTION

PKG-PSM-145

- Heavy duty base, pole, tilt swivel & offset
- Mounts to existing OEM seat bolt

FLEXIBLE SOLUTION

PKG-FAM-118; C-FAM-301

- Flex Arm and seat mount
- Swivel ball on top holds 5lbs
- Quick release for easy discharge





D O D G E D U R A N G O

K9 TRANSPORT SOLUTIONS

PREMIUM K9 TRANSPORT

K9-D25; K9-A-201; K9-A-104

- Single large K9 enclosure
- Large slide entry: driver & passenger
- Front slider door escape
- Window guards & door panels
- 10" window fan & mount
- Heat Alarm Pro
- Remote door pop
- Siren & light activation





TRANSPORT

D O D G E D U R A N G O

KEYBOARD MOUNTING SOLUTIONS

USB KEYBOARD & TOP MOUNT

KB-101; C-MAG-100

- Ultra-thin design
- Fully sealed IP65 case
- Integrated touch pad
- Silicone rubber
- Red backlit keys
- USB connectivity

BLUETOOTH KEYBOARD & MAGNETIC MOUNT

KB-103; C-MAG-100

- Ultra-thin design
- Fully sealed IP65 case
- Integrated touch pad
- Silicone rubber
- Red backlit keys
- USB connectivity



USB KEYBOARD & SIDE MOUNT

PKG-KB-201; CM006331;
C-MD-204

- Ultra-thin design
- Integrated touch pad
- Silicone rubber keypad
- Red backlit keys
- USB & Bluetooth connectivity

DUAL AUTHENTICATION & SIDE MOUNT

KB-104; C-KBM-201; CM006331; C-MD-204

- Integrated fingerprint reader
- USB & mounting pins for additional device
- Integrated touch pad
- Silicone rubber keypad
- Red backlit keys





VERSATILE SOLUTIONS



UNIVERSAL CRADLE & MOUNT

UT-301; C-MAG-100

- Universal Cradle for 7" to 9" devices
- Portrait or Landscape viewing
- Lock & key Included
- 140 lb pull Magnetic Mount

RUGGED PHONE MOUNT

PKG-WIN-102; PKG-WIN-101

- Industrial suction cup mounting
- Fully adjustable
- Quick release button
- Standard & telescoping 18" arm





CHEVY TAHOE SOLUTIONS



HAVIS

A photograph of the interior of a Chevy Tahoe, focusing on the center console. The console is equipped with a HAVIS (Heavy Duty Vehicle Interface System) unit, which is a black, ruggedized control panel. The HAVIS unit features a side-mounted arm rest, a dual cup holder, a microphone, and various buttons and controls. The background shows the car's dashboard, steering wheel, and leather seats. The overall lighting is dim, highlighting the HAVIS unit.

SOLUTIONS FOR CHEVY TAHOE

Market Leading Solutions for Public Safety Vehicles.

CONSOLE PREMIUM

C-ARM-102; C-CUP2-I-A06; CG-X

- Side mount arm rest
- Dual cup holder, mic clip & brackets
- Accessory pockets & LED map light
- Chargeguard power monitor

SOLUTIONS



CONSOLE & TABLET

C-DMM-3003; PKG-KBM-101

- Flip-up dash Mount, holds 12 lbs
- Passenger access
- Havis USB keyboard & mount



CONSOLE & LAPTOP

C-HDM-204; C-MD-119

- Heavy duty telescoping side mount
- 11" slide out arm & low profile rotation
- 180 degree horizontal rotation



CONSOLE & TOUCH SCREEN

C-DMM-2014; TSD-101; PKG-KBM-101

- Flip-up dash mount, holds 4 lbs
- Passenger view
- Havis USB keyboard & mount

FEATURED CONSOLES

MOST POPULAR CONSOLE

C-VS-1013-TAH-1

- Vehicle specific 23" console
- OEM aux panel integration
- Built-in radio speaker mounting
- 2 lighter plugs with 3rd option

WARNING
DO NOT MOUNT ANY EQUIPMENT
THAT WILL INTERFERE WITH THE
DEPLOYMENT OF EITHER AIR BAG



WIDE BODY CONSOLE

C-VS-2000-TAH-2

- Vehicle specific 20" console
- OEM aux panel integration
- Internal telescoping pole mounting
- Built in file storage



UNIVERSAL CONSOLE

C-3012-PM

- Lockable file storage
- Easy access writing surface & clipboard
- Integrated PocketJet printer
- Vented speaker mounting areas

DASH MOUNT SOLUTIONS

PREMIUM DASH MOUNT

C-DMM-3003

- Flip-up dash mount
- 12 lb carrying weight
- Secure dual action Latch
- Access to vehicle controls
- Driver & passenger access
- 30 minute install
- Havis keyboard & mount



TOUCH SCREEN DASH MOUNT

C-DMM-2014; TSD-101; PKG-KBM-101

- Flip-up dash mount
- 4 lb carrying weight
- Landscape or portrait viewing
- Access to vehicle controls
- Driver & passenger access
- Havis keyboard & mount

PEDESTAL MOUNT SOLUTIONS

PREMIUM SOLUTION

PKG-PSM-376

- Heavy duty base, pole, & side support
- Mounts to existing OEM seat hooks
- Swing arm & motion device

STANDARD SOLUTION

PKG-PSM-176

- Heavy duty base, pole, tilt swivel & offset
- Mounts to existing OEM seat hooks

FLEXIBLE SOLUTION

PKG-FAM-113; C-FAM-301

- Flex Arm and seat mount
- Swivel ball on top holds 5lbs
- Quick release for easy discharge







STORAGE SOLUTIONS

TOTAL TRUNK SECURITY

C-SBX-101; C-SBX-101-KIT-3; C-SBX-903

- Lockable secure storage
- Rear partition
- Space saving solution
- Vented for maximum airflow

For over 80 years, Havis has been the market leader in Public Safety mobile solutions. Havis products are built to the highest safety and quality standards and are designed with comfort in mind.

K9 & PRISONER TRANSPORT SOLUTIONS

PREMIUM K9 TRANSPORT

K9-C23; K9-A-201; K9-A-104

- Single large K9 enclosure
- Large slide entry: Driver & passenger
- Front slider door escape
- Window guards & door panels
- 10" window fan & mount
- Heat Alarm Pro
- Remote door pop
- Siren & light activation



PREMIUM PRISONER TRANSPORT

K9-C23-PT; K9-A-201; K9-A-104

- Passenger side prisoner compartment
- Driver side single K9 enclosure
- Front slider door escape
- Window guards & door panels
- 10" window fan & mount

KEYBOARD MOUNTING SOLUTIONS

USB KEYBOARD & TOP MOUNT

KB-101; C-MAG-100

- Ultra-thin design
- Fully sealed IP65 case
- Integrated touch pad
- Silicone rubber
- Red backlit keys
- USB connectivity

BLUETOOTH KEYBOARD & MAGNETIC MOUNT

KB-103; C-MAG-100

- Ultra-thin design
- Fully sealed IP65 case
- Integrated touch pad
- Silicone rubber
- Red backlit keys
- USB connectivity



USB KEYBOARD & SIDE MOUNT

PKG-KBM-101

- Ultra-thin design
- Integrated touch pad
- Silicone rubber keypad
- Red backlit keys
- USB & Bluetooth connectivity

DUAL AUTHENTICATION & SIDE MOUNT

KB-104; C-KBM-201; CM006331; C-MD-204

- Integrated fingerprint reader
- USB & mounting pins for additional device
- Integrated touch pad
- Silicone rubber keypad
- Red backlit keys





VERSATILE SOLUTIONS



UNIVERSAL CRADLE & MOUNT

UT-301; C-MAG-100

- Universal Cradle for 7" to 9" devices
- Portrait or Landscape viewing
- Lock & key Included
- 140 lb pull Magnetic Mount

RUGGED PHONE MOUNT

PKG-WIN-102; PKG-WIN-101

- Industrial suction cup mounting
- Fully adjustable
- Quick release button
- Standard & telescoping 18" arm



A close-up photograph of a commercial truck's front left side. The truck is dark-colored and has a prominent chrome headlight that is illuminated, casting a warm glow. Below the headlight is a large, multi-spoke alloy wheel with a black tire. The truck is parked on a gravel surface. The background is slightly blurred, showing more of the truck's body and a red component. The overall lighting is dramatic, with strong highlights and deep shadows.

COMMERCIAL TRUCK & VAN SOLUTIONS

HAVIS

A photograph of a commercial truck's interior, focusing on a custom console. The console is a large, dark-colored unit with a side-mounted arm rest, two cup holders, and a central control panel. A laptop is mounted on top of the console, and a power monitor is visible on the side. The background shows the truck's dashboard and steering wheel.

COMMERCIAL TRUCK AND VAN SOLUTIONS

Market Leading Solutions for Enterprise Utility.

CONSOLE PREMIUM

C-ARM-102, C-CUP2-I, C-AP-1395, CG-X

- Side mount arm rest
- Dual cup holder, mic clip & brackets
- Accessory pockets & LED map light
- Chargeguard power monitor

SOLUTIONS



CONSOLE & TABLET

- Flip-up Dash Mount, holds 12 lbs
- Passenger access
- Havis USB keyboard & mount



CONSOLE & LAPTOP

- Heavy duty telescoping side mount
- 11" slide out arm & low profile rotation
- Side mounted arm rest



CONSOLE & TOUCH SCREEN

- Flip-up Dash Mount, holds 4 lbs
- Passenger view
- Havis USB keyboard & mount

The image shows the interior of a commercial vehicle, likely a truck or van, with a focus on the driver's seat. A large, ruggedized tablet is mounted on the dashboard, displaying the HAVIS logo. The tablet is a Panasonic model, as indicated by the text at the bottom of the screen. Below the tablet, a keyboard is mounted on a tray, also featuring the HAVIS logo. The steering wheel is visible on the left, with the Chevrolet logo and 'AIRBAG' text. The dashboard includes several gauges and a small display screen. The overall scene is set against a background of a city street, suggesting a commercial or delivery environment.

COMMERCIAL TRUCK & VAN SOLUTIONS



UNIVERSAL CONSOLE

C-3012-PM

- Lockable file storage
- Easy access writing surface & clipboard
- Integrated PocketJet printer
- Vented speaker mounting areas

DASH MOUNT SOLUTIONS

PREMIUM DASH MOUNT

- Flip-up dash mount
- 12 lb carrying weight
- Secure dual action Latch
- Access to vehicle controls
- Driver & passenger access
- No drill solution
- 30 minute install
- Havis keyboard & mount



- Flip-up dash mount
- 4 lb carrying weight
- Landscape or portrait viewing
- Access to vehicle controls
- Driver & passenger access
- Havis keyboard & mount

PEDESTAL MOUNT SOLUTIONS

PREMIUM SOLUTION

- Heavy duty base, pole, & side support
- Mounts to existing OEM seat bolt
- Swing arm & motion device

STANDARD SOLUTION

- Heavy duty base, pole, tilt swivel & offset
- Mounts to existing OEM seat bolt

FLEXIBLE SOLUTION

- Flex Arm and seat mount
- Swivel ball on top holds 5lbs
- Quick release for easy discharge

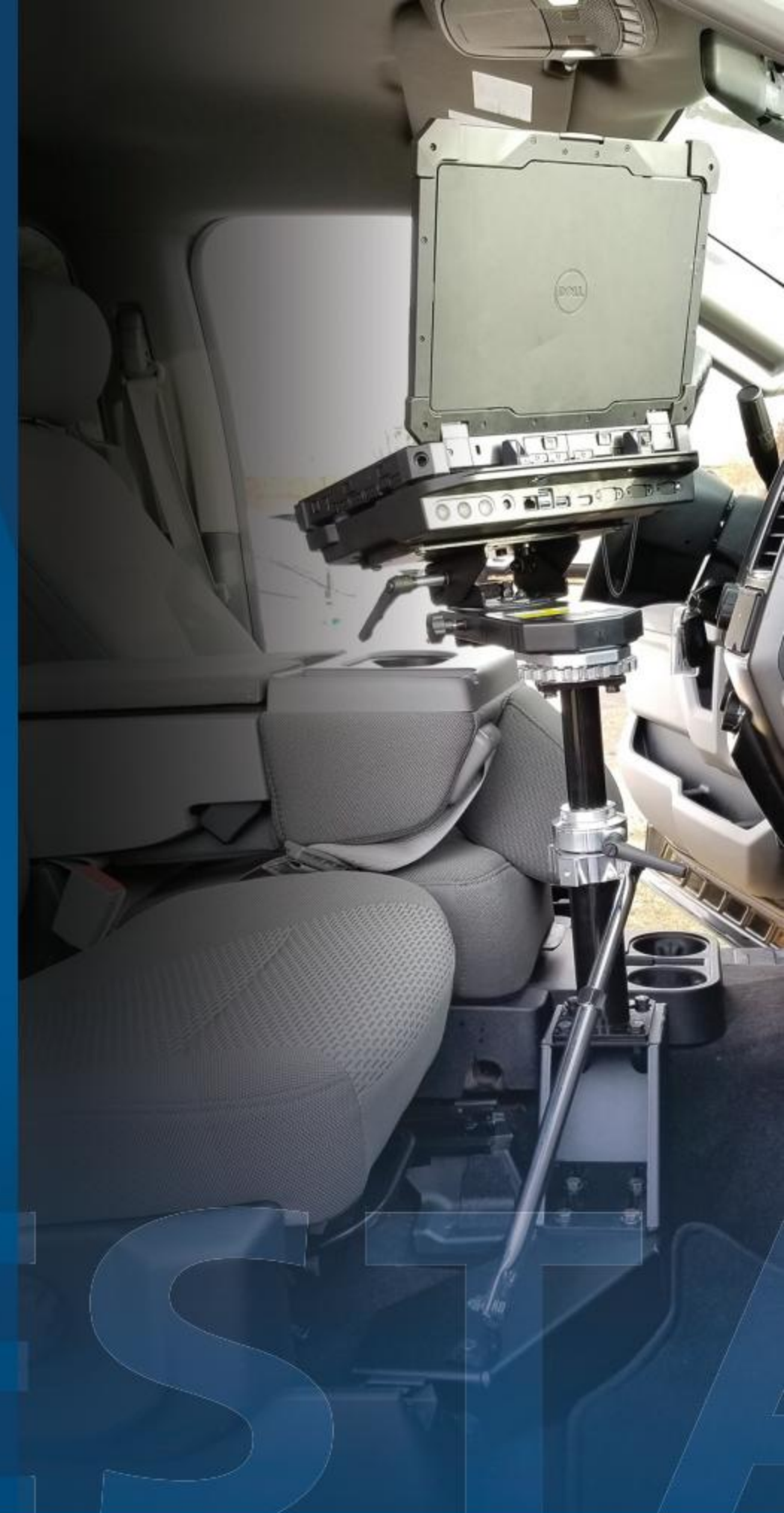

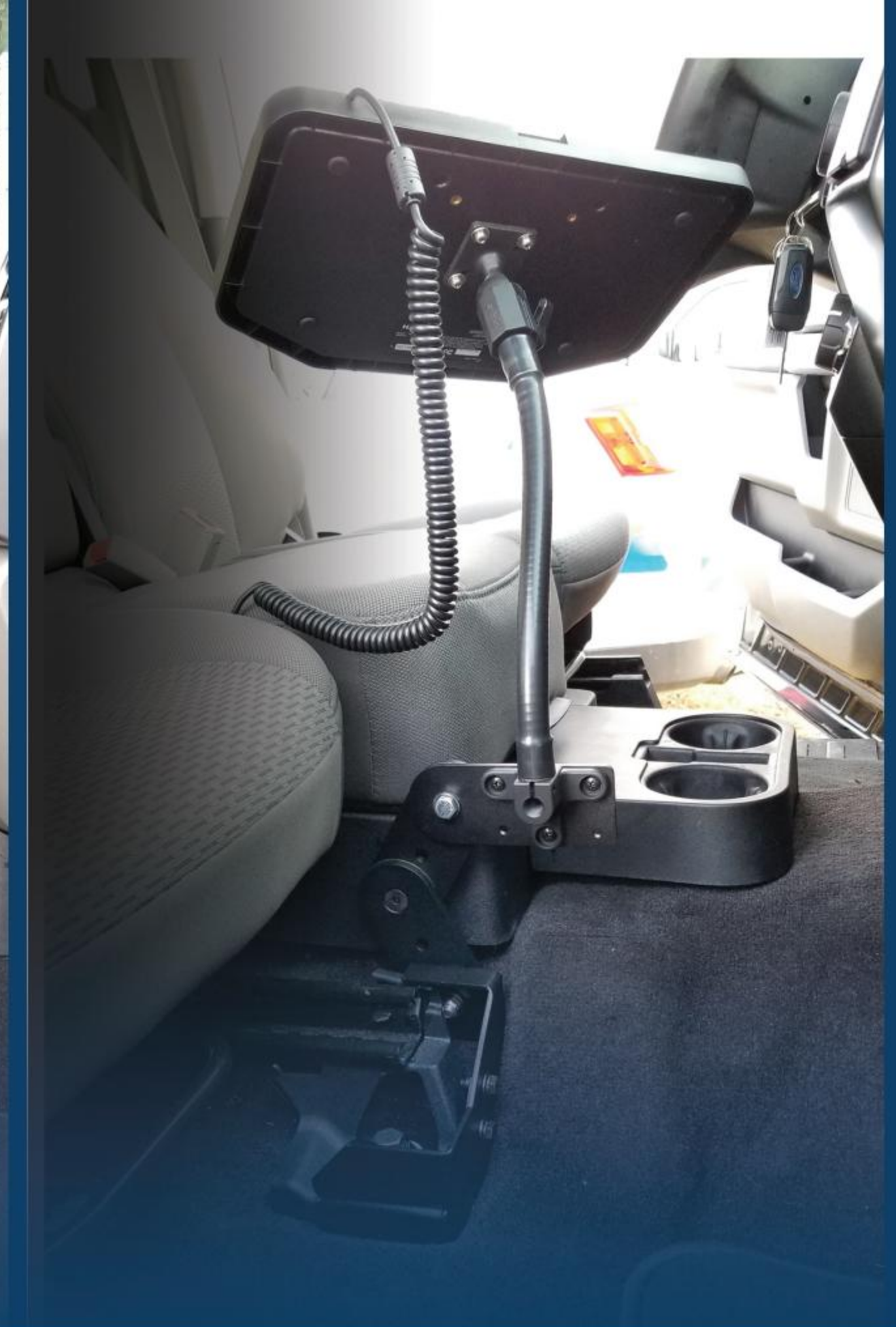



VEHICLE SPECIFIC SOLUTIONS FOR COMMERCIAL TRUCK & VAN

MAKE	START YEAR
FORD	
Transit Connect	2009
Transit Connect	2014
Transit	2015
F-150	2009
F-150	2015
F-250-550	2011
F-250-550	2017
E Series	1997
GM	
Colorado	2015
Silverado	2014
Silverado	2019
Sierra	2015
Sierra	2019
G-series/Savanna	1997
NISSAN	
Frontier	2011
RAM	
1500-5500	2013
Promaster	2015
MERCEDES BENZ	
Sprinter	2007
TOYOTA	
Tacoma	N/A
Tundra	2007
INTERNATIONAL	
4300/7300	2011
FREIGHTLINER	
M2	2004

END YEAR	DMM-2000	DMM-3000	PKG-PSM-100	PKG-PSM-300	PKG-FAM-100
2013	N/A	N/A	PKG-PSM-143	PKG-PSM-343	PKG-FAM-118
2019	N/A	N/A	PKG-PSM-189	PKG-PSM-389	PKG-FAM-115
2019	C-DMM-2005	C-DMM-3010	PKG-PSM-183	PKG-PSM-383	PKG-FAM-118
2014	C-DMM-2011	N/A	PKG-PSM-108	PKG-PSM-308	PKG-FAM-118
2019	C-DMM-2006	C-DMM-3006	PKG-PSM-185	PKG-PSM-385	PKG-FAM-114
2016	C-DMM-2007	C-DMM-3009	PKG-PSM-142	PKG-PSM-342	PKG-FAM-110
2019	C-DMM-2006	C-DMM-3006	PKG-PSM-185	PKG-PSM-385	PKG-FAM-114
2018	N/A	C-DMM-3009	PKG-PSM-140	PKG-PSM-340	PKG-FAM-118
2019	C-DMM-2008	N/A	PKG-PSM-188	PKG-PSM-388	PKG-FAM-118
2018	C-DMM-2010	N/A	PKG-PSM-176	PKG-PSM-376	PKG-FAM-113
2019	N/A	C-DMM-3007	PKG-PSM-1003	PKG-PSM-3003	PKG-FAM-118
2018	N/A	N/A	PKG-PSM-176	PKG-PSM-376	PKG-FAM-113
2019	N/A	C-DMM-3007	PKG-PSM-1003	PKG-PSM-3003	PKG-FAM-118
2019	N/A	N/A	PKG-PSM-139	PKG-PSM-339	PKG-FAM-118
2018	C-DMM-2012	N/A	PKG-PSM-193	PKG-PSM-393	PKG-FAM-117
2018			PKG-PSM-152	PKG-PSM-352	PKG-FAM-107
2015	N/A	N/A	PKG-PSM-181	PKG-PSM-381	PKG-FAM-118
2018	N/A	N/A	PKG-PSM-131	PKG-PSM-331	PKG-FAM-118
N/A	N/A	N/A	N/A	N/A	PKG-FAM-118
2018	N/A	N/A	PKG-PSM-130	PKG-PSM-330	PKG-FAM-118
2018	N/A	N/A	PKG-PSM-184	PKG-PSM-384	PKG-FAM-118
2018	N/A	N/A	PKG-PSM-186	PKG-PSM-386	PKG-FAM-118

KEYBOARD MOUNTING SOLUTIONS

USB KEYBOARD & TOP MOUNT

KB-101, C-MAG-100

- Ultra-thin design
- Fully sealed IP65 case
- Integrated touch pad
- Silicone rubber
- Red backlit keys
- USB connectivity

BLUETOOTH KEYBOARD & MAGNETIC MOUNT

KB-103, C-MAG-100

- Ultra-thin design
- Fully sealed IP65 case
- Integrated touch pad
- Silicone rubber
- Red backlit keys
- USB connectivity



USB KEYBOARD & SIDE MOUNT

PKG-KB-201, CM006331,
C-MD-204

- Ultra-thin design
- Integrated touch pad
- Silicone rubber keypad
- Red backlit keys
- USB & Bluetooth connectivity

DUAL AUTHENTICATION & SIDE MOUNT

KB-104; C-KBM-201; CM006331; C-MD-204

- Integrated fingerprint reader
- USB & mounting pins for additional device
- Integrated touch pad
- Silicone rubber keypad
- Red backlit keys





VERSATILE SOLUTIONS



UNIVERSAL CRADLE & MOUNT

UT-301, C-MAG-100

- Universal Cradle for 7" to 9" devices
- Portrait or landscape viewing
- Lock & key Included
- 140 lb pull Magnetic Mount

RUGGED PHONE MOUNT

PKG-WIN-102; PKG-WIN-101

- Industrial suction cup mounting
- Fully adjustable
- Quick release button
- Standard & telescoping 18" arm





VERSATILE SOLUTIONS

HAVIS



VERSATILE SOLUTIONS

HAVIS REDEFINES COMFORT WITH VERSATILE SOLUTIONS.

Just because technology changes, doesn't mean your mount should change.

Versatile Solutions offer the strong hold and durability you expect from Havis, without the commitment to one device.

Adaptable. Dependable. Adjustable.



KEEPING YOUR DEVICE WITHIN ARMS REACH

Phones are an integral part of our daily life. Choose a strong mount with adjustable arm & universal cradle that adapts to the way you live.

- Suction Cup Phone Cradle: PKG-WIN-101
- Suction Cup Phone Cradle Long: PKG-WIN-102
- Phone Cradle: UT-501

ACCESSIBLE

VERSATILE SOLUTIONS

DEPENDABLE & CONVENIENT



SECURE MOUNTS FOR THE WORK PLACE

Phones, tablets, scanners and printers are essential tools. Keep them safe and convenient throughout the work place with material handling solutions.

- Bar Clamp Mount: MD-403
- Dual Ball Bolt Mount: MD-401
- Dual Ball Bolt Mount MD-402



STURDY & CON

ADAPTABLE & UNIVERSAL

Technology should be accessible. Our mounts adapt to the work place and adjust to your needs, without taking up space.

- Magnet Mount: MAG-100
- Bluetooth Keyboard: KB-103
- 7-9" Tablet Cradle: UT-301



EFFICIENT & FLEXIBLE

FLEXIBILITY WHERE YOU NEED IT

Working from your vehicle ought to be easy. The Flexible Arm mount gives you access to technology when you need it, where you need it.



VEHICLE	DATES	SKU
FORD INTERCEPTOR UTILITY	2013-2019	PKG-FAM-104
FORD F-SERIES	2015-2019	PKG-FAM-114
FORD TRANSIT	2013-2019	PKG-FAM-115
FORD FUSION	2013-2019	PKG-FAM-108
CHEVY TAHOE	2015-2019	PKG-FAM-113
CHEVY SILVERADO	2015-2018	PKG-FAM-113
GMC YUKON	2015-2019	PKG-FAM-113
CHEVY SUBURBAN	2015-2019	PKG-FAM-113
DODGE CHARGER	2011-2019	PKG-FAM-111
DODGE RAM	2013-2019	PKG-FAM-107
UNIVERSAL		PKG-FAM-118



PUBLIC SAFETY MOBILE SOLUTIONS



DELIVERING
HIGH-QUALITY
PRODUCTS TO
MAXIMIZE
MOBILE WORKER
PRODUCTIVITY



HAVIS BUNDLING IS THE SMART SOLUTION

EXPERIENCE OUR CONSULTATIVE APPROACH



Vehicle Specific Consoles



Touch Screen Display



Laptop & Tablet Docking



Rugged Keyboard & Integrated Mount

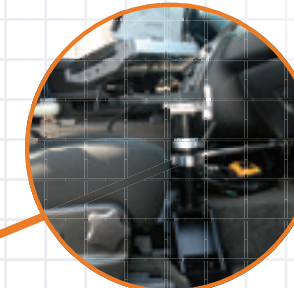

Unique Motion Devices



Innovative Accessories

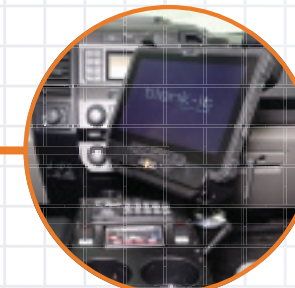

Screen Blanking



Universal Cradles



K9 Transport



Integrated Control System



Prisoner Transport

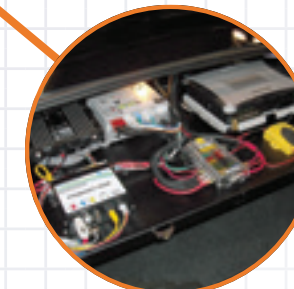

Trunk Mounting



TOTAL MOBILITY SOLUTION

Havis is a Key Component to Your Total Mobility Solution.
Your Total Mobility Solution starts with a business problem and includes:



- **Software** to solve the business problem for the end user
- **Hardware** to run the software inside the vehicle
- **Connectivity & Integration** to the back-end systems
- **Havis Docking & Mounting** solutions to make sure the hardware is mounted safely and allows for greatest up-time and productivity
- **Screen Blanking** solutions powered by Blank-It to manage in-vehicle computer displays and prevent driver distraction
- **Power Management** solutions to ensure sufficient output of the computing device for extended periods of time
- **Accessories** such as keyboards to assist in completing your Total Mobility Solution

Industry Partnerships



Getac

Panasonic

FUJITSU



Microsoft



DODGE



FREIGHTLINER

Jeep





WORK TRUCK AND VAN COMPUTING SOLUTIONS



DELIVERING
HIGH-QUALITY
PRODUCTS TO
MAXIMIZE
MOBILE WORKER
PRODUCTIVITY



HAVIS BUNDLING IS THE SMART SOLUTION

EXPERIENCE OUR CONSULTATIVE APPROACH



Touch Screen Display



Laptop & Tablet Docking



Universal Cradles



Screen Blanking



Vehicle Specific Consoles



Unique Motion Devices

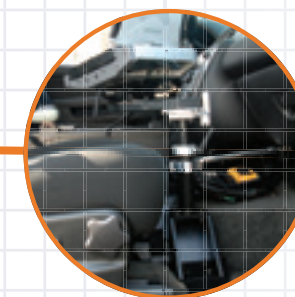

IdleRight



Trunk Mounting

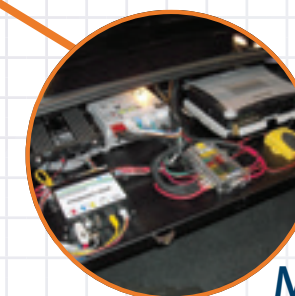

Chargeguard



Power Supplies



Rugged Keyboard & Integrated Mount



TOTAL MOBILITY SOLUTION

Havis is a Key Component to Your Total Mobility Solution.
Your Total Mobility Solution starts with a business problem and includes:



- **Software** to solve the business problem for the end user
- **Hardware** to run the software inside the vehicle
- **Connectivity & Integration** to the back-end systems
- **Havis Docking & Mounting** solutions to make sure the hardware is mounted safely and allows for greatest up-time and productivity
- **Screen Blanking** solutions powered by Blank-It to manage in-vehicle computer displays and prevent driver distraction
- **Power Management** solutions to ensure sufficient output of the computing device for extended periods of time
- **Accessories** such as keyboards to assist in completing your Total Mobility Solution

Industry Partnerships



Getac

Panasonic

FUJITSU



Microsoft



DODGE



FREIGHTLINER

Jeep





MATERIAL HANDLING COMPUTING SOLUTIONS



DELIVERING
HIGH-QUALITY
PRODUCTS TO
MAXIMIZE
MOBILE WORKER
PRODUCTIVITY



HAVIS BUNDLING IS THE SMART SOLUTION

EXPERIENCE OUR CONSULTATIVE APPROACH



Rugged Keyboards & Mounts



Forklift Mounts

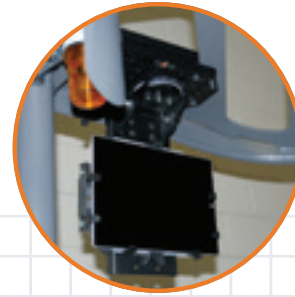

Laptop & Tablet Docking Stations



Universal Cradles



Touch Screen Display

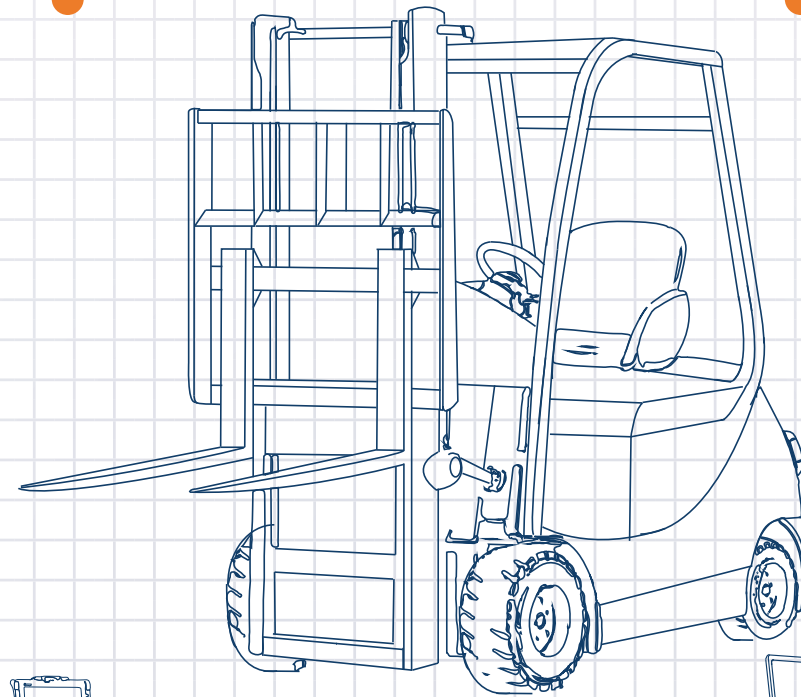

Pallet Jack Mounts

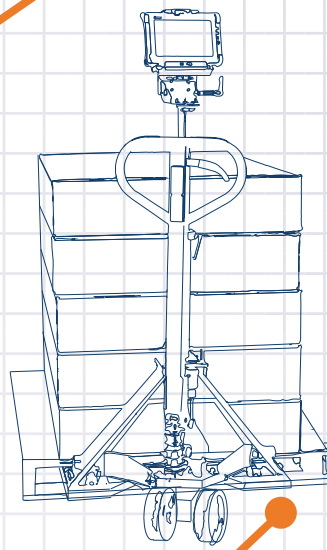

Work Cart Mounts



Isolated Power Supplies



Weatherproof Docking Solutions



Screen Blanking



TOTAL MOBILITY SOLUTION

Havis is a Key Component to Your Total Mobility Solution.
Your Total Mobility Solution starts with a business problem and includes:



- **Software** to solve the business problem for the end user
- **Hardware** to run the software inside the vehicle
- **Connectivity & Integration** to the back-end systems
- **Havis Docking & Mounting** solutions to make sure the hardware is mounted safely and allows for greatest up-time and productivity
- **Screen Blanking** solutions powered by Blank-It to manage in-vehicle computer displays and prevent driver distraction
- **Power Management** solutions to ensure sufficient output of the computing device for extended periods of time
- **Accessories** such as keyboards to assist in completing your Total Mobility Solution

Industry Partnerships



Getac

Panasonic

FUJITSU



Microsoft



DODGE



Jeep





INTEGRATED CONTROL SYSTEM



In cooperation with:



PROGRESSIVE IN-VEHICLE TECHNOLOGY FOR THE MODERN POLICE FLEET



Ford Police Interceptor Utility



Ford Police Interceptor Sedan

AN ENHANCED USER EXPERIENCE EMERGES

The Integrated Control System combines cutting-edge, on-board technology, the convenience of touch control, and increased space to provide police officers with a comfortable, safe and connected solution in their cockpit. This highly integrated and customizable control system also creates a more efficient work environment.

- **Vehicle Integration:** The Integrated Control System is designed to fit the Ford Police Interceptor Utility and Ford Police Interceptor Sedan dash without permanent modification. Retrofit can restore original OEM dash or leave the display.
- **Safety:** By relocating computers and video sources to the trunk, the Integrated Control System allows for a flush profile of the OEM dash and a clean cockpit. This ensures OEM safety systems are unobstructed and avoids airbag interference.
- **Ergonomics:** The placement and orientation of the Touch Screen Display achieve the ideal position for the driver's and passenger's health, comfort, efficiency and safety.
- **Display Visibility and Durability:** The ultra-wide viewing angle of the sunlight-readable LCD Touch Screen Display gives the driver or passenger full control of the system. It is composed of chemically strengthened glass that can withstand impact without chipping.



HOW THE HAVIS INTEGRATED CONTROL SYSTEM WORKS



VIDEO DISPLAY 1

Driven by the Embedded Processor, the Touch Screen Display provides control for functions such as AM/FM Radio, camera, systems, and settings.

The **Touch Screen Display** provides user control of all functions and settings in the Integrated Control System.

Use one-touch **MODE** button to easily alternate between Video Display 1 and 2.



VIDEO DISPLAY 2

The A/V Extender allows for video input from a remote PC, Laptop or Tablet that connects to the Touch Screen Display.

The **Embedded Processor** connects to Ford wiring and replaces the OEM AM/FM Radio Module.



A sophisticated audio management system prioritizes the use of the vehicle's audio system so important communications are not missed.

Vehicle Cabin

Vehicle Trunk



Havis trunk mounts secure and organize the PC, laptop or tablet as well as other in-vehicle equipment. Havis also recommends installing ChargeGuard to prevent dead batteries.



In the closed position, Havis' recommended trunk mounts protect equipment and provide access to the majority of the trunk space for additional storage and transport.

BASE PACKAGE COMPONENTS

Touch Screen Display



- 12.1" ultra-durable portrait display
- Multi-touch operation (pinch & swipe)
- Pressure sensitive screen allows for use with wet gloves and/or gloves
- Power and video from a single cable from Embedded Processor
- Internal heater activates below -20°C

Resolution	800 x 1280 (optimal), 1024 x 1280, & 1024 x 1600
Brightness	1200 NIT Daylight Readable
Viewing Angle	88° from all angles
Environmental	-20°C to +70°C (-4°F to +158°F)

Tactile Controls



- Convenient tactile control of Touch Screen
- Display: volume, display brightness and blackout
- One-touch MODE button easily alternates between the two displays
- Replaces factory HVAC (climate) controls, hazards and airbag indication
- Compatible with OEM factory wiring
- HVAC Fan speed, Temperature and Volume are displayed on Touch Screen Display when changed
- An audible beep can be heard on the system speakers to indicate a valid HVAC button press

Touch Technology	Cap-Sense touch pad controls
Buttons	16 controls with LED back-lighting and status indication
Environmental	-40°C to + 85°C (-40°C to +185°C)

A/V Extender



- Ability to remotely connect an external audio/video source to the Touch Screen Display such as PC, laptop or tablet
- Connects VGA or HDMI, micro-USB*, and analog audio to Embedded Processor with a single shielded CAT6A cable, which is designed for an automotive environment

Inputs from PC	VGA, HDMI, micro-USB*, Audio
Power	No separate power required
Environmental	-40°C to + 85°C (-40°C to +185°C)

* micro-USB only allows for the input of external keyboard, mouse and touch screen feedback

Embedded Processor



- Mounts in place of OEM AM/FM radio module
- Controls AM/FM Radio, A/V Extender
- Steering wheel control functionality is highly customizable to provide "one push" operation of critical functions
- Supports Bluetooth Phone connectivity via the Parrot CK3100 Car System

I/O	CAN, USB, RS232, Ethernet, Discrete, A/V
Amplifier	4 x 20W speakers
Radio	AM/FM/WB tuner
Application Framework	Android 4.1
Environmental	-40°C to +85°C (-40°C to +185°C)

RECOMMENDED MOUNTING OPTIONS

Console Mounting Packages	Vehicle specific console (standard or low profile), cup holders and arm rest
Console Mounting and Keyboard Packages	Vehicle specific console (standard or low profile), cup holders, arm rest, keyboard with mounting plate, and tilt-swivel motion device
Trunk Mounting	FORD POLICE INTERCEPTOR SEDAN: Premium Fold Down Trunk Tray or Full Width Trunk Tray Bearing FORD POLICE INTERCEPTOR UTILITY: Universal Storage Box for Utility Vehicles or Premium Fold Up Equipment Tray

Universal Products

Havis Touch Screen Display & Havis Keyboard and Mount (patent pending) System

Touch Screen Display: Maximizes in-vehicle cabin area for driver and passenger, as it is mounted to dash and computing device and docking station are mounted in trunk. Capacitive technology allows multi-touch 2 finger for pinch, zoom, activate.

Keyboard and Mount (patent pending) System: Havis Rugged USB Backlit Keyboard and Mount are an impressive combination. IP65 rating, red monochrome illumination and capacitive technology allows multi-touch 2 finger mousepad.



Laptop and Tablet Docking Stations/Cradles

Havis' docking stations are available for Panasonic, Dell, Getac and more. The Universal Laptop and Tablet Mount allows you to mount any brand of laptop computer or tablet without sacrificing crash test standards and durability.

Mobile Office Accessories

For in-vehicle mobile equipment, Havis offers innovative accessories such as the Rugged Hub - a USB/Ethernet Communications Hub. This groundbreaking product makes adding peripherals to your mobile workspace safe, and easy. Other mounting accessories such as printer mounts and card reader brackets allow you to effectively run customer information & print receipts directly from your vehicle.



Power Management Solutions

Auto Shut-Off Timer: ChargeGuard® auto shut-off timers safeguard expensive communications devices and computers with intelligent circuitry protection, ultimately ensuring you will never have a dead battery again.

Idle Management: IdleRight2® is the next generation of Havis Idle Reduction systems, saving you fuel and maintenance costs by reducing idle time while performing mission-critical tasks in your mobile workspace.

Havis can support many vehicles with our quality products that are designed specifically for that vehicle type. Combine those with the hundreds of universally mounted products Havis manufactures, and you have the largest product portfolio available. You can create your mobile office the way you want and the way you need it.

All of Havis' products are designed to seamlessly work with each other to complete your solution. Contact a Havis representative to assist in configuring our products into a "build your own solution" that meets all of your needs.

HAVIS

Vehicle Solutions

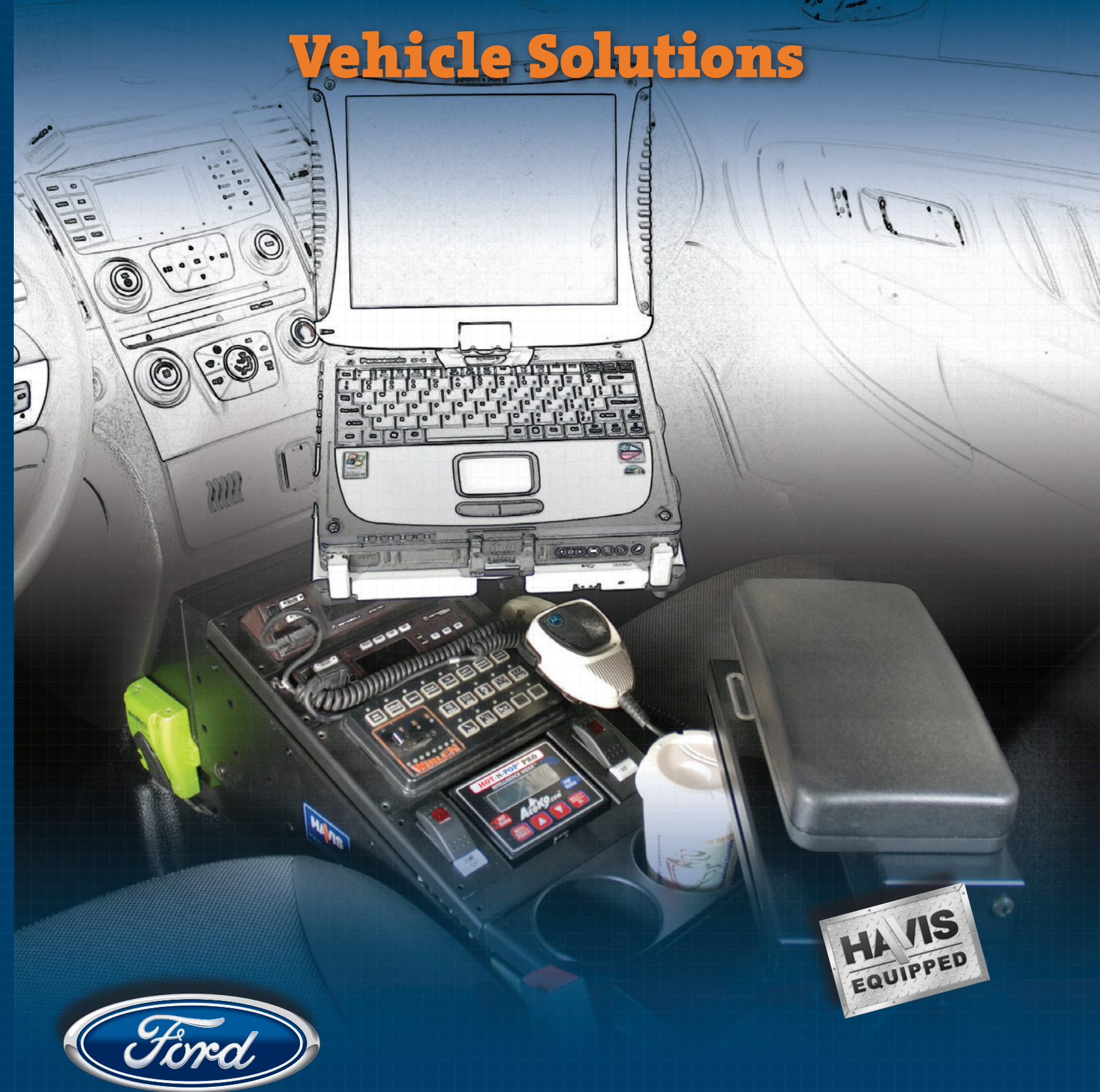

Ford Vehicle Solutions



Interceptor Utility

Vehicle Specific Consoles

Our Vehicle Specific Consoles are designed to make installation easier by utilizing existing bolt locations, which removes the need to drill holes.



Interceptor Sedan



Explorer



E-xpedition



F250 Pickup



Interceptor Sedan

Trunk Mounted Storage

With the right trunk mount, you can optimize storage space and provide a clean, safe, and secure mounting surface for expensive radio and communications equipment.



Interceptor Utility



Interceptor Sedan



Interceptor Utility



Fusion Sedan

Heavy Duty Mounting Systems

Havis passenger side mounts are rugged, professional grade computer mounts that combine the perfect balance of strength, safety, and ultrasmooth operation.



F250 Pickup



Focus Sedan



Expedition SUV



E-Series Van



Interceptor Utility

K9 Transportation Units

Havis K9 units feature rounded corners and a heavy-duty white powder coat finish, which allows for improved canine entry and exit, as well as easy access for cleaning.

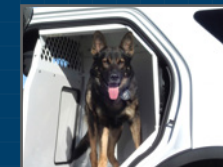

Interceptor utility



Interceptor Sedan



Expedition



Explorer



F150 Crew Cab Special Service



Interceptor Utility

Dash Monitor Mounts

The Havis Monitor Mount System utilizes interchangeable parts to mount your monitor and keyboard to any vehicle, without permanent modification.



Interceptor Sedan



Interceptor Utility



F250 Pickup



E Series Van



Transit

Prisoner Transport Units

Offered in three different lengths, the units allow you to transport a combination of six to twelve people in one to three compartments and still offers room for storage.



Different Lengths



Side Compartments



E-Series Van

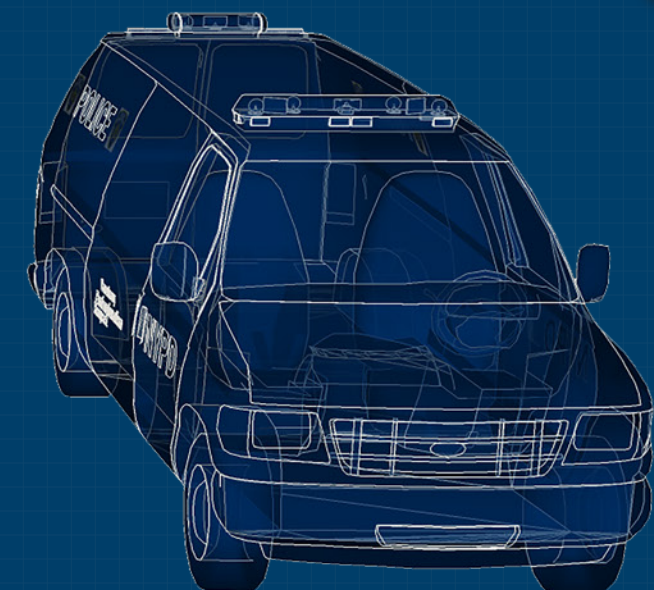
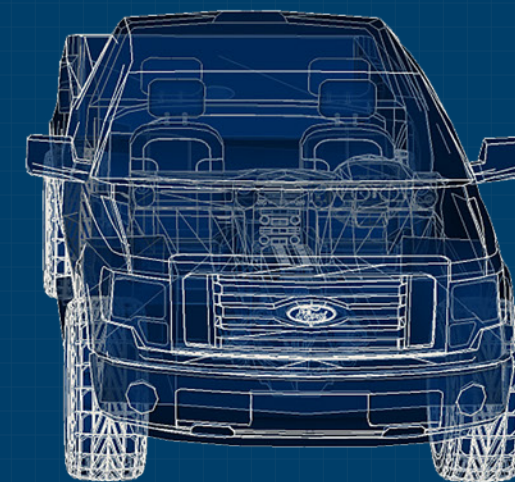
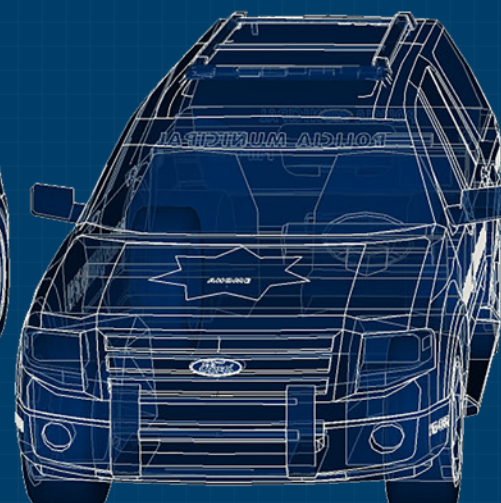
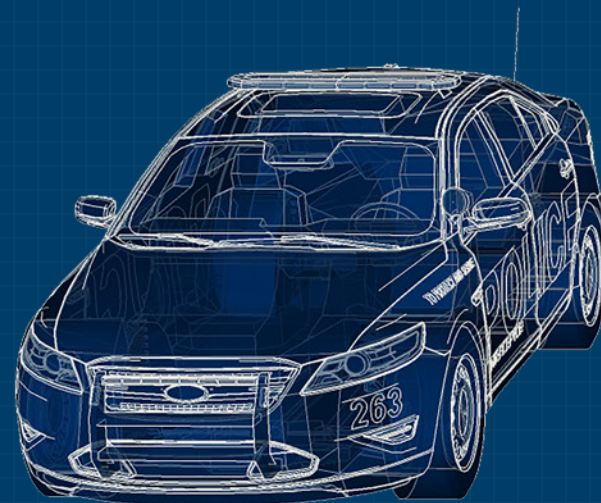

Universal Products

Havis Touch Screen Display & Havis Keyboard and Mount (patent pending) System

Touch Screen Display: Maximizes in-vehicle cabin area for driver and passenger, as it is mounted to dash and computing device and docking station are mounted in trunk. Capacitive technology allows multi-touch 2 finger for pinch, zoom, activate.

Keyboard and Mount (patent pending) System: Havis Rugged USB Backlit Keyboard and Mount are an impressive combination. IP65 rating, red monochrome illumination and capacitive technology allows multi-touch 2 finger mousepad.

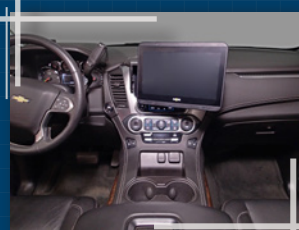

Laptop and Tablet Docking Stations/Cradles

Havis' docking stations are available for Panasonic, Dell, Getac and more. The Universal Laptop and Tablet Mount allows you to mount any brand of laptop computer or tablet without sacrificing crash test standards and durability.

Mobile Office Accessories

For in-vehicle mobile equipment, Havis offers innovative accessories such as the Rugged Hub - a USB/Ethernet Communications Hub. This groundbreaking product makes adding peripherals to your mobile workspace safe, and easy. Other mounting accessories such as printer mounts and card reader brackets allow you to effectively run customer information & print receipts directly from your vehicle.



Power Management Solutions

Auto Shut-Off Timer: ChargeGuard® auto shut-off timers safeguard expensive communications devices and computers with intelligent circuitry protection, ultimately ensuring you will never have a dead battery again.

Idle Management: IdleRight2® is the next generation of Havis Idle Reduction systems, saving you fuel and maintenance costs by reducing idle time while performing mission-critical tasks in your mobile workspace.

Havis can support many vehicles with our quality products that are designed specifically for that vehicle type. Combine those with the hundreds of universally mounted products Havis manufactures, and you have the largest product portfolio available. You can create your mobile office the way you want and the way you need it.

All of Havis' products are designed to seamlessly work with each other to complete your solution. Contact a Havis representative to assist in configuring our products into a "build your own solution" that meets all of your needs.

HAVIS

Vehicle Solutions



CHEVROLET



Chevrolet Vehicle Solutions



Tahoe PPV

Vehicle Specific Consoles

Our Vehicle Specific Consoles are designed to make installation easier by utilizing existing bolt locations, which removes the need to drill holes.



Impala

Caprice

Express G-Series Van

GMC Yukon

Heavy Duty Mounting Systems

Havis passenger side mounts are rugged, professional grade computer mounts that combine the perfect balance of strength, safety, and ultrasmooth operation.



Colorado/Canyon

Caprice

Express G-Series Van

Impala



Chevrolet Tahoe/GMC Yukon



Tahoe PPV

Dash Monitor Mounts

The Havis Monitor Mount System utilizes interchangeable parts to mount your monitor and keyboard to any vehicle, without permanent modification.



Caprice

Express G-Series Van

Impala

Caprice



Tahoe (Storage Box)

Trunk Mounted Storage

With the right trunk mount, you can optimize storage space and provide a clean, safe, and secure mounting surface for expensive radio and communications equipment.



Impala (Slide-out)

Impala (Side fold-down)

Caprice (Fold-down)

Universal Storage Box

K9 Transportation Units

Havis K9 units feature rounded corners and a heavy-duty white powder coat finish, which allows for improved canine entry and exit, as well as easy access for cleaning.



Impala

Tahoe (32" Length)

Suburban (K9/PT Unit)

Caprice



Tahoe/GMC Yukon

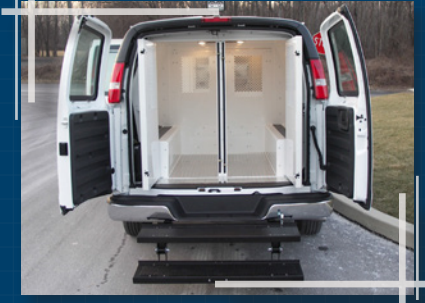

Express Van

Prisoner Transport Units

Offered in three different lengths, the units allow you to transport a combination of six to twelve people in one to three compartments and still offers room for storage.



Different Lengths

Side Compartments

Vehicle Specific Console

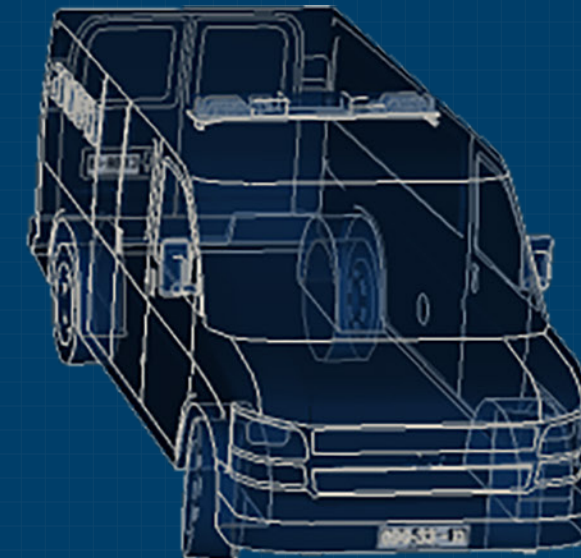
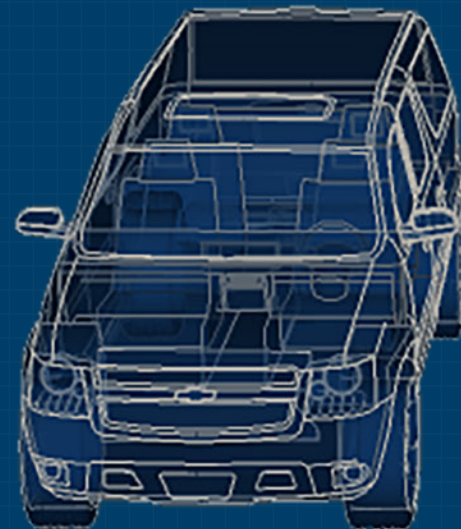

Universal Products

Havis Touch Screen Display & Havis Keyboard and Mount *(patent pending) System*

Touch Screen Display: Maximizes in-vehicle cabin area for driver and passenger, as it is mounted to dash and computing device and docking station are mounted in trunk. Capacitive technology allows multi-touch 2 finger for pinch, zoom, activate.

Keyboard and Mount *(patent pending) System:* Havis Rugged USB Backlit Keyboard and Mount are an impressive combination. IP65 rating, red monochrome illumination and capacitive technology allows multi-touch 2 finger mousepad.



Laptop and Tablet Docking Stations/Cradles

Havis' docking stations are available for Panasonic, Dell, Getac and more. The Universal Laptop and Tablet Mount allows you to mount any brand of laptop computer or tablet without sacrificing crash test standards and durability.

Mobile Office Accessories

For in-vehicle mobile equipment, Havis offers innovative accessories such as the Rugged Hub - a USB/Ethernet Communications Hub. This groundbreaking product makes adding peripherals to your mobile workspace safe, and easy. Other mounting accessories such as printer mounts and card reader brackets allow you to effectively run customer information & print receipts directly from your vehicle.



Power Management Solutions

Auto Shut-Off Timer: ChargeGuard® auto shut-off timers safeguard expensive communications devices and computers with intelligent circuitry protection, ultimately ensuring you will never have a dead battery again.

Idle Management: IdleRight2® is the next generation of Havis Idle Reduction systems, saving you fuel and maintenance costs by reducing idle time while performing mission-critical tasks in your mobile workspace.

Havis can support many vehicles with our quality products that are designed specifically for that vehicle type. Combine those with the hundreds of universally mounted products Havis manufactures, and you have the largest product portfolio available. You can create your mobile office the way *you* want and the way *you* need it.

All of Havis' products are designed to seamlessly work with each other to complete your solution. Contact a Havis representative to assist in configuring our products into a "build your own solution" that meets all of your needs.

HAVIS

Vehicle Solutions

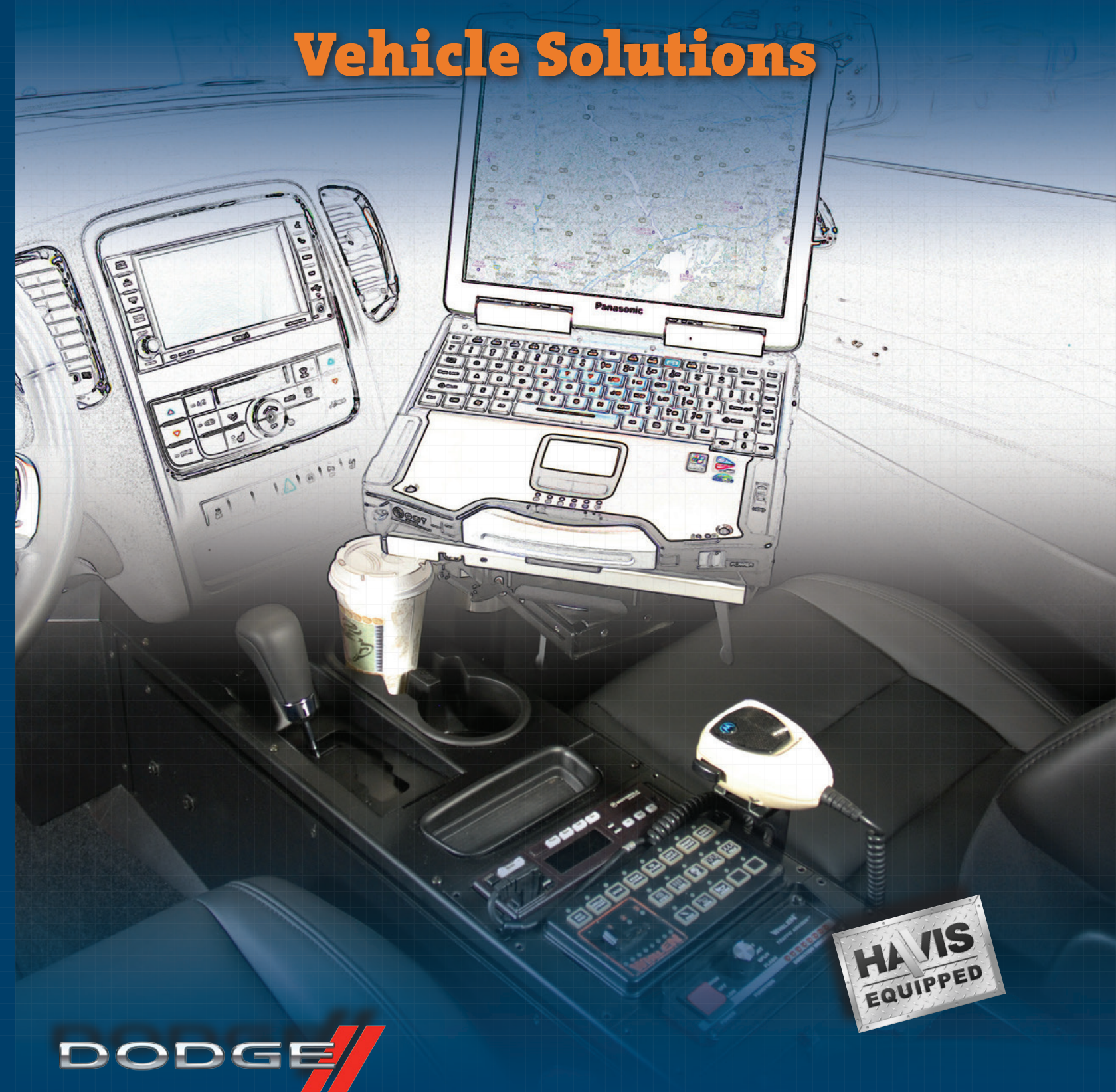

Dodge Vehicle Solutions



Charger (25")

Vehicle Specific Consoles

Our Vehicle Specific Consoles are designed to make installation easier by utilizing existing bolt locations, which removes the need to drill holes.



Durango

Charger (24")

Ram Pick-up

Charger (17")

Heavy Duty Mounting Systems

Havis passenger side mounts are rugged, professional grade computer mounts that combine the perfect balance of strength, safety, and ultrasmooth operation.



Ram Pick Up

Charger

Caravan

Dakota Pick-up



Ram Pick-up



Charger

Dash Monitor Mounts

The Havis Monitor Mount System utilizes interchangeable parts to mount your monitor and keyboard to any vehicle, without permanent modification.

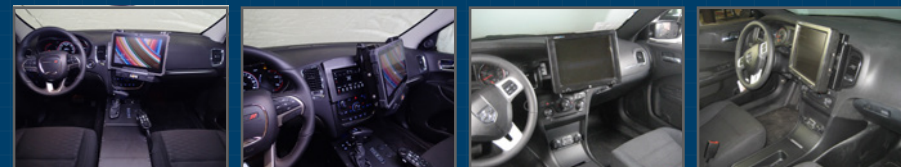

Durango

Charger



Charger (slide-out)

Trunk Mounted Storage

With the right trunk mount, you can optimize storage space and provide a clean, safe, and secure mounting surface for expensive radio and communications equipment.



Trunk Side Mount (Driver Side)

Trunk Side Mount (Passenger Side)

Fold Down Trunk Tray

Universal Storage Box (Mounts to any flat surface)

K9 Transportation Units

Havis K9 units feature rounded corners and a heavy-duty white powder coat finish, which allows for improved canine entry and exit, as well as easy access for cleaning.



Durango

Charger

Optional Window Fan

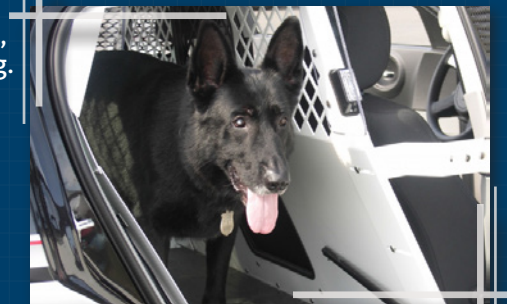

Charger



ProMaster

Prisoner Transport Units

Offered in three different lengths, the units allow you to transport a combination of six to twelve people in one to three compartments and still offers room for storage.



Different Lengths

Side Compartments

Fold Down Steps

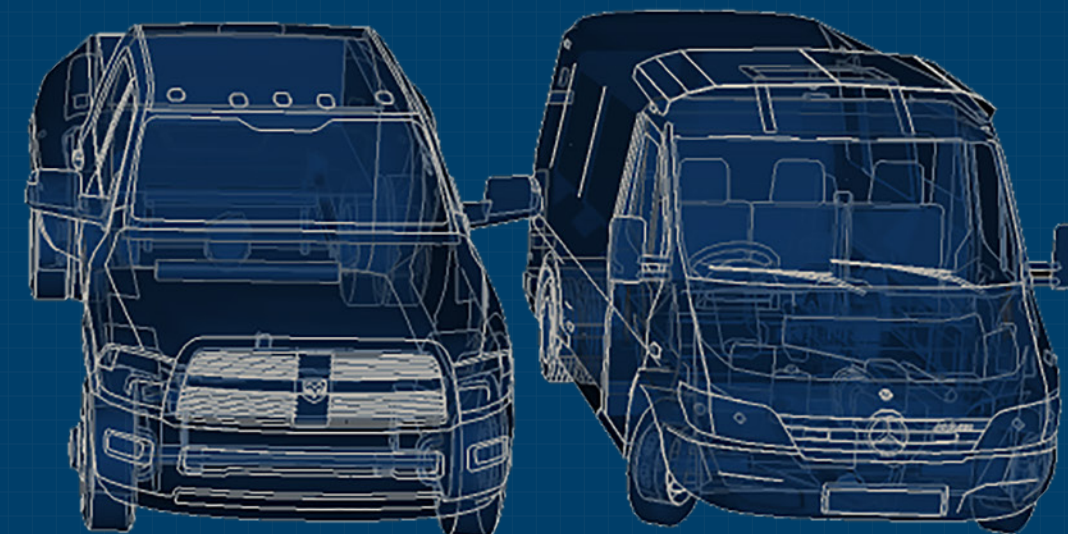
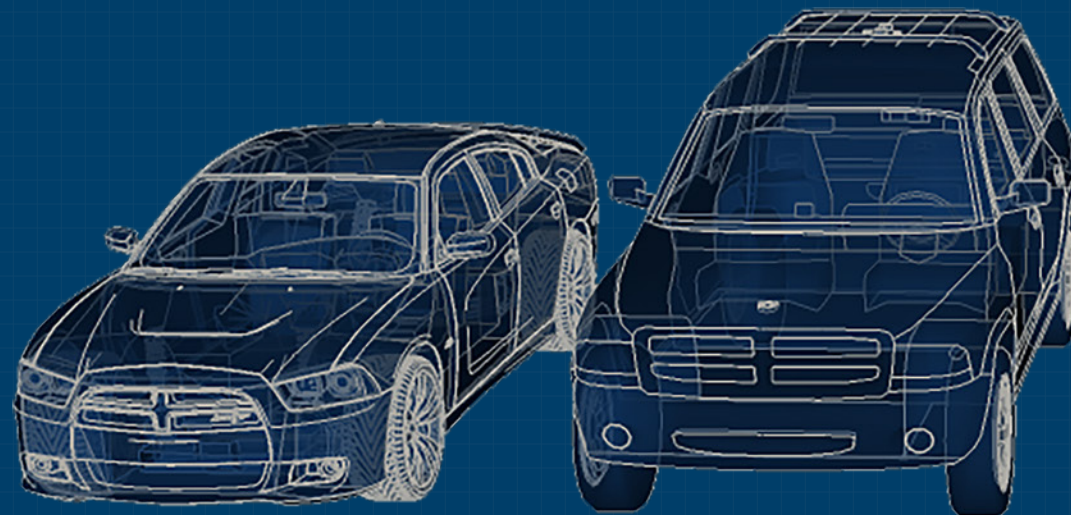

Related Havis Products for Panasonic Computing Solutions

Part Number	Part Description	Docking Station Compatibility
EP5-PAN-XXX	Extended Protection Plan 5 year enhanced protection plan for Havis Toughbook Certified docking stations	• All Docking Stations
DS-DA-801	Havis Screen Blanking Solution powered by Blank-it Manage in-vehicle computer displays and prevent driver distraction.	• All Docking Stations
DS-DA-804	Havis Screen Blanking Solution with Tamperproof Cover Manage in-vehicle computer displays and prevent driver distraction.	• DS-PAN-700 Series
DS-DA-805	Havis Screen Blanking Solution with Tamperproof Cover Manage in-vehicle computer displays and prevent driver distraction.	• DS-PAN-900 Series
DS-DA-602	Rugged Communications Hub Rugged USB/Ethernet hub makes adding peripherals to your mobile workspace easy and safe.	• All Docking Stations
DS-DA-503	Replacement Keys	• DS-PAN-300 Series • DS-PAN-500 Series
DS-DA-502	Replacement Keys	• DS-PAN-410 Series
DS-DA-501	Replacement Keys	• DS-PAN-110 Series • DS-PAN-600 Series • DS-PAN-210 Series • DS-PAN-700 Series • DS-PAN-220 Series • DS-PAN-900 Series
DS-DA-417	Screen Stiffener	• DS-PAN-420 Series
DS-DA-410	Screen Stiffener	• DS-PAN-410 Series
DS-DA-409	Screen Stiffener	• DS-PAN-110 Series
DS-DA-405	Screen Stiffener	• DS-PAN-210 Series • DS-PAN-220 Series
DS-DA-311	Side Exiting USB Cable Allows for more convenient access for up to two USB 2.0 ports. Can be mounted on the right or left side.	• DS-PAN-600 Series
DS-DA-226	Card Reader Mounting Bracket Mount a E-Seek Model 250 card reader to the Docking Station.	• DS-PAN-420 Series
DS-DA-223	Card Reader Mounting Bracket Mount a Magtek card reader to the Docking Station.	• DS-PAN-110 Series • DS-PAN-210/220 Series • DS-PAN-300 Series
DS-DA-219	Rigid Mount Bracket Mounting kit for environments where tilt/swivel function is not necessary.	• DS-PAN-500 Series
DS-DA-218	Desktop Stand for Tablet Docking Stations Durable stand for mounting tablet Docking Stations for use in the home or office.	• DS-PAN-210/220 Series • DS-PAN-700 Series • DS-PAN-500 Series • DS-PAN-900 Series • DS-PAN-600 Series
DS-DA-214	Side Cover Brackets Strong steel and tamper-proof screws provide additional security to prevent hard drive theft.	• DS-PAN-210 Series • DS-PAN-220 Series
DS-DA-210	Cable Cover Brackets Protect cable connections at rear of Docking Station.	• DS-PAN-210 Series • DS-PAN-220 Series
DS-DA-207 DS-DA-213	Card Reader Mounting Bracket Mount an E-Seek Model 250 card reader to the side of the Docking Station. (Bracket can be customized for other card reader models)	• DS-PAN-110 Series (DS-DA-207) • DS-PAN-210 Series (DS-DA-213) • DS-PAN-220 Series (DS-DA-213)
DS-DA-102	USB Powered Keyboard Light Soft red LED light illuminates the laptop keyboard for night viewing.	• All Screen Stiffeners • DS-PAN-700 Series

LPS-101	90W External power supply and cable with cigarette lighter adaptor.	• DS-PAN-210 Series • DS-PAN-220 Series
LPS-102	90W External power supply and cable with cigarette lighter adaptor.	• DS-PAN-300 Series • DS-PAN-900 Series • DS-PAN-600 Series
LPS-104	120W External power supply and cable with cigarette lighter adaptor.	• DS-PAN-110 Series
LPS-106	120W External power supply and cable with cigarette lighter adaptor.	• DS-PAN-500 Series
LPS-112	120W External power supply and cable with cigarette lighter adaptor.	• DS-PAN-410 Series • DS-PAN-420 Series (LPS-204 Bracket available for mounting)
LPS-114	90W External power supply and cable with cigarette lighter adaptor.	• DS-PAN-700 Series



Havis Docking Solutions

Panasonic

TOUGHBOOK

DS-PAN-900 SERIES
Toughpad FZ-M1

DS-PAN-900 SERIES
Toughpad FZ-B2

DS-PAN-600 SERIES
Toughbook H2

DS-PAN-700 SERIES
Toughpad FZ-G1

DS-PAN-410 SERIES
Toughbook CF-53

DS-PAN-420 SERIES
Toughbook CF-54

DS-PAN-110 SERIES
Toughbook CF-30 & Toughbook CF-31

DS-PAN-220 SERIES
Toughbook CF-19



Havis Rugged Docking Stations

for Panasonic Toughbook Computers



DS-PAN-110 Series for Panasonic CF-30 & CF-31

Part Number	USB 2.0	Serial	Integrated Power	Ethernet	VGA	Speaker/Mic	Antenna Connection
DS-PAN-111	5	2	No	2	1	Yes	None DS-PAN-111-1 (Single Hi-Gain) DS-PAN-111-2 (Dual Hi-Gain)
DS-PAN-112	5	2	Yes	2	1	Yes	None DS-PAN-112-1 (Single Hi-Gain) DS-PAN-112-2 (Dual Hi-Gain)
DS-PAN-113	0	0	No	0	0	No	None

Specifications
Height: 4.0" (10.2 cm) Width: 12.4" (31.5 cm) Depth: 11.9" (30.2 cm) Weight: 4.6 lbs (2.1 kg)



DS-PAN-600 Series for Panasonic H2

Part Number	USB 2.0	Ethernet	VGA	Serial	Power Input (DC IN 15.6V)	Integrated Power
DS-PAN-601	3	1	1	1	1	No
DS-PAN-602	3	1	1	1	1	Yes
DS-PAN-603	0	0	0	0	0	No

Specifications
Height: 11.8" (30.0 cm) Width: 11.3" (28.7 cm) Depth: 4.0" (10.1 cm) Weight: 4.6 lbs (2.1 kg)

DS-PAN-210/220 Series for Panasonic CF-19

Part Number	USB 2.0	Serial	Integrated Power	Ethernet	VGA	Speaker/Mic	Antenna Connection
DS-PAN-211	4	2	No	1	1	Yes	None DS-PAN-211-2 (Dual Hi-Gain)
DS-PAN-212	4	2	Yes	1	1	Yes	None DS-PAN-212-2 (Dual Hi-Gain)
DS-PAN-213	0	0	No	0	0	No	None
DS-PAN-214*	3	2	No	1	1	Yes	None DS-PAN-214-2 (Dual Hi-Gain)
DS-PAN-221**	4	2	No	1	1	Yes	None DS-PAN-221-2 (Dual Hi-Gain)

* DS-PAN-214 Model features IP-65 Compliance upgrade
** DS-PAN-221 Model is backwards compatible with all generations of CF-18 & CF-19 computers (limited availability)

Specifications
Height: 3.3" (8.2 cm) Width: 10.9" (27.7 cm) Depth: 11.0" (27.9 cm) Weight: 3.8 lbs (1.7 kg)

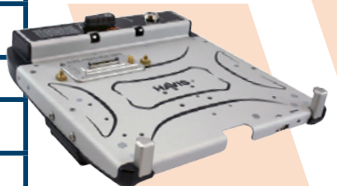

DS-PAN-700 Series for Panasonic FZ-G1

Part Number	USB 3.0	Ethernet	VGA	Serial	HDMI	Integrated Power	Antenna Connection
DS-PAN-701	2	1	1	1	1	No	None DS-PAN-701-2 (Dual Hi-Gain)
DS-PAN-702	2	1	1	1	1	Yes	None DS-PAN-702-2 (Dual Hi-Gain)
DS-PAN-703	0	0	0	0	0	No	None

Specifications
Height: 10.0" (25.5 cm) Width: 11.4" (28.9 cm) Depth: 4.3" (10.9 cm) Weight: 2.2 lbs (1.0 kg)

DS-PAN-410 Series for Panasonic CF-53

Part Number	Ethernet	USB 3.0	USB 2.0	VGA	Serial	HDMI	Antenna Connection	Integrated Power
DS-PAN-411	1	1	3	1	1	1	None DS-PAN-411-2 (Dual Hi-Gain)	No
DS-PAN-412	1	1	3	1	1	1	None DS-PAN-412-2 (Dual Hi-Gain)	Yes
DS-PAN-413	0	0	0	0	0	0	None	No

Specifications
Height: 3.4" (8.3 cm) Width: 13.8" (35.1 cm) Depth: 13.1" (33.2 cm) Weight: 6.6 lbs (3.0 kg)

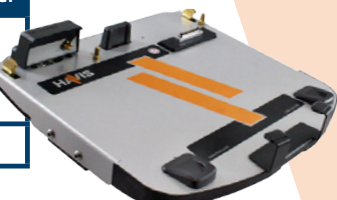

DS-PAN-900 Series for Panasonic FZ-M1

Part Number	USB 3.0	Ethernet	Serial	VGA	HDMI	Power Input (DC IN 16V)	Integrated Power	Antenna Connection
DS-PAN-901	2	1	1	1	1	1	No	None DS-PAN-901-2 (Dual Hi-Gain)
DS-PAN-902	2	1	1	1	1	1	Yes	None DS-PAN-902-2 (Dual Hi-Gain)
DS-PAN-903	0	0	0	0	0	0	No	None
DS-PAN-905	2	1	0	0	0	1	No	None DS-PAN-905-2 (Dual Hi-Gain)
DS-PAN-906	2	1	0	0	0	1	Yes	None DS-PAN-906-2 (Dual Hi-Gain)

For Panasonic FZ-B2

Part Number	USB 3.0	Ethernet	Serial	VGA	HDMI	Power Input (DC IN 16V)	Integrated Power	Antenna Connection
DS-PAN-903	0	0	0	0	0	0	No	None
DS-PAN-905	2	1	0	0	0	1	No	None DS-PAN-905-2 (Dual Hi-Gain)
DS-PAN-906	2	1	0	0	0	1	Yes	None DS-PAN-906-2 (Dual Hi-Gain)

Specifications
Height: 7.8" (19.8 cm) Width: 8.5" (21.6 cm) Depth: 2.8" (7.1 cm) Weight: TBD

DS-PAN-420 Series for Panasonic CF-54

Part Number	USB 3.0	Ethernet	VGA	Serial	HDMI	Integrated Power	Antenna Connection
DS-PAN-421	2	1	1	1	1	No	None DS-PAN-421-2 (Dual Hi-Gain)
DS-PAN-422	2	1	1	1	1	Yes	None DS-PAN-422-2 (Dual Hi-Gain)
DS-PAN-423	0	0	0	0	0	No	None

Specifications
Height: 3.0" (7.6 cm) Width: 15.1" (38.4 cm) Depth: 13.7" (34.8 cm) Weight: 5.4 lbs (2.5 kg)



Computer Model		Havis Docking Station	
		Part Number	Distinguishing Features
E6400 XFR* E6410 XFR*	E6420 XFR*	DS-DELL-110 Series	USB 3.0 Icon on the back of Docking Station
E6400 ATG* E6410 ATG*	E6420 ATG* E6430 ATG	DS-DELL-230 Series	Foot Pads on Top Plate & Macro Alignment Brackets

*USB will operate at USB 2.0 speed

NOTE - E6430 not released for XFR

Related Products

Part Number	Part Description	Docking Station Compatibility
EP5-DELL-XXX	<i>Extended Protection Plan</i> 5 year enhanced protection plan for Havis docking stations	<ul style="list-style-type: none"> DS-DELL-400 Series DS-DELL-610 Series DS-DELL-600 Series DS-DELL-700 Series
DS-DA-806	<i>Havis Screen Blanking Solution with Tamperproof Cover</i> Manage in-vehicle computer displays and prevent driver distraction.	<ul style="list-style-type: none"> DS-DELL-400 Series
DS-DA-801	<i>Havis Screen Blanking Solution powered by Blank-it</i> Manage in-vehicle computer displays and prevent driver distraction.	<ul style="list-style-type: none"> All Docking Stations
DS-DA-502	<i>Replacement Keys</i>	<ul style="list-style-type: none"> DS-DELL-110/230 Series DS-DELL-400 Series DS-DELL-300 Series
DS-DA-501	<i>Replacement Keys</i>	<ul style="list-style-type: none"> DS-DELL-600 Series
DS-DA-412	<i>Screen Stiffener</i>	<ul style="list-style-type: none"> DS-PAN-400 Series
DS-DA-408	<i>Screen Stiffener</i>	<ul style="list-style-type: none"> DS-DELL-110 Series DS-DELL-230 Series
DS-DA-403	<i>Screen Stiffener</i> (Included with DS-DELL-300 Series Docking Station)	<ul style="list-style-type: none"> DS-DELL-300 Series
DS-DA-319	<i>Replacement Power Cord</i> Power Cord for Docking Stations models with Internal Power Supplies.	<ul style="list-style-type: none"> DS-DELL-700 Series
DS-DA-316	<i>Power Cord</i> Power Cord for Docking Stations models with Internal Power Supplies.	<ul style="list-style-type: none"> DS-DELL-600 Series
DS-DA-225	<i>Card Reader Mounting Bracket</i> Mount an E-Seek Model 250/260 or a Magtek card reader to the side of the Docking Station	<ul style="list-style-type: none"> DS-DELL-400 Series
DS-DA-224	<i>Card Reader Mounting Bracket</i> Mount a Magtek 21040108 card reader to the side of the Docking Station	<ul style="list-style-type: none"> DS-DELL-110/230 Series DS-DELL-400 Series DS-DELL-300 Series
DS-DA-218	<i>Desktop Stand for Tablet Docking Stations</i> Durable stand for mounting tablet Docking Stations for use in the home or office.	<ul style="list-style-type: none"> DS-DELL-300 Series DS-DELL-610 Series DS-DELL-600 Series DS-DELL-700 Series
DS-DA-208	<i>Card Reader Mounting Bracket</i> Mount an E-Seek Model 250 card reader to the side of the Docking Station	<ul style="list-style-type: none"> DS-DELL-110/230 Series
DS-DA-104	<i>IP-65 Kit</i> Sealing Materials to ensure Docking Station is IP-65 Compliant	<ul style="list-style-type: none"> DS-DELL-700 Series
DS-DA-103	<i>Stylus Holder</i> Secure a wide array of styluses to the Docking Station	<ul style="list-style-type: none"> DS-DELL-600 Series
DS-DA-102	<i>USB Powered Keyboard Light</i> Soft red LED light illuminates the laptop keyboard for night viewing.	<ul style="list-style-type: none"> All Screen Stiffeners
LPS-105	90W External power supply and cable with cigarette lighter adaptor. (6' Cigarette Lighter Adaptor / 41" Plug-In Connector)	<ul style="list-style-type: none"> DS-DELL-110/230 Series DS-DELL-400 Series DS-DELL-300 Series
LPS-131	90W External power supply and cable with cigarette lighter adaptor. 12-16 V DC (6' Cigarette Lighter Adaptor / 41" Plug-In Connector)	<ul style="list-style-type: none"> DS-DELL-600 Series
LPS-134	90W External power supply and cable with cigarette lighter adaptor. (6' Cigarette Lighter Adaptor / 53" Y-Split Cable with Plug-In and Threaded Connectors) For use with Docking Station AND Havis Rugged Communications Hub (Part#DS-DA-602)	<ul style="list-style-type: none"> DS-DELL-110/230 Series DS-DELL-400 Series DS-DELL-300 Series
LPS-135	90W External power supply and cable with cigarette lighter adaptor. 12-32 V DC (6' Cigarette Lighter Adaptor / 41" Plug-In Connector)	<ul style="list-style-type: none"> DS-DELL-600 Series
LPS-137	90W External power supply and cable with cigarette lighter adaptor. (6' Cigarette Lighter Adaptor / 41" Plug-In Connector - With Ferrite Bead for EMI suppression)	<ul style="list-style-type: none"> DS-DELL-110/230 Series DS-DELL-400 Series DS-DELL-300 Series
LPS-138	90W External power supply and cable with cigarette lighter adaptor. 12-32 V DC (6' Cigarette Lighter Adaptor / 41" Plug-In Connector - With Ferrite Bead for EMI suppression)	<ul style="list-style-type: none"> DS-DELL-600 Series DS-DELL-610 Series
LPS-206	Power Supply Mounting Bracket Mount an LPS-138 power supply to Docking Station	<ul style="list-style-type: none"> DS-DELL-600 Series

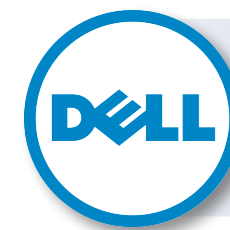

Havis Docking Solutions



DS-DELL-110 SERIES
Latitude E6400, E6410
& E6420 XFR



DS-DELL-230 SERIES
Latitude E6400, E6410
& E6420 ATG



DS-DELL-300 SERIES
Latitude XT2 XFR



DS-DELL-400 SERIES
Latitude 14 Rugged,
Latitude 12 & 14 Rugged Extreme



DS-DELL-600, 610, & 700 SERIES
Latitude 12 Rugged Tablet



Havis Docking Stations for Dell Rugged Computers

DS-DELL-110 Series for Latitude E6400, E6410, & E6420 XFR

Part Number	USB 2.0	USB 3.0*	Ethernet	Serial	VGA	eSATA	Parallel	HDMI	Keyboard/Mouse	Speaker/Mic	Antenna Connection
DS-DELL-111	3	2	1	1	1	1	1	2	Yes	Yes	None DS-DELL-111-3 GPS, WLAN (Wi-Fi), WWAN (Cellular)
DS-DELL-113	0	0	0	0	0	0	0	0	No	No	None

* - USB will operate at USB 2.0 speed

Specifications

Height: 3.7" (9.4 cm) Width: 13.6" (34.4 cm) Depth: 12.7" (32.3 cm) Weight: 6.6 lbs. (2.9 kg)

DS-DELL-230 Series for Latitude E6400, E6410, & E6420 ATG

Part Number	USB 2.0	USB 3.0	Serial	eSATA	Ethernet	VGA	Parallel	HDMI	Keyboard/Mouse	Speaker/Mic	Antenna Connection
DS-DELL-231	3	2	1	1	1	1	1	2	Yes	Yes	N/A
DS-DELL-233	0	0	0	0	0	0	0	0	No	No	N/A

Specifications

Height: 3.7" (9.4 cm) Width: 13.6" (34.4 cm) Depth: 12.7" (32.3 cm) Weight: 6.6 lbs. (2.9 kg)

DS-DELL-300 Series for Latitude XT2 XFR

Part Number	USB 2.0	Serial	DVI	Ethernet	VGA	Firewire	Speaker/Mic	Antenna Connection
DS-DELL-301	5	1	1	1	1	1	Yes	None DS-DELL-301-3 GPS, WLAN (Wi-Fi), WWAN (Cellular)

Specifications

Height: 3.7" (9.4 cm) Width: 13.2" (33.6 cm) Depth: 11.1" (28.2 cm) Weight: 6.9 lbs. (3.1 kg)

DS-DELL-400 Series for Latitude 14 Rugged, 12 & 14 Rugged Extreme

Part Number	USB 2.0	USB 3.0	Ethernet	Serial	VGA	HDMI	Speaker/Mic	Bundled Power Supply	Internal Power Supply	Dock Input Power	Antenna Connection (Triple Hi-Gain)
DS-DELL-401	1	3	1	2	1	1	Yes	No	No	19.5 V DC*	None DS-DELL-401-3
DS-DELL-402	1	3	1	2	1	1	Yes	Yes	No	19.5 V DC	None DS-DELL-402-3
DS-DELL-403**	0	0	0	0	0	0	0	No	No	n/a	None
DS-DELL-404	1	3	1	2	1	1	Yes	No	Yes	10-17 V DC	None DS-DELL-404-3
DS-DELL-405	1	3	1	0	0	0	Yes	No	No	19.5 V DC*	None DS-DELL-405-3
DS-DELL-406	1	3	1	0	0	0	Yes	Yes	No	19.5 V DC	None DS-DELL-406-3
DS-DELL-407	1	3	1	0	0	0	Yes	No	Yes	10-17 V DC	None DS-DELL-407-3

* Requires an external Dell authorized DC power supply

** Cradle only option (no electronics)

Specifications

Height: 10.8" (27.6 cm) Width: 12.4" (31.5 cm) Depth: 2.7" (6.9 cm) Weight: 5.5 lbs. (2.5 kg)



5 Year Enhanced Protection Plan Available

DS-DELL-600 Series for Latitude 12 Rugged Tablet

Part Number	USB 2.0 (front)	USB 3.0	Ethernet	Serial	VGA	DisplayPort	Bundled Power Supply	Internal Power Supply	Dock Input Power	Antenna Connection (Optional Dual Hi-Gain)
DS-DELL-601	1	2	1	2	1	1	No	No	19.5 V DC*	None DS-DELL-601-2
DS-DELL-602	1	2	1	2	1	1	Yes	No	19.5 V DC	None DS-DELL-602-2
DS-DELL-603**	0	0	0	0	0	0	No	No	n/a	None DS-DELL-603-2
DS-DELL-604	1	2	1	2	1	1	No	Yes	10-17 V DC	None DS-DELL-604-2

* Requires an external Dell authorized DC power supply

** Cradle only option (no electronics)

Specifications

Height: 14.1" (35.8 cm) Width: 13.7" (34.8 cm) Depth: 3.0" (7.5 cm) Weight: 4.7 lbs. (2.1 kg)



5 Year Enhanced Protection Plan Available

DS-DELL-610 Series for Latitude 12 Rugged Tablet

Part Number	USB 2.0 (front)	USB 3.0	Ethernet	Serial	VGA	DisplayPort	Bundled Power Supply	Internal Power Supply	Dock Input Power	Antenna Connection (Optional Dual Hi-Gain)
DS-DELL-611	1	2	1	2	1	1	No	No	19.5 V DC*	None DS-DELL-611-2
DS-DELL-612	1	2	1	2	1	1	Yes	No	19.5 V DC	None DS-DELL-612-2
DS-DELL-613**	0	0	0	0	0	0	No	No	n/a	None DS-DELL-613-2

* Requires an external Dell authorized DC power supply

** Cradle only option (no electronics)

Specifications

Height: 10.1" (25.6 cm) Width: 12.5" (31.6 cm) Depth: 2.9" (7.4 cm) Weight: 4.3 lbs. (2.0 kg)



5 Year Enhanced Protection Plan Available

DS-DELL-700 Series for Latitude 12 Rugged Tablet

Part Number	USB 2.0 (front)	USB 3.0	Ethernet	Serial	VGA	DisplayPort	Bundled Power Supply	Internal Power Supply	Dock Input Power	Antenna Connection
DS-DELL-701	0	3	1	1	0	0	No	Yes	12 VDC IN NOM (10-17 VDC IN)	None
DS-DELL-702	0	3	1	1*	0	0	No	Yes	12 VDC IN NOM (10-17 VDC IN)	None
DS-DELL-703	0	3	1	1**	0	0	No	Yes	12 VDC IN NOM (10-17 VDC IN)	None
DS-DELL-704 (IP-65 Compliant)	0	3	1	1	0	0	No	Yes	12 VDC IN NOM (10-17 VDC IN)	None
DS-DELL-705 (IP-65 Compliant)	0	3	1	1*	0	0	No	Yes	12 VDC IN NOM (10-17 VDC IN)	None
DS-DELL-706 (IP-65 Compliant)	0	3	1	1**	0	0	No	Yes	12 VDC IN NOM (10-17 VDC IN)	None

PKG-DS-DELL-7XX Available (Packages with Havis Screen Blanking Solution)

* Powered Serial Port (+5 V on pin #9)

** Powered Serial Port (+12 V on pin #9)

Specifications

Height: 7.7" (19.5 cm) Width: 12.7" (32.2 cm) Depth: 2.6" (6.7 cm) Weight: 2.2 lbs. (1.1 kg)



5 Year Enhanced Protection Plan Available

Related Havis Products for Getac Computing Solutions

Getac Havis Docking Solutions

Part Number	Part Description	Docking Station
Enhanced Protection Plan		
EP5-GTC-XXX	5 year Enhanced Protection Plan for Havis Docking Stations	• All Docking Stations
Power Supplies		
LPS-115	95W External power supply and cable with cigarette lighter adaptor. <i>(6' Cigarette Lighter Adaptor / 3' 4-pin Circular Connector)</i>	• DS-GTC-100 Series
LPS-116	95W External power supply and cable with cigarette lighter adaptor. <i>(6' Cigarette Lighter Adaptor / 3' Straight Tip Connector)</i>	• DS-GTC-200 Series • DS-GTC-310 Series • DS-GTC-410 Series • DS-GTC-510 Series
LPS-136	120W External power supply and cable with cigarette lighter adaptor. <i>(6' Cigarette Lighter Adaptor / 3' Straight Tip Connector)</i>	• DS-GTC-600 Series
LPS-139	55W External Getac power supply and cable with cigarette lighter adaptor.	• DS-GTC-700 Series
LPS-204	Power Supply Mounting Bracket Attach the LPS-136 power supply to Docking Station	• DS-GTC-600 Series
Screen Stiffeners		
DS-DA-411	Secure your laptop screen to prevent excess wear and reduce vibration while in use.	• DS-GTC-100 Series
DS-DA-413	Secure your laptop screen to prevent excess wear and reduce vibration while in use.	• DS-GTC-310 Series
DS-DA-416	Secure your laptop screen to prevent excess wear and reduce vibration while in use. Dual left and right side supports.	• DS-GTC-310 Series
DS-DA-418	Secure your laptop screen to prevent excess wear and reduce vibration while in use.	• DS-GTC-600 Series
Card Reader Brackets		
DS-DA-213	Mount an E-Seek Model 250 card reader to the side of the Docking Station.	• DS-GTC-100 Series
DS-DA-223	Mount a Magtek 21040108 card reader to the side of the Docking Station.	• DS-GTC-100 Series • DS-GTC-200 Series
DS-DA-231	Mount an E-Seek Model 250 and 260 card reader to the side of the Docking Station.	• DS-GTC-600 Series
DS-DA-232	Mount a Magtek card reader to either side of the Docking Station.	• DS-GTC-600 Series
Accessories		
DS-DA-102	USB Powered Keyboard Light Soft red LED light illuminates the laptop keyboard for night viewing.	• All Docking Stations
DS-DA-214	Computer Side Covers Provides tamper protection and hard drive theft prevention	• DS-GTC-100 Series
DS-DA-233	Cable Cover Cable Cover for Havis Docking Station	• DS-GTC-410 Series
DS-DA-501	Replacement Keys Set of two (2) docking station replacement keys.	• DS-GTC-100 Series • DS-GTC-200 Series • DS-GTC-510 Series
DS-DA-502	Replacement Keys Set of two (2) docking station replacement keys.	• DS-GTC-310 Series • DS-GTC-410 Series
DS-DA-503	Replacement Keys Set of two (2) docking station replacement keys.	• DS-GTC-600 Series • DS-GTC-700 Series
DS-DA-801	Screen Blanking Solution powered by Blank-it Manage in-vehicle computer displays and prevent driver distraction.	• All Docking Stations
DS-DA-802	Screen Blanking Solution powered by Blank-it with Tamperproof Cover Manage in-vehicle computer displays and prevent driver distraction.	• DS-GTC-200 Series
DS-DA-803	Screen Blanking Solution powered by Blank-it with Tamperproof Cover Manage in-vehicle computer displays and prevent driver distraction.	• DS-GTC-410 Series
DS-DA-809	Screen Blanking Solution powered by Blank-it with Tamperproof Cover Manage in-vehicle computer displays and prevent driver distraction.	• DS-GTC-600 Series



Havis Docking Stations for

DS-GTC-100 Series for Getac V100 & V200 Notebooks

Part Number	Compatible Computer	USB 2.0	Ethernet	Serial	Video Capture	Speaker/Mic	Power Input (DC IN 19V)	Included Power Supply	Antenna Connection
DS-GTC-101	V100 & V200	4	1	2	1	1 each	1	No	None V100 - DS-GTC-101-2 (Dual Pass-Through) V200 - DS-GTC-101-3 (Triple Pass-Through)
DS-GTC-102	V100 & V200	4	1	2	1	1 each	1	Yes	None V100 - DS-GTC-102-2 (Dual Pass-Through) V200 - DS-GTC-102-3 (Triple Pass-Through)
DS-GTC-103*	V100 & V200	0	0	0	0	0	0	No	None

* Cradle only option (no electronics)

Specifications

Height: 3.3" (8.2 cm) Width: 10.9" (27.7 cm) Depth: 11.2" (28.4 cm) Weight: 4.3 lbs (1.9 kg)

DS-GTC-200 Series for Getac F110 Tablets

Part Number	USB 2.0	USB 3.0	VGA	Ethernet	Serial	HDMI	Speaker/Mic	Power Input (DC IN 19V)	Included Power Supply	Antenna Connection
DS-GTC-201	3	1	1	1	2	1	1 each	1	No	None DS-GTC-201-3 (Triple Pass-Through)
DS-GTC-202	3	1	1	1	2	1	1 each	1	Yes	None DS-GTC-202-3 (Triple Pass-Through)
DS-GTC-203*	0	0	0	0	0	0	0	0	No	None DS-GTC-203-3* (Triple Pass-Through)

* Cradle only option (no electronics)

Specifications

Height: 11.1" (28.2 cm) Width: 8.7" (22.2 cm) Depth: 4.4" (11.1 cm) Weight: 2.1 lbs (0.95 kg)

DS-GTC-310 Series for Getac V110 Convertible Notebooks

Part Number	USB 2.0	USB 3.0	Ethernet	Serial	VGA	HDMI	Speaker/Mic	Power Input (DC IN 19V)	Included Power Supply	Antenna Connection
DS-GTC-301	3	1	1	2	1	1	1 each	1	No	None DS-GTC-301-3 (Triple Pass-Through)
DS-GTC-302	3	1	1	2	1	1	1 each	1	Yes	None DS-GTC-302-3 (Triple Pass-Through)
DS-GTC-303*	0	0	0	0	0	0	0	0	No	No

* Cradle only option (no electronics)

Specifications

Height: 2.8" (7.1 cm) Width: 11.8" (29.9 cm) Depth: 11.0" (27.9 cm) Weight: 5.2 lbs (2.3 kg)

DS-GTC-410 Series for Getac T800 Tablets

Part Number	USB 3.0	Ethernet	Serial	Power Input (DC IN 19V)	Included Power Supply	Antenna Connection
DS-GTC-401	2	1	1	1	No	None DS-GTC-401-3 (Triple Pass-Through)
DS-GTC-402	2	1	1	1	Yes	None DS-GTC-402-3 (Triple Pass-Through)
DS-GTC-403*	0	0	0	0	No	None DS-GTC-403-3* (Triple Pass-Through)

* Cradle only option (no electronics)

Specifications

Height: 8.1" (20.7 cm) Width: 7.0" (17.8 cm) Depth: 3.5" (8.9 cm) Weight: 1.6 lbs (0.75 kg)

Getac Fully Rugged Computers

DS-GTC-510 Series for Getac RX10 Rugged Tablets

Part Number	USB 3.0	Ethernet	Serial	Included Power Supply	Antenna Connection
DS-GTC-501	2	1	1	No	None DS-GTC-501-3 (Triple Pass-Through)
DS-GTC-502	2	1	1	Yes	None DS-GTC-502-3 (Triple Pass-Through)
DS-GTC-503*	0	0	0	No	None DS-GTC-503-3* (Triple Pass-Through)
DS-GTC-504	2	1	1	Yes, Internal Power	None DS-GTC-504-3 (Triple Pass-Through)

* Cradle only option (no electronics)

Specifications

Height: 11.4" (28.9 cm) Width: 10.1" (25.6 cm) Depth: 3.9" (9.9 cm) Weight: 2.6 lbs (1.2 kg)

DS-GTC-600 Series for Getac S410 Notebooks

Part Number	USB 2.0	USB 3.0	Ethernet	Serial	VGA	HDMI	Speaker/Mic	Power Input	Remote Power Input	Included Power Supply	Antenna Connection
DS-GTC-601	3	1	1	1	1	1	1 each	19 VDC IN	No	No	None DS-GTC-601-3 (Triple Pass-Through)
DS-GTC-602	3	1	1	1	1	1	1 each	19 VDC IN	No	Yes	None DS-GTC-602-3 (Triple Pass-Through)
DS-GTC-603*	0	0	0	0	0	0	0	0	No	No	None DS-GTC-603-3* (Triple Pass-Through)
DS-GTC-604	3	1	1	1	1	1	1 each	12 VDC IN	No	Yes, Internal Power	None DS-GTC-604-3 (Triple Pass-Through)
DS-GTC-605	3	1	1	1	1	1	1 each	19 VDC IN	Yes	No	None DS-GTC-605-3 (Triple Pass-Through)

* Cradle only option (no electronics)

Specifications

Height: 2.8" (7.1 cm) Width: 11.8" (29.9 cm) Depth: 11.0" (27.9 cm) Weight: 5.1 lbs (2.3 kg)

DS-GTC-700 Series for Getac Z710 & ZX70 Rugged Tablets

Part Number	Docking Connector	USB 2.0	Ethernet	Serial	HDMI	Speaker	Power Input	Included Power Supply	Antenna Connection
DS-GTC-701	JAE	2	1	1	1	1	12 VDC IN	No	None DS-GTC-701-2 (Dual Pass-Through)
DS-GTC-703*	n/a	0	0	0	0	0	n/a	No	None DS-GTC-703-3 (Dual Pass-Through)
DS-GTC-704	POGO	2	1	1	1	1	12 VDC IN	No	None DS-GTC-704-2 (Dual Pass-Through)
DS-GTC-705	POGO	0	0	0	0	1	12 VDC IN	No	None DS-GTC-705-2 (Dual Pass-Through)
DS-GTC-706*	n/a	0	0	0	0	0	n/a	Yes	None DS-GTC-706-2 (Dual Pass-Through)

* Cradle only option (no electronics)

Specifications

Height: 8.7" (22.1 cm) Width: 9.2" (23.4 cm) Depth: 2.9" (7.4 cm) Weight: 1.5 lbs (0.68 kg)