

TRUST SUPER TUNING SYSTEMS AIMED AT REAL COMPETITORS

---

# *GRiddy* Intelligent Informeter

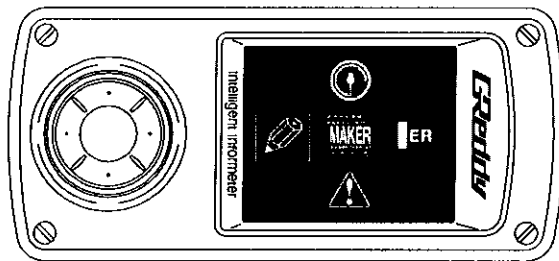

Please read this manual before installing and using this product.

---

**TRUST**

**PARTS LIST**

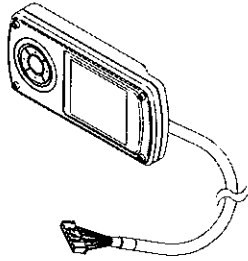

Intelligent Informeter Main Unit x 1

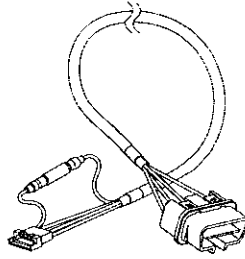

OBD Harness x 1

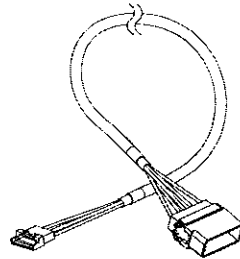

NON-OBD Harness x 1

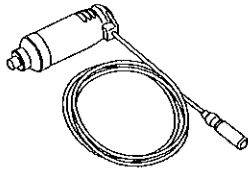

Cigarette Lighter Plug x 1

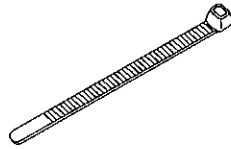

Zip Ties x 2



Double-sided Tape x 2

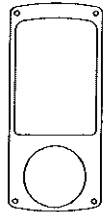

Color Insert Sheet x 9

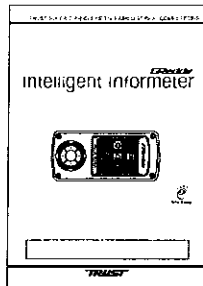

Instruction Manual x 1

## **PRODUCT FEATURES**

### **[ Simple installation ]**

- The supplied ISO14230 Diagnostic (OBD II) connector and non-OBD II Nissan connector makes installation very simple. Just connect the harness to the vehicle's diagnostic port and monitor the ECU data instantly.

### **[ Easy to see color LCD display ]**

- By using color LCD display, the data is very colorful and easy to see.
- By setting the warning range and color, the driver can monitor the vehicle's condition by looking at the color change on the display.

### **[ Dress up the interior ]**

- The button back light can be customized to illuminate in various colors. White, Cyan, Purple, Amber, Pink, Green or gradation mode can be selected. The button back light color will also change according to the warning settings to notify the driver of the vehicles condition.

### **[ Data logging capabilities ]**

- This unit is able to record up to 6 selected data. The recording method can also be set by the user to record more detailed data.

### **[ Customize your own case ]**

- With provided color insert sheets, the case can be customized to match the vehicle's interior. It is also easy to create a one off insert sheet by tracing the pattern to any decorated sheets.

### **[ Flexible mounting ]**

- By rotating the display 180 degrees, the main unit can be mounted with the buttons on the right or left. This feature makes mounting of the unit very flexible.

## INSTALLATION

### [ When installing on a non-OBD Nissan vehicle ]

\*The OBD connector location is an example. Please refer to factory service manual for detailed location.

\*Nissan vehicles only.

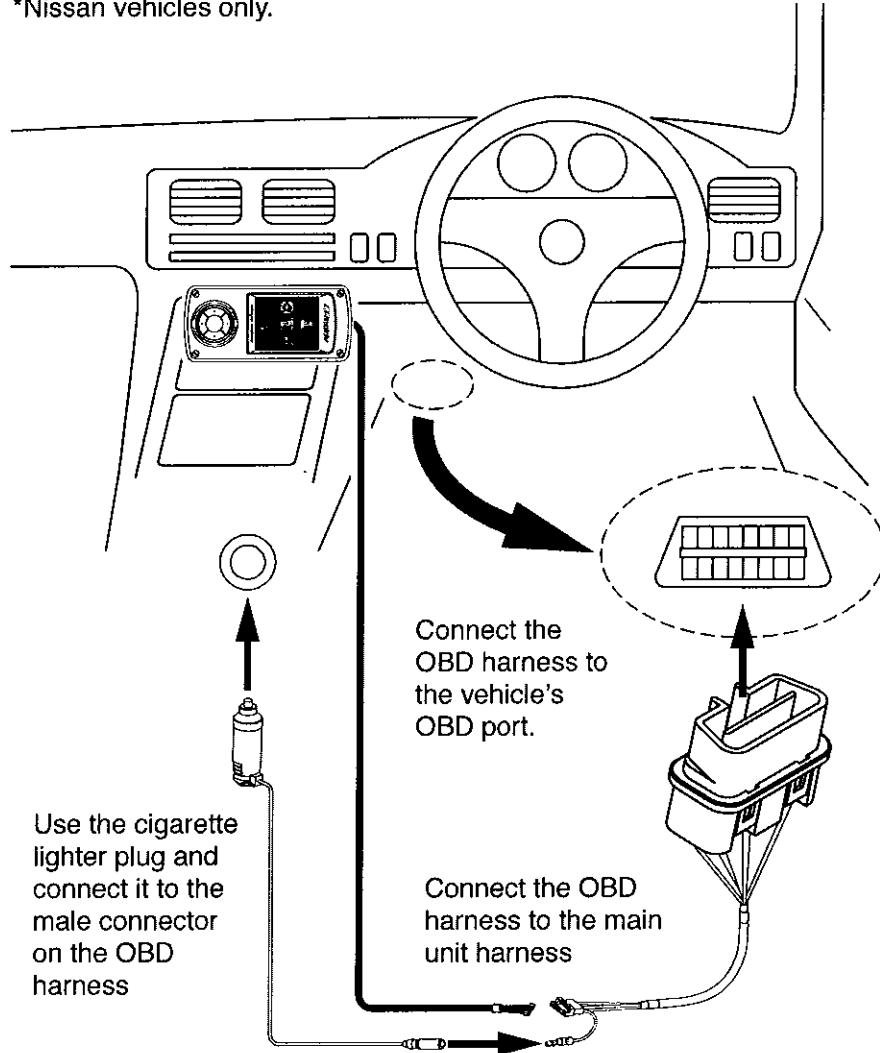

## INSTALLATION

### [ When installing on a OBD II equipped vehicle ]

\*The OBD connector location in an example. Please refer to factory service manual for detailed location. For Non-OBD Nissan vehicle only.

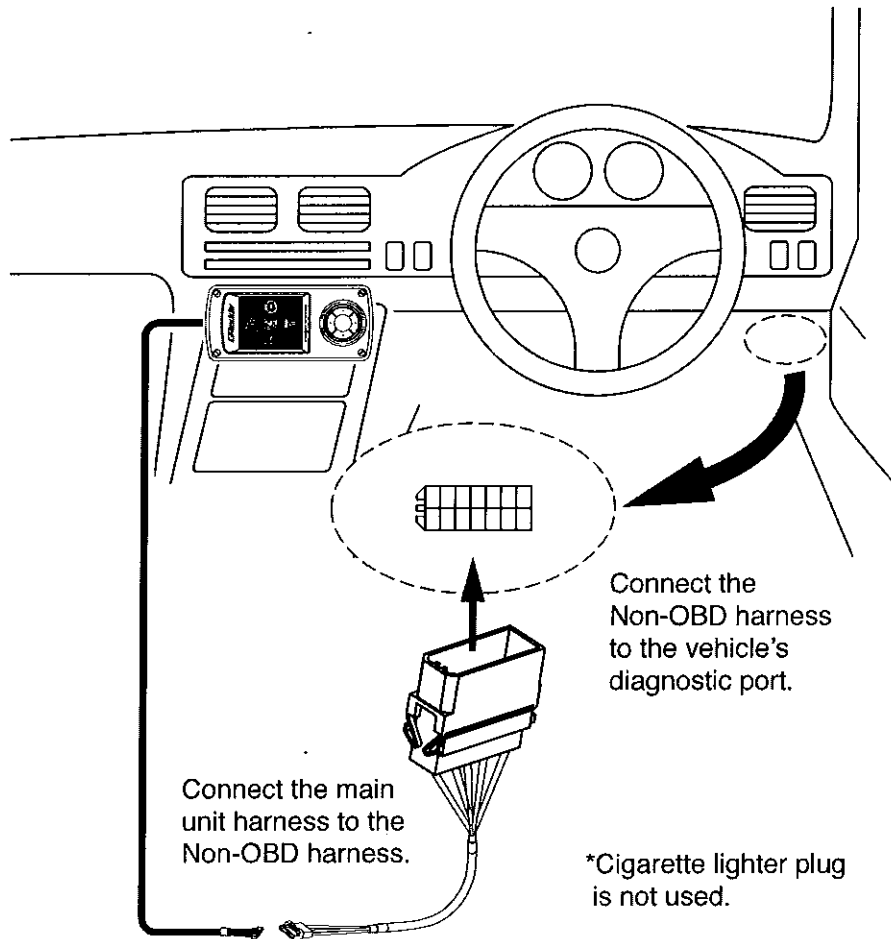

## INSTALLATION

### [ Mounting the main unit using double sided tape ]

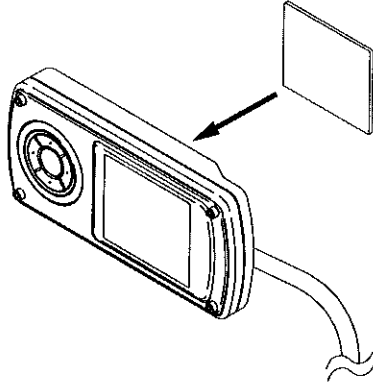

### [ Mounting the main unit using a cell phone holder ]

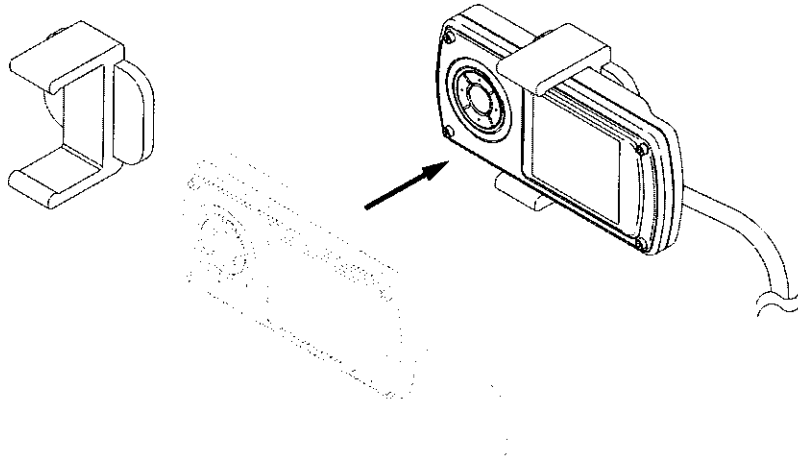

•For a detailed installation for the cell phone holder, please refer to the instruction supplied with the holder.

## CONTROL FUNCTIONS

### [ Intelligent Informeter control functions ]

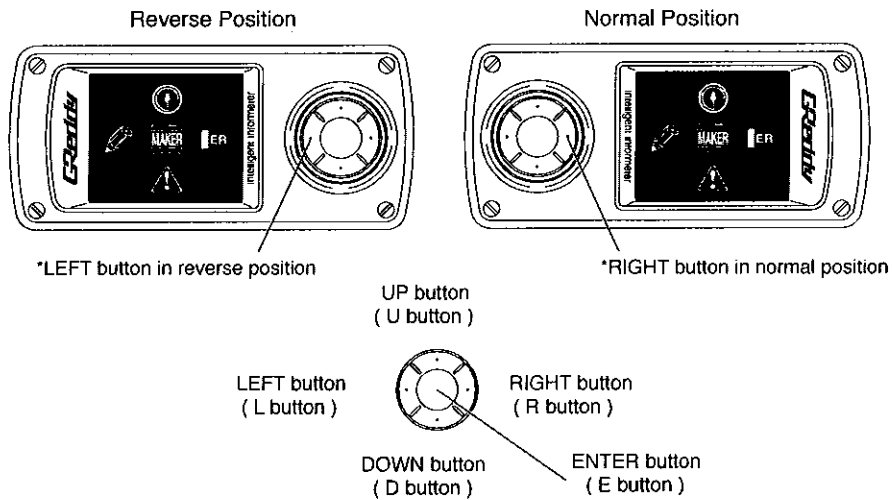

- UP button ( U button ) •Used to scroll the menu up and to increase the input value.
- DOWN button ( D button ) •Used to scroll the menu down and to decrease the input value.
- LEFT button ( L button ) •Used to move left in each menu and to return to the previous menu. (Back button)
- RIGHT button ( R button ) •Used to move right in each menu and to select Record mode.
- ENTER button ( E button ) •Used to confirm the menu selection and to confirm the setting.

Main Unit Dimensions : H 46mm x W 100mm x T 20mm

## Before using . . .

### [ Setting the unit LANGUAGE ]

•This unit can be displayed in two languages : English or Japanese.

\*This unit is preset to English language.

#### To change the language setting

•In the main menu, select the BASIC SETTING icon and confirm by pushing ENTER button.

•In the BASIC SETTING menu, select LANGUAGE and confirm by pushing ENTER button.

•Select the desired language and confirm by pushing ENTER button.

•To return to the main menu push the LEFT button couple times.

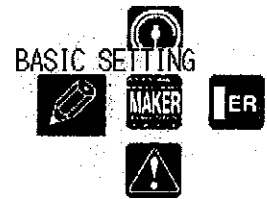

↓

LANGUAGE	ENGLISH
UNIT	km/h
CONTRAST	16
BACK LIGHT	16
SW LIGHT	WHITE
BUZZER	OFF
PERCENT	
COLOR SETTING	

↓

LANGUAGE	ENGLISH
UNIT	km/h
CONTRAST	16
BACK LIGHT	16
SW LIGHT	WHITE
BUZZER	OFF
PERCENT	
COLOR SETTING	

↓

言語	英語
単位	km/h
コントラスト	16
バックライト	16
スイッチライト	ホワイト
ブザー	オフ
パーセント	
イロセット	



## VEHICLE SETTING

### [ To set the vehicle type ]

•Select the center icon "MAKER" and confirm by pushing ENTER button.

•List of manufacturer's names will display. Select the vehicle this unit is being used on and confirm.

•The unit will check the connection and application. If the unit is connected properly, and the correct vehicle type is selected, the vehicle type will display above the "MAKER" icon in the main menu.

•The unit is now ready to monitor the vehicle's conditions.

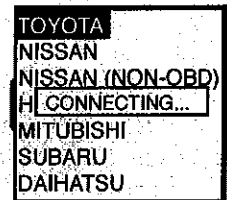
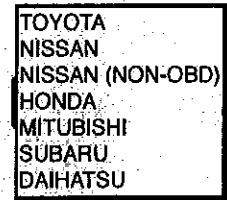
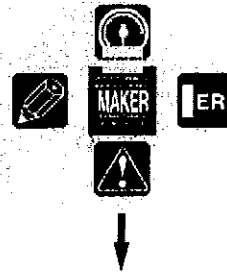

# FLOW CHART

[ Use the chart below to check the setting ]

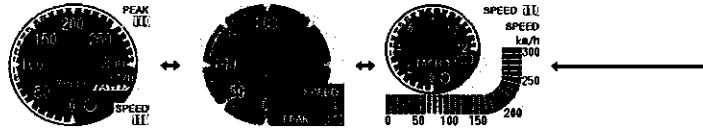

TOYOTA  
NISSAN  
NISSAN (NON-OBD)  
HONDA  
MITSUBISHI  
SUBARU  
DAIHATSU

## Vehicle List

ENGLISH  
UNIT km/h  
CONTRAST 16  
BACK LIGHT ENGLISH 16  
SW LIGHT WHITE  
BUZZER OFF  
PERCENT  
COLOR SETTING

COLOR SETTING  
METERBOARD BLUE  
NEEDLE

ENGLISH  
UNIT km/h  
CONTRAST 16  
BACK LIGHT 16  
SW LIGHT WHITE  
BUZZER OFF  
PERCENT  
COLOR SETTING

BASIC SETTING

CONTRAST 18  
BACKLIGHT 16  
SW LIGHT WHITE  
BUZZER NORMAL  
PERCENT  
COLOR SETTING  
DISPLAY  
REC MODE REVERSE NORMAL

## BASIC SETTING Menu

WARNING ZONE

SPEED	CONDITION	720
TACHO	RED	7000
WATER	YELLOW	3500
IGNITION	LOW	
INACT	YELLOW	OFF
INACT	RED	OFF



## MONITOR

### [ Selecting and setting the NEEDLE METER in MONITOR mode ]

This feature allows our easy to read analog gauge design to display the data digitally on the LCD screen.

- Select the MONITOR icon in the main menu and confirm.
- Select the NEEDLE METER from the MONITOR display type menu and confirm.
- SPEED is set initially. To change the data to monitor, press the E button to highlight the title.
- Once the title is highlighted, press the E button again to display the data list.  
(This step must be done with in 5 sec. or the highlight will disappear)
- Select the desired data to monitor and confirm.

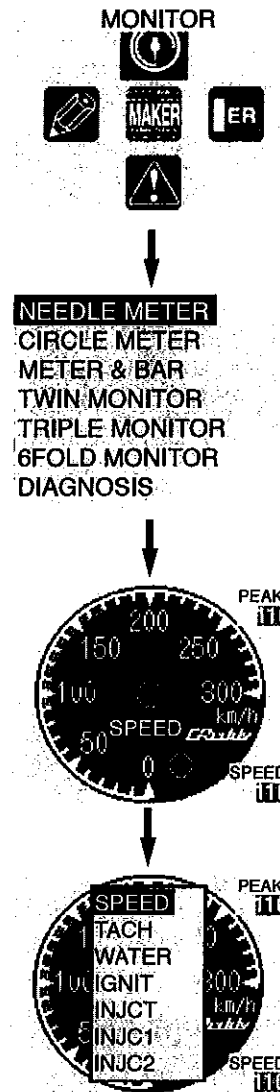

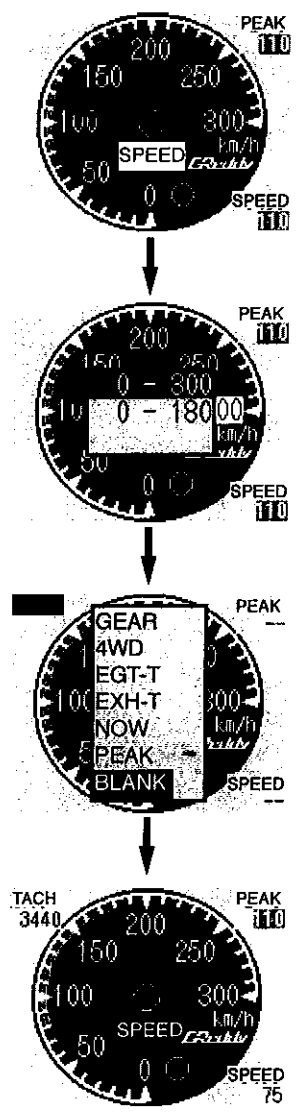

### Changing the range

The range of the gauge can be adjusted.

To change the range;

- Press the E button to highlight the title.
- Once the title is highlighted, press UP or DOWN to highlight the value on the gauge.
- Select the desired range and confirm.

### SUB DATA

In the NEEDLE METER mode, there are options to display up to 3 sub data in the corners

- Press the E button to highlight the title.
- Once the title is highlighted, press UP or DOWN to highlight one of the corner in the display and press E button to display the menu.
- Select the desired data to display and confirm.

## MONITOR (CONT'D)

[ Selecting and setting the  
CIRCLE METER in MONITOR mode ]

•The CIRCLE METER was designed with an easy to see pie graph with the smoothness of an analog gauge. With a simple setting, the warning zone can be clearly displayed in three colors changing from green to yellow to red. The driver can simply monitor the change in color and drive safely without staring at the gauge.

•Select the MONITOR icon in the main menu and confirm.

•Select the CIRCLE METER from the MONITOR display type menu and confirm.

•SPEED is set initially. To change the data to monitor, press the E button to highlight the title.

•Once the title is highlighted, press the E button again to display the data list.  
(This step must be done with in 5 sec. or the highlight will disappear)

•Select the desired data to monitor and confirm.

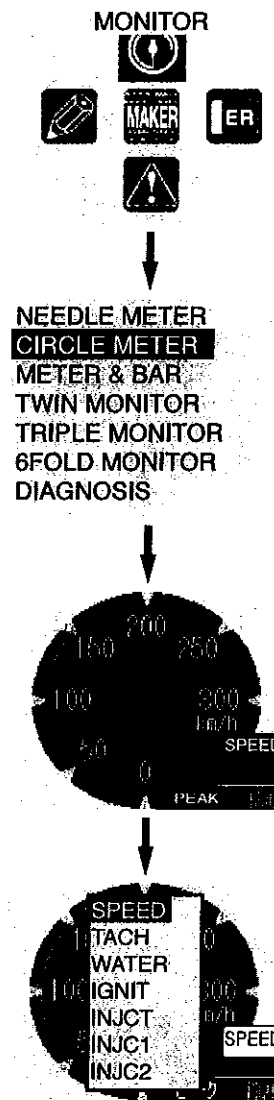

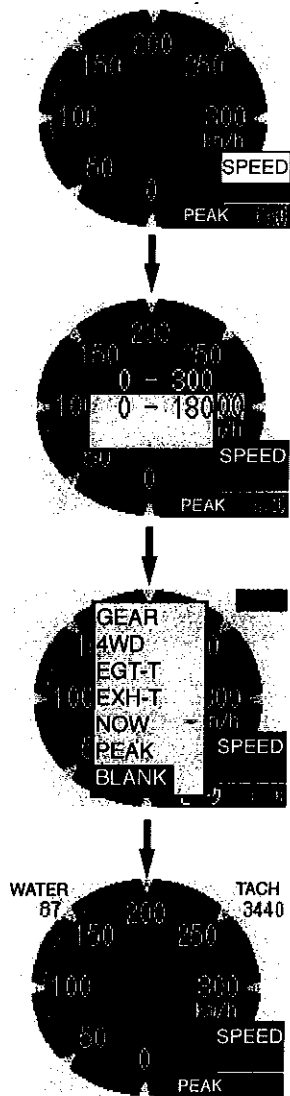

### Changing the range

The range of the gauge can be adjusted.

To change the range;

- Press the E button to highlight the title.
- Once the title is highlighted, press UP or DOWN to highlight the value on the gauge.
- Select the desired range and confirm.

### SUB DATA

In the NEEDLE METER mode, there are options to display up to 3 sub data in the corners

- Press the E button to highlight the title.
- Once the title is highlighted, press UP or DOWN to highlight one of the displays in the corner and press E button to display the menu.
- Select the desired data to display and confirm.

## MONITOR (CONT'D)

[ Selecting and setting the  
METER & BAR in MONITOR mode ]

•The METER & BAR setting brings the race car look & feel in to the cockpit. This feature will display an analog guage and a bar type meter.

•Select the MONITOR icon in the main menu and confirm.

•Select the METER & BAR from the MONITOR display type menu and confirm.

•TACH & SPEED is set initially. To change the data to monitor, press the E button to highlight the title.

•Once the title is highlighted, press the E button again to display the data list.  
(This step must be done with in 5 sec. or the highlight will disappear)

•Select the desired data to monitor and confirm.

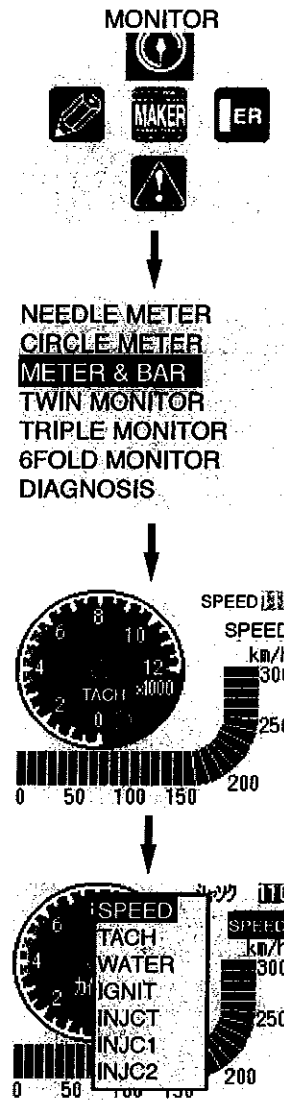



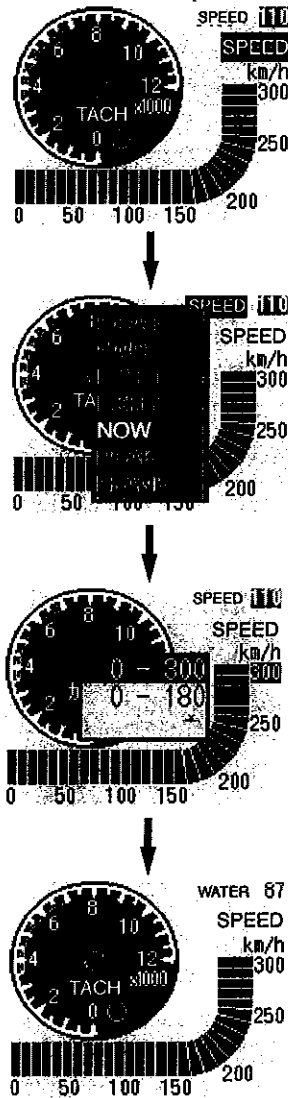

### Changing the range

Range of the gauge can be adjusted.

To change the range;

- Press the E button to highlight the title.

- Once the title is highlighted, press UP or DOWN to highlight the value on the gauge.

- Select the desired range and confirm.

### SUB DATA

In the NEEDLE METER mode, there are options to display a 3rd digital sub data in the top right corner.

- Press the E button to highlight the title.

- Once the title is highlighted, press UP or DOWN to highlight one of the corner in the display and press E button to display the menu.

- Select the desired data to display and confirm.

## MONITOR (CONT'D)

[ Selecting and setting the  
TWIN MONITOR in MONITOR mode ]

•TWIN MONITOR mode will display 2 large digital readings on the screen.

•Select the MONITOR icon in the main menu and confirm.

•Select the TWIN MONITOR from the MONITOR display type menu and confirm.

•SPEED & TACH are set initially. To change the data to monitor, press the E button to highlight the title.

•Once the title is highlighted, press the E button again to display the data list.  
(This step must be done within 5 sec. or the highlight will disappear)

•Select the desired data to monitor and confirm.

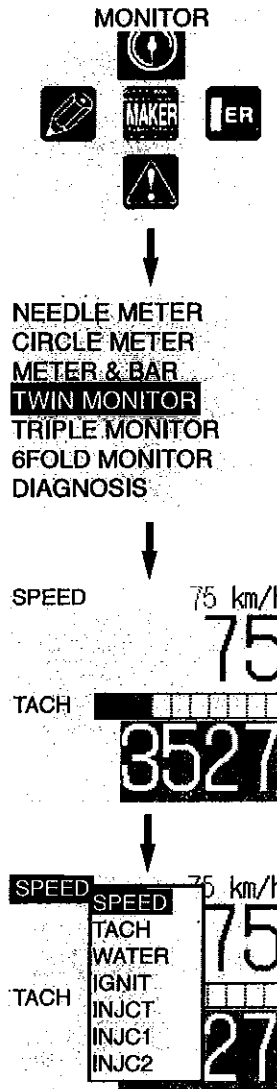

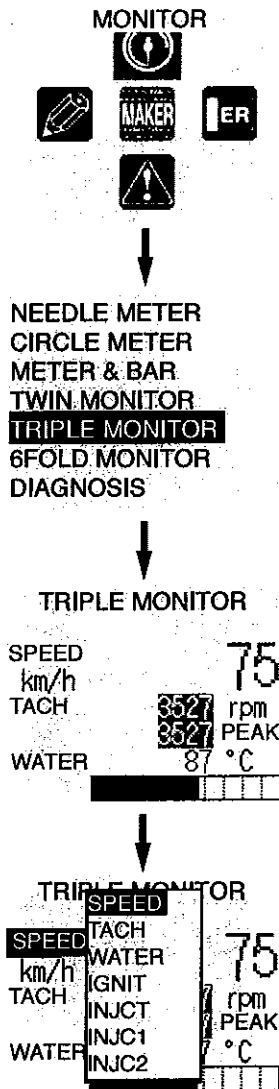

[ Selecting and setting the TRIPLE MONITOR in MONITOR mode ]

- TRIPLE MONITOR mode will display 3 different peices of data.

- Select the MONITOR icon in the main menu and confirm.

- Select the TRIPLE MONITOR from the MONITOR display type menu and confirm.

- SPEED, TACH, WATER temp are set initially. To change the data to monitor, press the E button to highlight the title.

- Once the title is highlighted, press the E button again to display the data list.

(This step must be done with in 5 sec. or the highlight will disappear)

- Select the desired data to monitor and confirm.

## MONITOR (CONT'D)

[ Selecting and setting the TRIPLE MONITOR in MONITOR mode ]

- Select 6FOLD MONITOR to display 6 different peices of data.
- Select the MONITOR icon in the main menu and confirm.
- Select the 6FOLD MONITOR from the MONITOR display type menu and confirm.
- 6 different data are set initially. To change the data to monitor, press the E button to highlight the title.
- Once the title is highlighted, press the E button again to display the data list.  
(This step must be done with in 5 sec. or the highlight will disappear)
- Select the desired data to monitor and confirm.

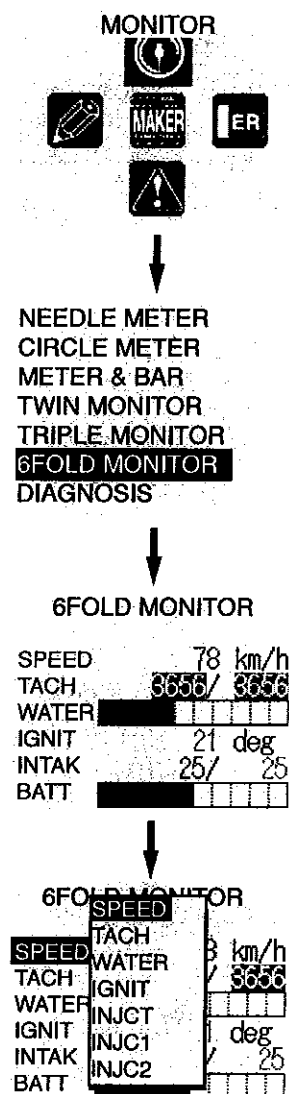

[ Selecting DIAGNOSIS in MONITOR mode ]

•This mode will display number of the error codes stored in the ECU.

•Select the MONITOR icon in the main menu and confirm.

•Select DIAGNOSIS from the MONITOR display type menu and confirm.

•When there are error codes stored in the ECU, the number of the codes stored will be displayed.

•This unit is not able to display the actual error code or the error description.

•If there are any codes, please have the error check as soon as possible.

•Depending on the vehicle the error count may be different from the actual number of errors.



## BASIC SETTING

Select BASIC SETTING from the main menu to customize the unit.

### [ LANGUAGE ]

•Select ENGLISH or JAPANESE.

### [ UNIT ]

•Select km/h for metric units and MPH for standard units. km/h will display km/h for speed and °C for temp. MPH will display MPH for speed and °F for temp.

### [ CONTRAST, BACKLIGHT ]

•LCD's contrast and backlight can be adjusted by 1~32 steps for best visibility.

### [ SW LIGHT ]

•The button back light can be customized to illuminate in various colors. White, Cyan, Purple, Amber, Pink, Green or gradation mode can be selected.

### [ BUZZER ]

•The button sound can be turned ON or OFF.

### [ PERCENT ]

The injector duration, airflow meter voltage, and throttle voltage can be changed to display in percentage.

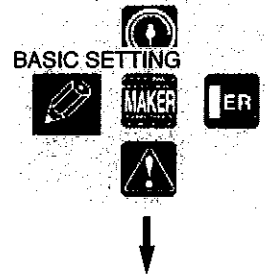

```

CONTRAST          16
BACKLIGHT         16
SW LIGHT          WHITE
BUZZER
PERCENT
COLOR SETTING
DISPLAY DIR      REVERSE
REC MODE         NORMAL
    
```

```

CONTRAST          16
BACKLIGHT         16
SW LIGHT          WHITE
BUZZER           CYAN
PERCENT          PURPLE
COLOR SETTING    AMBER
DISPLAY DIR      PINK
REC MODE         YELLOW
    
```

```

CONTRAST          16
BACKLIGHT         16
SW LIGHT          GRADATION
BUZZER
PERCENT
COLOR SETTING
DISPLAY DIR      REVERSE
REC MODE         NORMAL
    
```

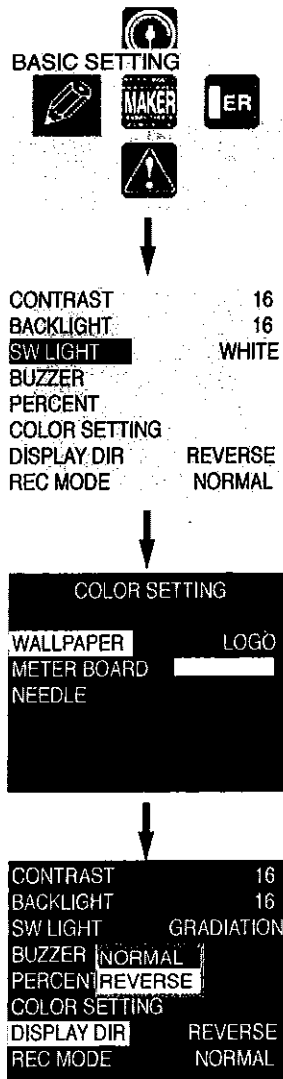

[ COLOR SETTING ]

•The display color can be changed to black, red, green, yellow, blue, magenta, cyan, white, darkblue, light blue, light gray, dark gray, dark green, and dark amber. In addition to the 14 colors, a GReddy logo and 3 GReddy cars can also be selected as wallpaper.

•METER BOARD and NEEDLE colors can be selected from the same 14 colors.

[ DISPLAY DIR ]

•Display rotation can be changed depending on the rotation the unit being mounted.

[ REC MODE ]

•The Recording cycle can be adjusted to SMOOTH, STANDARD, or LONG setting.

## WARNING

[ Warning setting ]

•This feature can be used to set the warning light and alarm when the monitored data exceeds the set caution and warning points.

•Select WARNING from the main menu to customize the unit.

•Select the WARNING ZONE to set the warning point for each monitored items.

•Select the monitored items from the list and set the yellow zone (caution zone) and red zone (warning zone) values.

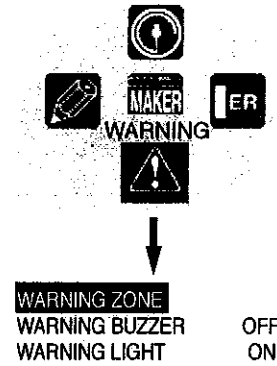

WARNING ZONE

SPEED	HIGH	rpm
TACH	RED	7000
WATER	YELLOW	3500
IGNIT	LOW	
INJCT	YELLOW	OFF
INJ1	RED	OFF

WARNING ZONE

SPEED	HIGH	rpm
TACH	RED	7000
WATER	YELLOW	3500
IGNIT	LOW	
INJCT	YELLOW	OFF
INJ1	RED	OFF



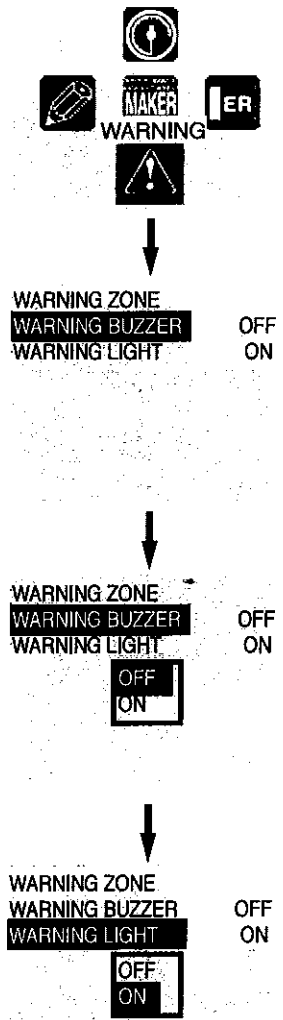

[ Warning setting ]

•A WARNING BUZZER will activate the caution and warning alarm when monitored data exceeds the set caution and warning points.

•Select the WARNING BUZZER to turn the warning alarm ON or OFF.

•Once the WARNING BUZZER is highlighted, press E and select ON or OFF. Press E again to confirm.

•WARNING LIGHT will activate the caution and warning light when monitored data exceeds the set caution and warning points.

•Select the WARNING LIGHT to turn the warning light ON or OFF.

•Once the WARNING LIGHT is highlighted, press E and select ON or OFF. Press E again to confirm.

## INITIALIZE

### [ INITIALIZE ]

This feature is used to re set the unit. The peak memory and the unit also can be reset. When the unit is reset, the vehicle setting, basic setting, and warning points will all be cleared to the factory settings.

•Select INITIALIZE in the main menu.

#### To clear the peak memory,

•Select PEAK CLEAR in the INITIALIZE menu and confirm.

•Select YES or NO and confirm.

#### To reset the unit,

•Select RESET in the INITIALIZE menu and confirm.

•Select YES or NO and confirm.

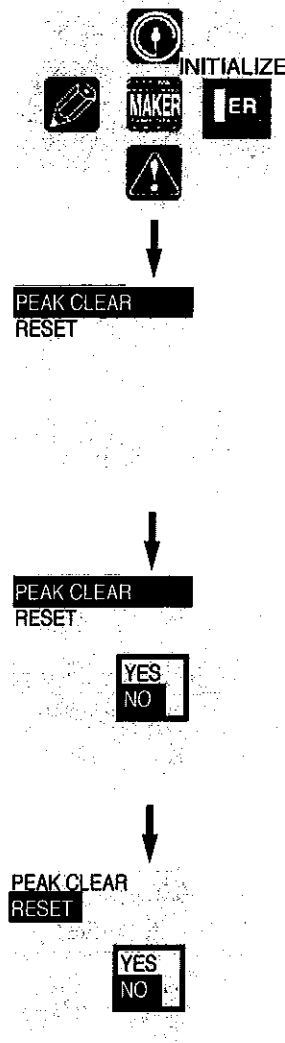

## COLOR INSERT SHEET

### [ How to install the color insert sheet ]

- Remove the clear cover by removing the four small screws with a small flat head screw driver as show in the illustration below.
- Match the screw holes of the color insert sheet with the clear cover and trace the edge with a sharp pencil.
- Cut the color sheet out by cutting along the traced line with a scissors or cutter.
- Place the cut color sheet between the main unit and the clear cover.
- Secure the clear cover and color insert sheet with the four small screws.

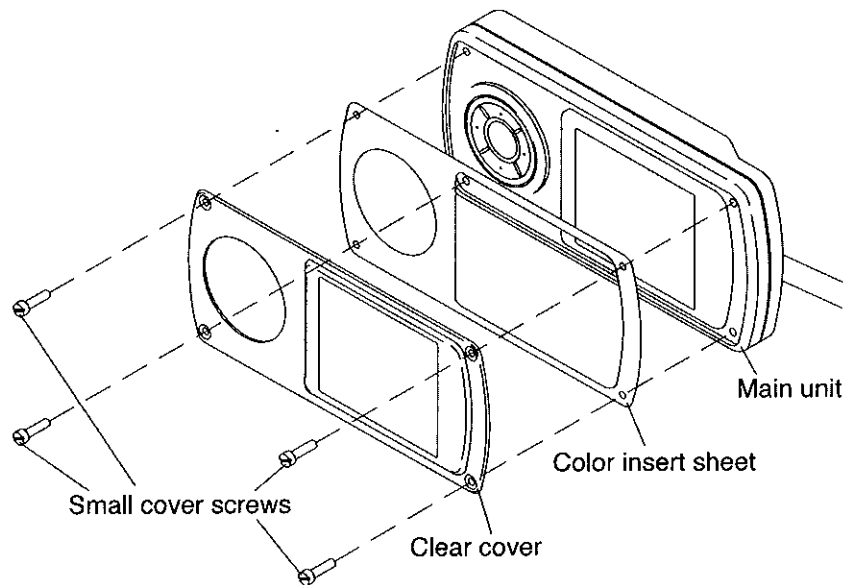

### ⚠ Caution

- When using scissors or cutter, please be careful not to cut your self.