

GREDDY FV BLOW OFF VALVE

Instruction

Please read the manual carefully before installing and using this product.

This product is for off road use only.

PARTS

- | | | | |
|-----------------------------|----|--------------------|----|
| 1. BLOW OFF VALVE | ×1 | 5. GASKET | ×1 |
| 2. VACUUM HOSE 4.5φ | ×1 | 6. BOLT·WASHER·NUT | ×2 |
| 3. THREE WAY FITTING 4-4-4φ | ×1 | | |
| 4. THREE WAY FITTING 6-4-6φ | ×1 | | |

PARTS

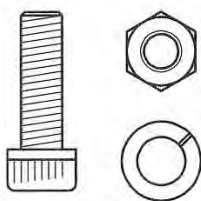
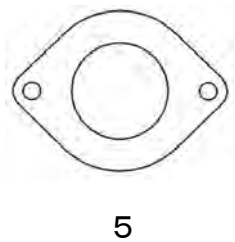
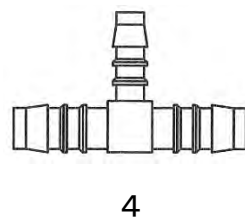
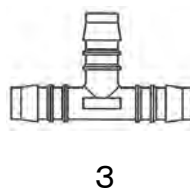
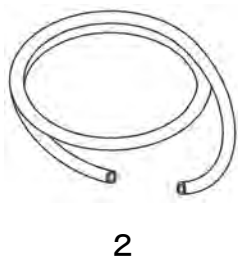
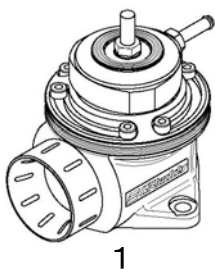

SAFETY

Importa

- This Manual will explain the proper installation procedure of this product.
Please read this manual carefully.
- This manual was created considering the vehicle to be completely factory spec.
- While using this product, please keep this manual to use as a reference.
- The notation shown below is used through out this manual.



Caution

This notation will indicate the important procedures and instructions to prevent accidents and injury.



Warning

This notation will indicate the important procedures and instructions to prevent life treating accidents and injury.

To install this product, the GReddy blow off valve mounting flange is required.
In addition, please prepare other necessary parts such as piping and hoses.

Product Name	Description	Code
Mounting Flange	Aluminum	11900451

- ◆ Install the blow off valve between the intercooler and throttle valve.
- ◆ If sub injectors are used make sure to mount he injectors after the blow off valve between the blow off valve and the throttle body.
- ◆ On some applications, there are possibilities of engine stall if the air is released out to the atmosphere.

It is recommended to re-circulate the sir back in to intake system before the turbo in-let

To re-circulate the air, replacement of the discharge funnel with optional re-circulation hose adapter is required. .

※ **Please prepare necessary part for installation.**

Product Name	Description	Code
Re-circulation Adapter	19 ϕ	11900515
	29 ϕ	11900516
	32 ϕ	11900517
	34 ϕ	11900518



Caution

DO NOT disassemble or mishandle this product.

This will cause the product failure and may damage the engine.

Importa

1. **This product is for off road use only.**
 - This product is legal for sale or use in CA only on vehicles, which may never be driven on a public highway. Check your state and local laws regarding the use of any performance products.
2. **Installation of this product should be performed by an experienced mechanic.**
 - Special tools and modification skills are necessary for the installation of this product.
3. **Inspect the vehicle before the installation of this product.**
 - Inspect the vehicle and make sure that there are no problems with the vehicle before installation.
4. **Do not use this product for purpose other what is intended for.**
 - Damage due to modifications or misuse of this product will void any warranty.

Importa

1. **Disconnect the negative terminal of the battery before installation**
2. **Make sure the engine room has cooled down before installation.**
3. **Removal and disassemble caution**

Please follow the basic manufacturer's recommended

- Make sure to clean the parts that are reused and replace any parts that are damaged.
4. **Installation and reassembly caution**
 - Clean the parts thoroughly before installing the parts.
 - Make sure to replace gaskets with new part.
 - Please refer to the torque spec chart for the proper torque specs for the bolts and nuts.

Jacking and lifting precautions



Caution

- When Jacking up the front or rear of the vehicle, please make sure to lift the vehicle up at the proper jack points and use safety stands and Wheel chocks.
- When Lifting the vehicle, ensure that the front and rear of the vehicle are well balanced at the proper lift points.

Importa



Caution Make sure to check the installation before operating the vehicle.



Caution Before starting the engine, make sure that there are no flammable items around the exhaust system and in the engine room.



Warning Start the engine in a well-ventilated area.

Although we have taken all the possible measures to provide the highest quality products, we will not be responsible for any damage, or accidents caused by improper use, incorrect installation.

GReddy Performance Products, Inc.

Installatio

- (1) Install the blow off valve to the mounting flange (sold separately) using the provided gasket and hardware.
- (2) Connect the vacuum nipple on the top housing to the intake manifold pressure source. Use the three way fitting if necessary.

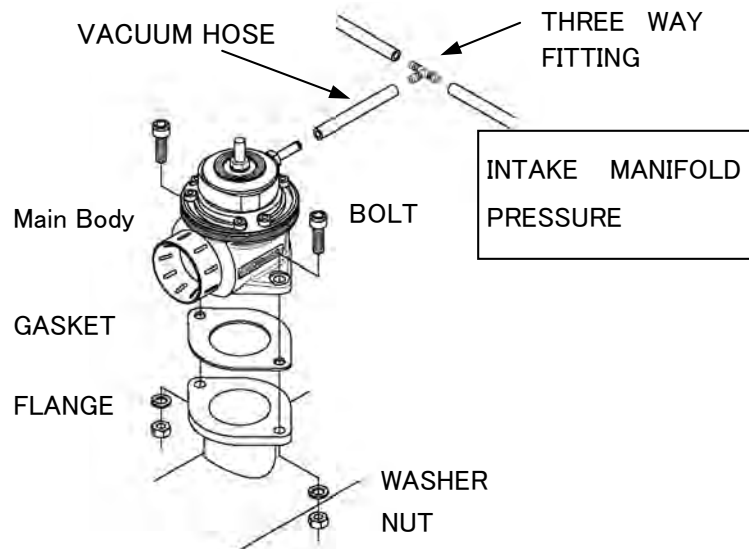

Top Hat Positioning

- (1) Loosen the M6 lock nut and screw on top of the Top Hat relieve tension on the internal springs to make adjustments in Top Hat positioning.
- (2) To rotate the Top Hat, loosen all M4 screws marked A & B one full rotation.
- (3) Remove the screws labeled A to rotate the Top Hat to the Right.
Remove the screws labeled B to rotate the Top Hat to the Left.
※Be sure to only remove screws A or B, removing both may cause the Top Hat to come off.

- (4) Adjust the hose fitting to the desired location.
※When adjusting to the desired location, gently rotate the top hat so the internal diaphragm is not compromised.
- (5) Adjustments can be made up to 90° in both directions. If more rotation is needed, then the removal of both screw sets A & B is required.

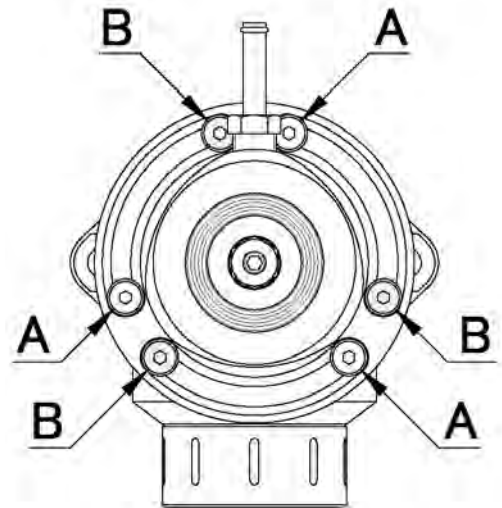

- (6) Once the desired setting is acquired, replace the M4 screws and tighten them to the suggested torque specs $N \cdot m (kgf \cdot m)$ 1.2(0.12)
- (7) When Top Hat adjustment is complete, reset the M6 screw and lock nut to the desired setting.

Starting the

- (1) Inspect the installation. Reconnect the negative terminal of the battery and start the engine.
- (2) Check and make sure that there no air leaks, clearance problems or irregular sound.
- (3) Lightly rev up the engine couple times to check if the blow off valve is operating.

Adjustment after

If irregular idle or engine stall occurs, loosen the M6 lock nut and turn the adjustment screw to **HARD** until the problem is eliminated.

After the adjustment, tighten the lock nut to secure the setting.

- ※ The adjustment is preset to the softest position form factory. Do not turn it further out that this position.
- ※ Make sure to loosen the lock nut before making adjustment. Turning the adjusting screw without loosening the lock nut will strip out the top housing.
- ※ When the adjustment screw is turned in, the stock of the valve decreases. Screwing it in too far will affect the proper operation of the valve.

When venting the outlet to the atmosphere, depending on the application, the airflow meter voltage can drop enough to stall the vehicle when the blow off valve is discharged.

If adjustment of the top screw cannot prevent the engine stall, install e-Manage system and use the Anti Engine Stall feature or reroute the discharge outlet back into the intake system after the airflow meter.



Warning If the engine stalls while operating the vehicle, the steering and the Brakes will not operate properly and can be very dangerous.