

GoPro



HERO 7

BLACK



Contents

Meet Your HERO7 Black	6
Setting Up Your Camera	8
Getting to Know Your GoPro	13
Using QuikCapture	22
Adding HiLight Tags	56
Recording Video	25
Video Settings	29
Taking Photos	32
Photo Settings	36
Capturing Time Lapse	38
Time Lapse Settings	39
Live Streaming	41
Capturing the Action	42
Exposure Control	44
Connecting to an External Microphone	47
Controlling Your GoPro with Your Voice	48
Playing Back Your Media	52
Using Your Camera with an HDTV	56
Connecting to Other Devices	58
Transferring Your Media	60

Contents

Customizing Your GoPro	65
Important Messages	71
Resetting Your Camera	73
Mounting Your GoPro	75
Removing the Side Door	81
Maintenance	83
Battery Information	84
Troubleshooting	87
Tech Specs: Video	88
Tech Specs: Photo	102
Tech Specs: Time Lapse	107
Tech Specs: Protune	112

Meet Your HERO7 Black

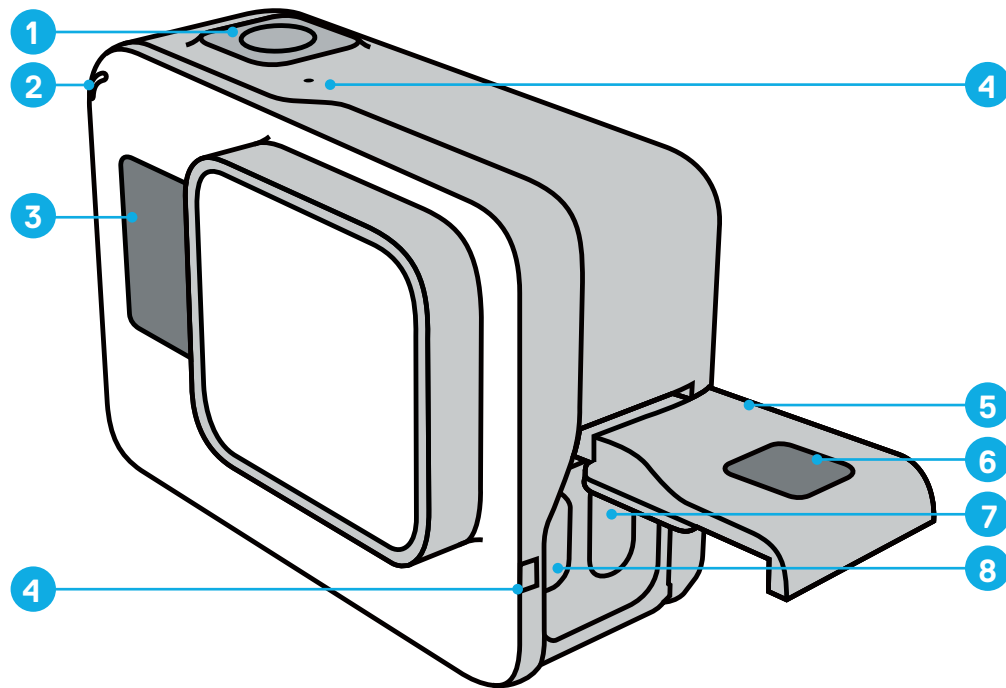

- 1. Shutter Button 
- 2. Status Light
- 3. Status Screen
- 4. Microphone
- 5. Side Door

- 6. Latch Release Button
- 7. USB-C Port
- 8. Micro HDMI Port
(cable not included)
- 9. Touch Screen

Meet Your HERO7 Black

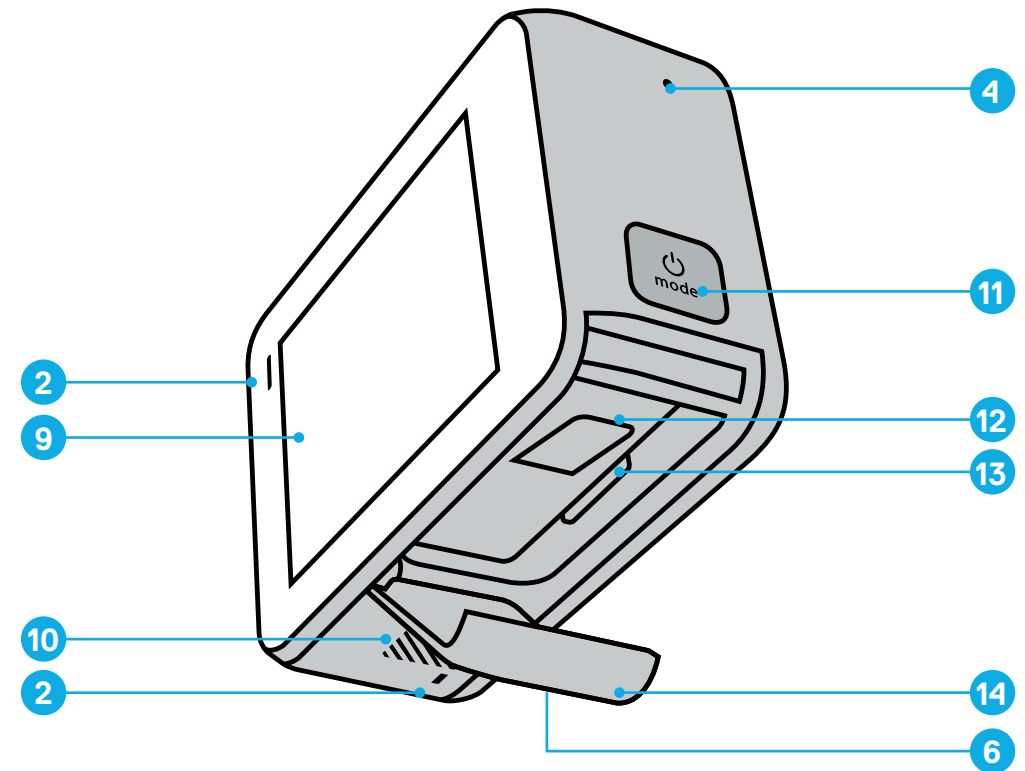

- 10. Speaker
- 11. Mode Button 
- 12. Battery
- 13. microSD Card Slot
- 14. Battery Door

Learn how to use the accessories that came with your GoPro. See [Mounting Your GoPro](#) (page 75).

Setting Up Your Camera

MICROSD CARDS

You'll need a microSD™ card (sold separately) to save your videos and photos. Use a brand name card that fits these requirements:

- microSD, microSDHC™, or microSDXC™
- Class 10 or UHS-I rating
- Capacity up to 256GB

Heads Up: Be sure your hands are clean and dry before handling your SD card. Check the manufacturer's guidelines to see your card's acceptable temperature range and other important information.

PRO TIP: Keep your SD card in good condition by reformatting it regularly. This will erase all of your media, so be sure to save it first.

1. Swipe down to access the Dashboard.
2. Tap Preferences > Reset > Format SD Card.

To learn how to save your videos and photos, see [Transferring Your Media](#) (page 60).

Setting Up Your Camera

INSTALLING YOUR MICROSD CARD

1. Hold down the Latch Release button on the battery door, then slide the door open.

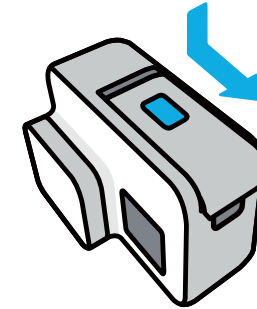

2. With your camera off, insert the SD card into the card slot with the label facing the battery compartment.

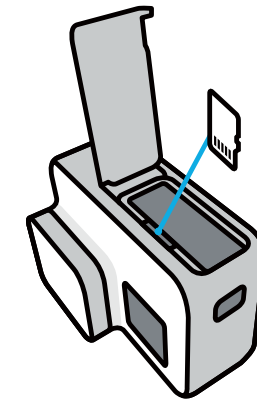

You can eject the card by pressing it into the slot with your fingernail.

Setting Up Your Camera

INSTALLING + CHARGING THE BATTERY

Make sure your battery is fully charged before heading out.

1. Hold down the Latch Release button on the battery door, then slide the door open.

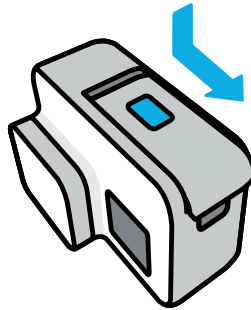

2. Insert the battery, then close the door.

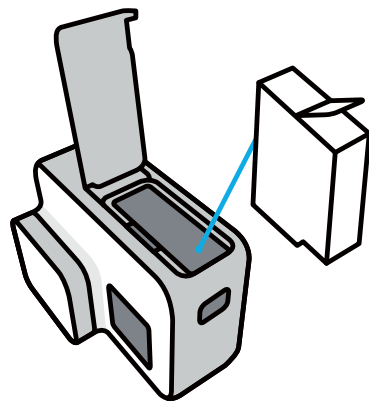

Setting Up Your Camera

3. Open the side door and connect your camera to a USB charger or computer using the included USB-C cable.

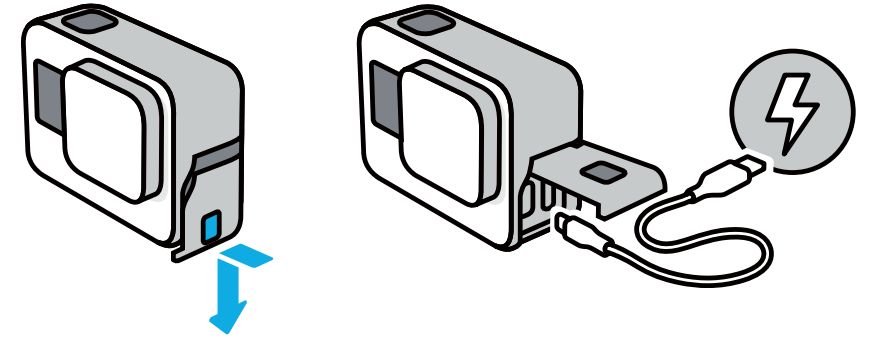

It takes about 2 hours for the battery to fully charge. The camera status light will turn off when it's done. To learn more, see [Battery Information](#) (page 84).

PRO TIP: For the fastest charging, use the GoPro Supercharger (sold separately).

Setting Up Your Camera

UPDATING YOUR CAMERA'S SOFTWARE

To get the latest features and best performance from your GoPro, make sure it's using the most current software.

Updating With the GoPro App

1. Download the app from the Apple® App Store® or Google Play™.
2. Follow the app's on-screen instructions to connect your camera to your mobile device. If new camera software is available, the app will tell you how to install it.

Updating With the Quik Desktop App

1. Download the app from **gopro**.
2. Connect your camera to your computer using the included USB-C cable. If new camera software is available, the app will tell you how to install it.

Updating Manually

1. Visit **gopro**.
2. Choose *HERO7 Black* from the list of cameras.
3. Select *Update your camera manually* and follow the instructions.

PRO TIP: Want to know what software version you're using? Here's where you can find out.

1. Swipe down to access the Dashboard.
2. Tap Preferences > About > Camera Info.

Getting to Know Your GoPro

POWERING ON

Press the Mode button  to turn on your HERO7 Black.

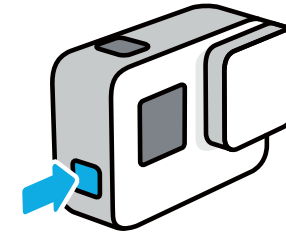

POWERING OFF

Press and hold the Mode button  to turn it off.

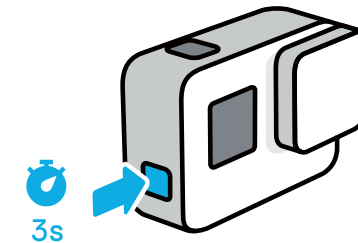

WARNING: Use caution when using your GoPro and related mounts and accessories. Always be aware of your surroundings to avoid injuring yourself and others.

Be sure to follow all local laws including all privacy laws, which may restrict recording in certain areas.

Getting to Know Your GoPro

CAPTURE MODES

Your GoPro has three main capture modes.

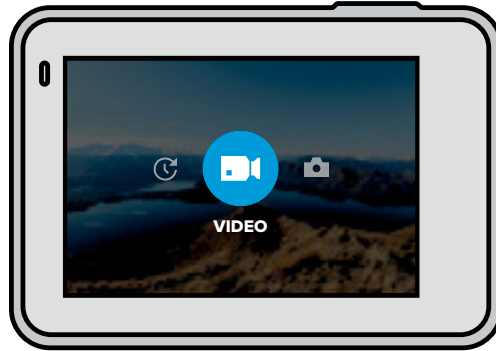

Change modes by swiping left or right to the one you want.

Video

Includes Video and Looping video.

To learn more, see [Recording Video](#) (page 25).

Photo

Includes Photo, Burst, and Night.

To learn more, see [Taking Photos](#) (page 32).

Time Lapse

Includes TimeWarp Video, Time Lapse Video, Time Lapse Photo, and Night Lapse Photo. To learn more, see [Capturing Time Lapse](#) (page 38).

PRO TIP: With the camera on, you can press the Mode button  to switch modes.

Getting to Know Your GoPro

CAMERA ORIENTATION

Your GoPro can easily switch between landscape and portrait shots. It also captures videos and photos right-side up even if it's mounted upside down. The touch screen menu will automatically adjust and your media will play back right-side up.

The orientation is locked in when you press the Shutter button . If your camera tilts during recording, like on a roller coaster, your footage will tilt with it. You'll capture every twist and turn.

Landscape Lock

This locks your camera into landscape orientation. Your on-screen camera menu won't change if you rotate your camera to portrait orientation.

1. Swipe down to access the Dashboard.
2. Tap Preferences > Touch Screen > Landscape Lock.

Heads Up: Videos and photos shot in portrait orientation with Landscape Lock on will play back sideways.

PRO TIP: Use Landscape Lock to keep from accidentally starting a video in portrait orientation. It's perfect when you're using body and handheld mounts.

Getting to Know Your GoPro

CAPTURE MODES

This screen gives you total access to your camera's capture settings and provides information about your GoPro. The settings shown vary by mode.



1. Current Mode (Video, Photo, or Time Lapse)
2. Recording Time/Photos Remaining
3. Short Clips
4. Capture Mode
5. Capture Settings
6. Battery Status
7. Touch Zoom

Heads Up: The settings menu is not available when you turn your GoPro to take portrait shots. Adjust those settings before rotating your camera.

Getting to Know Your GoPro

USING THE TOUCH SCREEN

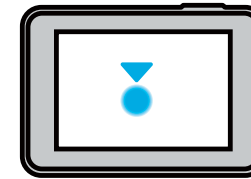

Tap
Selects an item, turns a setting on or off.

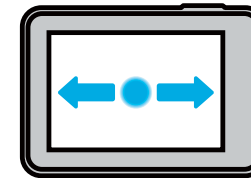

Swipe Left or Right
Switches between Video, Photo, and Time Lapse modes.

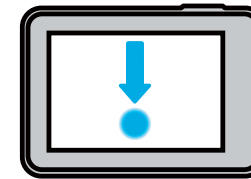

Swipe Down From the Edge of the Screen
Open the Dashboard when your camera is in a landscape orientation.

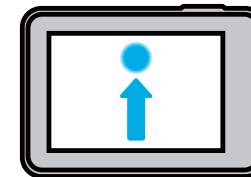

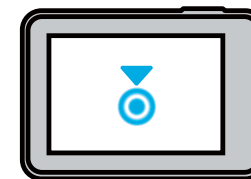

Swipe Up From the Edge of the Screen
See your videos and photos in the Media Gallery.



Press and Hold
Turn on and adjust Exposure Control.

Getting to Know Your GoPro

USING THE SHUTTER BUTTON

1. Press the Shutter button  to start recording.
2. Press the Shutter button  again to stop recording (Video, Time Lapse, and Live Streaming only).

CHANGING MODES + SETTINGS

1. Swipe left or right to the mode you want.



2. Tap the capture mode icon to see all available capture modes.



Getting to Know Your GoPro

3. Choose a capture mode from the list.

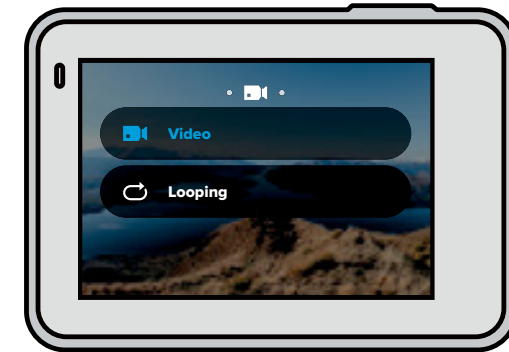

4. Tap the settings if you want to change the resolution or make other adjustments.



Getting to Know Your GoPro

5. Tap the setting you want to change.

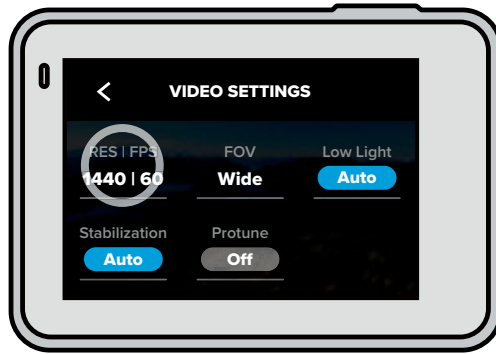

Your choices will appear in white. Options that are not compatible with other settings you've chosen will be in gray.

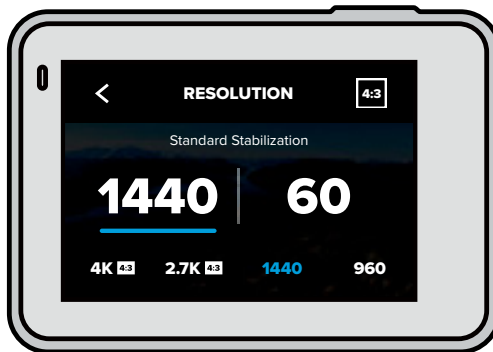



Heads Up: The settings menu is not available when you turn your GoPro for portrait shots. Adjust the settings before rotating your camera.

Getting to Know Your GoPro

NAVIGATING WITH THE BUTTONS

Though your GoPro is waterproof, the touch screen won't work under water. Use the buttons and front screen to change modes and settings.

1. With your camera on, hold down the Mode button  and press the Shutter button . A menu will appear on the front screen.
2. Press the Mode button to scroll through the modes and settings.
3. Use the Shutter button to select and adjust settings.
To exit: Press and hold the Shutter button or scroll until you reach Done, then press the Shutter button.

Heads Up: The Dashboard and Media Gallery are not available when navigating with the buttons.

Using QuikCapture

QuikCapture is the fastest and easiest way to power on your GoPro and get the shot. All it takes is the push of a single button.

RECORDING VIDEO WITH QUIKCAPTURE

1. With your camera off, press the Shutter button .

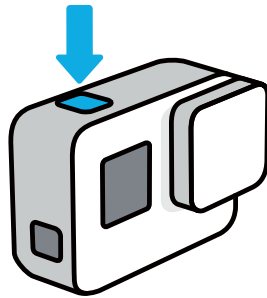

2. Press the Shutter button  again to stop recording and turn off your camera.

Heads Up: When using QuikCapture, your camera will start recording with the settings that you used last.

For more Video options, see [Recording Video](#) (page 25).

Using QuikCapture

TAKING TIME LAPSE PHOTOS WITH QUIKCAPTURE

1. With your camera off, press and hold the Shutter button  until your camera turns on (about 3 seconds).

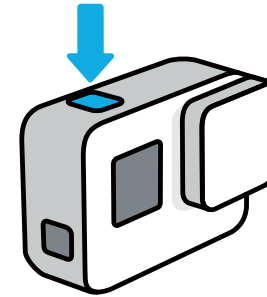

2. Press the Shutter button  again to stop Time Lapse and turn off your camera.

For more Time Lapse options, see [Capturing Time Lapse](#) (page 38).



TURNING QUIKCAPTURE OFF

QuikCapture is on by default, but you can turn it off.

1. Swipe down to access the Dashboard.
2. Tap .

PRO TIP: Since it only turns the camera on when it's recording, QuikCapture is a great way to maximize battery life.

Adding HiLight Tags

Mark favorite moments in your videos and photos by pressing the Mode button  during recording or playback. This adds a HiLight Tag  that makes those moments easier to find when you're watching your footage, creating a video, or looking for a certain shot.

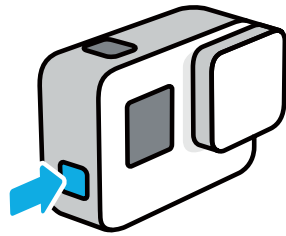

You can also add HiLight Tags using the GoPro app or saying “GoPro HiLight” when Voice Control is on.

PRO TIP: QuikStories looks for HiLight Tags when it creates videos. This helps ensure that favorite moments are included in your stories.

Recording Video

Your GoPro has two Video capture modes: Video and Looping. Each has its own settings.



VIDEO

This mode shoots traditional video in resolutions up to 4K. The default settings are 1440p60 video with a 4:3 aspect ratio and Wide field of view, with Video Stabilization and Auto Low Light both set to Auto.

LOOPING VIDEO

Looping lets you record continuously, but only save the moments you want. Use it when you're waiting for something to happen (like fishing) or when nothing may happen (like a dashcam).

Here's how it works:

- If you select 5-minute intervals, only the previous 5 minutes are saved when you press the Shutter button  to stop recording.
- If you record for 5 minutes and don't press the Shutter button , your camera will loop back and record over the start of the video.

The default settings for Looping are 1440p60 video with a 4:3 aspect ratio and Wide field of view with a 5 minute duration.

To learn more, see [Looping Interval](#) (page 101).

Recording Video

RECORDING SHORT CLIPS

HERO7 Black can shoot short video clips that are quick and easy to save on your phone and share on social media. They're also perfect for creating QuikStories with the GoPro app.

1. From the Video screen, tap .



2. Choose to record a 15 or 30 second clip.



Recording Video

3. Press the Shutter button  to start recording. A border will start circling your screen to show you how much time is left in your clip.



Your camera will automatically stop recording at the end of the clip. You can also stop recording by pressing the Shutter button  before the clip is finished.

Recording Video

USING TOUCH ZOOM

Touch Zoom helps you capture a closer view of the action.

1. From the Video screen, tap .



2. Use the slider to choose how much you want to zoom.



3. Tap anywhere to exit. The zoom level is locked until you re-adjust it, switch capture modes, or turn off your camera.

PRO TIP: You can set up your shot using any combination of Clip, Zoom and settings you want.

Video Settings

Tap the settings to adjust the video resolution, frame rate, and more.



RES | FPS

Resolutions (RES) are grouped by aspect ratio. Tap the aspect ratio in the upper right corner of the RES | FPS screen to toggle between tall 4:3 (great for selfies and point-of-view shots) or widescreen 16:9 (great for cinematic shots).

Choose your resolution and frames per second (fps). Use higher frame rates to capture fast action or create slo-mo videos. All of the frame rates for the resolution you selected are shown in white. Unavailable settings are in gray.

To learn more, see:

- [Video Resolution \(RES\)](#) (page 88)
- [Frames per Second \(FPS\)](#) (page 91)
- [Aspect Ratio](#) (page 92)

Video Settings

FOV (VIDEO)

Choose your field of view (FOV)—SuperView, Wide, or Linear. Scroll through the options on the right side of the FOV screen to see a live preview of each option, then tap the one that you want.

Heads Up: Available fields of view will vary based on the resolution and frame rate you select.

To learn more, see [Field of View \(Video\)](#) (page 93).

LOW LIGHT

Your GoPro uses Auto Low Light to automatically adjust to darker settings when you're shooting video at 50 or 60 frames per second. It's set to Auto by default, but can be turned off here.

To learn more, see [Auto Low Light](#) (page 101).

STABILIZATION

Perfect for biking, skating, skiing, handheld shots, and more, HyperSmooth video stabilization delivers insanely smooth gimbal-like footage without the gimbal. Stabilization is set to Auto by default.

Your GoPro will let you know whether it will use HyperSmooth stabilization, standard stabilization, or shoot unstabilized footage when you choose your resolution and frame rate.

To learn more, see [Video Stabilization](#) (page 97).

Video Settings

PROTUNE

Turn on Protune to take manual control of Color, ISO Limit, Exposure, microphone settings, and more.

To learn more, see [Protune](#) (page 112).

INTERVAL (LOOPING)

Choose how long your GoPro records before looping back to record over the start of the video.

To learn more, see [Looping Interval](#) (page 101).

Taking Photos

Your GoPro has three Photo capture modes: Photo, Burst, and Night. All photos are captured at 12MP. Each mode has its own settings.

PHOTO

Use this mode to capture a single photo or a series of continuous photos. A single press of the Shutter button  will capture a single photo.

Press and hold the Shutter button  to take continuous photos at a rate of 3 or 30 per second (depending on lighting conditions). The default field of view for Photos is Wide with SuperPhoto turned off.

BURST

Burst captures photos at blistering rates of up to 30 per second. This makes it great for action shots. The default field of view for Burst is Wide with a rate of 30 photos in 1 second.

NIGHT

In Night mode your camera's shutter stays open longer to let in more light. It's perfect for dim or dark scenes, but not recommended for handheld or mounted shots when the camera is moving. The default field of view for Night is Wide with the Shutter set to Auto.

Taking Photos

SETTING UP THE PHOTO TIMER

Use the Timer to set up a selfie, group shot, and more.

1. From the Photo screen, tap .



2. Choose 3 seconds (great for selfies) or 10 seconds (great for group shots).



Taking Photos

3. Press the Shutter button . Your camera will start the countdown. It will also beep and the front status light will blink. Both will speed up as the time winds down before snapping the photo.



Heads Up: To help prevent blurry low-light shots, the timer is automatically set to 3 seconds when you switch to Night photo mode.

Taking Photos

USING TOUCH ZOOM

Touch Zoom helps you capture a closer view of the action.

1. From the Photo screen, tap .



2. Use the slider to choose how much you want to zoom.



3. Tap anywhere to exit. The zoom level is locked until you re-adjust it, switch capture modes, or turn off your camera.

PRO TIP: You can set up your shot using any combination of Burst, Photo Timer and Zoom you want.

Photo Settings

Tap the settings to adjust the field of view, turn SuperPhoto on, and more.



FOV

Choose your field of view (FOV)—Wide or Linear. Scroll through them on the right side of the FOV screen to see a live preview of each, then tap the one you want.

To learn more, see [Field of View \(Photo\)](#) (page 105).

SUPERPHOTO

SuperPhoto automatically uses advanced image processing to give you the most brilliant photos possible in any lighting, but it may take longer to process each shot. SuperPhoto is off by default. Select Auto to turn it on or choose HDR On to use High Dynamic Range processing in every shot.

To learn more, see [SuperPhoto](#) (page 102).

RAW

Turn on to save your photos as both .jpg and .gpr files. To learn more, see [RAW Format](#) (page 105).

Photo Settings

PROTUNE

Manually control the settings in all three Photo capture modes—Photo, Burst, and Night.

To learn more, see [Protune](#) (page 112).

RATE (BURST)

Choose how many photos your camera will take in a 1, 2, 3, or 6 second burst.

To learn more, see [Burst Rate](#) (page 104).

SHUTTER (NIGHT)

Set how long your camera's shutter stays open for night shots. Choose longer exposures for darker shots.

To learn more, see [Shutter Speed](#) (page 104).

Capturing Time Lapse

Your GoPro has four Time Lapse capture modes: TimeWarp Video, Time Lapse Video, Time Lapse Photo, and Night Lapse Photo. Each mode has its own settings.

TIMEWARP VIDEO

HERO7 Black lets you speed up time by capturing super stabilized time lapse video while you're on the move. This makes it perfect for mountain bike runs, hikes, and more. The default settings are 1440p video with a 4:3 aspect ratio and Wide field of view at 10x speed.

TIME LAPSE VIDEO

Time Lapse Video lets you turn long events into short shareable videos. It's great for sunsets, street scenes, and more when your camera is still. The default settings are 1440p video with a 4:3 aspect ratio, Wide field of view, and 0.5-second interval.

TIME LAPSE PHOTO

Time Lapse Photo lets you focus on your activity instead of on your camera. It takes a continuous series of photos that you can look through to find the best shots later. The default settings are 0.5-second intervals with a Wide field of view.

NIGHT LAPSE PHOTO

Night Lapse Photo was made for capturing a series of photos in dark environments. The shutter stays open longer to let in more light. The default shutter speed and interval are set to Auto with the field of view set to Wide.

Time Lapse Settings

Tap the settings to adjust the video resolution, field of view, and more.



RESOLUTION (TIMEWARP + TIME LAPSE VIDEO)

Select the video resolution (RES) and aspect ratio for your shot. The higher the resolution, the more detail you'll get in your footage.

To learn more, see [Video Resolution \(TimeWarp + Time Lapse Video\)](#) (page 108).

SPEED (TIMEWARP VIDEO)

Set your video speed. Choose a lower speed (2x or 5x) for short activities or higher speeds (10x, 15x or 30x) for longer activities.

To learn more, see [TimeWarp Video Speed](#) (page 107).

FOV

All TimeWarp and Time Lapse videos are captured with a Wide field of view. Time Lapse and Night Lapse photos can be captured in either a Wide or Linear FOV.

To learn more, see [Field of View \(Photo\)](#) (page 105).

Time Lapse Settings

INTERVAL (TIME LAPSE VIDEO + TIME LAPSE PHOTO)

Choose how often your camera captures a frame of video or takes a photo. Use shorter intervals for quick activities and longer intervals for extended activities.

To learn more, see [Time Lapse Interval](#) (page 109).

SHUTTER (NIGHT LAPSE PHOTO)

Set how long your camera's shutter stays open for night shots. Choose longer exposures for darker shots.

To learn more, see [Shutter Speed](#) (page 104).

INTERVAL (NIGHT LAPSE PHOTO)

Set how often your camera takes a photo in low and ultra low light scenes. Choose short intervals for scenes with a lot of movement and more light. Use longer intervals in scenes with little or no movement or light.

To learn more, see [Night Lapse Photo Interval](#) (page 111).

RAW (TIME LAPSE + NIGHT LAPSE PHOTO)

Turn on to save your photos as both .jpg and .gpr files.

To learn more, see [RAW Format](#) (page 105).



PROTUNE (TIME LAPSE PHOTO + NIGHT LAPSE PHOTO)

Manually control the settings when shooting time lapse and night lapse photos.

To learn more, see [Protune](#) (page 112).

Live Streaming

SETTING UP A LIVE STREAM

1. Connect to the GoPro app. For details, see [Connecting to the GoPro App](#) (page 58).
2. In the app, tap  to control your camera.
3. Tap  and follow the instructions to set up your stream.

Capturing the Action

Here are some of the best modes and settings for capturing your favorite activities. Try them out, then experiment to find what works best for you.

Activity	Video	Photo
Car mounted	<ul style="list-style-type: none"> • 1440p60, Wide FOV • 4K60, Wide FOV • 5x TimeWarp Video 	Photo or Continuous Photo, Wide FOV
Family/travel	<ul style="list-style-type: none"> • 1440p60, Wide FOV • 4K60, Wide FOV • 10x TimeWarp Video 	Photo or Continuous Photo, Wide FOV
Cycling, mountain biking	<ul style="list-style-type: none"> • 1440p60, Wide FOV • 2.7K60 4:3, Wide FOV • 15x TimeWarp Video 	Time Lapse Photo (10-second interval), Wide FOV
Hiking	<ul style="list-style-type: none"> • 1440p60, Wide FOV • 4K30 4:3, Wide FOV • 15x TimeWarp Video 	Photo, Wide FOV
Motorcycle, motocross	<ul style="list-style-type: none"> • 1440p60, Wide FOV • 2.7K60 4:3, Wide FOV • 15x TimeWarp Video 	Time Lapse Photo (5-second interval), Wide FOV

Capturing the Action

Activity	Video	Photo
Skiing, snowboarding (non-POV*)	<ul style="list-style-type: none"> • 1080p120, Wide FOV • 4K60, Wide FOV • 15x TimeWarp Video 	Time Lapse Photo (1-second interval), Wide FOV, or Burst (30/3 Rate), Wide FOV
Skiing, snowboarding (POV*)	<ul style="list-style-type: none"> • 1440p60, Wide FOV • 1440p120, Wide FOV • 15x TimeWarp Video 	Time Lapse Photo (2-second interval), Wide FOV, or Burst (30/3 Rate), Wide FOV
Surfing	<ul style="list-style-type: none"> • 1080p240, Wide FOV 	Time Lapse Photo (5-second interval), Wide FOV, or Burst (30/6 Rate), Wide FOV
Underwater activities	<ul style="list-style-type: none"> • 1440p60, Wide FOV • 4K60, Wide FOV 	Time Lapse Photo (2-second interval), Wide FOV
Water activities	<ul style="list-style-type: none"> • 1440p60, Wide FOV • 1080p240, Wide FOV 	Time Lapse Photo (5-second interval), Wide FOV

*Point-of-view (POV) shots are those taken from your point of view. Non-POV shots are those taken from a different perspective (like when your GoPro is mounted on a ski pole or surfboard).

Exposure Control

HERO7 Black scans the entire scene to choose the exposure level for your shot. Exposure Control lets you decide if only a section of the shot should be used to set the exposure.

Check out the shot preview on your touch screen. Try Exposure Control if there are sections that are too dark or too light.

SETTING EXPOSURE CONTROL USING AUTO EXPOSURE

With this option, the camera automatically bases exposure on the area that you select.

Imagine your camera is mounted on your dashboard. You probably want to set the exposure based on the scene outside the car instead of the dashboard. This will help prevent your shots from being overexposed (too bright).

1. Press the touch screen until a set of brackets with a dot in the middle appears in the center of the screen. This is the Spot Meter. It will base the exposure on the center of the shot.
2. Drag the brackets away from the center if you want to use another area of the shot to set the exposure. (You can also tap that area instead of dragging the brackets.)
3. Check the screen to see if the exposure looks good. Tap  in the lower right corner.

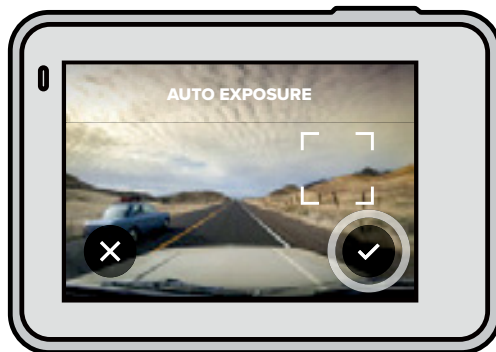

Exposure Control

SETTING EXPOSURE CONTROL USING LOCKED EXPOSURE

With this option, your camera locks the exposure until you cancel it.

If you're snowboarding on a sunny day, you might try locking the exposure on your subject's jacket. This will help prevent your shots from being underexposed (too dark) compared to the bright snow.

1. Press the touch screen until a set of brackets with a dot in the middle appears in the center of the screen. This is the Spot Meter. It will base the exposure on the center of the shot.
2. Drag the brackets away from the center if you want to use another area of the shot to set the exposure. (You can also tap that area instead of dragging the brackets.)
3. Tap inside the brackets to lock the exposure.
4. Check the screen to see if the exposure looks good. Tap  in the lower right corner to lock it in.

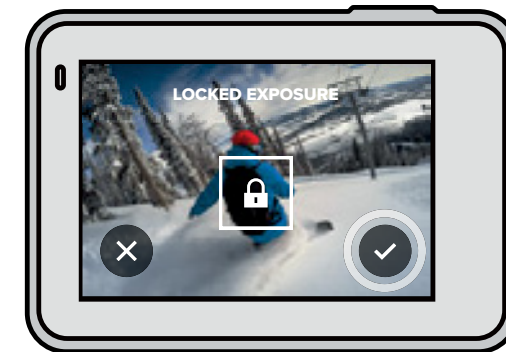

Exposure Control

Turning Exposure Control Off

Exposure Control is automatically turned off when you switch capture modes or restart your camera. It can also be turned off manually.

1. Press the touch screen until a square appears in the middle.
2. Tap  in the lower left corner.

Heads Up: After canceling Exposure Control, your camera will go back to automatically using the entire scene to set the exposure level.

Connecting to an External Microphone

You can use an external microphone to enhance the audio in your videos.

1. Connect the microphone to your camera's USB-C port using the GoPro Pro 3.5mm Mic Adapter (sold separately).
2. From your camera's main screen, swipe down to access the Dashboard.
3. Tap Preferences > Input/Output > Audio Input.
4. Tap an option.

Option	Description
Standard Mic (default)	Supports non-powered mics
Standard Mic+	Supports non-powered mics and provides 20dB boost
Powered Mic	Supports self-powered mics
Powered Mic+	Supports self-powered mics and provides 20dB boost
Line In	Supports line-level output from other audio equipment (mixing board, guitar preamplifier, karaoke machine, etc.)

Heads Up: If you're not sure which option to select, check the information that came with your microphone.

Controlling Your GoPro With Your Voice

Voice Control gives you easy hands-free control of your GoPro. It's great when you're busy with handlebars, ski poles, and more. Just tell your GoPro what you want it to do.

TURNING VOICE CONTROL ON + OFF

1. Swipe down to access the Dashboard.
2. Tap  to turn Voice Control on or off.

Controlling Your GoPro With Your Voice

LIST OF VOICE COMMANDS

There are two types of voice commands—Action commands and Mode commands.

Using Action Commands

These commands let you switch modes on the fly. If you just recorded a video, you can say “GoPro take a photo” to snap a photo without manually switching modes.

Action Command	Description
GoPro start recording	Starts recording video
GoPro HiLight	Adds a HiLight Tag to your video during recording
That was sick	Adds a HiLight Tag to your video during recording
GoPro stop recording	Stops recording video
GoPro take a photo	Takes a single photo
GoPro shoot burst	Takes burst photos
GoPro start time lapse	Starts taking time lapse photos
GoPro stop time lapse	Stops taking time lapse photos
GoPro turn on	Turns your camera on (Wake on Voice must be on)
GoPro turn off	Turns your camera off

Controlling Your GoPro With Your Voice

Using Mode Commands

Use these commands to switch capture modes on the go. Then say, “GoPro Capture” or press the Shutter button to get the shot.



Mode Command	Description
GoPro Video mode	Switches your camera to Video mode (does not start recording)
GoPro Photo mode	Switches your camera to Photo mode (does not take a photo)
GoPro Burst mode	Switches your camera to Burst mode (does not start taking burst photos)
GoPro Time Lapse mode	Switches your camera to Time Lapse Photo mode (does not start taking time lapse photos)
GoPro Capture	Starts capturing videos or photos in the mode you selected
GoPro Stop Capture	Stops capture in Video and Time Lapse mode. Photo and Burst mode stop on their own.

PRO TIP: If you’re recording video or time lapse, you must stop recording before trying a new command.

Controlling Your GoPro With Your Voice

TURNING ON YOUR GOPRO WITH YOUR VOICE

With this setting, your GoPro will turn on and respond to voice commands when it’s off.

1. Swipe down to access the Dashboard.
2. Tap  to turn on Voice Control.
3. Tap Preferences > Voice Control > Wake on Voice.
4. Power off your camera by saying “GoPro turn off” or pressing the Mode button .
5. Turn on your camera by saying “GoPro turn on” or “GoPro start recording.”

Heads Up: Your camera will listen for commands for 8 hours after you’ve turned it off.

SEE A COMPLETE LIST OF COMMANDS ON YOUR CAMERA

1. Swipe down to access the Dashboard.
2. Tap Preferences > Voice Control > Commands.

CHANGING YOUR VOICE CONTROL LANGUAGE

1. Swipe down to access the Dashboard.
2. Tap Preferences > Voice Control > Language.







Heads Up: Voice Control may be affected by wind, noise, and your distance from the camera. Keep your camera clean and wipe away any debris for the best performance.

Playing Back Your Media



Swipe up to see the last video, photo or burst you took. Swipe left and right to flip through the other files on your SD card.



The Media Gallery includes the following playback options:

-  Pause playback
-  Resume playback
-  See all of the media on your SD card
-  Delete the file from your SD card
-  Play back at slo-mo/normal speed
-  Use a slider to scan through your videos, bursts, and time lapse photos
-  Add/remove HiLight Tag

Playing Back Your Media

-  Adjust the playback volume
-  Go to the previous or next photo in a burst or group of continuous photos

Heads Up: The playback options will vary based on the type of media you're viewing.

PRO TIP: Some playback options are not available when you're holding your camera in portrait orientation. Make adjustments to those settings in landscape orientation before rotating your camera.



Playing Back Your Media

USING GALLERY VIEW

Gallery view gives you quick access to all of the videos and photos stored on your SD card.



1. From the playback screen, tap .



2. Swipe up to scroll through your media.
3. Tap a video or photo to see it in full-screen view.
4. Tap  to add a HiLight Tag.
5. Tap  to go back to the playback screen.

Heads Up: Gallery view is not available when you're holding your camera in portrait orientation. Also, the more content you have on your SD card, the longer it will take to load.

Deleting Multiple Files

1. Tap .
2. Tap all of the files that you want to delete. Tap a file again if you want to de-select it.
3. Tap  to delete the selected files.

Playing Back Your Media

VIEWING VIDEOS + PHOTOS ON A MOBILE DEVICE

1. Connect your camera to the GoPro app. For details, see [Connecting to the GoPro App](#) (page 58).
2. Use the controls on the app to play back, edit, and share your videos and photos.

PRO TIP: Use the GoPro app to grab still photos from videos, create short shareable videos from full-length footage, save media to your phone, and more.







VIEWING VIDEOS + PHOTOS ON A COMPUTER

To see your media on a computer, you must first save the files to the computer. To learn more, see [Transferring Your Media to a Computer](#) (page 61).

Using Your Camera With an HDTV

SEE YOUR VIDEOS + PHOTOS ON AN HDTV

Put them up on the big screen for everyone to see.

1. From the camera's main screen, swipe down to access the Dashboard.
2. Tap Preferences > Input/Output > HDMI Output > Media.
3. Use a micro HDMI cable (sold separately) to connect your camera to an HDTV or monitor.
4. Select the HDMI input on the TV.
5. Press the Mode button  on your camera to move through the controls, then press the Shutter button  to select the control.
For example, use the Mode button  to go through the thumbnails until you get to , then use the Shutter button  tap .
6. To open a file in full-screen view, tap .

PRO TIP: You can also play back your media by inserting your SD card directly into a compatible TV.

Using Your Camera With an HDTV

CAPTURING VIDEO + PHOTOS WHILE CONNECTED TO AN HDTV

This option lets you see the live preview from your camera when it's connected to an HDTV or monitor.

1. From the camera's main screen, swipe down to access the Dashboard.
2. Tap Preferences > Input/Output > HDMI Output, then choose one of these options:
 - Tap Monitor to see your camera's live preview with the icons and camera info that you usually see on the touch screen.
 - Tap Live to see the live preview without the icons and camera info.
3. Use a micro HDMI cable (sold separately) to connect your camera to an HDTV or monitor.
4. Select the HDMI input on the TV.
5. Use the Shutter button  on the camera to start and stop recording.

Connecting to Other Devices

CONNECTING TO THE GOPRO APP

Use the GoPro mobile app to control your HERO7 Black, share videos and photos on the go and automatically transform your footage into QuikStories—awesome videos synced with effects and music.

Connecting for the First Time

1. Download the GoPro app from the Apple® App Store® or Google Play™.
2. Follow the app's on-screen instructions to connect your camera.

Heads Up for iOS®: When prompted, be sure to allow notifications from the GoPro app so you know when a QuikStory is ready.

To learn more, see [Creating a QuikStory](#) (page 60).

After the First Time

After you've connected once, you can start connecting through your camera's Connections menu.

1. If your camera's wireless is not already on, swipe down to access the Dashboard.
2. Tap Preferences > Connections > Connect Device.
3. Follow the on-screen instructions in the GoPro app to connect.

Connecting to Other Devices

CONNECTING TO BLUETOOTH DEVICES

You can connect your GoPro to Bluetooth devices that capture data about your footage. The data can be used to enhance your videos with stats about your adventure.

1. Connect your camera to the GoPro app. For details, see [Connecting to the GoPro App](#) (page 58).
2. In the app, open the camera settings, then tap Bluetooth Devices.
3. Follow the on-screen instructions.

SETTING THE CONNECTION SPEED

Your GoPro is set to use the 5GHz Wi-Fi band (the fastest available) when connecting to other mobile devices.

Change the Wi-Fi band to 2.4GHz if your device or region does not support 5GHz.

1. Swipe down to access the Dashboard.
2. Tap Preferences > Connections > Wi-Fi Band.

Transferring Your Media

CREATING A QUIKSTORY

You can set up your GoPro to automatically send videos and photos to your phone. The GoPro app will use them to create QuikStories—fully edited videos complete with music and effects.

1. Connect your camera to the GoPro app. For details, see [Connecting to the GoPro App](#) (page 58).
2. Swipe down on the app's home screen. Shots from your most recent session will be copied to your phone and transformed into a QuikStory.
3. Tap your QuikStory to view it. If you don't have the Quik app, you'll be prompted to install it.
4. Make any edits you'd like in the Quik app.
5. Save the QuikStory or share it with your friends, family, and followers.

Finding the Best Shots

Be sure to mark your best shots with HiLight Tags. QuikStories looks for tags when it creates videos. This helps ensure that favorite moments are included in your stories.

HERO7 Black also knows when you face the camera, smile, and more. It automatically tags these shots with data so QuikStories can handpick them for your videos.

To learn more, see [Adding HiLight Tags](#) (page 56).

Transferring Your Media

TRANSFERRING YOUR MEDIA TO A COMPUTER

You can copy your videos and photos to a computer for playback and editing.

Using the Quik Desktop App

1. Be sure that your computer is running the latest version of its operating system.
2. Download and install the Quik desktop app from **gopro**.
3. Connect your camera to your computer using the included USB-C cable.
4. Power on your camera and follow the on-screen instructions in the Quik app.

Transferring Directly From Your SD Card

1. Remove the SD card from your camera.
2. Insert the card into an SD card reader or adapter.
3. Plug the card reader into your computer's USB port or insert the adapter into the SD card slot.
4. Copy the files to your computer.

Transferring Your Media

AUTO UPLOADING TO THE CLOUD

With a GoPro Plus subscription, you can automatically upload your media to the cloud where you can view, edit, and share it from any device.

1. Subscribe to GoPro Plus:
 - a. Download the GoPro app to your device from the Apple App Store or Google Play.
 - b. Follow the app's on-screen instructions to connect your camera.
 - c. If you're connecting for the first time, follow the on-screen instructions to subscribe to GoPro Plus. Otherwise, tap  on the camera chooser screen.
2. Connect your camera to a power outlet. Auto Upload will start when the battery is fully charged.

After first-time setup, your camera won't need to connect to the app to start Auto Upload.

Heads Up: Your original files remain on your camera even after they've been backed up to the cloud.

PRO TIP: If you're saving files to your computer, the Quik desktop app will automatically upload them to your GoPro Plus account.

Transferring Your Media

MANUALLY UPLOADING TO THE CLOUD

Transfer your media to the cloud without waiting for your camera to fully charge. (Your GoPro must still be connected to a power outlet.)

1. Subscribe to GoPro Plus.
2. Connect your camera to a power outlet.
3. Swipe down to access the Dashboard.
4. Tap Preferences > Manual Upload.

ACCESSING YOUR CLOUD MEDIA

1. Open the GoPro app on your device.
2. Tap , and select Cloud to view, edit, and share your content.

PRO TIP: Create a QuikStory with your cloud media. Open the Quik app, tap , then select GoPro Plus.

Transferring Your Media

TURNING OFF AUTO UPLOAD

You can keep your camera from trying to upload every time it's connected to a power outlet and fully charged.

1. Swipe down to access the Dashboard.
2. Tap Preferences > GoPro Plus > Auto Upload > Upload.
3. Tap Off.

CONNECTING TO A DIFFERENT WIRELESS NETWORK

1. Swipe down to access the Dashboard.
2. Tap Preferences > GoPro Plus > Networks.
3. Choose a network. The network can't be hidden or require an end-user license agreement (for example, a network in a hotel).
4. Enter the password if needed.
5. Tap  to save the network.

CHANGING YOUR GOPRO PLUS PREFERENCES

Manage your Auto Upload settings, set up your wireless network, and more.

1. Swipe down to access the Dashboard.
2. Tap Preferences > GoPro Plus.

Heads Up: GoPro Plus will be available in your Preferences after you've signed up.

Customizing Your GoPro





USING THE DASHBOARD

With your camera in landscape orientation, swipe down to access the Dashboard and Preferences.



DASHBOARD FEATURES

The Dashboard lets you quickly tap the following settings on and off:

-  Voice Control
-  Camera Beeps
-  QuikCapture
-  Screen Lock

Customizing Your GoPro



CONNECTION STATUS

Check the top of the Dashboard to see your connection status.



GPS is on (white)

GPS is off (gray)

GPS is unavailable (gray)



Camera is connected to the GoPro app (white)

Camera is not paired to the GoPro app (gray)

Camera is not connected to the GoPro app (gray)



Auto Upload is on and ready (white)

Auto Upload is off (gray)

Auto Upload is on, but not ready (gray)

Customizing Your GoPro

CHANGING PREFERENCES

Preferences let you set up your GoPro any way you want.



CONNECTIONS

Turn on wireless connections, connect new devices, set the Wi-Fi band, and more. To learn more, see [Connecting to the GoPro App](#) (page 58) and [Setting the Connection Speed](#) (page 59).



GENERAL

Here's everything you'll find under General settings:

Beep Volume

Choose High (default), Med, Low, or Off. The volume you set here can be toggled on or off using the Dashboard.

Default Mode

Set the mode your GoPro captures in when you turn it on using the Mode button . This setting does not affect QuikCapture.

Auto Power Off

Choose 5 Min, 15 Min (default), 30 Min, or Never.

Customizing Your GoPro

LEDs

Set which status lights blink. Choose All On (default), All Off, or Front Off.

Time and Date

Use to manually adjust the time and date. Both are automatically updated when you connect your camera to the GoPro app or Quik desktop app.

Date Format

This is set automatically based on the language that you chose at setup. You can also change it manually here.

Video Compression

Set the file format for your videos. Choose HEVC (to reduce file sizes) or H.264 + HEVC (to use H.264 to maximize compatibility with older devices while using HEVC for advanced settings).



VOICE CONTROL

Activate Wake on Voice, choose your Voice Control language and see a full list of commands.



TOUCH SCREEN

Turn on Landscape Lock, set the Screen Saver, and adjust the touch screen's brightness.

Heads Up: The camera buttons and Voice Control still work even when the screen is off.

Customizing Your GoPro



REGIONAL

Turn on GPS and set up your GoPro to work in your region.

GPS

Turn on GPS to track your speed, distance, and more. Add performance stickers in the GoPro app to show how fast, far, and high you were going in your videos.

Language

Choose the language that appears on the camera.

Video Format

Choose NTSC for North America or PAL if you're outside North America. The right format for your region will help prevent flicker on a TV/HDTV when you play back video that was recorded indoors.

Regulatory

See all of your GoPro's certifications.



ABOUT

Update your GoPro, plus find your camera's name, serial number, and software version.

Customizing Your GoPro



INPUT/OUTPUT

Set up how you want to use your camera's HDMI output and find the right setting for your external microphone.



RESET

Format your SD card, reset your camera's default settings, reset the camera tips, or use Factory reset to clear your camera and restore its original settings.

Important Messages

Problems are rare, but HERO7 Black will let you know if anything comes up. Here are some of the messages you might see.



HIGH TEMPERATURE

The Temperature icon appears on the touch screen if your camera becomes too hot and needs to cool down. Your camera was designed to recognize when it's at risk of overheating and will shut down when needed. Simply let it sit and cool before using it again.

Heads Up: High temperatures will cause your camera to use more power and drain the battery faster.

PRO TIP: Shooting video at a high resolution and frame rate will also cause your camera to heat up faster, especially in hot environments. Try switching to a lower resolution and frame rate to lower the risk of overheating.

Important Messages



FILE REPAIR

HERO7 Black will automatically try to fix damaged files. Files can be damaged if your camera loses power while recording or if there's a problem saving the file. The File Repair icon will appear on the touch screen when a repair is in progress. Your camera will let you know when it's finished and if the file was fixed.

MEMORY CARD FULL

Your camera will let you know when your SD card is full. You'll need to move or delete some files if you want to keep recording.

Resetting Your Camera

RESTARTING YOUR GOPRO

If your camera is not responding, press and hold the Mode button  for 10 seconds. This will restart your camera. There will be no changes to your settings.

RESTORE ALL SETTINGS TO THE DEFAULTS

This will reset all of your camera settings to the defaults, except your camera name and password, Language, and Video Format.

1. Swipe down to access the Dashboard.
2. Tap Preferences > Reset > Reset Defaults.

RESETTING CONNECTIONS

This will clear your device connections and reset your camera's password. Resetting connections means you'll have to reconnect all of your devices.

1. Swipe down to access the Dashboard.
2. Tap Preferences > Connections > Reset Connections.

RESETTING THE CAMERA TIPS

Want to see the camera tips again? Here's how to see them all from the beginning.

1. Swipe down to access the Dashboard.
2. Tap Preferences > Reset > Reset Camera Tips.

Resetting Your Camera

RESTORING FACTORY SETTINGS

This will restore all of your camera's original settings, clear all device connections, and deregister your camera from GoPro Plus. This is useful if you're giving your camera to a friend and want to completely reset it to its original state.

1. Swipe down to access the Dashboard.
2. Tap Preferences > Reset > Factory Reset.

Heads Up: Restoring the factory settings will not delete any content from your SD card or have any effect on your camera's software.

Mounting Your GoPro

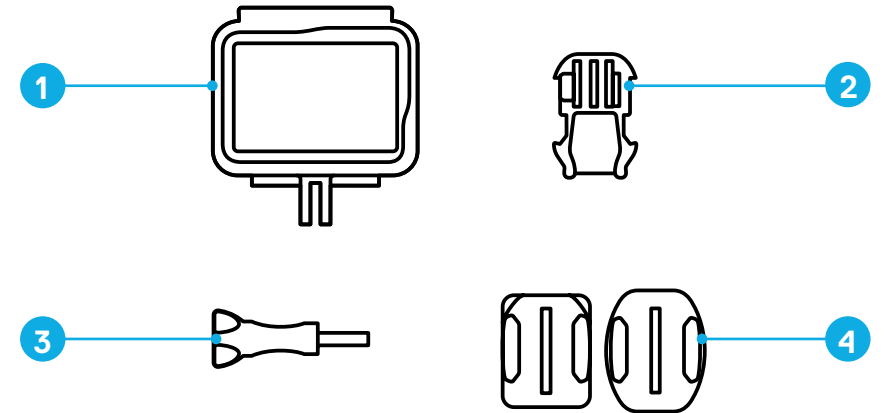

MOUNTING HARDWARE

1. The Frame
2. Mounting Buckle
3. Thumb Screw
4. Curved + Flat Adhesive Mounts

Mounting Your GoPro

USING THE FRAME

The Frame is used to attach your camera to GoPro mounts.

1. Unlock the latch and open the door.
2. Slide your camera in. Be sure that your camera sits flush against the front edge of The Frame.
3. Close the door.
4. Lock the latch.

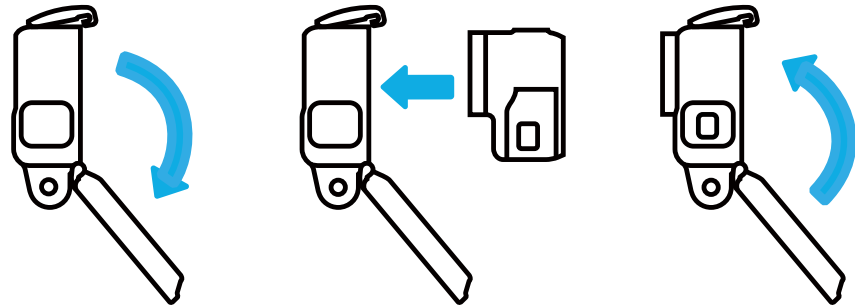

Mounting Your GoPro

ATTACHING YOUR CAMERA TO MOUNTS

Once your camera's in The Frame, you're ready to mount. Depending on the mount you're using, you'll either use a mounting buckle or attach The Frame directly to the mount itself.

See [Mounting Tips](#) (page 79) for tips on using adhesive mounts.

1. Interlock the mounting fingers on The Frame with the mounting fingers on the buckle.
2. Secure The Frame to the mounting buckle with a thumb screw.

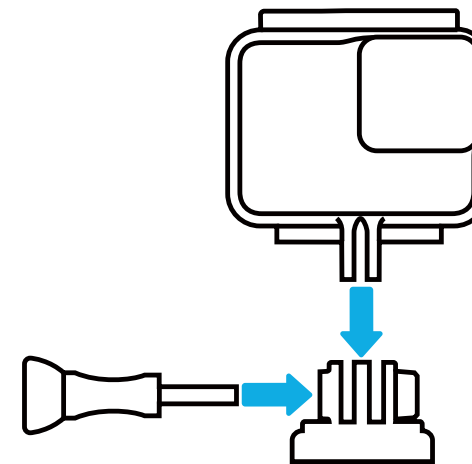

Mounting Your GoPro

3. Attach the mounting buckle to the mount.
 - a. Flip up the mounting buckle plug.
 - b. Slide the buckle into the mount until it clicks into place.
 - c. Press the plug back down so that it sits flush with the buckle.

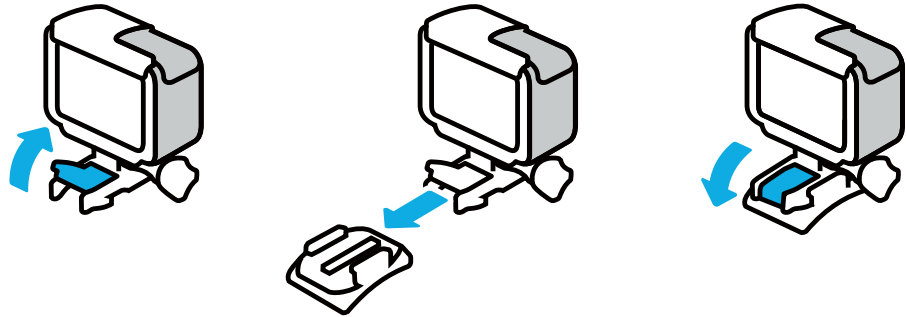

PRO TIP: You may want to keep your camera in The Frame, even when it's not mounted. The Frame gives your camera a little extra protection in case you drop it.

Mounting Your GoPro

MOUNTING TIPS

Follow these guidelines when attaching adhesive mounts to helmets, vehicles, and gear:

- Attach mounts at least 24 hours before you use them.
- Only attach the mounts to smooth surfaces. They won't stick properly to porous or textured surfaces.
- Firmly press mounts into place. Be sure the adhesive is in full contact with the surface.
- Only use on clean, dry surfaces. Wax, oil, dirt, or other debris will weaken the bond and you could lose your camera.
- Attach mounts in room temperature conditions. They won't stick properly in cold or damp environments or on cold or damp surfaces.
- Check state and local regulations and laws to ensure that attaching a camera to equipment (such as hunting equipment) is permitted. Always comply with regulations that restrict the use of consumer electronics or cameras.



WARNING: To avoid injury, do not use a tether when mounting your camera on a helmet. Do not mount the camera directly on skis or snowboards.

Mounting Your GoPro

WARNING: Always use a helmet that meets applicable safety standards if you're using a GoPro helmet mount or strap.



Choose the right helmet for your sport or activity, and make sure that it's the right size and fit for you. Check to see that your helmet's in good condition, and always follow the manufacturer's instructions on safe use.

Replace any helmet that's had a major impact. No helmet can protect against injury in every accident. Be safe.

USING YOUR GOPRO IN + AROUND WATER

HERO7 Black is waterproof to 33ft (10m) with the door closed. You won't need an additional housing before diving in.

The touch screen was designed to work when wet, but you may need to wipe it off if it has trouble sensing your commands. You can also navigate with your camera's buttons if you're under water. To learn more, see [Navigating with the Buttons](#) (page 21).

Heads Up: The Frame does not provide additional waterproof protection.

PRO TIP: Use a camera tether and a Floaty (sold separately) to keep your camera afloat in case it detaches from the mount.

To capture extreme adventures down to 196ft (60m), pick up the GoPro Super Suit (Protection + Dive Housing), sold separately.

Removing the Side Door

There might be times when you need to remove your camera's door. This can include when you want to charge it while it's in The Frame.



WARNING: Only remove the door in a dry, dust-free environment. The camera is not waterproof when the door is open or removed.

REMOVING THE SIDE DOOR

1. Hold down the Latch Release button and slide the door open.
2. Pull the door off.

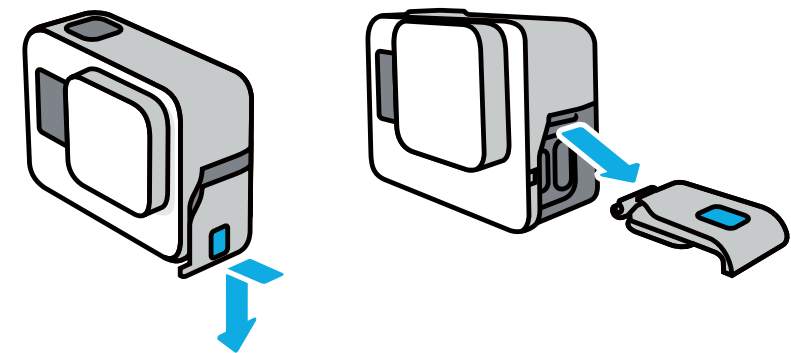

Removing the Side Door

REATTACHING THE SIDE DOOR

1. Hold down the Latch Release button and extend the tab on the door.
2. Press the tab onto the small silver bar.

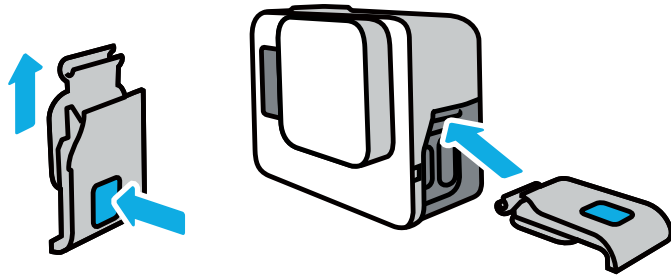

Maintenance

Follow these tips to get the best performance from your camera:

- Your GoPro is waterproof to 33ft (10m)—no housing needed. Be sure the door is closed before using it in or around water, dirt, or sand.
- Before closing the door, be sure the seal is free of debris. Use a cloth to clean the seal if needed.
- Make sure your GoPro is dry and clean before opening the door. Rinse your camera with fresh water and dry it with a cloth if needed.
- If sand or debris hardens around the door, soak your camera in warm tap water for 15 minutes and then rinse thoroughly to remove the debris before opening the doors.
- For the best audio performance, shake your camera or blow on the mic to remove water and debris from the microphone holes. Do not use compressed air to blow into the mic holes. This could damage the internal waterproof membranes.
- After every use in salt water, rinse your camera with fresh water, and dry it with a soft cloth.
- The lens cover is made from extremely tough strengthened glass, but it can still be scratched or cracked. Keep it clean with a soft, lint-free cloth.
- If debris gets stuck between the lens and trim ring, flush it out with water or air. Do not insert foreign objects around the lens.

Battery Information

MAXIMIZING BATTERY LIFE

A low battery message will appear on the touch screen when the battery charge drops below 10%.

If the charge runs out while recording video, your camera will stop recording, save the video, and turn itself off.

Here are some things you can do to maximize battery life:

- Capture video at lower frame rates and resolutions
- Turn off Protune
- Use the Screensaver and lower the screen Brightness
- Turn off GPS
- Turn off Wireless Connections
- Use these settings:
 - [QuikCapture](#) (page 22)
 - [Auto Power Off](#) (page 67)

RECORDING WHEN PLUGGED INTO A POWER SOURCE

You can use the USB-C cable that came with your camera to shoot videos and photos while your camera is plugged in to a USB-charging adapter, the GoPro Supercharger, another GoPro charger, or the GoPro Portable Power Pack. This is perfect for capturing long videos and time lapse events.

Even though your camera is plugged in, the battery will not charge during recording. It will start charging when you stop recording. You cannot record while charging with a computer.

Heads Up: Because the door is open, your camera is not waterproof when charging.

Battery Information



WARNING: Using a non-GoPro wall charger could damage your camera battery and could lead to fire or leakage. With the exception of the GoPro Supercharger (sold separately), only use chargers marked: Output 5V 1A. If you don't know your charger's voltage and current, use the included USB cable to charge your camera with a computer.

BATTERY STORAGE + HANDLING

HERO7 Black is full of sensitive components, including the battery. Avoid exposing your camera to very hot or cold temperatures. Extreme temperatures may temporarily shorten battery life or cause your camera to temporarily stop working properly. Avoid dramatic temperature or humidity changes, as condensation may form on or within the camera.

Do not dry your camera with an external heat source such as a microwave oven or hair dryer. Damage to the camera or battery caused by contact with liquid inside the camera is not covered under the warranty.

Do not store your battery with metal objects like coins, keys or necklaces. If the battery terminals come in contact with metal objects, this may cause a fire.

Do not make any unauthorized alterations to your camera. Doing so may compromise safety, regulatory compliance, performance, and may void the warranty.

Heads Up: Batteries have reduced capacity in cold weather. This affects older batteries even more. If you regularly shoot at low temperatures, replace batteries yearly for optimal performance.

PRO TIP: Fully charge your camera before storing it away to help maximize battery life.

Battery Information



WARNING: Do not drop, disassemble, open, crush, bend, deform, puncture, shred, microwave, incinerate, or paint your camera or battery. Do not insert foreign objects into any opening on the camera, such as the USB-C port. Do not use your camera if it's been damaged—for example, if cracked, punctured, or harmed by water. Disassembling or puncturing the integrated battery can cause an explosion or fire.

BATTERY DISPOSAL

Most rechargeable lithium-ion batteries are classified as non-hazardous waste and are safe for disposal in the normal municipal waste stream. Many regions' laws that require battery recycling. Check your local laws to make sure that you can dispose of rechargeable batteries in your regular trash. To safely dispose of lithium-ion batteries, protect terminals from exposure to other metal with packing, masking, or electrical tape so they do not cause a fire while being transported.

Lithium-ion batteries, however, do contain recyclable materials and are accepted for recycling by the Rechargeable Battery Recycling Corporation's (RBRC) Battery Recycling Program. We encourage you to visit Call2Recycle at call2recycle.org or call 1-800-BATTERY in North America to find a convenient recycling location.

Never dispose of a battery in a fire because it may explode.



WARNING: Only use GoPro replacement batteries for your camera.

Troubleshooting

MY GOPRO WON'T POWER ON

Make sure your GoPro is charged. See [Charging](#) (page 10). If charging the battery didn't work, try restarting your camera. See [Restarting Your GoPro](#) (page 73).

MY GOPRO WON'T RESPOND WHEN I PRESS A BUTTON

See [Restarting Your GoPro](#) (page 73).

PLAYBACK ON MY COMPUTER IS CHOPPY

Choppy playback is usually not a problem with the file. If your footage skips, one of these issues is probably the cause:

- The computer doesn't work with HEVC files. Try downloading the latest version of the Quik desktop app for free at **gopro**.
- Your computer doesn't meet the minimum requirements of the software you're using for playback.

I FORGOT MY CAMERA'S USERNAME OR PASSWORD

Swipe down to access the Dashboard, then tap Preferences > Connections > Camera Info.

I DON'T KNOW WHAT SOFTWARE VERSION I HAVE

Swipe down to access the Dashboard, then tap Preferences > About > Camera Info.

I CAN'T FIND MY CAMERA'S SERIAL NUMBER

The serial number is stamped inside the battery compartment of your camera. You can also find it by swiping down to access the Dashboard, then tapping Preferences > About > Camera Info.

Tech Specs: Video

VIDEO RESOLUTION (RES)

Video resolution refers to the number of horizontal lines used in each frame of video. A 1080p video is made up of 1080 horizontal lines, each with a width of 1920 pixels. A 4K video is made up of 3840 horizontal lines, each with a width of 2160 pixels. Since more lines equals greater resolution, 4K will deliver a more detailed picture than 1080p.

Video Resolution	Best Use
4K	Our highest resolution video. Great for tripod and fixed-position shots. Can be used to grab 8MP stills from your video.
4K 4:3	Our highest resolution video. The tall 4:3 aspect ratio captures more of the scene than 16:9 shots. Great for point-of-view footage.
2.7K	High resolution 16:9 video that provides stunning, cinema-quality results for professional productions.
2.7K 4:3	Great for high-resolution point-of-view body and gear-mounted shots with fluid slow motion playback.

Tech Specs: Video

Video Resolution	Best Use
1440p	Tall 4:3 aspect ratio fits more into the frame than 1080p. Great for capturing fast action, point-of-view shots and sharing to social media.
1080p	Great for all shots and sharing to social media. High 240 fps and 120 fps options enable super slow motion during editing. Available in all fields of view.
960p	Combines tall 4:3 aspect ratio with 240 fps and 120 fps capture for immersive super slow-motion playback.
720p	Includes 240 fps option for capturing high-frame rate video that can be played back on older devices.

Tech Specs: Video

This chart compares the frame size of each resolution:

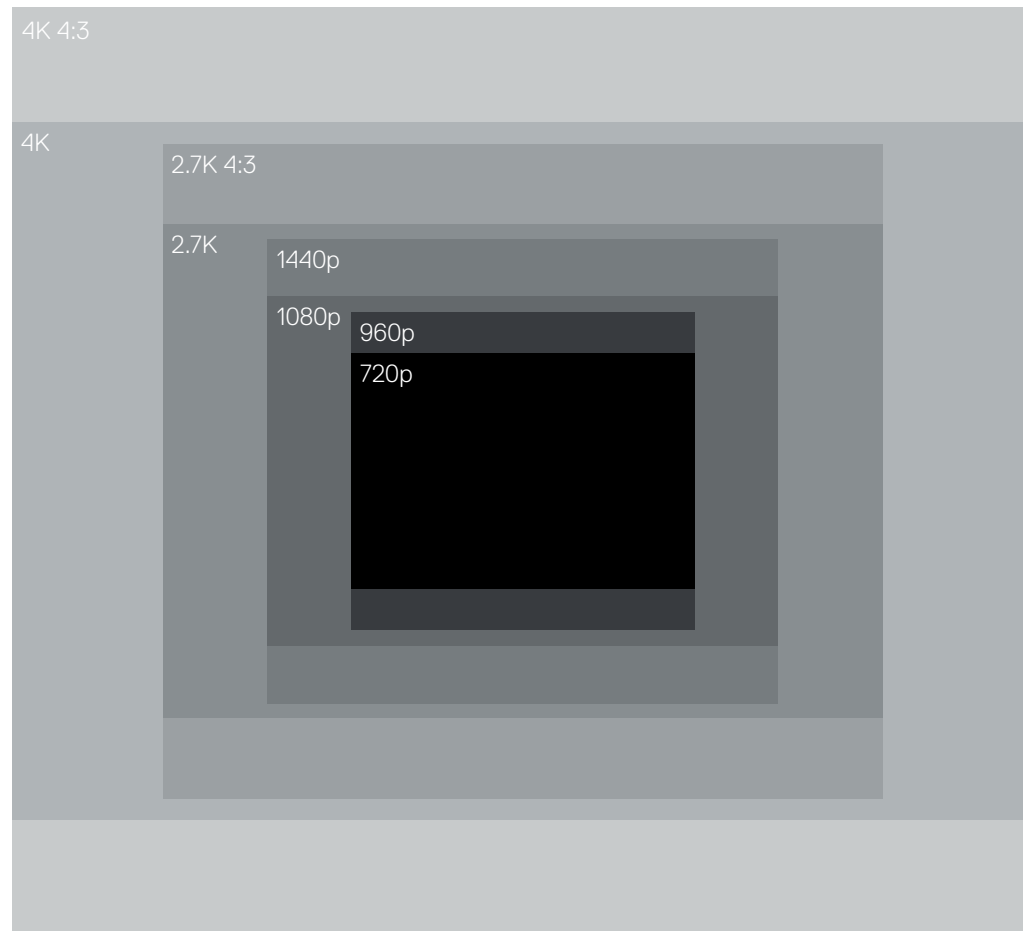

PRO TIP: Be sure that your phone, computer, or TV can support the setting you choose, especially if you're using a high resolution and frame rate.

Tech Specs: Video

FRAMES PER SECOND (FPS)

Frames per second refers to the number of frames captured in each second of video. Higher fps values (60, 120 or 240) are better at capturing fast-action shots. You can also use high fps footage for slow-motion playback.

Resolution + FPS

Higher video resolutions capture more detail and clarity, but they're generally available at lower fps values.

Lower video resolutions capture less detail and clarity, but they can be shot at higher fps values.

When choosing a resolution on the RES | FPS screen, all of the available frame rates for the resolution you selected are shown in white. Unavailable frame rates are in gray.

Tech Specs: Video

ASPECT RATIO

Aspect ratio refers to the width and height of an image. HERO7 Black captures videos and photos in two aspect ratios.

4:3

The tall 4:3 format captures more of the scene than the 16:9 widescreen format. It's great for selfies and point-of-view footage.

16:9

This is the standard format used for HDTV and editing programs. The widescreen format is ideal for capturing dramatic cinematic footage.

Heads Up: Black bars will appear on both sides of the screen when playing back 4:3 footage on an HDTV.

Tech Specs: Video

FIELD OF VIEW (VIDEO)

The field of view refers to how much of the scene is captured by your camera. For Video mode, SuperView captures the most, while Linear captures the least.

FOV	Best Use
SuperView	The world's most immersive field of view, SuperView stretches 4:3 content to fit a 16:9 screen. Great for body- and gear-mounted shots.
Wide (default)	Large field of view that's great for action shots where you want to capture as much as possible within the frame.
Linear	Mid-range field of view that removes the fisheye effect of SuperView and Wide. Perfect for aerial footage and any time you want a more traditional perspective.

Heads Up: Only the fields of view that are compatible with the resolution and frame rate you selected will be available.

Tech Specs: Video

HERO7 BLACK VIDEO SETTINGS

Here's a rundown of your camera's video resolutions along with available fps, FOV, and aspect ratio for each.

Video Resolution (RES)	FPS (NTSC/PAL)*	FOV	Screen Resolution	Aspect Ratio
4K	60/50	Wide	3840x2160	16:9
4K	30/25 24/24	Wide, SuperView	3840x2160	16:9
4K 4:3	30/25 24/24	Wide	4096x3072	4:3
2.7K	120/100	Wide	2704x1520	16:9
2.7K	60/50 30/25 24/24	Linear, Wide, SuperView	2704x1520	16:9
2.7K 4:3	60/50	Wide	2704x2028	4:3
2.7K 4:3	30/25 24/24	Linear, Wide	2704x2028	4:3

Tech Specs: Video

Video Resolution (RES)	FPS (NTSC/PAL)*	FOV	Screen Resolution	Aspect Ratio
1440p	120/100	Wide	1920x1440	4:3
1440p	60/50 30/25 24/24	Linear, Wide	1920x1440	4:3
1080p	240/200	Wide	1920x1080	16:9
1080p	120/100 60/50 30/25 24/24	Linear, Wide, SuperView	1920x1080	16:9
960p	240/200 120/100	Wide	1280x960	4:3
720p	240/200	Wide	1280x720	16:9
720p	60/50	Linear, Wide	1280x720	16:9

*NTSC and PAL refer to the video format, which depends on the region that you're in. To learn more, see [Video Format](#) (page 69).

For suggested settings, see [Capturing the Action](#) (page 42).

Tech Specs: Video



High Resolutions/High Frame Rates

Shooting high-resolution or high-fps video when it's warm out can cause your camera to heat up and use more power.

Lack of airflow and connecting to the GoPro app can cause your camera to warm up even more, use more power, and shorten recording time.

If heat's a problem, try recording shorter videos. Also limit use of features that take a lot of power, like the GoPro app. The GoPro Smart Remote (sold separately) can control your GoPro while using less energy.

Your camera will tell you if it needs to shut down and cool off. To learn more, see [Important Messages](#) (page 71).

Tech Specs: Video

VIDEO STABILIZATION

Your GoPro crops videos by 5% on each side (10% total) during capture. This lets it buffer your footage and help eliminate camera jitters during recording. This is perfect for shooting biking, skating, skiing, handheld shots, and more.

Your camera will tell you which level of stabilization it's using when you set the resolution and frame rate.

Heads Up: Stabilization may be disabled when shooting in extremely cold temperatures (32°F/0°C or lower). The battery's capacity is reduced and may not be able to keep up with these high-performance modes:

Video Resolution (RES)	FPS (NTSC/PAL)*	Aspect Ratio
4K	60/50	16:9
4K	24/24	4:3
2.7K	60/50	4:3

Use a lower resolution or frame rate to capture stabilized video in extremely cold weather.

Tech Specs: Video

HyperSmooth Video Stabilization

HyperSmooth delivers ultra smooth professional footage by accurately predicting your movements and correcting for camera shake.

HyperSmooth is available in the following resolutions and settings:

Video Resolution (RES)	FPS (NTSC/PAL)*	FOV	Screen Resolution	Aspect Ratio
4K	60/50	Wide	3840x2160	16:9
4K	30/25 24/24	Wide, SuperView	3840x2160	16:9
2.7K	60/50 30/25 24/24	Linear, Wide, SuperView	2704x1520	16:9
2.7K	30/25 24/24	Linear, Wide	2704x2028	4:3
1440p	60/50 30/25 24/24	Linear, Wide	1920x1440	4:3
1080p	60/50 30/25 24/24	Linear, Wide, SuperView	1920x1080	16:9
720p	60/50	Linear, Wide	1280x720	16:9

Tech Specs: Video

Standard Video Stabilization

These settings offer standard-level stabilization—the best possible for the following resolutions at higher frame rates:

Video Resolution (RES)	FPS (NTSC/PAL)*	FOV	Screen Resolution	Aspect Ratio
4K	24/24	Wide	3840x2160	4:3
1440p	120/100	Wide	1920x1440	4:3
1080p	120/100	Linear, Wide, SuperView	1920x1080	16:9
960p	120/100	Wide	1280x960	4:3

PRO TIP: You can smooth out your footage even more by using Touch Zoom to crop your shots before you start recording. This will give your camera an even bigger buffer to use when stabilizing your video.

Tech Specs: Video

Unstabilized

The following resolutions and settings cannot be stabilized due to ultra high frame rates and other factors:

Video Resolution (RES)	FPS (NTSC/PAL)*	FOV	Screen Resolution	Aspect Ratio
4K	30/25	Wide	3840x2160	4:3
2.7K	120/100	Wide	2704x1520	16:9
1080p	240/200	Wide	1920x1080	16:9
960p	240/200	Wide	1280x960	4:3
720p	240/200	Linear, Wide	1280x720	16:9

*NTSC and PAL refer to the video format, which depends on the region that you're in. To learn more, see [Video Format](#) (page 69).

TURNING OFF VIDEO STABILIZATION

Video stabilization is on by default, but you can turn it off.

1. From the Video screen, tap the settings.
2. Tap Stabilization.

Tech Specs: Video

AUTO LOW LIGHT

HERO7 Black can tell if there isn't enough light for your shot and automatically lower the frame rate to improve video quality. This is especially helpful when you're moving in and out of low-light conditions.

Auto Low Light is set to Auto by default. It works with all resolutions when shooting at 50 or 60 fps.

Turning Off Auto Low Light

1. From the Video screen, tap the settings.
2. Tap Low Light.

LOOPING INTERVAL

You can set your GoPro to record 5 (default), 20, 60, or 120 minute loops. It can also be set to MAX, which will record until your SD card is full before looping back to record over the start of the video.

Tech Specs: Photo

SUPERPHOTO

SuperPhoto automatically analyzes the scene and intelligently applies the best image processing for the shot.

Depending on the lighting, movement in your shot, and other conditions, SuperPhoto will choose one of four options:

High Dynamic Range (HDR)

Takes and combines multiple photos into a single shot that brings out the details in scenes that mix bright light and shadows.

Local Tone Mapping

Enhances photos by boosting the details and contrast only where it's needed.

Multi-Frame Noise Reduction

Automatically combines multiple shots into a single photo with less digital distortion (noise).

No Additional Processing

Captures photos with no advanced processing when conditions are perfect.

SuperPhoto only works for single photos. Because of the extra time needed to apply image processing, it may take a little longer to process and save each shot.

Heads Up: SuperPhoto does not work with RAW Photo or Protune.

Tech Specs: Photo

Turning SuperPhoto On

SuperPhoto is off by default. Here's how to turn it on.

1. From the Photo screen, tap the settings.
2. Tap SuperPhoto.
3. Select Auto.

Using HDR On

High Dynamic Range (HDR) is one of the image-processing techniques SuperPhoto uses to enhance your shot. You can set your GoPro to use HDR every time you take a photo.

1. From the Photo screen, tap the settings.
2. Tap SuperPhoto
3. Select HDR On.

HDR On can only be used for single photos. For the best results, use it in high-contrast shots with minimal motion.

Heads Up: HDR does not work with RAW Photo or Exposure Control.

Tech Specs: Photo

SHUTTER SPEED (NIGHT + NIGHT LAPSE PHOTO)

Shutter speed lets you decide how long your camera's shutter stays open in Night and Night Lapse Photo modes. Here are your options, plus tips on when to use them:

Speed	Examples
Auto (up to 30 seconds)	Sunrise, sunset, dawn, dusk, twilight, night
2, 5, 10, or 15 seconds	Dawn, dusk, twilight, traffic at night, Ferris wheel, fireworks, light painting
20 seconds	Night sky (with light)
30 seconds	Night stars, Milky Way (complete darkness)

PRO TIP: To reduce blur when using Night and Night Lapse Photo, mount your camera on a tripod or place it on a stable surface where it won't wobble or shake.

BURST RATE

Capture fast-action scenes with one of these high-speed settings:

- Auto (up to 30 photos in 1 second based on lighting conditions)
- 30 photos in 1, 2, 3, or 6 seconds
- 10 photos in 1, 2, or 3 seconds
- 5 photos in 1 second
- 3 photos in 1 second

Tech Specs: Photo

FIELD OF VIEW (PHOTO)

The field of view (FOV) refers to how much of the scene is captured by your camera. HERO7 Black takes photos using two fields of view.

FOV	Description
Wide	Large field of view that's great for action shots where you want to capture as much as possible within the frame.
Linear	Mid-range field of view that removes the fisheye effect of Wide. Perfect for aerial footage and any time you want a more traditional perspective.

RAW FORMAT

When this setting is turned on, all photos are saved as a .jpg image (for viewing on your camera or sharing with the GoPro app) and a .gpr file. The .gpr file is based on the Adobe .dng format. These files can be used in Adobe® Camera Raw (ACR), version 9.7 or later. You can also use Adobe Photoshop® Lightroom® CC (2015.7 release or later) and Adobe Photoshop® Lightroom® 6 (version 6.7 or later).

Tech Specs: Photo

In Photo mode, RAW Format is available for Photo, Night, Time Lapse Photo, and Night Lapse Photo, with these exceptions:

- SuperPhoto must be off.
- FOV must be set to Wide.
- Zoom must be off.
- RAW Format is not available for capturing continuous photos.
- For Time Lapse Photo, the Interval must be at least 5 seconds.
- For Night Lapse Photo, the Shutter setting must be at least 5 seconds.

PRO TIP: Photos in .gpr format are saved in the same location and with the same file name as .jpg files. To access the files, insert your SD card into a card reader and locate them with your computer's file explorer.

Tech Specs: Time Lapse

TIMEWARP VIDEO SPEED

You can increase TimeWarp Video speed up to 30x to turn longer activities into shareable moments.

Use this chart to estimate the length of your videos. For example, recording at 2x speed for 1 minute will give you about 30 seconds of TimeWarp video. Recording at 2x speed for 4 minutes will give you approximately 2 minutes of TimeWarp video.

Speed	Recording Time	Video Length
2x	1 minute	30 seconds
5x	1 minute	10 seconds
10x	5 minutes	30 seconds
15x	5 minutes	20 seconds
30x	5 minutes	10 seconds

Heads Up: Recording times are approximate. The video length may vary depending on the movement in your shot.

Speed	Examples
2x-5x	Driving through a scenic route
10x	Hiking and exploring
15x-30x	Running and mountain biking

PRO TIP: For the best results, try speeds 10x and up when shooting footage that may get bumpy.

Tech Specs: Time Lapse

VIDEO RESOLUTION (TIMEWARP + TIME LAPSE VIDEO)

HERO7 Black shoots TimeWarp and Time Lapse Video in four resolutions. The default settings are 4K with a 16:9 aspect ratio and Wide field of view.

Here are all of your options:

Resolution	Aspect Ratio
4K	16:9
2.7K	4:3
1440p	4:3
1080p	16:9

To learn more, see:

- [Video Resolution \(RES\)](#) (page 88)
- [Aspect Ratio](#) (page 92)

Tech Specs: Time Lapse

TIME LAPSE INTERVAL

The Interval sets how often your camera takes a shot in Time Lapse Video and Time Lapse Photo modes.

Available intervals are 0.5 (default), 1, 2, 5, 10, 30, and 60 seconds.

Interval	Examples
0.5-2 seconds	Surfing, biking, or other sport
2 seconds	Busy street corner
5-10 seconds	Clouds or outdoor scenes for long durations
10-60 seconds	Lengthy activities, such as construction or artwork

Tech Specs: Time Lapse

Time Lapse Video Recording Time

Use this chart to determine the length of your videos. For example, recording for 5 minutes with a 0.5-second interval will give you 20 seconds of time lapse video. Recording for 15 minutes will give you 1 minute of video.

Interval	Recording Time	Video Length
0.5 second	5 minutes	20 seconds
1 second	5 minutes	10 seconds
2 seconds	10 minutes	10 seconds
5 seconds	1 hour	20 seconds
10 seconds	1 hour	10 seconds
30 seconds	5 hours	20 seconds
60 seconds	5 hours	10 seconds

PRO TIP: For the best results, mount your camera on a tripod or place it on a stable surface where it won't wobble or shake. Use TimeWarp Video to capture time lapse video when you're on the move.

To learn more, see [TimeWarp](#) (page 38).

Tech Specs: Time Lapse

NIGHT LAPSE PHOTO INTERVAL

Choose how often your GoPro snaps a shot in Night Lapse Photo mode. Night Lapse intervals are Auto, 4, 5, 10, 15, 20, and 30 seconds, and 1, 2, 5, 30, and 60 minutes.

Auto (default) syncs the Interval with the Shutter setting. If the shutter speed is set to 10 seconds and Interval is set to Auto, your camera captures a photo every 10 seconds.

Interval	Examples
Auto	Great for all exposures (captures as quickly as possible, depending on the Shutter setting)
4-5 seconds	Evening city scene, street lighting, or scenes with movement
10-15 seconds	Dim lighting with slow scene changes, like night clouds with a bright moon
20-30 seconds	Very low light or very slow scene changes, like stars with minimal ambient or street light

Tech Specs: Protune

PROTUNE

Protune unlocks your camera's full creative potential by giving you manual control of Color, White Balance, Shutter Speed, and more. It's compatible with professional color correction tools, the Quik desktop app, and other editing software.

Here are some things to keep in mind:

- Protune is available as an advanced setting for all modes, except Looping, TimeWarp, and Time Lapse Video.
- When Protune is turned on, the settings menu expands to give you full access to all settings. Swipe up to see them all.
- Some Protune settings are not available when you use Exposure Control.
- Changes to Protune settings in one capture mode apply only to that capture mode. For example, changing the White Balance for night photos does not affect White Balance for burst photos.

PRO TIP: You can restore all Protune settings to their defaults through the settings menu.

- If Protune is on, tap settings > Protune Settings.
- If Protune is off, tap settings > Protune > Protune Settings.

Tech Specs: Protune

COLOR

Color lets you adjust the color profile of your videos or photos. Scroll between the options on the right side of the Color screen to see a live preview of each setting, then tap the one you want.

Color Setting	Resulting Color Profile
GoPro Color (default)	Provides GoPro color-corrected profile (same great color as when Protune is turned off).
Flat	Provides neutral color profile that can be color-corrected to better match footage captured with other equipment, offering more flexibility in post-production. Due to its long curve, Flat captures more details in shadows and highlights.

WHITE BALANCE

White Balance lets you adjust the color temperature of videos and photos to optimize for cool or warm lighting conditions. Scroll between the options on the right side of the White Balance screen to see a live preview of each setting, then tap the one you want.

Options for this setting are Auto (default), 2300K, 2800K, 3200K, 4000K, 4500K, 5500K, 6000K, 6500K, and Native. Lower values will give you warmer tones.

You can also choose Native to create a minimally color-corrected file that allows for more precise adjustments in post-production.

Tech Specs: Protune

ISO MINIMUM/MAXIMUM

ISO Minimum and ISO Maximum let you set a range for the camera's sensitivity to light and image noise. Image noise refers to the degree of graininess in the image.

In low light, higher ISO values result in brighter images, but with more image noise. Lower values result in darker images with less image noise. Scroll between the options on the right side of the Color screen to see a live preview of each setting, then tap the one you want.

The default for ISO Maximum is 1600 for video and 3200 for photos. The default for ISO Minimum is 100.

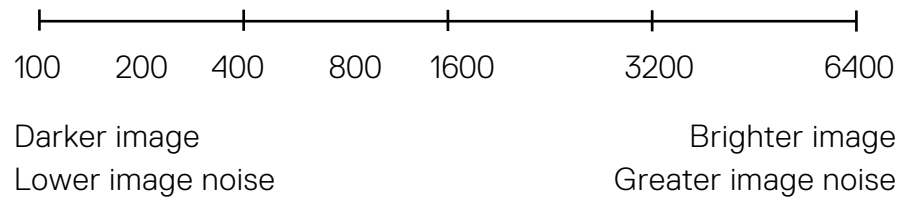

Heads Up: For the Video and Photo modes, ISO behavior depends on the Protune Shutter setting. The ISO Maximum that you select is used as the maximum ISO value. The ISO value that is applied might be lower, depending on the lighting conditions.

PRO TIP: To lock the ISO at a specific value, set ISO Minimum and ISO Maximum to the same values.

Tech Specs: Protune

SHUTTER

The Protune Shutter setting only applies to the Video and Photo modes. This setting determines how long the shutter stays open. Scroll between the options on the right side of the Shutter screen to see a live preview of each setting, then tap the one you want. The default setting is Auto.

For Photo, the options are Auto, 1/125, 1/250, 1/500, 1/1000, and 1/2000 second.

For Video, the options depend on the fps setting, as shown below.

Shutter	Example 1: 1080p30	Example 2: 1080p60
Auto	Auto	Auto
1/fps	1/30 sec	1/60 sec
1/(2xfps)	1/60 sec	1/120 sec
1/(4xfps)	1/120 sec	1/240 sec
1/(8xfps)	1/240 sec	1/480 sec
1/(16xfps)	1/480 sec	1/960 sec

PRO TIP: To reduce the amount of blur in videos and photos when using the Shutter setting, mount your camera on a tripod or other stable surface where it won't wobble or shake

Tech Specs: Protune

EXPOSURE VALUE COMPENSATION (EV COMP)

Exposure Value Compensation affects the brightness of your videos and photos. Adjusting this setting can improve image quality when shooting scenes with sharply contrasting lighting conditions.

Options for this setting range from -2.0 to +2.0. The default setting is 0.

Scroll between the options on the right side of the EV Comp screen to see a live preview of each setting, then tap the one you want. Higher values result in brighter images.

Heads Up: For Video, this setting is available only if Shutter is set to Auto.

You can also adjust the exposure based on a certain area of your scene. To learn more, see [Exposure Control](#) (page 44).

PRO TIP: Exposure Value Compensation adjusts brightness within the existing ISO setting. If brightness has already reached the ISO setting in a low-light environment, increasing the Exposure Value Compensation does not have any effect. To continue increasing the brightness, select a higher ISO value.

Tech Specs: Protune

SHARPNESS

Sharpness controls the quality of details captured in your video footage or photos. Options for this setting are High (default), Medium, and Low.

Scroll between the options on the right side of the Sharpness screen to see a live preview of each setting, then tap the one you want.

PRO TIP: If you plan to increase sharpness during editing, select Low for this setting.

Tech Specs: Protune

RAW AUDIO

This setting creates a separate .wav file for your video, in addition to the standard .mp4 audio track. You can select the level of processing to apply to the RAW audio track.

Option	Description
Off (default)	No separate .wav file is created.
Low	Applies minimal processing. Ideal if you apply audio processing in post-production.
Med	Applies processing based on the Manual Audio Control setting (wind and/or stereo). If Manual Audio Control is turned off, the camera automatically switches between wind filtering and stereo audio.
High	Applies full audio processing (automatic gain, AAC encoding, and manual audio control settings).

Insert your SD card into a card reader to access the .wav files with your computer. They're saved with the same name and in the same location as the .mp4 files.

Tech Specs: Protune

MICROPHONE SETTINGS

Your GoPro uses three microphones to capture sound while recording video. You can customize how they're used based on conditions where you're shooting and the type of sound you want in your finished video.

Option	Description
Auto (default)	Automatically switch between recording in stereo and filtering wind noise to deliver the cleanest audio track possible.
Stereo	Use when wind is not a factor and you want to ensure that your GoPro is recording in stereo.
Wind	Filters out noise on windy days or when your GoPro is mounted on a moving vehicle.