

INSTALLATION INSTRUCTIONS

BRACKET	OVAL SIDE BAR WIDESIDER 4"	WHEEL TO WHEEL WIDESIDER 4"	RUNNING BOARD WIDESIDER 5" & 6"	APPLICATION	MODEL
684429	64429 67429	-	39087	TOYOTA TACOMA DOUBLE CAB.	05 - 12

Parts List:				Tools required not including:	
Item	Qty	Description	Max Torque	Description	Qty
1	2	391884AB		Ratchet	1
2	4	391884BB		12mm Socket	1
				13mm Socket	1
				5" Extension ratchet	1
				15mm. Wrench	
		1 KTE-392895 Hardware Kit:	-		
3	12	5/16x15/16" Black Square head bolt	-		
4	12	5/16" Black Nut	11 Lb/Ft		
5	12	5/16" Black Flat Washer	-		
6	12	5/16" Black Lock Washer	-		
7	12	M8x25 Zinc Plate hex head bolt	11 Lb/Ft		
8	12	5/16" Zinc plate flat washer	-		
9	12	5/16" Zinc plate Lock washer	-		
		NOTE: 64429-67429 (B-PS) INCLUDES:			
10	1	Oval 4" Widesider bar set	-		

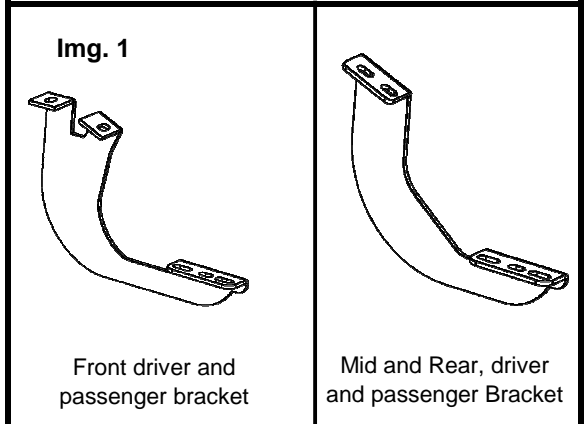

Instructions: Approximated installation time: 30 min.

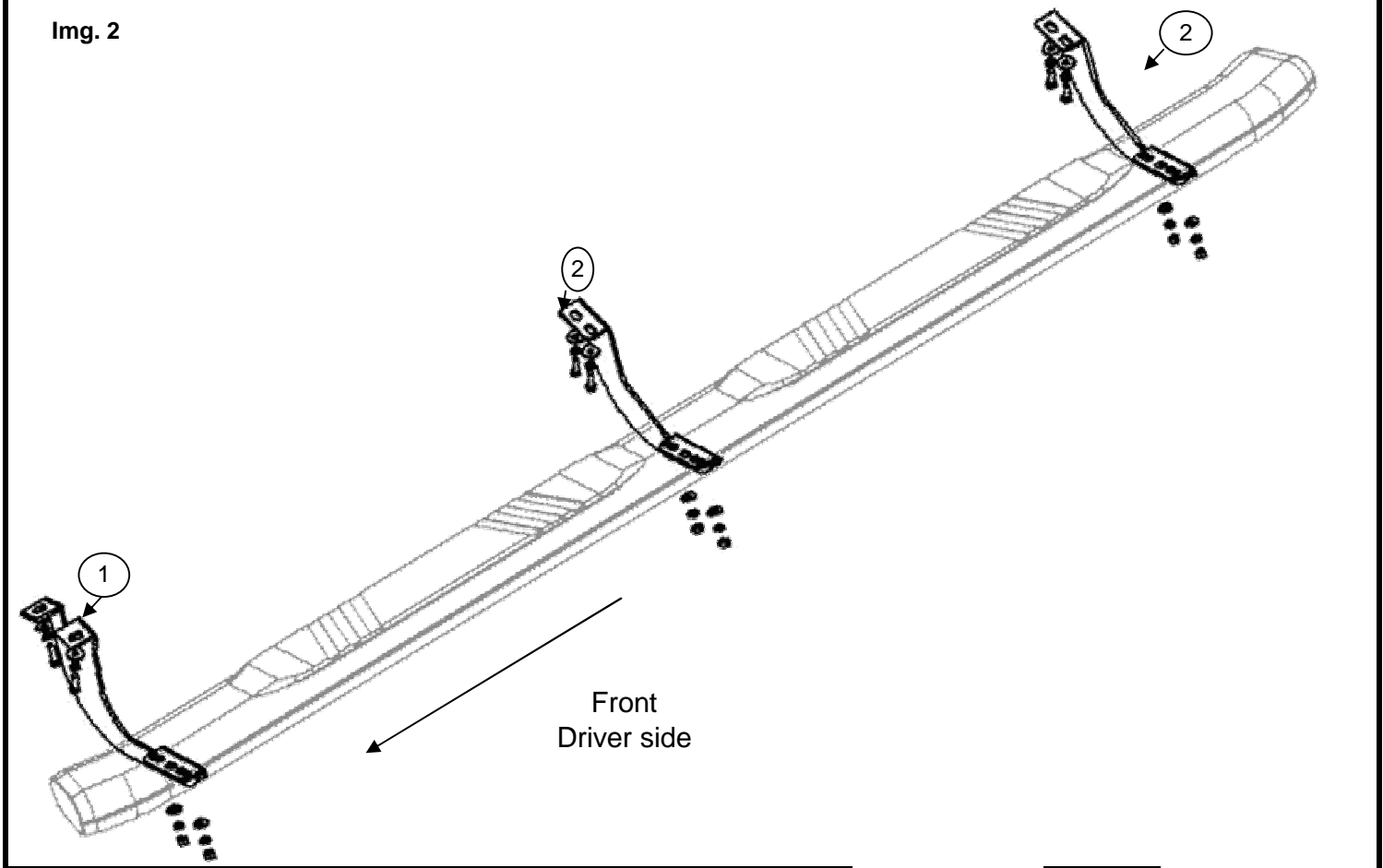

Cleaning and care instructions: Design: Quality:

Protect the finish with a non-abrasive automotive wax, (e.g. Pure Carnauba) on a regular basis. The use of any soap, polish, or wax that contains an abrasive is detrimental to the finish, as the compounds scratch the finish and cause corrosion.

INSTALLATION INSTRUCTIONS

1. Before beginning the installation read all instructions carefully and verify that all hardware is accounted for. If there are any listed parts missing, please notify your distributor immediately.
2. See pictures 3, 3a y 3b and locate the holes where the brackets are going to be installed.

Pict. 3

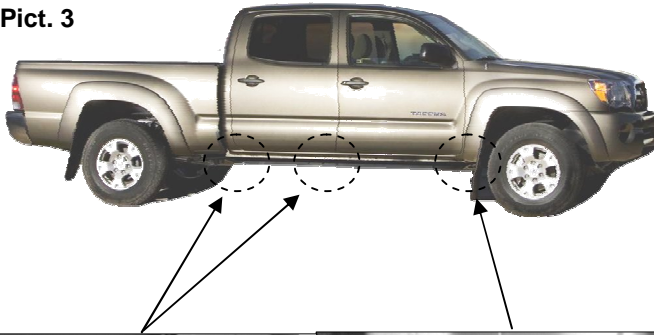

Pict. 3a

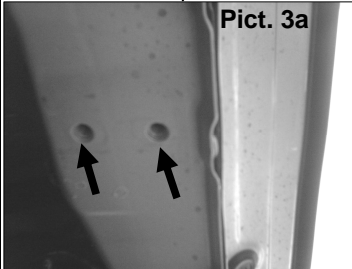

Pict. 3b

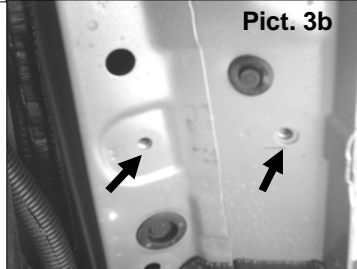

3. For the **Front bracket** install two M8x25 hex head galvanized bolts, two flat washers and two lock washers. See **Picture 4** and repeat it in the opposite side of the vehicle. Leave loose.

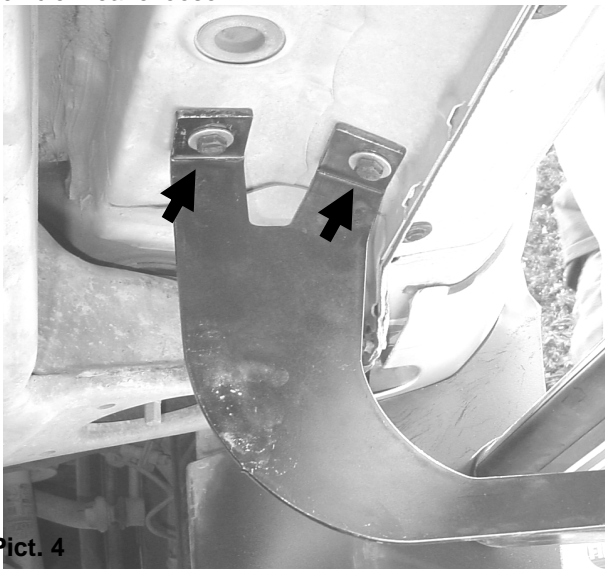

Pict. 4

4. To install **middle and rear brackets** use two M8x30 hex head galvanized bolts, two flat washers and two lock washer for each bracket. See **Picture 5** and repeat it in the opposite side. Leave loose.



Pict. 5

5. Now Proceed to install the running board / sidebar (Sold separately)
6. To install the Running Board, place three square head per each channel that it's located on the bottom (discard middle channel) Refer to **Picture 7**.

Pict. 7

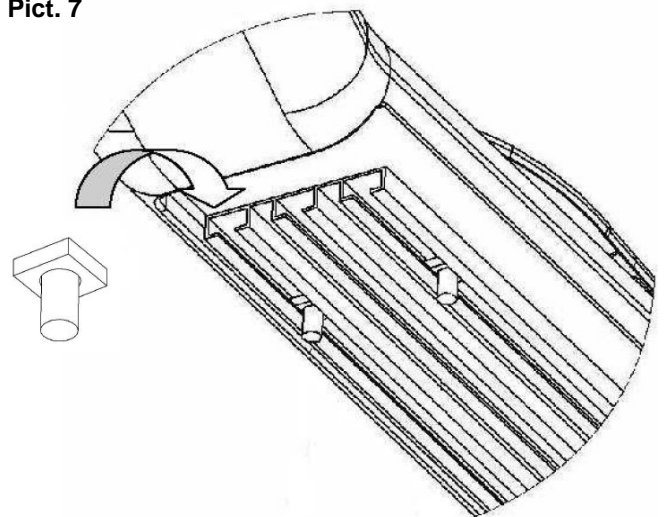

Cleaning and care instructions:

Protect the finish with a non-abrasive automotive wax, (e.g. Pure Carnauba) on a regular basis. The use of any soap, polish, or wax that contains an abrasive is detrimental to the finish, as the compounds scratch the finish and cause corrosion.

Revised: 20/02/12

Design:

Quality:

INSTALLATION INSTRUCTIONS

7. Place the Running Board above the brackets attach it with six 5/16" nuts, six flat washers and six lock washers, per side all in black color. See **Picture 8** and repeat in the opposite side. Leave loose.



8. If you are going to install an oval sidebar use two flat washers, two lock washers and two 5/16" nuts per bracket (all hardware in black). See **Picture 9** and repeat in the opposite side. **Leave loose.**

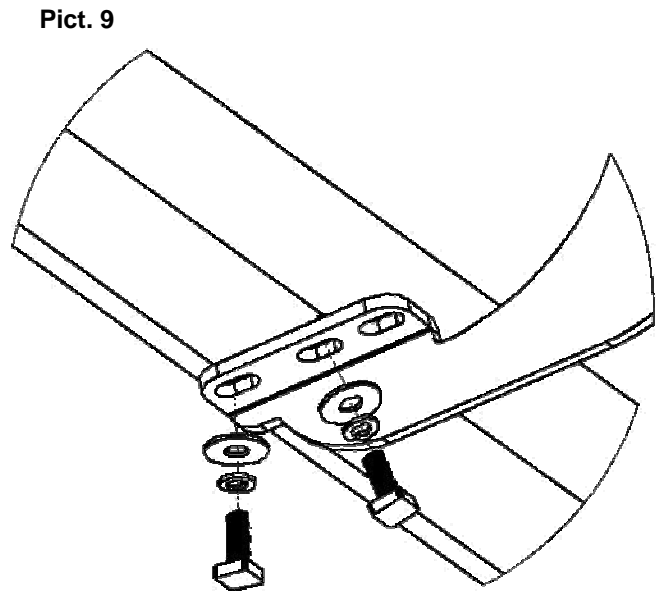

9. Align Side bar, and then get tighten all bolts.

10. Do not use abrasive substances to clean your product.

11. Periodically check your product because it may need a re-tighten of bolts.

12. **Fill the warranty card and place it inside your vehicle's glove box.**

Cleaning and care instructions:

Protect the finish with a non-abrasive automotive wax, (e.g. Pure Carnauba) on a regular basis. The use of any soap, polish, or wax that contains an abrasive is detrimental to the finish, as the compounds scratch the finish and cause corrosion.

Revised: 20/02/12

Design:

Quality: