

Parts List				
Item	QTY	Code	Description	Max Torque
1	2 pcs	3912670AA	Front Bracket	
2	1 set	3912670BA	Rear Bracket	
3	1 set	3912674CA	Auxiliary rear bracket	
4	8 pcs	3912670CA	3/8" bolt plate	
5	2 pcs	3713312	5/16" bolt plate	
6	2 pcs		3/8 x 1" Hex bolt	
7	10 pcs		3/8" flat washer	
8	10 pcs		3/8" lock washer	
9	10 pcs		3/8" hex nut	36 Lb. Ft.
10	2 pcs		5/16" flat washer zinc plated	
11	2 pcs		5/16" lock washers zinc plate	
12	2 pcs		5/16" hex nut zinc plated	20 Lb. Ft.
13	8 pcs		5/16" square head bolt	13 Lb. Ft.
14	8 pcs		5/16" flat washer	
15	8 pcs		5/16" lock washer	
16	1 pc		5/16" bolt guide	

Required Tool:

- A. Ratchet w/5" extension
- B. 9/16" Wrench & Socket
- C. 1/2" Long socket
- D. 15mm wrench or 17mm 12-point socket

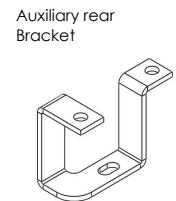
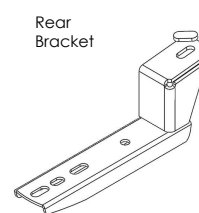
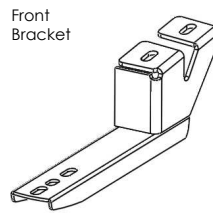

1. Before beginning the installation read all instructions thoroughly and verify that all hardware is accounted for. if there are any listed parts missing, please notify your distributor immediately.

2. To maintain and care this product keep it clean and do not use abrasive cleaners or polish waxes. It is recommended to use only non-abrasive automotive wax such as pure carnauba to avoid scratches and rust.

3. The approximate installation time is **30 min.**

Picture 1

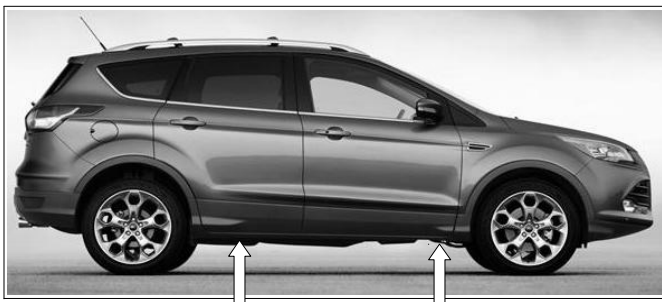

Picture 2

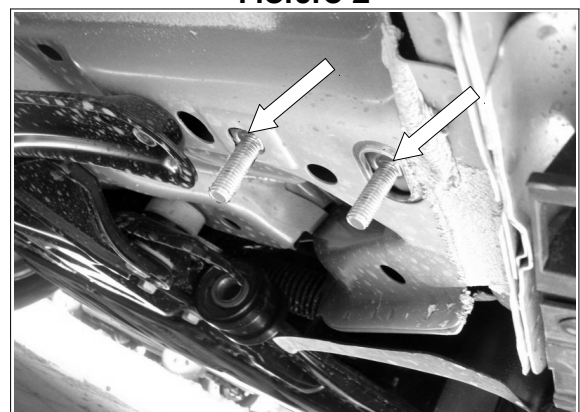

4.- Beginning with the passenger side. Locate underneath the vehicle at front and rear of the platform the bracket's fixation points. Picture 1.

5. To install the front bracket insert (2) 3/8" bolt plate into the existing obround and hole. Picture 2 .

Picture 3



Picture 4



6. Place and attach the front bracket to the 3/8" bolt plates using (1) 3/8" flat washer, (1) 3/8" lock washer and (1) 3/8" hex nut by each bolt. Leave loose. Picture 3.

7. To install auxiliary rear bracket locate the existing hole and the plastic clip holding the side skirt. Picture 4. Remove the clip pulling carefully until release then slide to remove it, discard the clip for this installation. Insert a 5/16" bolt plate using the bolt guide, insert the point of the guide through the existing hole until the obround where the clip was removed . Picture 5. Then pull the guide to position the bolt so it extends out through the clip's obround. Insert a 3/8" bolt plate into the existing hole where the guide was inserted. Place auxiliary rear bracket and attach to the 5/16" bolt plate with (1) 5/16" flat and lock washers and (1) 5/16" hex nut. Secure to the 3/8" bolt plate using (1) 3/8" flat and lock washers and (1) 3/8" hex nut. Picture 6. **NOTE:** For an easier installation of the auxiliary rear bracket you could knotted the side skirt as shown dot line in picture 6.

Picture 5



Picture 6

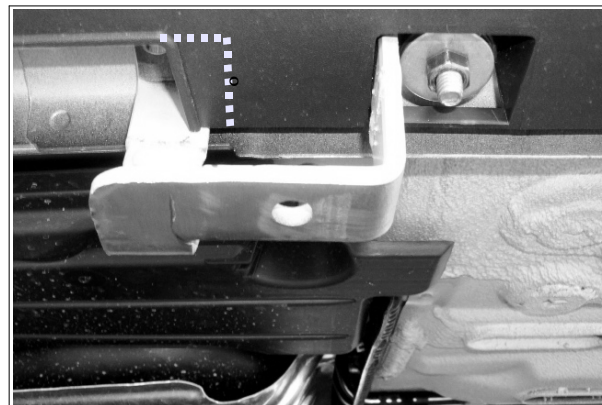

8. Locate the existing hole behind the auxiliary rear bracket. Insert a 3/8" bolt plate then place the rear bracket and secure using (1) 3/8" flat and lock washers and (1) 3/8" hex nut. Picture 7.

Picture 7



Picture 8



9. Secure auxiliary rear bracket to the rear bracket with (1) 3/8" x 1" hex bolt, (1) 3/8" flat and lock washers, and (1) 3/8" hex nut. Picture 8.

10. Place the passenger widesider on top of the mounting brackets. Position (2) of the U-brackets (included with the widesider) inside the widesider body, and align the U-brackets with the mounting brackets using the two holes nearest to the tip. Attach the widesider to the U-brackets to each mounting brackets using (2) 5/16" square head bolts, (2) 5/16" flat washers and (2) 5/16" lock washers.

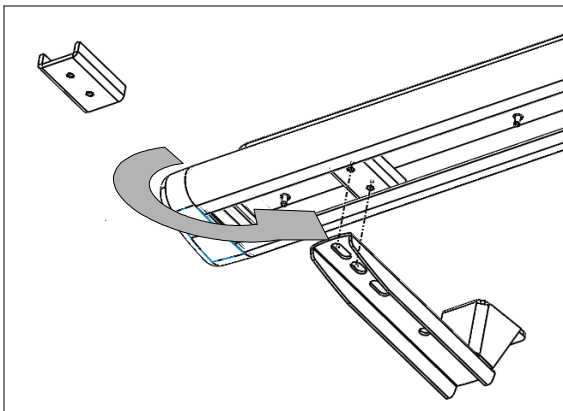

11.



the widesider with the vehicle and tighten the mounting brackets and square bolts. Repeat the installation steps to install the driver side brackets and widesider. Remember to periodically check and retighten all nuts and bolts.

INSTALLATION INSTRUCTIONS

UNIVERSAL RUNNING BOARD

Parts List				
Item	Qty.	Code	Description	Max. Torque
1	1 Set	-	Running Board	-
2	6 Pc.	396804AA	U (Clamp) Bracket *	-

* Wheel to Wheel Running Boards have the U (Clamp) Brackets included on the Bracket Kit (Sold Separately)

Required Tools (Not included)	
Qty.	Description
1	15mm Wrench
1	17mm Socket
1	Ratchet

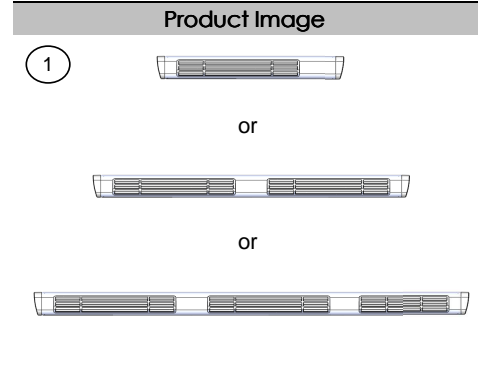

Instructions

1. Before beginning the installation, please read all directions carefully and verify that all necessary hardware is accounted for. If any parts are missing, stop the installation and contact your distributor immediately.
2. To maintain and care this product keep it clean and do not use abrasive cleaners or polish waxes. We recommend to use only non-abrasive automotive wax such as pure carnauba to avoid scratches and rust.
3. Once the main brackets are installed **(sold separately)**, the approximate installation time is **15 min.**
4. Place the U brackets inside the Running Board. Move them to align to the main brackets. **See illustration 1.**
5. Place the flat and lock washers with the square head bolts. This hardware kit is included on the main brackets that are **(sold separately)**. **See illustration 1.**
6. Align the Running board and tighten the bolts using a 1/2" wrench.
7. **NOTE: For some regular cabs only two U brackets are needed per side.**

ILLUSTRATION 1.

