



**INSTALLATION INSTRUCTIONS**  
**RB10 SIDE STEPS PART # 63492648T**  
**2011-2016 JEEP WRANGLER 2 DOOR**

**Do not attempt to install this product on any vehicle other than the one listed above!**

**PARTS LIST**

ITEM	QTY.	PART #	DESCRIPTION	TORQUE
1	1 Piece	630048T	RB10 Side Steps passenger	-
2	1 Piece	630048T	RB10 Side Steps driver	-
<b>3</b>	<b>1 Set</b>	<b>BRK-6349265</b>	<b>Hardware brackets kit</b>	-
4	4 Piece	6345050AA	Front & Rear bracket	-
5	4 Piece	6300874AA	U bracket	-
<b>7</b>	<b>1 Set</b>	<b>KTE-634505</b>	<b>Hardware kit</b>	-
8	8 Piece	-	5/16 x 1" Hex head bolt black plated	11 Lb.ft
9	8 Piece	-	5/16" Flat washer black plated	-
10	8 Piece	-	5/16" Lock washer black plated	-
11	8 Piece	-	1/4 x 1" Hex head bolt zinc plated	20 Lb.ft
12	16 Piece	-	1/4" Flat washer zinc plated	20 Lb.ft
13	8 Piece	-	1/4" Lock washer zinc plated	20 Lb.ft
14	8 Piece	-	1/4" Hex nut zinc plated	-
15	4 Piece	-	5/16" Clip nut zinc plated	-
16	4 Piece	-	M8 x 25mm Hex head bolt zinc plated	-
17	4 Piece	-	5/16 x 1" Hex head bolt zinc plated	-
18	4 Piece	-	5/16" Flat washer zinc plated	-
19	4 Piece	-	5/16" Lock washer zinc plated	-

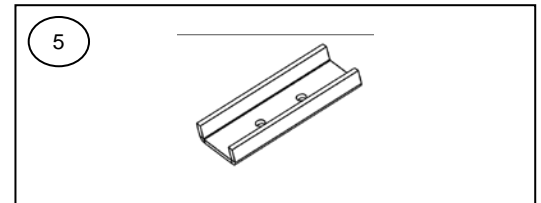
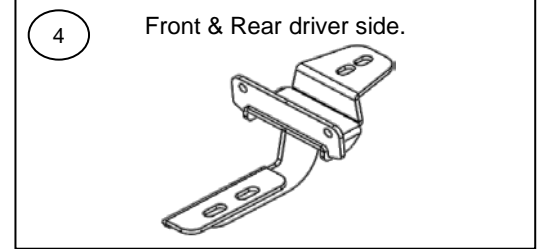

**ASSEMBLY & INSTALLATION TOOLS REQUIRED:**

- 3/8" Socket & 3/8" Wrench
- 7/16" Socket & 7/16" Wrench
- 13 mm Socket & 13 mm Wrench
- Ratchet
- Extension.

**Approximate installation time: 40 min.**

Read the assembly and installation instructions completely and verify that all of the parts listed are accounted for. If you have defective, missing or damaged parts or need assistance, please contact Go Rhino Products for fast, friendly customer service at: 1-888-427-4466 or email: [warranty@gorhino.com](mailto:warranty@gorhino.com)

It is the customer's responsibility to protect the finish with a regular application of a nonabrasive polish compatible with the products finish. **NOTE: Look the position before installing the brackets.**

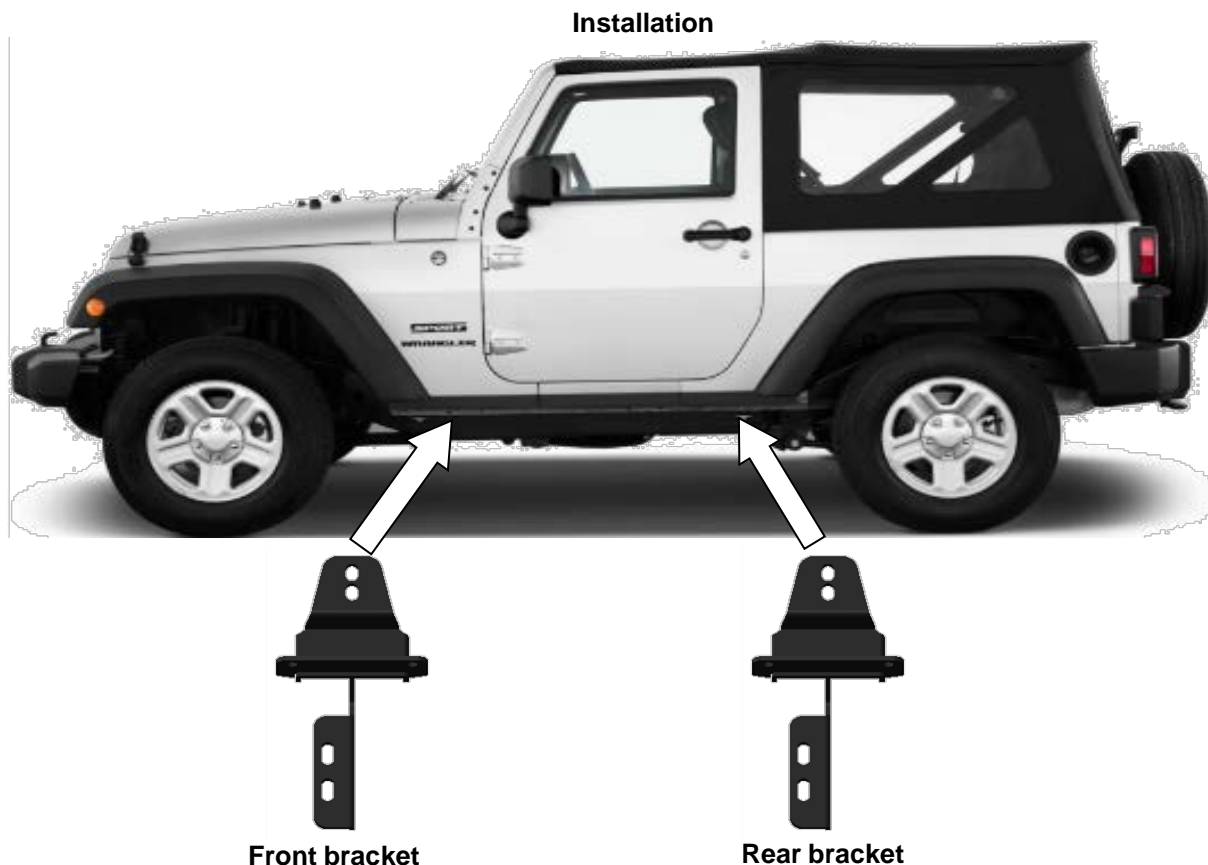

If the vehicle is equipped with factory slider bars, remove the fasteners, brackets and sliders bars from the vehicle.

**Step-1** This installation uses (2) mounting brackets per side. Begin by installing the driver side front bracket. Locate the holes in the body pinch mold and in the under side of the body. Remove the black tape covering the round hole in the body and install (1) 5/16" U-nut as shown. **Photo #1**

**Step 2.** Attach (1) front mounting bracket to the pinch mold using (2) 1/4" X 1" Hex bolts, flat washers, lock washers, hex nuts and to the body using (1) 5/16" X 1" hex bolt, lock washer and flat washer. **Photo #2**

Photo 1

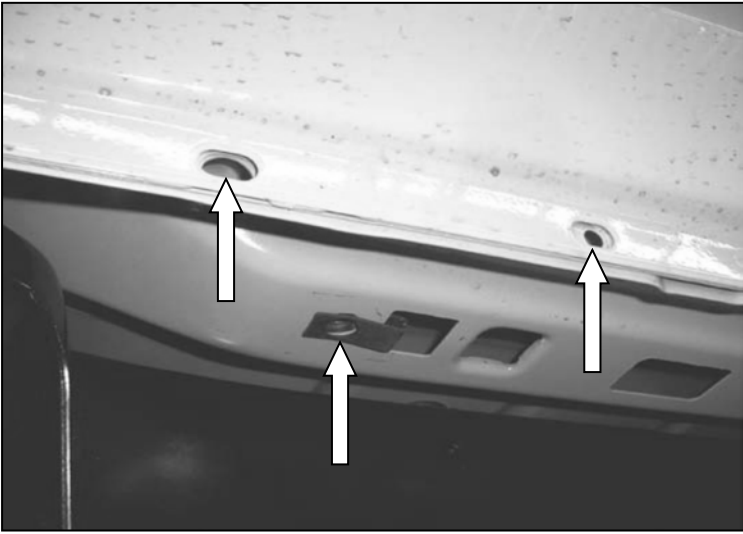
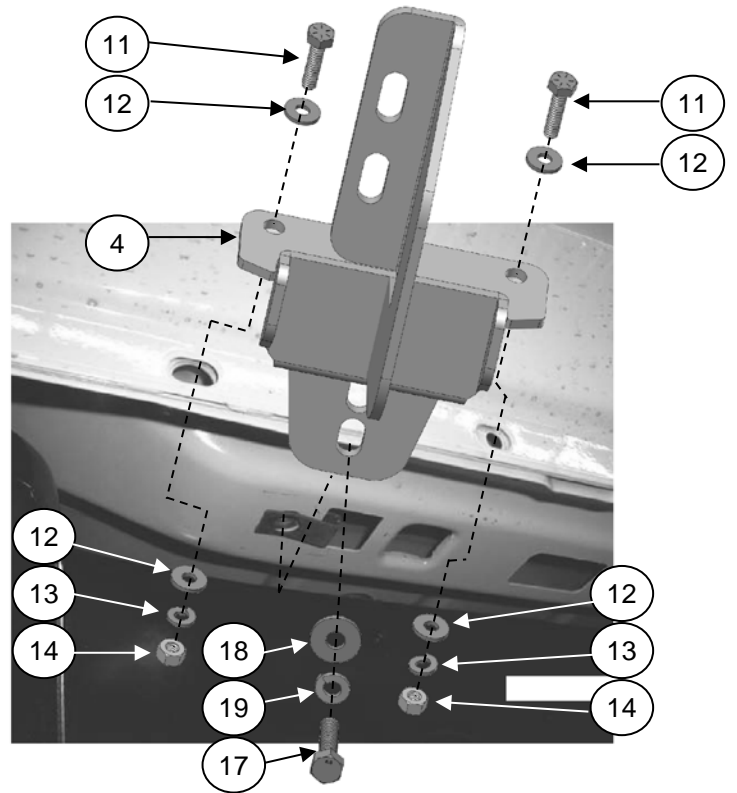

Photo 2



**STEP 3.** Repeat the above procedure to install (1) rear mounting bracket. Do not tighten. **Photo #3 & Photo #4**

Photo 3

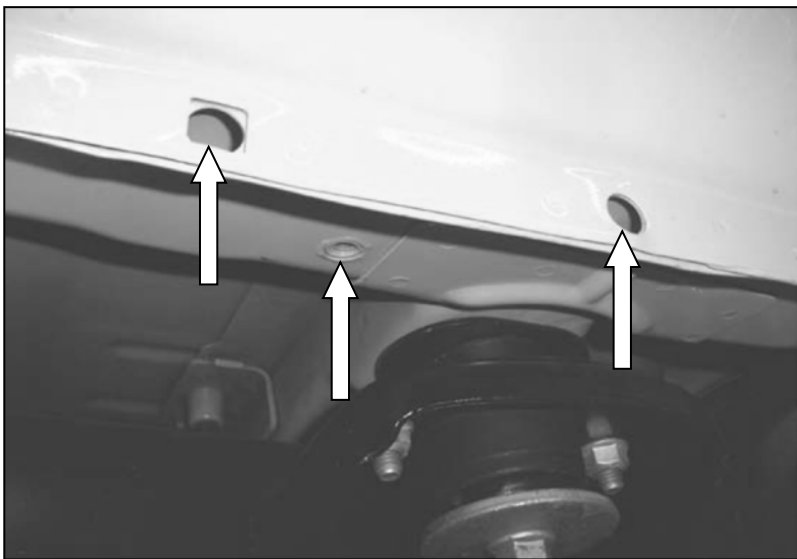

Photo 4

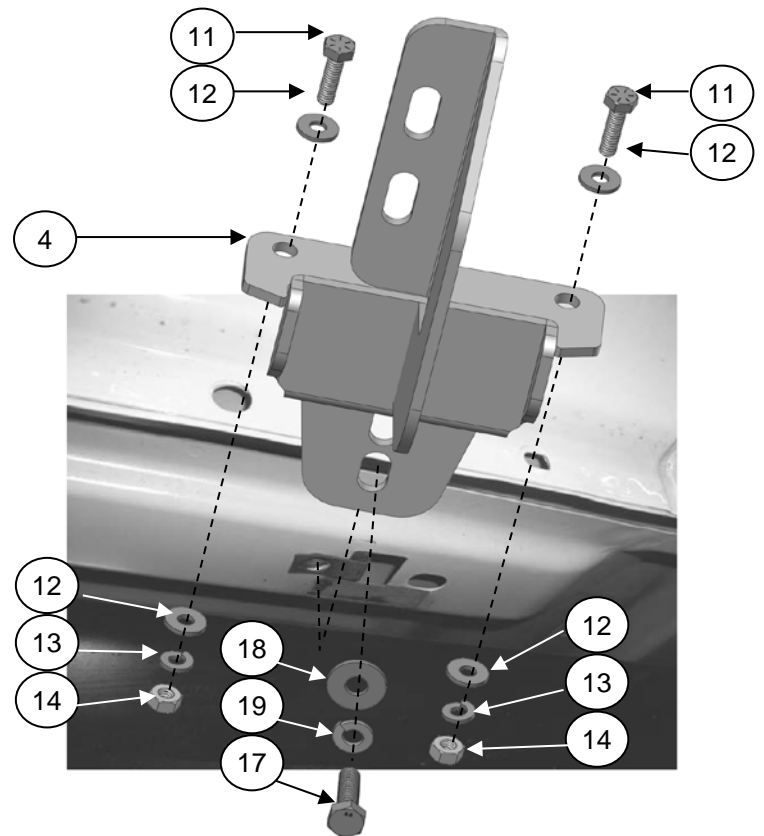

PHOTO 7



**Step 4.** Place the " U " bracket inside RB10 Side Step, place the RB10 Side Step on brackets and attach with: 5/16" Hex head bolt, 5/16" flat and lock washers ( Black plated ), By each bracket. **Photo # 5.**

**Step-5** Align the RB10 Side Step and then tighten all bolts.

**Step-6** Periodically check your product because it may need a re.tighten all bolts.

**Step-7** Fill the warranty card and place it inside your vehicle's glove box.