

GO RHINO®

INSTALLATION INSTRUCTIONS



PART NO.

- 6940486

PRODUCT DESCRIPTION:

- Vertex V3 Bracket

APPLICATION:

- Chevrolet Silverado 1500 crew cab

PRODUCT SAFETY & LEGAL DISCLAIMER

- **IMPORTANT READ ALL INSTRUCTIONS CAREFULLY BEFORE INSTALLING, FAILURE TO DO SO MAY CAUSE PERSONAL INJURY OR DAMAGE TO PRODUCT AND/OR PROPERTY.**
- **Review the product package and contents prior to beginning the installation.** Take care when opening the packaging and removing items. If a return is needed you will want to return the product in its original packaging if possible.
- This instruction guide is provided as a GENERAL installation guide, some vehicles vary dimensionally and may require additional steps.
- Test fit the product on the vehicle prior to any third party modifications and or finishing. The manufacturer and/or distributors do not accept responsibility for third party charges, labor and or third part replacement modifications. Some modifications may void the factory warranty.
- Exercise due-diligence when installing this product. The manufacturer and distributors of this product do not accept any responsibility for vehicle damage or personal injury resulting from the installation of this product. Careless installation and operation can result in serious injury or equipment damage.
- This product is for general off-road use. All liability for installation and use rests with the owner/operator.
- **INSTALLER:** Once installation is complete, please return this guide along with other documentation included in this product back to the consumer for future reference. The manufacturer/distributors of this product do not guarantee this particular version will be available at a later date.



INSTALLATION INSTRUCTIONS

INJURY HAZARD

Please complete a shop and tool inspection prior to beginning the installation.

- Always make sure you have a clean, dry and well lit work area.
- Always remove jewelry, loose fitting clothing and wear protective gloves and eye protection.
- Always use extreme caution when jacking or raising a vehicle for work. Set the emergency brake and use tire/wheel blocks and jack stands. Refer to the vehicle manufacturer hand book. Utilize the vehicle manufacturers designated lifting points.
- Always use appropriate and adequate care in lifting parts during disassembly and installation. Seek help in lifting heavy or large items into place. Utilize jacks and or lifting devices when available.
- Always insure products are secure during disassembly and installation.
- Always wear eye protection and take steps to protect any exposed skin during the installations. Drilling, cutting and grinding plastic and metal may create flying particles that can cause injury.
- Always use extreme caution when drilling, cutting and or grinding on a vehicle. Thoroughly inspect the area to be drilled, on both sides of material, prior to modification and relocate any objects that may become damaged.
- Always assemble and tighten all fasteners per the installation instructions.
- Always route electrical cables carefully. Avoid moving parts, parts that may become hot and rough or sharp edges.
- Always insulate and protect all exposed wiring and electrical connections.

MAINTENANCE AND CARE

- Always perform regular inspections and maintenance on mounts and related fasteners.
- Periodically check and tighten all fasteners.
- Stripped, fractured, or bent fasteners must be replaced.
- After washing the vehicle make sure to fully dry all surfaces.
- In areas with cold temperatures make sure to wash the product often to remove harmful materials used on road ways.
- Never use abrasive cleaners or polish compounds. Clean with a gentle soap and water. If you use wax use a non-abrasive automotive wax such as pure carnauba wax.

WARNING

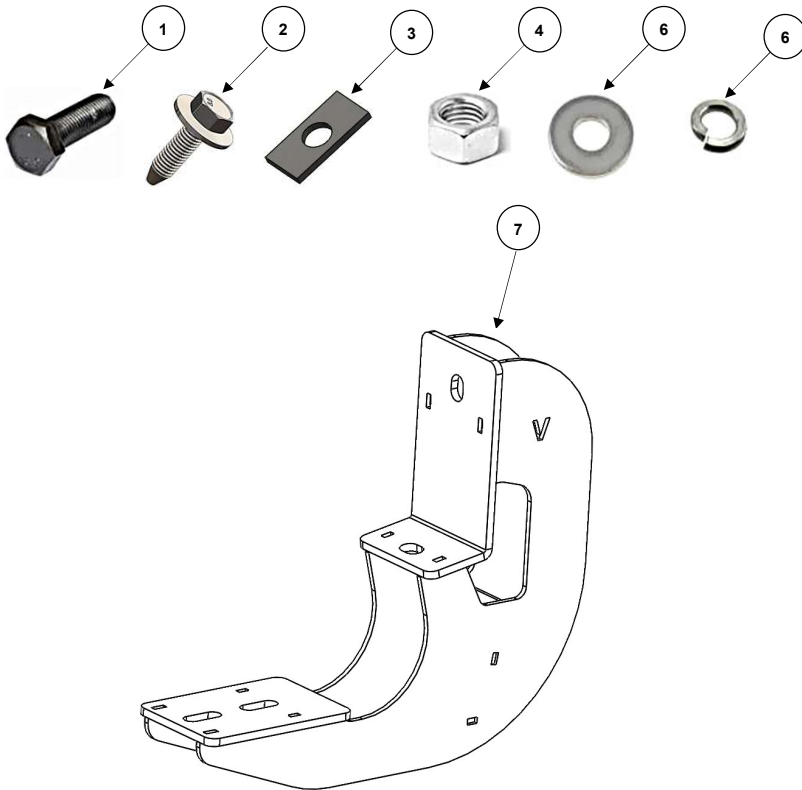
Some products have been designed to work together with factory rear sensor systems, factory forward facing sensor systems and factory air bags.

- Installation of some of these products may alter the factory sensor system performance.
- Factory sensors may read shackles or hooks protruding from the fairlead and or tow hooks.
- All sensor testing is completed by Go Rhino Products and or third party testing labs on modified vehicles.
- Sensor sensitivity, factory sensor housing, orientation, and operating conditions are all variables that will influence functionality of the sensors.
- Installation of some product may effect the factory air bag systems.
- Some products allow the use of third party products such as winches, shackles, hooks, etc. Follow the respective manufacturers operating instructions for use with our products.
- Make sure to fully understand the product, it's intended use and operation prior to use.

GO RHINO®

INSTALLATION INSTRUCTIONS

PARTS INCLUDED IN THIS LIST:



ITEM	QTY.	DESCRIPTION
1	16	M8 X 25MM. HEX BOLT
2	16	M8 X 30MM. SEMS HEX BOLT
3	16	BOLT SHIM
4	16	M8 – 1.25 HEX NUT
5	16	M8 FLAT WASHER
6	16	M8 LOCKWASHER
7	8 Pc.	VERTEX V3 BRACKET

Go Rhino recommends you, the installer, read this installation instruction manual from front to back before installing the product.

TOOLS NEEDED FOR INSTALLATION:

- 9/16" Socket & Wrench
- 13mm Socket & Wrench
- Ratchet & Extension

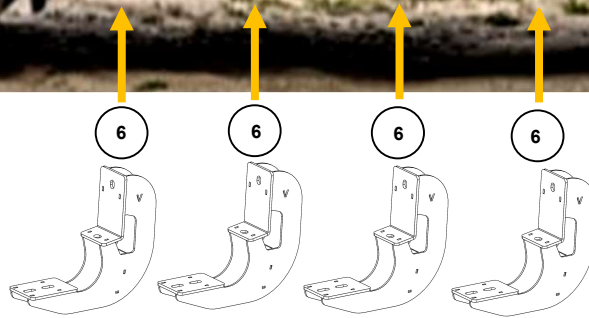
ESTIMATED TIME FOR INSTALLATION:

1 Hour

GO RHINO®

INSTALLATION INSTRUCTIONS

This installation requires 4 brackets for each side beginning the installation on the driver side of the vehicle.



GO RHINO®

INSTALLATION INSTRUCTIONS

Step-1 Locate and remove the plastic plugs covering the first set of threaded holes in the body panel.
Photos 1, 2, 4, & 5. Note: Hold a mounting bracket up in place to help determine the mounting holes to use along the body panel.

Step-2 Attach one of the Brackets to the body panel using the included (2) M8 X 30MM. Hex bolts. Do not tighten the bolts. **Photo 3.**

Photo 1



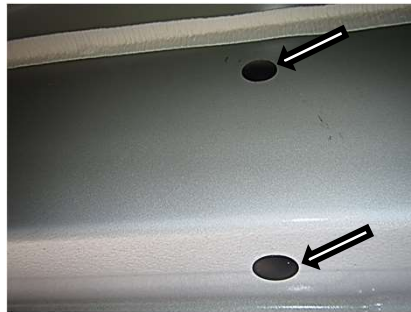
Driver side Rocker panel

Rear side
(Remove 2 plastic plugs only)

Threaded hold

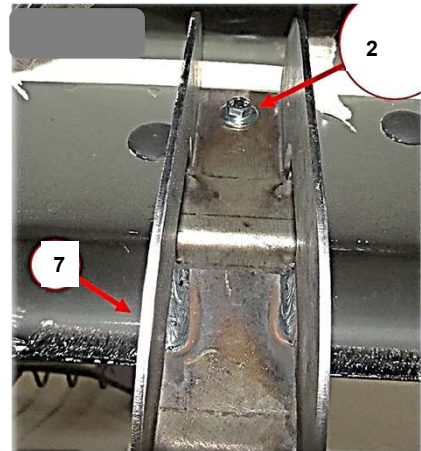


Photo 2



Rear center side

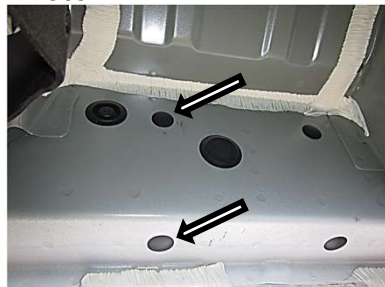
Photo 3



Step-3 Locate and remove the plastic plugs covering the first set of threaded holes in the body panel.
Photos 1, 2, 4, & 5. Note: Hold a mounting bracket up in place to help determine the mounting holes to use along the body panel.

Step-4 Attach one of the Brackets to the body panel using the included (2) M8 X 30MM. Hex bolts. Do not tighten the bolts. **Photo 6.**

Photo 4



Front center side
(Remove 2 plastic plugs only)

Threaded hold

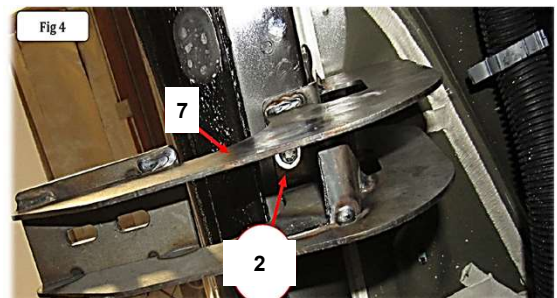


Photo 5



Front side

Photo 6



GO RHINO®

INSTALLATION INSTRUCTIONS

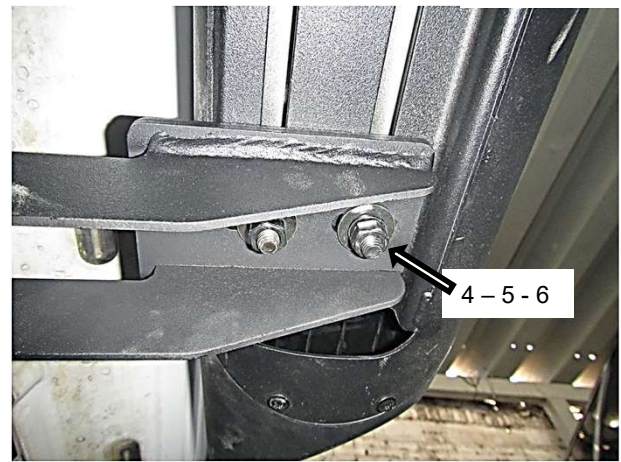
Step-5 Insert bolts in the rail of the inner aluminum extrusion at the underside of the side step. Each side step requires (8) M8 x 25mm. Hex bolts. **Photo 7.**

Step-6 Place the side step on the Brackets using, (8) M8 hex nut, (8) M8 flat washers & (8) M8 lock washers. Do not tighten the bolts. **Photo 8.**

Photo 7



Photo 8



Installed product

Step-7 Align the side step with the vehicle and tighten all brackets and side steps nuts and bolts. Repeat the above steps to install the passenger side brackets and side step. Remember to check and retighten the nuts and bolts every six months.