

# GORRHINO®

## INSTALLATION INSTRUCTIONS



### PART NO.

- D64299T

### PRODUCT DESCRIPTION:

- DOMINATOR D6 SIDE STEPS

### APPLICATION:

- RAM QUAD CAB

### PRODUCT SAFETY & LEGAL DISCLAIMER

- **IMPORTANT READ ALL INSTRUCTIONS CAREFULLY BEFORE INSTALLING, FAILURE TO DO SO MAY CAUSE PERSONAL INJURY OR DAMAGE TO PRODUCT AND/OR PROPERTY.**
- **Review the product package and contents prior to beginning the installation.** Take care when opening the packaging and removing items. If a return is needed you will want to return the product in its original packaging if possible.
- This instruction guide is provided as a GENERAL installation guide, some vehicles vary dimensionally and may require additional steps.
- Test fit the product on the vehicle prior to any third party modifications and or finishing. The manufacturer and/or distributors do not accept responsibility for third party charges, labor and or third part replacement modifications. Some modifications may void the factory warranty.
- Exercise due-diligence when installing this product. The manufacturer and distributors of this product do not accept any responsibility for vehicle damage or personal injury resulting from the installation of this product. Careless installation and operation can result in serious injury or equipment damage.
- This product is for general off-road use. All liability for installation and use rests with the owner/operator.
- **INSTALLER:** Once installation is complete, please return this guide along with other documentation included in this product back to the consumer for future reference. The manufacturer/distributors of this product do not guarantee this particular version will be available at a later date.



## INSTALLATION INSTRUCTIONS

### INJURY HAZARD

Please complete a shop and tool inspection prior to beginning the installation.

- Always make sure you have a clean, dry and well lit work area.
- Always remove jewelry, loose fitting clothing and wear protective gloves and eye protection.
- Always use extreme caution when jacking or raising a vehicle for work. Set the emergency brake and use tire/wheel blocks and jack stands. Refer to the vehicle manufacturer hand book. Utilize the vehicle manufacturers designated lifting points.
- Always use appropriate and adequate care in lifting parts during disassembly and installation. Seek help in lifting heavy or large items into place. Utilize jacks and or lifting devices when available.
- Always insure products are secure during disassembly and installation.
- Always wear eye protection and take steps to protect any exposed skin during the installations. Drilling, cutting and grinding plastic and metal may create flying particles that can cause injury.
- Always use extreme caution when drilling, cutting and or grinding on a vehicle. Thoroughly inspect the area to be drilled, on both sides of material, prior to modification and relocate any objects that may become damaged.
- Always assemble and tighten all fasteners per the installation instructions.
- Always route electrical cables carefully. Avoid moving parts, parts that may become hot and rough or sharp edges.
- Always insulate and protect all exposed wiring and electrical connections.

### MAINTENANCE AND CARE

- Always perform regular inspections and maintenance on mounts and related fasteners.
- Periodically check and tighten all fasteners.
- Stripped, fractured, or bent fasteners must be replaced.
- After washing the vehicle make sure to fully dry all surfaces.
- In areas with cold temperatures make sure to wash the product often to remove harmful materials used on road ways.
- Never use abrasive cleaners or polish compounds. Clean with a gentle soap and water. If you use wax use a non-abrasive automotive wax such as pure carnauba wax.

### WARNING

Some products have been designed to work together with factory rear sensor systems, factory forward facing sensor systems and factory air bags.

- Installation of some of these products may alter the factory sensor system performance.
- Factory sensors may read shackles or hooks protruding from the fairlead and or tow hooks.
- All sensor testing is completed by Go Rhino Products and or third party testing labs on modified vehicles.
- Sensor sensitivity, factory sensor housing, orientation, and operating conditions are all variables that will influence functionality of the sensors.
- Installation of some product may effect the factory air bag systems.
- Some products allow the use of third party products such as winches, shackles, hooks, etc. Follow the respective manufacturers operating instructions for use with our products.
- Make sure to fully understand the product, it's intended use and operation prior to use.
- Above all... be safe!

# GO RHINO®

## INSTALLATION INSTRUCTIONS

### PARTS INCLUDED IN THIS LIST:

ITEM	QTY.	DESCRIPTION	ITEM	QTY.	DESCRIPTION	ITEM	QTY.	DESCRIPTION
1	12	1/4" x 1" Button Head Bolt	6	12	5/16" Lock Washer	11	6	Vinyl Gasket
2	12	1/4" Flat Washer	7	12	5/16" Flat Washer	12	6	Side Step Bracket (Front, Center & Rear)
3	12	1/4" Lock Washer	8	24	3/8"-16 x 1-1/4" Hex Bolt	13	6	Nut-Plate
4	12	1/4" Hex Nut	9	24	3/8" Lock Washer	14	6	T-Plate
5	12	M8 x 25mm Hex Bolts	10	24	3/8" Flat Washer	15	2	Dominator D6 Side Step (Not Shown)

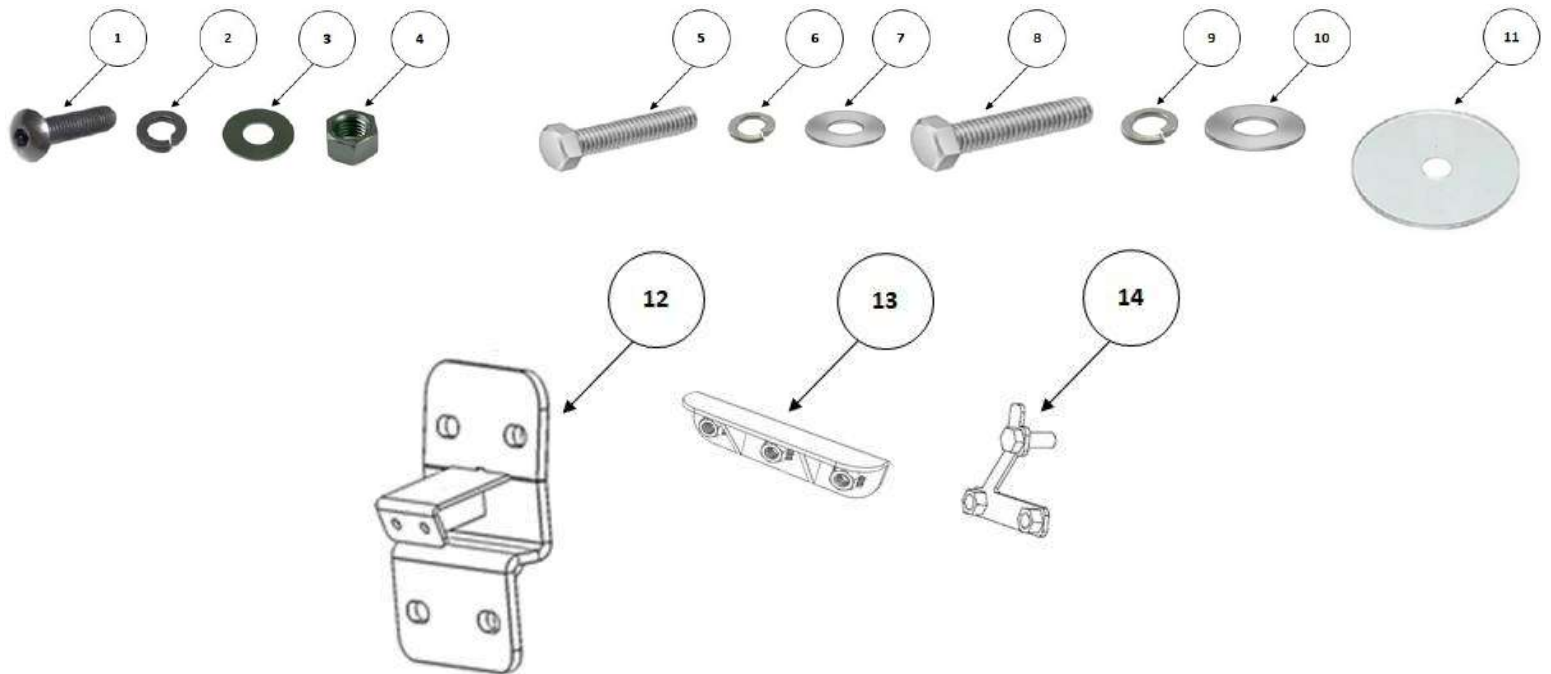

Go Rhino recommends you, the installer, read this installation instruction manual from front to back before installing the product.

### TOOLS NEEDED FOR INSTALLATION:

- 13mm, 7/16" & 9/16" Socket & Wrench
- 5/32" Hex Key
- Ratchet & Extension

ESTIMATED TIME FOR INSTALLATION:

1 Hour

# GO RHINO®

## INSTALLATION INSTRUCTIONS

This installation uses three side step brackets on each side of the vehicle. The attachment points are located on the rocker panel and the lower pinch weld, (FIGURE 1).

**FIGURE 1**



### Front Bracket

**Step-1** Begin the installation on the passenger side of the vehicle. If the vehicle has (2) hexagon shaped holes in the rocker panel at the front of the cab, remove the tape covering the obround hole in the rocker panel, and install (1) 3/8" T-Plate in the rocker panel and install (1) vinyl gasket over the threads to prevent the T-Plate from falling into the body, (FIGURE 2). Align the nuts welded to the T-Plate with the hexagon holes in the rocker panel and attach one of the side step brackets to the rocker panel using the T-Plate, (2) 3/8" X 1 1/4" hex bolts, (2) 3/8" flat washers and (2) 3/8" lock washers, (FIGURE 3). Leave the bolts loose for final adjustment.

**FIGURE 2**

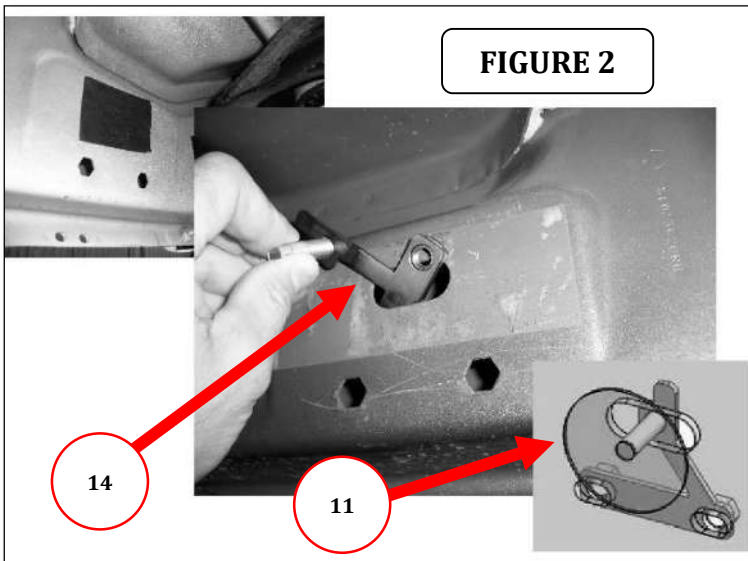

**FIGURE 3**

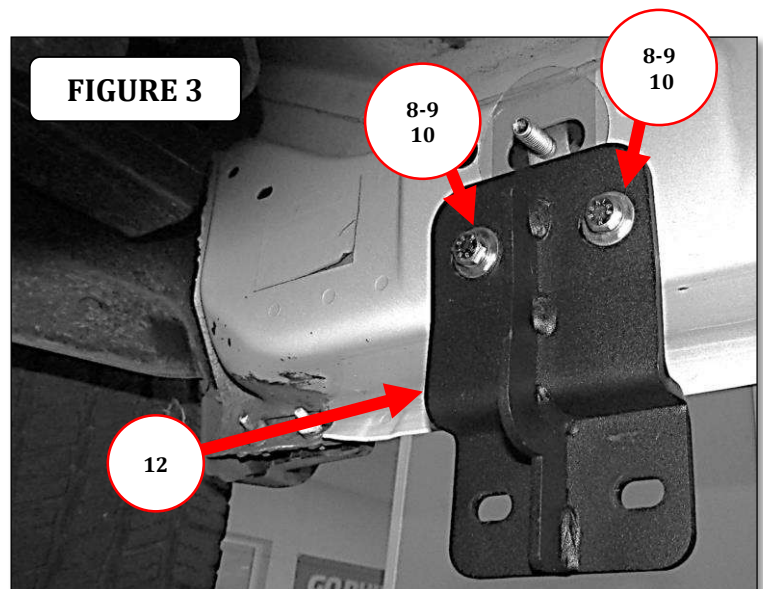

# GO RHINO®

## INSTALLATION INSTRUCTIONS

### Front Bracket

**Step-1.1** If the vehicle has (2) M8 threaded inserts in the rocker panel at the front of the cab, (FIGURE 4). Attach one of the side step brackets to the rocker panel using (2) M8 hex bolts, (2) 5/16" lock washers and (2) 5/16" flat washers, (FIGURE 5). Leave the bolts loose for final adjustment.

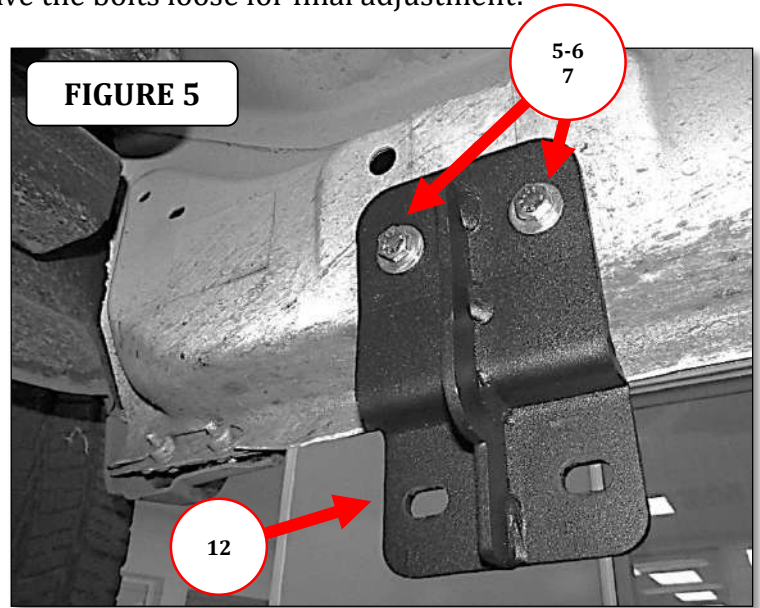
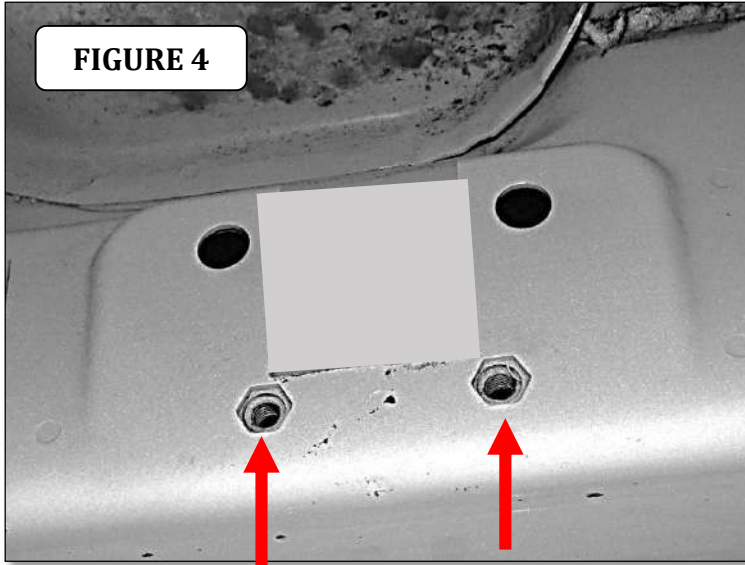

### Front Bracket

**Step-2** Attach the side step bracket to the holes in the vehicle body pinch weld using (2) 1/4" x 1" button head bolts, (2) 1/4" flat washers, (2) 1/4" lock washers and (2) 1/4" hex nuts, (FIGURE 6 & 7). Note: Drilling of two 1/4" holes might be necessary on pinch weld if factory holes are not present. Before drilling apply masking tape to the surface to be drilled to prevent paint chipping.

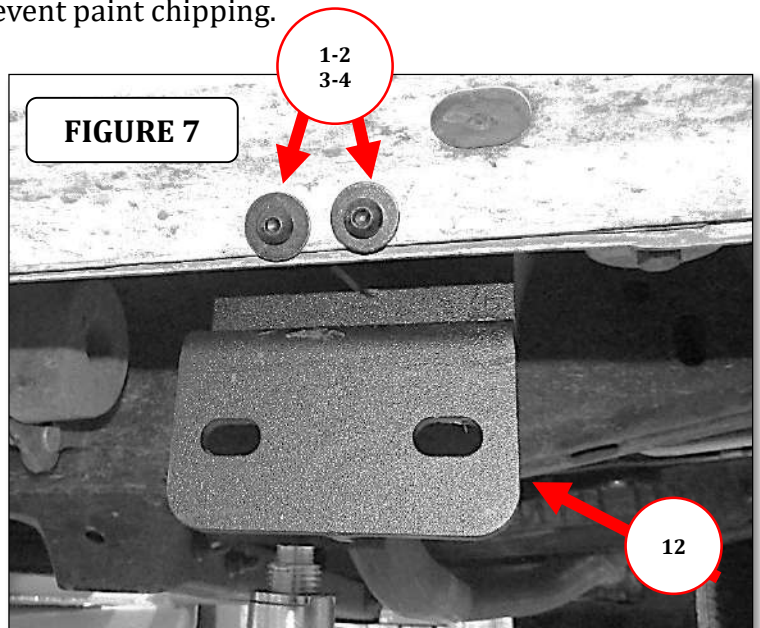
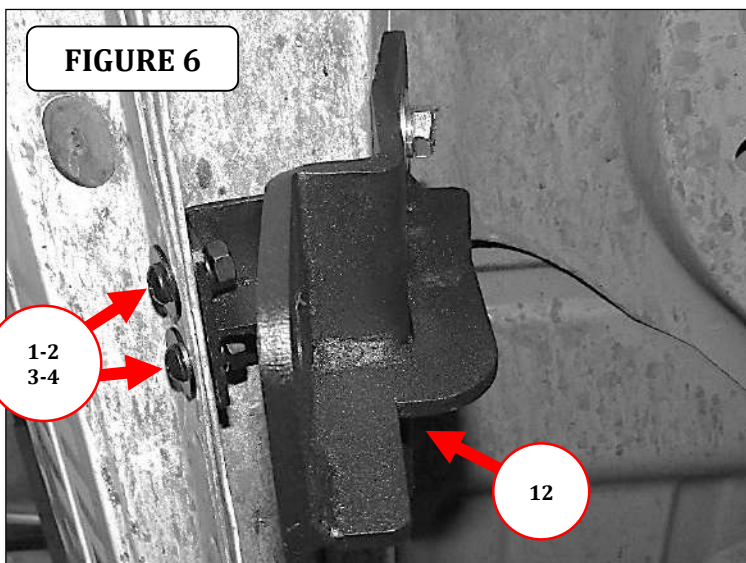

# GO RHINO®

## INSTALLATION INSTRUCTIONS

### Center Bracket

**Step-3** If the vehicle has hexagon holes in the rocker panel at the center of the cab, remove the tape covering the obround hole in the rocker panel, and install (1) 3/8" T-Plate in the rocker panel and install (1) vinyl gasket over the threads to prevent the T-Plate from falling into the body, (FIGURE 8). Align the nuts welded to the T-Plate with the hexagon holes in the rocker panel and attach one of the side step brackets to the rocker panel using the T-Plate, (2) 3/8" X 1 1/4" hex bolts, (2) 3/8" lock washers and (2) 3/8" flat washers, (FIGURE 9). Leave the bolts loose for final adjustment

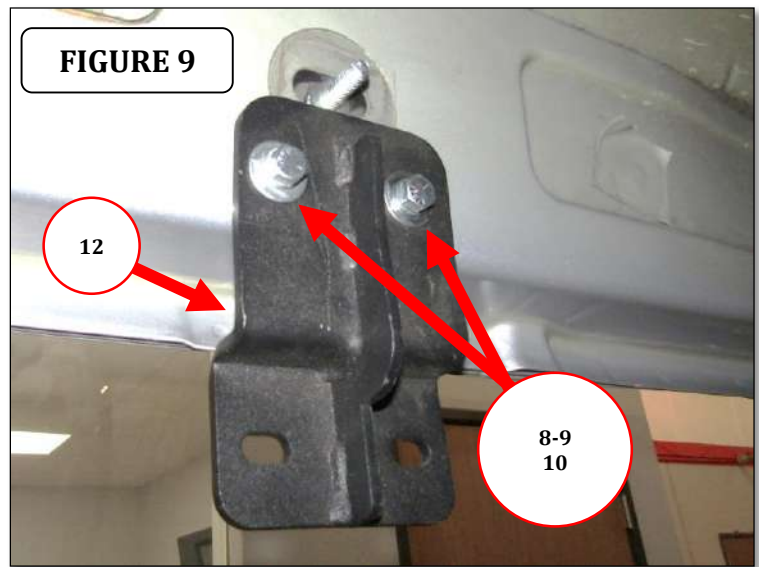
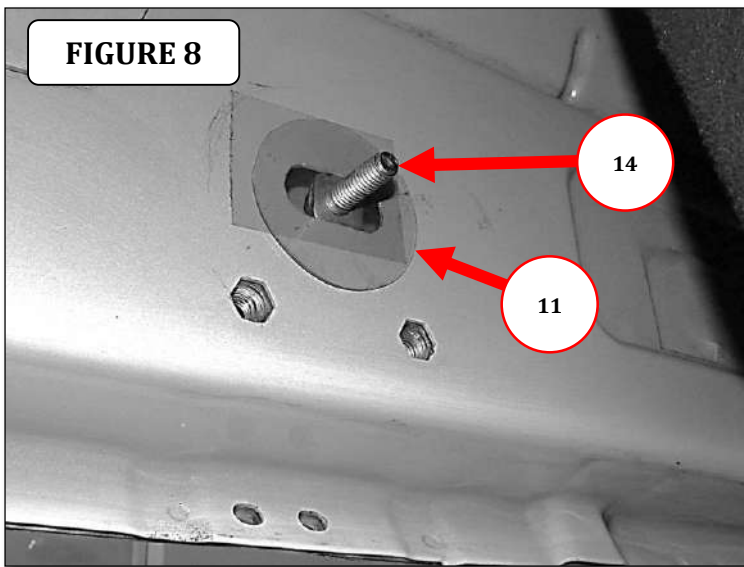

### Center Bracket

**Step-3.1** If the vehicle has (2) M8 threaded inserts in the rocker panel at the center of the cab, attach one of the mounting brackets to the rocker panel using (2) M8 hex bolts, (2) 5/16" lock washers and (2) 5/16" flat washers. Leave the bolts loose for final adjustment.

### Center Bracket

**Step-4** Attach the bracket to the holes in the vehicle body pinch weld using (2) 1/4" x 1" button head bolts, (2) 1/4" flat washers, (2) 1/4" lock washers and (2) 1/4" hex nuts. Note: Drilling of two 1/4" holes might be necessary on pinch weld if factory holes are not present. Before drilling apply masking tape to the surface to be drilled to prevent paint chipping.

# GO RHINO®

## INSTALLATION INSTRUCTIONS

### Rear Bracket

**Step-5** If the vehicle has hexagon holes in the rocker panel at the rear of the cab, remove the tape covering the obround hole in the rocker panel, and install (1) 3/8" T-Plate in the rocker panel and install (1) vinyl gasket over the threads to prevent the T-Plate from falling into the body, (FIGURE 10). Align the nuts welded to the T-Plate with the hexagon holes in the rocker panel and attach one of the side step brackets to the rocker panel using the T-Plate, (2) 3/8" X 1 1/4" hex bolts, (3) 3/8" flat washers, (3) 3/8" lock washers and (1) 3/8" hex nut, (FIGURE 11). Leave the nut and bolts loose for final adjustment.

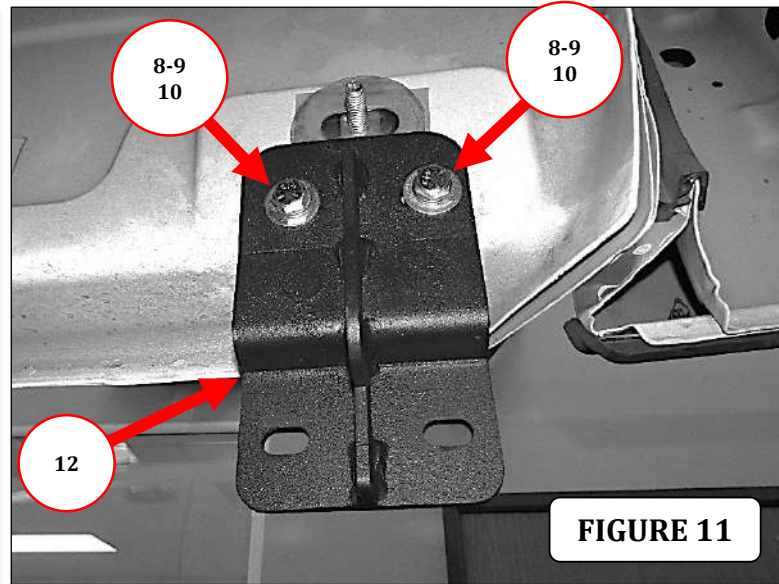
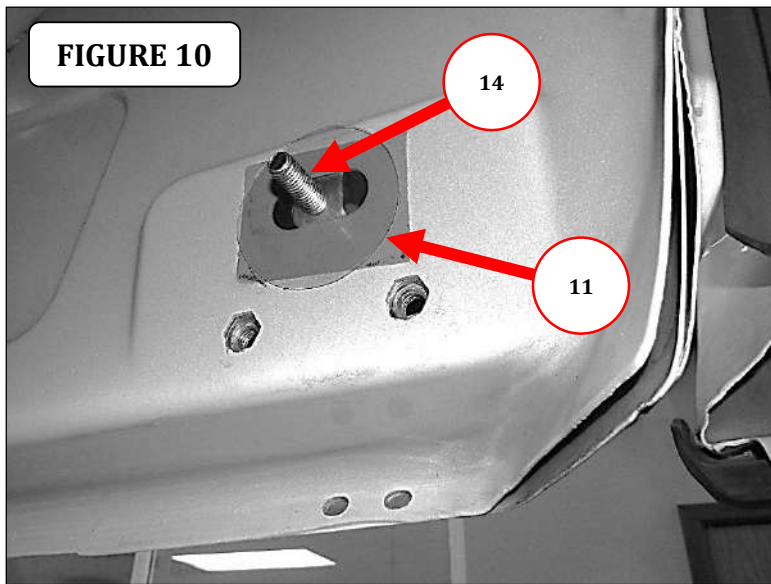

### Rear Bracket

**Step-5.1** If the vehicle has (2) M8 threaded inserts in the rocker panel at the rear of the cab, attach one of the side step brackets to the rocker panel using (2) M8 hex bolts, (2) 5/16" lock washers and (2) 5/16" flat washers. Leave the bolts loose for final adjustment.

### Rear Bracket

**Step-6** Attach the bracket to the holes in the vehicle body pinch weld using (2) 1/4" x 3/4" button head bolts, (2) 1/4" flat washers, (2) 1/4" lock washers and (2) 1/4" hex nuts. Note: Drilling of two 1/4" holes might be necessary on pinch weld if factory holes are not present. Before drilling apply masking tape to the surface to be drilled to prevent paint chipping.

# GORRHINO®

## INSTALLATION INSTRUCTIONS

**Step-7** Tighten all nuts and bolts securing the three brackets to the rocker panel and body pinch weld.

**Step-8** Insert three of the Nut-Plates through the rectangular opening in the back of the Dominator D6 running board, (FIGURE 12). Measure and position each Nut-Plate so it aligns with one of the three mounting brackets previously attached to the vehicle.

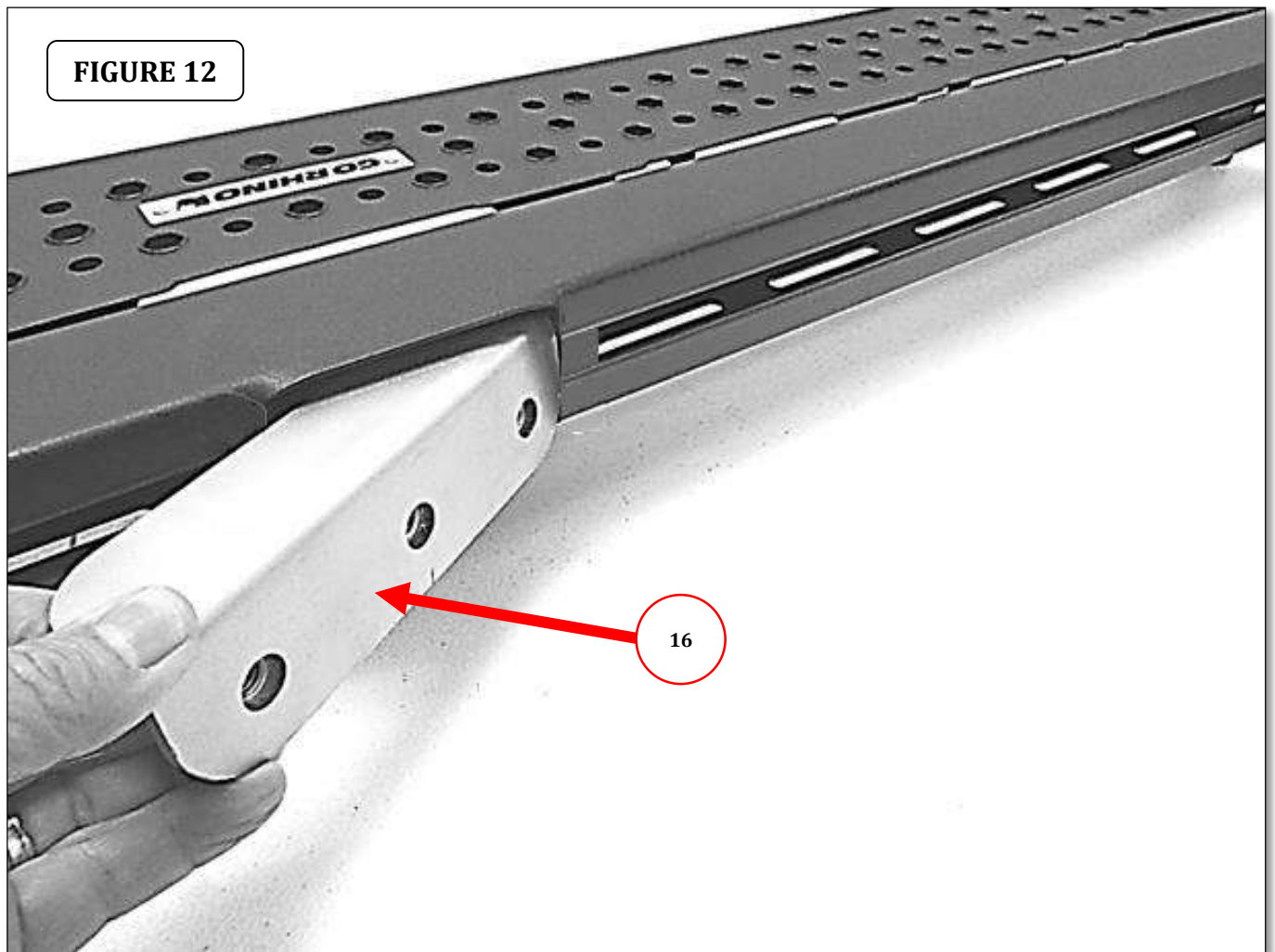



# GORRHINO®

## INSTALLATION INSTRUCTIONS

**Step-9** Attach one of the Dominator D6 side steps to each bracket using (2) 3/8" x 1 1/4" hex bolts, (2) 3/8" lock washers, (2) 3/8" flat washers, and (1) Nut-Plate.

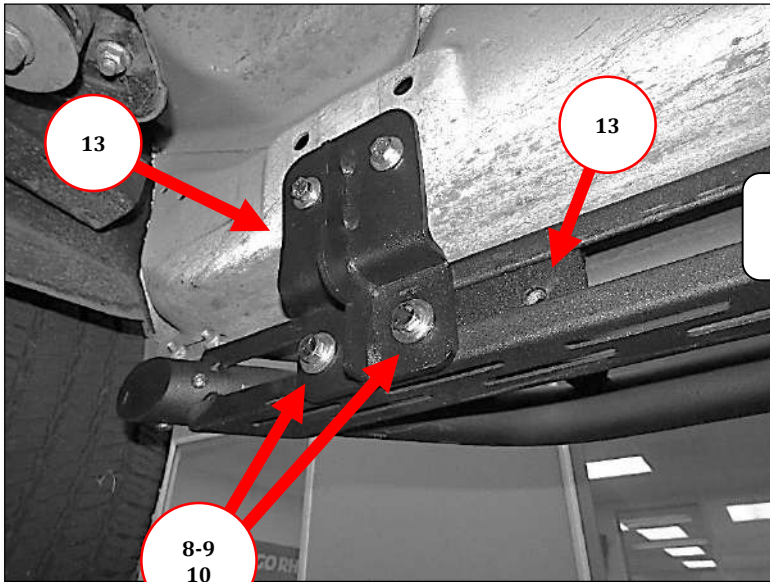

Passenger  
Front

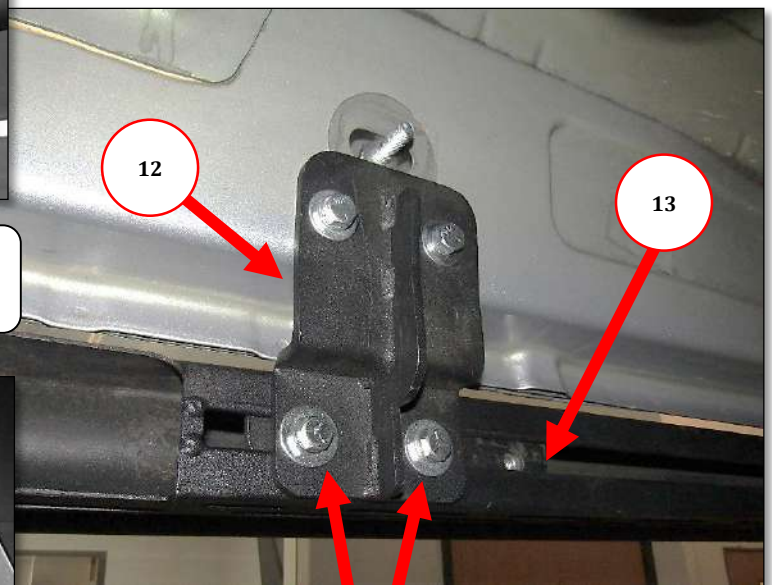

Passenger  
Center

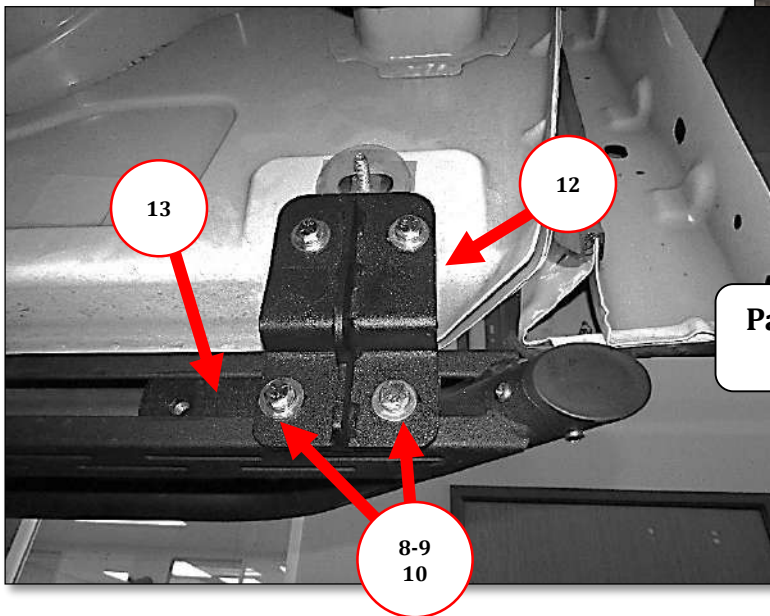

Passenger  
Rear

**Step-10** Tighten all bolts securing the Dominator D6 side step to the three side step brackets. Repeat the above steps to install the side step brackets and Dominator D6 side step on the driver side of the vehicle. Remember to check and retighten the nuts and bolts every six months.

Check out the collection of running boards and step bars we offer.