

GO RHINO®

INSTALLATION INSTRUCTIONS



PART NO.

- D14043T

PRODUCT DESCRIPTION:

- DOMINATOR D1 SIDE STEPS

APPLICATION:

- CHEVROLET SILVERADO 1500, 2500HD & 3500HD EXTENDED & DOUBLE CAB

- GMC SIERRA 1500 & 2500HD & 3500HD EXTENDED & DOUBLE CAB

PRODUCT SAFETY & LEGAL DISCLAIMER

- **IMPORTANT READ ALL INSTRUCTIONS CAREFULLY BEFORE INSTALLING, FAILURE TO DO SO MAY CAUSE PERSONAL INJURY OR DAMAGE TO PRODUCT AND/OR PROPERTY.**
- **Review the product package and contents prior to beginning the installation.** Take care when opening the packaging and removing items. If a return is needed you will want to return the product in its original packaging if possible.
- This instruction guide is provided as a GENERAL installation guide, some vehicles vary dimensionally and may require additional steps.
- Test fit the product on the vehicle prior to any third party modifications and or finishing. The manufacturer and/or distributors do not accept responsibility for third party charges, labor and or third part replacement modifications. Some modifications may void the factory warranty.
- Exercise due-diligence when installing this product. The manufacturer and distributors of this product do not accept any responsibility for vehicle damage or personal injury resulting from the installation of this product. Careless installation and operation can result in serious injury or equipment damage.
- This product is for general off-road use. All liability for installation and use rests with the owner/operator.
- **INSTALLER:** Once installation is complete, please return this guide along with other documentation included in this product back to the consumer for future reference. The manufacturer/distributors of this product do not guarantee this particular version will be available at a later date.



INSTALLATION INSTRUCTIONS

INJURY HAZARD

Please complete a shop and tool inspection prior to beginning the installation.

- Always make sure you have a clean, dry and well lit work area.
- Always remove jewelry, loose fitting clothing and wear protective gloves and eye protection.
- Always use extreme caution when jacking or raising a vehicle for work. Set the emergency brake and use tire/wheel blocks and jack stands. Refer to the vehicle manufacturer hand book. Utilize the vehicle manufacturers designated lifting points.
- Always use appropriate and adequate care in lifting parts during disassembly and installation. Seek help in lifting heavy or large items into place. Utilize jacks and or lifting devices when available.
- Always insure products are secure during disassembly and installation.
- Always wear eye protection and take steps to protect any exposed skin during the installations. Drilling, cutting and grinding plastic and metal may create flying particles that can cause injury.
- Always use extreme caution when drilling, cutting and or grinding on a vehicle. Thoroughly inspect the area to be drilled, on both sides of material, prior to modification and relocate any objects that may become damaged.
- Always assemble and tighten all fasteners per the installation instructions.
- Always route electrical cables carefully. Avoid moving parts, parts that may become hot and rough or sharp edges.
- Always insulate and protect all exposed wiring and electrical connections.

MAINTENANCE AND CARE

- Always perform regular inspections and maintenance on mounts and related fasteners.
- Periodically check and tighten all fasteners.
- Stripped, fractured, or bent fasteners must be replaced.
- After washing the vehicle make sure to fully dry all surfaces.
- In areas with cold temperatures make sure to wash the product often to remove harmful materials used on road ways.
- Never use abrasive cleaners or polish compounds. Clean with a gentle soap and water. If you use wax use a non-abrasive automotive wax such as pure carnauba wax.

WARNING

Some products have been designed to work together with factory rear sensor systems, factory forward facing sensor systems and factory air bags.

- Installation of some of these products may alter the factory sensor system performance.
- Factory sensors may read shackles or hooks protruding from the fairlead and or tow hooks.
- All sensor testing is completed by Go Rhino Products and or third party testing labs on modified vehicles.
- Sensor sensitivity, factory sensor housing, orientation, and operating conditions are all variables that will influence functionality of the sensors.
- Installation of some product may effect the factory air bag systems.
- Some products allow the use of third party products such as winches, shackles, hooks, etc. Follow the respective manufacturers operating instructions for use with our products.
- Make sure to fully understand the product, it's intended use and operation prior to use.
- Above all... be safe!

GO RHINO®

INSTALLATION INSTRUCTIONS

PARTS INCLUDED IN THIS LIST:

ITEM	QTY.	DESCRIPTION	ITEM	QTY.	DESCRIPTION
A	12	3/8"-16 x 1-1/4" Hex Bolt	H	6	M8-1.25 Hex Nut
B	12	3/8" Lock Washer	I	6	3/8" Nut-Plate
C	12	3/8" Flat Washer	J	2	Driver Side Front & Rear Bracket
D	12	M8-1.25 x 25mm Hex Bolt	K	1	Driver Side Center Bracket
E	12	5/16" Lock Washer	L	2	Passenger Side Front & Rear Bracket
F	18	5/16" Flat Washer	M	1	Passenger Side Center Bracket
G	6	M8-1.25 U-Nut	N	2	Dominator D1 Side Steps (Not Shown)

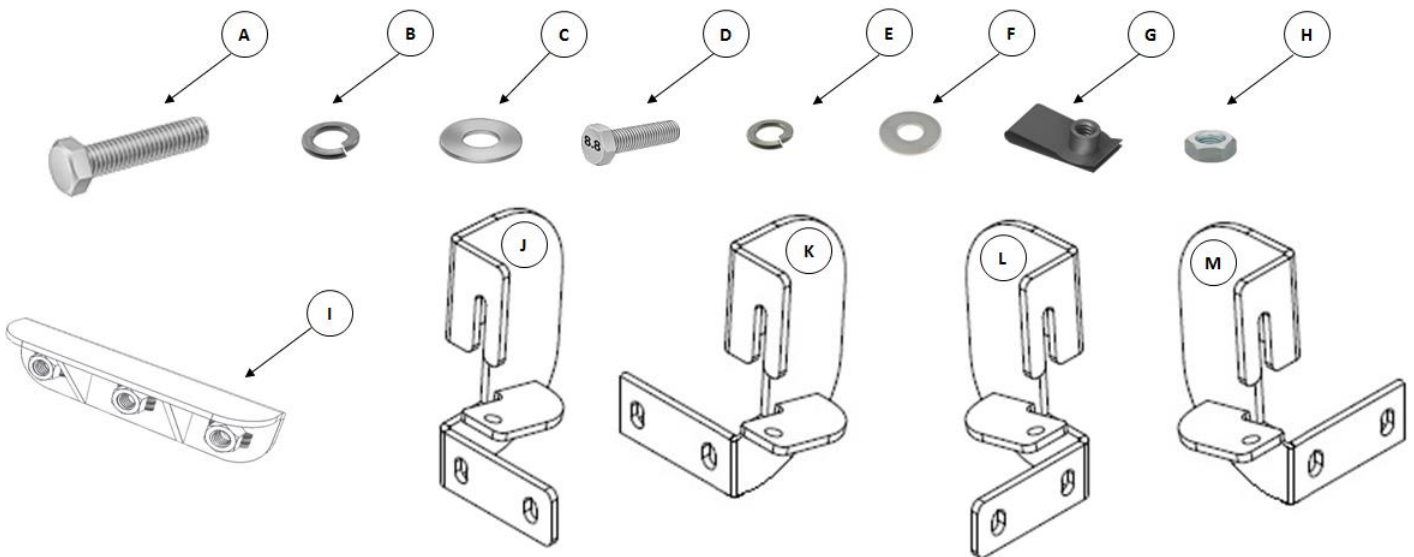

Go Rhino recommends you, the installer, read this installation instruction manual from front to back before installing the product.

TOOLS NEEDED FOR INSTALLATION:

- 9/16", 13mm Socket & Wrench
- Tape Rule
- Ratchet & Extension

ESTIMATED TIME FOR INSTALLATION:

1 Hour

GO RHINO®

INSTALLATION INSTRUCTIONS

This installation uses 3 brackets for each side. Begin the installation on the driver side of the vehicle.

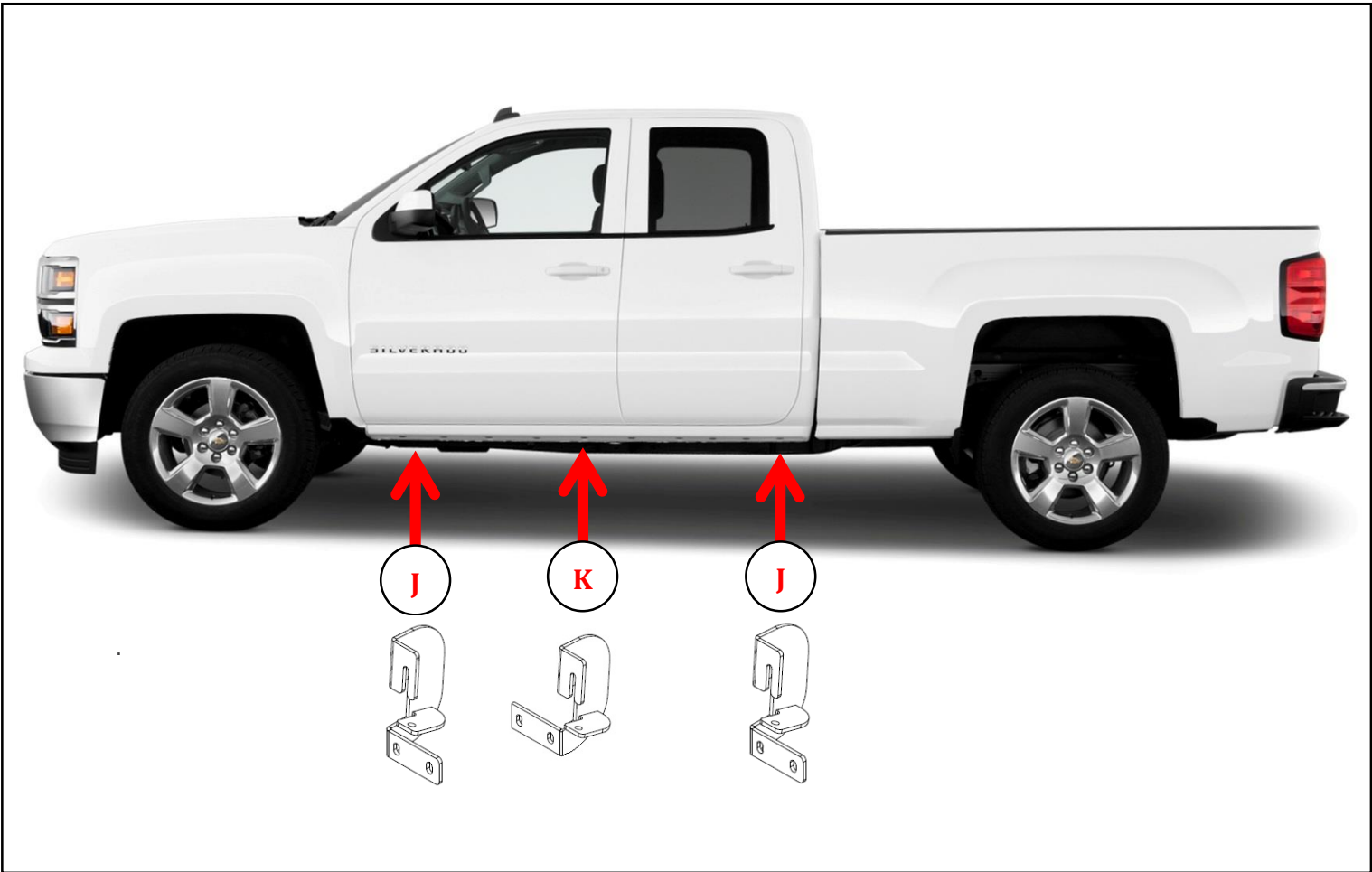

GO RHINO®

INSTALLATION INSTRUCTIONS

Step-1 Measure from the front fender bolt rearward approximately 14", (**Photo 1**) and locate the hole in the body pinch mold and the plastic plug in the rocker panel, (**Photo 2**). Remove the plastic plug from the rocker panel and install (1) M8 U-Nut in the rocker panel, (**Photo 2**).

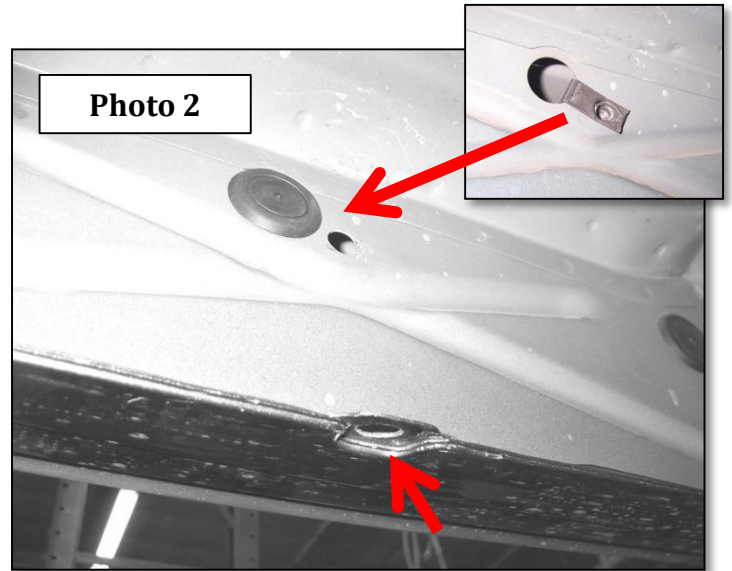
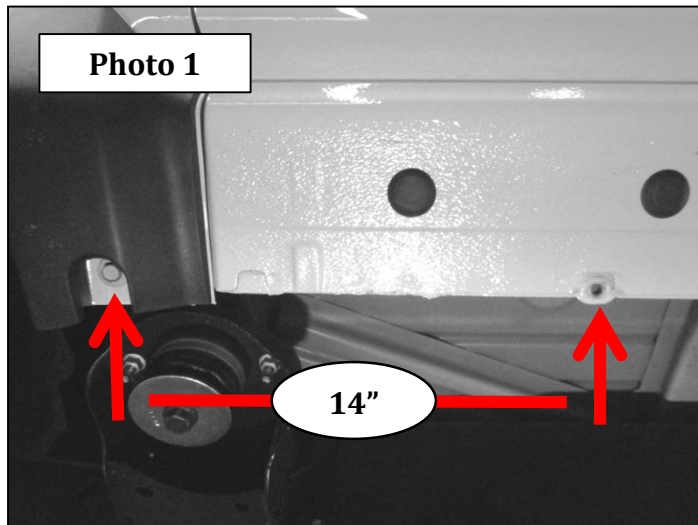

Step-2 Attach one of the driver side brackets to the rocker panel using the U-Nut, (1) M8 hex bolt, (1) 5/16" lock washer and (1) 5/16" flat washer, and to the pinch mold using (1) M8 hex bolt, (2) 5/16" flat washers, (1) 5/16" lock washer, and (1) M8 hex nut. Leave the nut and bolts loose for final adjustment, (**Photo 3**).

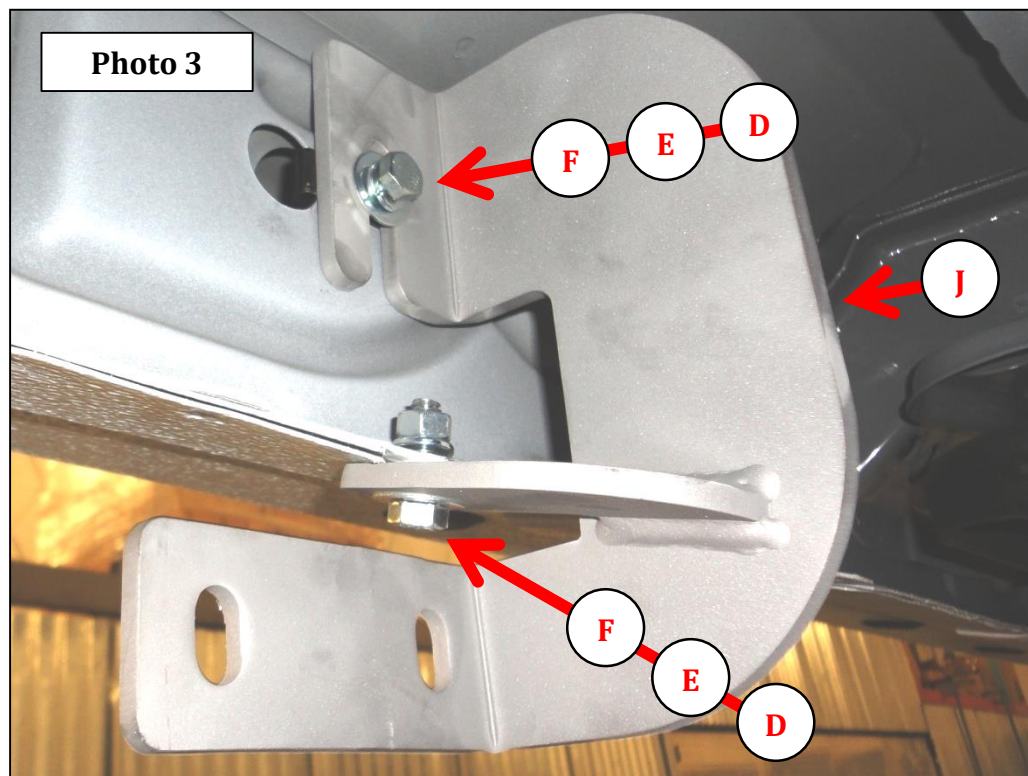

GO RHINO®

INSTALLATION INSTRUCTIONS

Step-3 Locate the hole in the body pinch mold and the plastic plug in the rocker panel for the center and rear mounting brackets. Measure rearward from the front fender bolt approximately 37 3/4" for the center and 67" for the rear bracket. Repeat **Step 2** to install the center and rear brackets.

Step-4 Insert three of the Nut-Plates through the rectangular opening in the back of the Dominator D1 side step. Measure and position each Nut-Plate so it aligns with one of the three mounting brackets previously attached to the vehicle, (Photo 4).

Photo 4

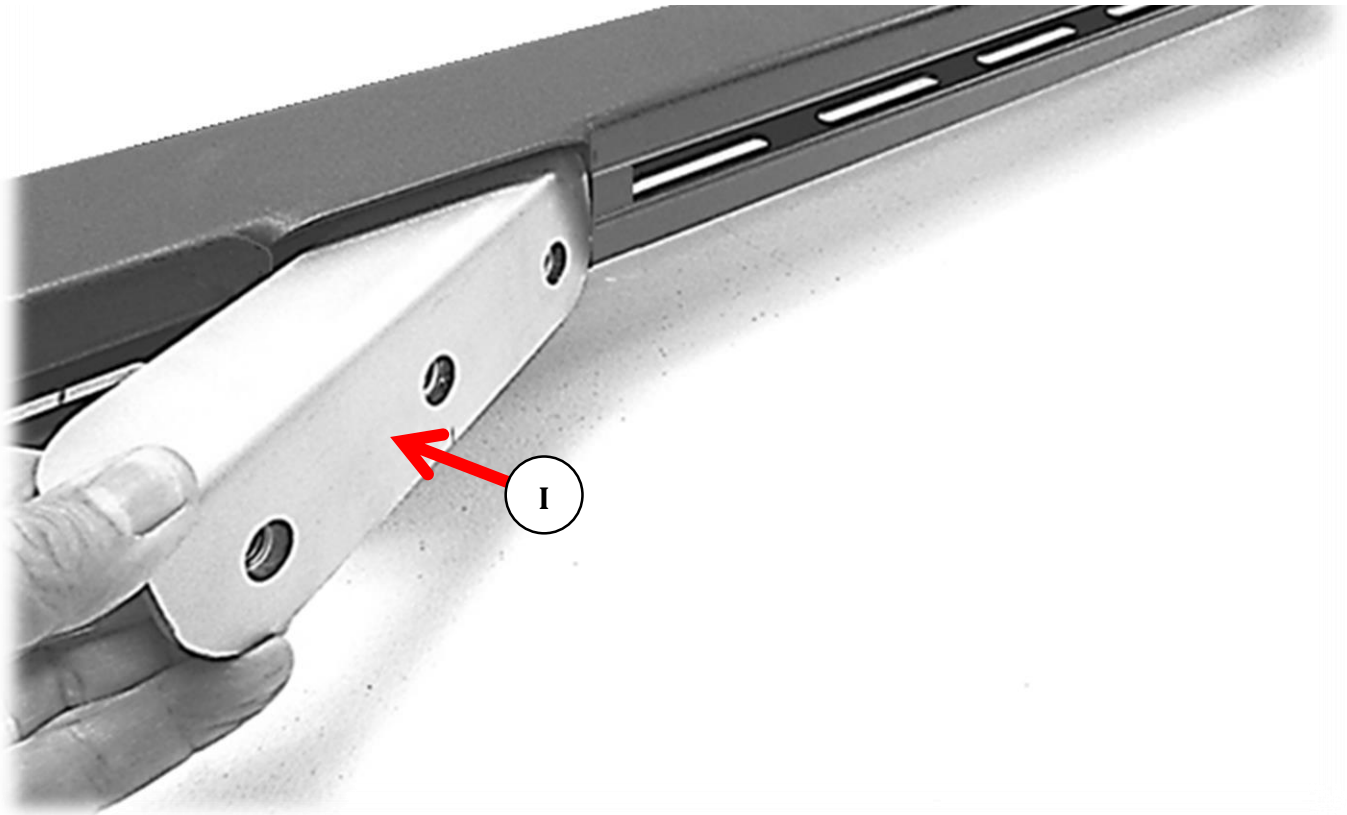

GORRHINO®

INSTALLATION INSTRUCTIONS

Step-5 Attach the Dominator D1 side step to each bracket using (2) 3/8" x 1 1/4" hex bolts, (2) 3/8" lock washers, (2) 3/8" flat washers, and (1) Nut-Plate (Photo 5).

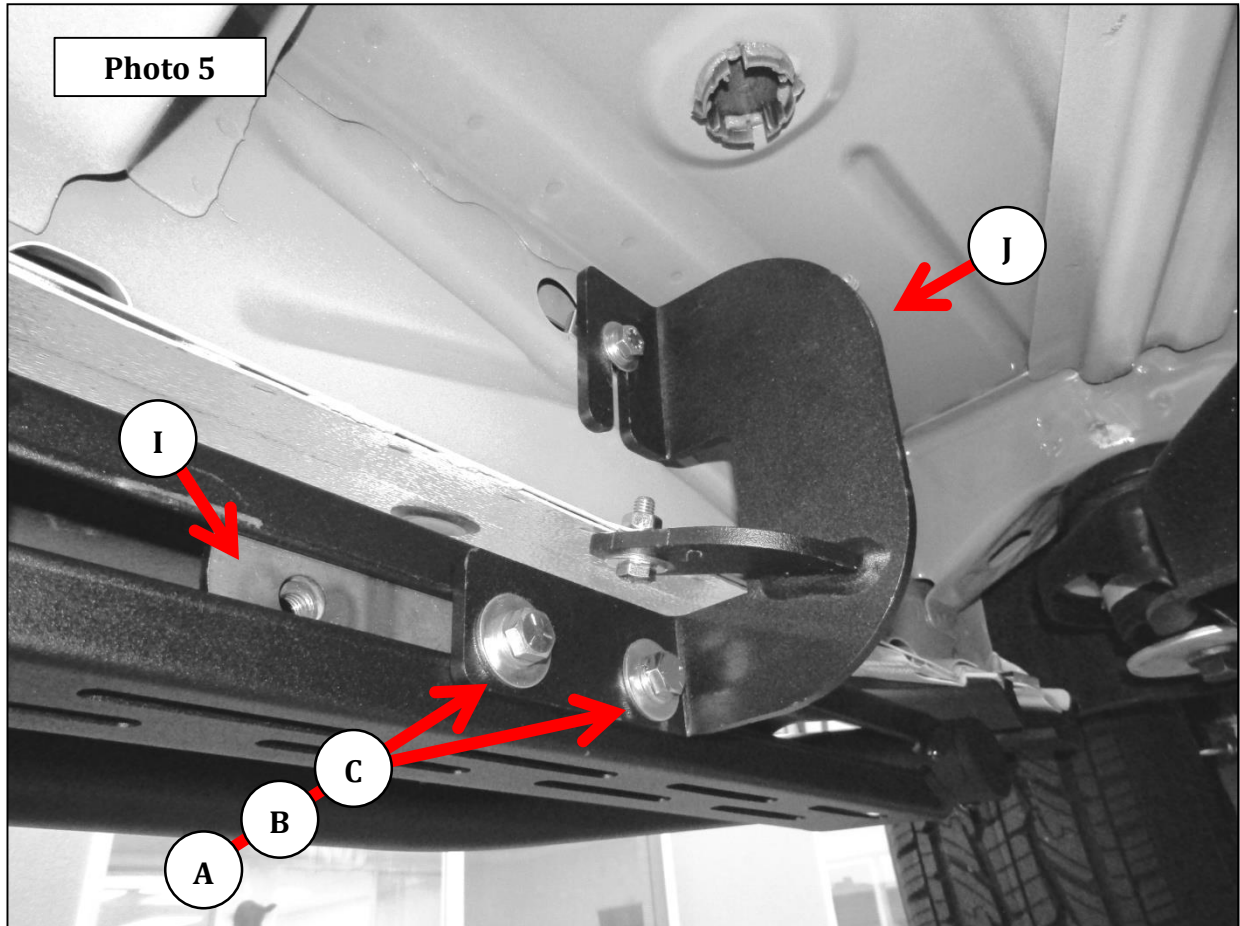

Step-5 Align the Dominator D1 side step with the vehicle and tighten all bracket and side step nuts and bolts. Repeat the above steps to install the passenger side brackets and Dominator D1 side step.